



County of Monterey **RECOMMENDED BUDGET**

Fiscal Year Ending June 30th

2024



Table of Contents

Distinguished Budget Presentation Award - - - - 6	Courier 206
County Resident Organization Chart- - - - - 21	Mail 207
Executive Summary - - - - - 23	Economic Development Administration . . 208
Appropriation Limits - - - - - 55	Laguna Seca Recreational Area 209
Recommendations - - - - - 57	Emergency Operations Center 210
Fund Structure - - - - - 59	CAO Non-Departmental 211
Three Year Forecast - - - - - 61	Contributions - Proposition 172 213
Strategic Initiatives - - - - - 99	Contributions-Other Agencies. 214
General Financial Policies- - - - - 103	Trial Courts 215
Schedules- - - - - 121	Contingencies 216
Countywide Position Summary - - - - - 149	County Memberships 217
Board of Supervisors - - - - - 171	Medical Care Services. 218
Emergency Management - - - - - 175	Other Financing Uses 219
Emergency Management 180	Other General Expenditures 220
Emergency Operations Center 181	Non-Program Revenue 221
DEM Grants 182	Homeland Security Grant 222
County Administrative Office - - - - - 183	Auxiliary Services. 223
CAO Departmental 191	Vehicle Replacement Planning 224
Administration & Finance. 193	Enterprise Resource Planning 225
Budget & Analysis 194	Development Set-Aside. 226
Contracts/Purchasing. 195	Inclusionary Housing 227
Intergovernmental & Legislative Affairs . 196	Revolving Loan Program 228
Cannabis 197	Community Development Reuse 229
Sustainability. 198	Boronda HS-A. 230
Office of Emergency Services. 199	Castro/Paj HS-A 231
Office of Community Engagement & Strategic Advocacy . . 200	Building Improvement and Replacement . 232
Fleet Administration 201	Equipment Replacement 233
Shuttle 202	Pension Liability Fund 234
Records Retention 203	Human Resources - - - - - 235
Workforce Development Board 204	Human Resources Departmental 241
Rifle Range 205	Employee & Labor Relations 242
	Employment Services 243
	Employee Benefits 244
	Human Resources Administration 245
	HR Information System 246
	Human Resources Non-Departmental 247
	Dental 249
	Vision 250
	Employee Assistance Program 251
	Disability 252
	Unemployment 253
	Misc Benefits. 254
	Other Post-Employment Benefits 255

Civil Rights Office - - - - -	257
Auditor-Controller - - - - -	263
Auditor-Controller Departmental	269
Auditor Controller	270
Disbursements	271
Systems Management	273
General Accounting	274
Internal Audit	275
Auditor-Controller Non-Departmental	276
PIC Debt Service	277
Annual Audits	278
Treasurer-Tax Collector - - - - -	279
Property Tax	284
Revenue	285
Treasury	286
Assessor-County Clerk-Recorder - - - - -	287
Assessor	292
Clerk/Recorder	294
Clerk/Recorder	295
County Counsel - - - - -	297
County Counsel Departmental	302
Legal Division	303
Risk Management Division	304
County Counsel Non-Departmental	305
Grand Jury	306
General Liability	307
Workers Compensation	308
Enterprise Risk	309
Clerk of the Board - - - - -	311
Assessment Appeals Board	315
Clerk of the Board	316
Elections - - - - -	317
Emergency Communications - - - - -	323
Emergency Communication	328
NGEN Operations & Maintenance	329
Emergency Communications	330

Information Technology - - - - -	333
ITD Administration	339
Applications	340
Service Delivery	342
Infrastructure	343
Security	345
Information Technology	346
IT Capital Projects	347
District Attorney - - - - -	349
Civil	354
Criminal	355
Criminal	357
King City	358
Child Support Services - - - - -	359
Public Defender - - - - -	365
Alternate Defender's Office	370
Public Defender	371
Public Defender	373
Sheriff-Coroner - - - - -	375
Civil	382
Professional Standards	383
Records and Warrants	384
Custody Administration	385
Court Services	386
Court Services	387
Transportation	388
Jail Operations and Administration	389
Jail Operations and Administration	391
Inmate Programs	392
Enforcement Operations and Administration	393
Enforcement Operations and Administration	395
Coroner & Investigation	396
Coroner & Investigation	397

Narcotics	398	Special Districts Administration	466
Community Services and Special Enforcement . .	399	Park Operations	467
Administration and Indirect Costs	401	Stormwater Floodplain Management.	469
Inmate Medical Program	403	Roads & Bridges	470
Probation - - - - -	405	Road & Bridge Maintenance	472
Alternative Programs	412	Fish & Game Propagation	473
Alternative Programs	413	East Garrison Public Financing Authority . .	474
Juvenile Hall	414	East Garrison Community Service District . .	475
Youth Center	416	Capital Projects	476
Youth Center	418	Capital Projects	477
Adult Probation	419	Nacimiento Lake & Resort Operations	478
Adult Probation	421	Community Service Areas	479
Juvenile Probation	422	Community Service Districts.	480
Juvenile Probation	423	Administration	481
Probation Administration	424	Records Retention	482
Agricultural Commissioner- - - - -	425	Courier	483
Housing and Community Development - - - -	431	Mail	484
Administration	437	Fleet Administration.	485
Community Development	438	Rifle Range	486
Inclusionary Housing.	440	Laguna Seca.	487
Community Development Reuse	441	Vehicle Replacement	488
Community Development Grant	442	Health - - - - -	489
Castroville/Pajaro Housing Set-Aside	443	Clinic Services Administration	501
Boronda Housing Set-Aside.	444	Alisal Health Center.	502
East Garrison Developer Reimbursements . .	445	Clinic Services NIDO clinic	503
Habitat Management	446	Laurel Family Practice.	504
Fort Ord Housing Set-Aside	447	Laurel Internal Medicine	505
East Garrison Housing Set-Aside	448	Laurel Pediatrics	506
Public Works, Facilities, and Parks- - - - -	449	Marina Health Center.	507
County Disposal Sites	461	Seaside Family Health Center	508
Facilities Maintenance	462	Ambulance Service	509
Utilities.	464	EMS Operating	510
Litter Control	465	Uncompensated Care	511
		Consumer Health Protection Services	512

Recycling and Resource Recovery Services . . .	513	Community Action Partnership	554
Land Use	514	Community Programs	555
Hazardous Materials & Solid Waste Management . . .	515	IHSS Public Authority	556
Environmental Health Fiscal and Administration . . .	517	Military & Veterans Services	557
Public Guardian/Administrator/Conservator .	518	Social Services	558
Children's Medical Services	519	Area Agency on Aging	560
Community Health Regional Teams	521	Social Services Realignment	561
Public Health	522	Protective Services	562
Drinking Water Protection	524	Office for Employment Training	563
Behavioral Health	525	Library - - - - -	565
Behavioral Health	526	Cooperative Extension Service - - - - -	569
Behavioral Health	528	Cooperative Extension	574
Health Realignment	529	Cooperative Ext -Reimbursed Projects	575
Health Dept. Administration	530	Natividad Medical Center - - - - -	577
Animal Services	532	Natividad Medical Center	585
Bienestar Salinas	533	Natividad Medical Center	588
Marina Integrative Clinic	534	Contributions/Obligations, Liabilities and Other -	589
Laurel Vista	535	Capital Budget Summary - - - - -	607
Clinic Services Quality Improvement	536	Debt Management Policy - - - - -	613
Customer Service Center	537	Annual Work Program for Road Fund - - - -	633
Whole Person Care	538	Budget Development Process - - - - -	637
CS Administration	539	Budget Reporting and Development Schedule - -	639
FQHC Clinics	541	Glossary of Terms - - - - -	643
Social Services - - - - -	543	Glossary of Acronyms - - - - -	647
CalWORKS/TANF	550	Glossary of Funds - - - - -	651
General Assistance	551		
IHSS Wages/Benefits	552		
Out of Home Care	553		



RECOMMENDED BUDGET

**COUNTY OF MONTEREY
INCLUDING
SPECIAL DISTRICTS GOVERNED
BY THE
BOARD OF SUPERVISORS**

**FISCAL YEAR ENDING
JUNE 30, 2024**

LUIS A. ALEJO (CHAIR)
GLENN CHURCH (VICE CHAIR)
CHRIS LOPEZ
WENDY R. ASKEW
MARY L. ADAMS

SONIA M. DE LA ROSA
COUNTY ADMINISTRATIVE OFFICER

1ST DISTRICT
2ND DISTRICT
3RD DISTRICT
4TH DISTRICT
5TH DISTRICT

Distinguished Budget Presentation Award

The Government Finance Officers Association of the United States and Canada (GFOA) presented an award for Distinguished Budget Presentation to the County of Monterey, California for the annual budget for the fiscal year beginning July 1, 2022. In order to receive this award, a government unit must publish a budget document that meets program criteria as a policy document, as an operational guide, as a financial plan, and as a communication device.

The award is valid for a period of one year. The FY 2023-24 Recommended Budget continues to conform to program requirements, and we are submitting it to GFOA to determine its eligibility for another award.



GOVERNMENT FINANCE OFFICERS ASSOCIATION

Distinguished Budget Presentation Award

PRESENTED TO

**County of Monterey
California**

For the Fiscal Year Beginning

July 01, 2022

Christopher P. Morrill

Executive Director

County of Monterey Board of Supervisors

Mission Statement

The Mission of Monterey County is to Excel at providing Quality Services for the benefit of all Monterey County residents while developing, maintaining, and enhancing the resources of the region.



Luis A. Alejo - District 1

168 W Alisal St, 2nd Floor
Salinas, CA 93901
(831) 755-5011

District1@co.monterey.ca.us

Glenn Church - District 2

11140 Speegle St
Castroville, CA 95012
(831) 755-5022

District2@co.monterey.ca.us



Chris Lopez - District 3

168 W Alisal St, 3rd Floor
Salinas, CA 93901
(831) 755-5033

District3@co.monterey.ca.us

Wendy Root Askew - District 4

2616 First Ave
Marina, CA 93933
(831) 755-5044

District4@co.monterey.ca.us



Mary L. Adams - District 5

1200 Aguajito Rd, Suite 1
Monterey, CA 93940
(831) 755-5055

District5@co.monterey.ca.us

ABOUT THE COVER



This year's Recommended Budget Book features images from the 2nd Supervisorial District of Monterey County.

1. **Olson Ranch Barn** - This barn and corral is part of the historic Olson Ranch in Prunedale, founded in 1892 as a cattle ranch. Many evolutions later, the ranch is now a vineyard, growing pinot noir and chardonnay grapes and producing award-winning wine, and is still owned and maintained by the Olson family.

Photo credit: Kathryn McKenzie

2. **Moss Landing Harbor** - Sailboats, houseboats and many other types of watercraft inhabit Moss Landing Harbor, providing a colorful backdrop to this coastal village. Moss Landing is also a center of important marine exploration and study, with Monterey Bay Aquarium Research Institute (MBARI), California State Universities' Moss Landing Marine Lab and other research groups located there.

Photo credit: Kathryn McKenzie

3. **Royal Oaks Park** - Native live oaks frame the entrance to Royal Oaks Park, the first to be established in the Monterey County Parks system. The park offers picnic sites, a playground, trails for walking and horseback riding, and other amenities.

Photo credit: Kathryn McKenzie

4. **Boronda** - This archway marks the historic Boronda area of west Salinas, originally part of a Spanish land grant given to José Eusebio Boronda in 1840. Boronda built a colonial-style adobe home there, which has been preserved and is now a museum of local history and is a California Historical Landmark.

Photo credit: Kathryn McKenzie

5. **Castroville** - Downtown Castroville pays homage to its agricultural roots with this arch. The North Monterey County community of Castroville is truly the Artichoke Center of the World, with its neighboring fields producing 75% of the California artichoke crop, according to the California Artichoke Advisory Board.

Photo credit: Kathryn McKenzie

6. **Elkhorn Slough** - Old dairy barns line a hillside at Elkhorn Slough National Estuarine Research Reserve, an important wetlands area that was previously the site of North Monterey County's dairy industry for more than a century. The reserve is now a federally protected area that is a favorite spot for bird watching and hiking.

Photo credit: Kathryn McKenzie

Fiscal Year 2023-24 Recommended Budget

Submitted by
Sonia M. De La Rosa, County Administrative Officer



Prepared by
County Administrative Office
Budget and Analysis Division

Dewayne Woods, Assistant County Administrative Officer
Ezequiel Vega, County Budget Director

Juan Pablo Lopez
Administrative Analyst
Natividad Medical Center
Water Resources Agency
Public Works, Facilities and Parks
Capital Asset ISF Management
Human Resources
System Lead
Training Lead
Debt Issuance
Fund Balance Reconciliation
Budget Book Production
Staff to Capital Improvement Committee

Raquel Escorcía
Administrative Analyst
Emergency Communications
Agricultural Commissioner
Cooperative Extension
Elections
Child Support Services
Library
Prop 172 Forecast

Veronica Fernandez
Administrative Analyst
Auditor-Controller
Treasurer-Tax Collector
Board of Supervisors
County Counsel/Risk Management
Health Department
Assessor/Clerk-Recorder
Clerk of the Board

Bella Lesik
Administrative Analyst
Probation
Public Defender
Sheriff-Coroner
District Attorney
Civil Rights Office

Ezequiel Vega
County Budget Director
Countywide Budget & Fiscal Oversight
County Policy Review and Analysis
Staff to Budget Committee
County Administrative Office
Department of Emergency Management

Lucila Sanchez
Administrative Analyst
Department of Social Services
Military & Veterans' Affairs Office
Housing and Community Development
Information Technology
Labor Fiscal Analysis

Rocio Quezada
Executive Support Staff
Budget Committee Support Staff
Capital Improvement Committee
Support Staff
Budget Workshops Coordinator
Budget Hearings Coordinator

Cover Design by:
Supervisorial District 2
Layout Design by: Bella Lesik

Budget Committee:
Chair, Supervisor Chris Lopez
Vice-Chair, Supervisor Glenn Church

Special Thanks to:
County Department Heads
Department Finance Managers/Staff

About Monterey County



Monterey County Quick Facts	
Square Miles	3,771
Coastline Miles	99
Number of cities	12
Number of road miles maintained	1,261.67
Number of bridges maintained	175
Number of County library branches	17
Number of hospitals	4
Number of County Parks	9
Number of State Parks/Beaches	18

Sources: Monterey County Economic Development Department, Public Works, Facilities & Parks, Library, seemonterey.com, and MTYCounty.com

Population

Monterey County is one of 58 counties in the State of California and part of the Salinas, CA Metropolitan Statistical Area. The California Department of Finance projects the County's population at 449,346 in 2023.

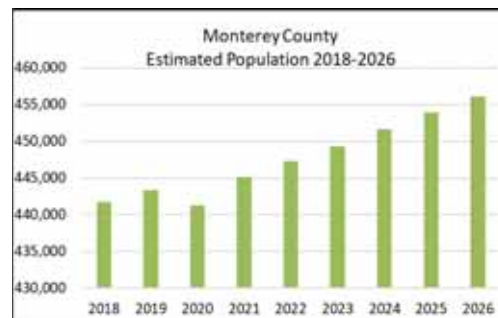

Source: State of California, Department of Finance, Report P-2A: State & County Population, March 2021

In years 2024 and 2025, Monterey County's population is projected to grow at a rate of 0.5% year over year. Population growth projections for Monterey County are slightly higher than comparable counties of San Luis Obispo and Santa Barbara for the year 2023. The projected change in total population from 2022 to 2023 is 0.5% for Monterey County (447,300 to 449,346) whereas San Luis Obispo and Santa Barbara's projected change in population are 0.3% and 0.4% respectively.

Monterey County is located on the breathtaking Pacific Coast of California, south of San Francisco and north of Los Angeles. The County is comprised of 3,771 square miles and includes 12 incorporated cities and 16 unincorporated areas. The City of Salinas is the largest municipality and serves as the County's seat.

Established in 1850, Monterey County was one of the original counties of California at the time of statehood. The County derived its name from the Monterey Bay, which was named by Sebastian Vizcaino in 1602, in honor of Gaspar de Zuniga y Acevedo, Conde de Monterey, the Viceroy of New Spain. The word itself is composed of the Spanish word's "monte" and "rey", which literally means "king of the mountain."

Monterey County is known to the world for its majestic coastlines including Big Sur, California State Route 1, and 17-Mile Drive on the Monterey Peninsula, as well as the agriculturally rich Salinas Valley, also known as the "salad bowl of the world." Monterey is also home to Pinnacles National Park near the City of Soledad, the Monterey Bay Aquarium and the site of a Monarch butterfly preserve in the City of Pacific Grove.



Source: State of California, Department of Finance, Report P-2A: State & County Population, March 2021

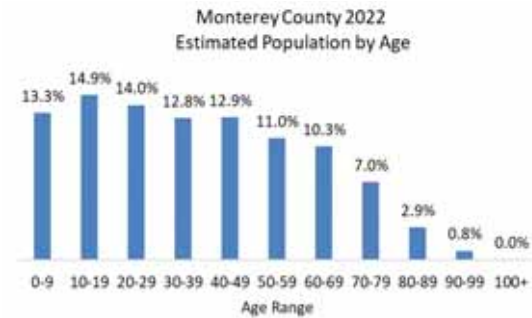

Source: State of California, Department of Finance, Report P-2B: State & County Population, July 2021

Salinas is the largest city in Monterey County with over 159,932 residents. The cities of Marina, Soledad, Monterey, and Seaside form the second largest group in population ranging from 21,457 to 32,068 residents each. The smallest cities include Sand City, Del Rey Oaks Carmel-by-the-Sea and Gonzales with populations ranging from 372 to 8,340. The population for the unincorporated areas of Monterey County is 104,851.

In 2023, the projected population by race in Monterey County consists of 60% Hispanic, 30% White, 5% Asian, 2% Black, 2% Multi-racial and 1% made up of other.

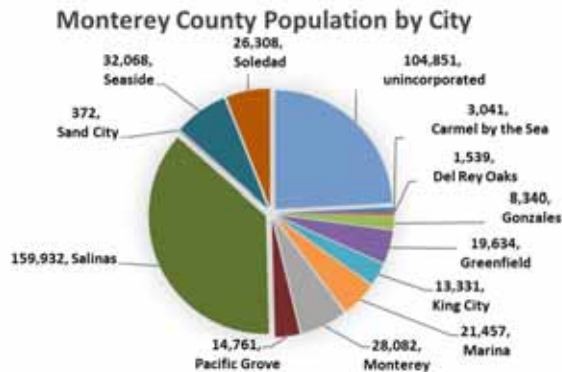

Source: State of California, Department of Finance E-1 Report, May 2022

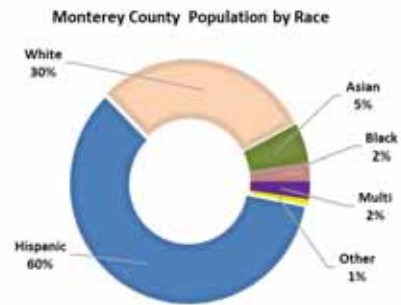

Source: State of California, Department of Finance P-2D Population Projections Report, March 2021

Monterey County’s residents under the age of 30 represent 42.2% of the total population. The next largest age group consists of adults between the ages of 30-59 comprising 36.7% of the population. Older adults ages 60 to 100+ make up the County’s smallest age group at 21.1%. The median age for Monterey County’s population is 34 years.

Income

Per capita income in Monterey County continues to be lower in comparison to the statewide average and that of nearby counties. In 2021, Monterey County had a per capita personal income of \$33,786 which is lower than the per capita income for California as a whole and neighboring counties of San Luis Obispo, Santa Clara, and Santa Barbara.

The Median Household Income in Monterey County is \$82,013 which is 2.5% below the statewide average and the lowest compared to neighboring counties.

Monterey County’s poverty level of 12.1% is lower than the statewide average of 12.3%, while San Luis Obispo County and Santa Clara County poverty levels both exceeded State level by 0.8% and 2.9% respectively.

Per Capita Income and Median household Income Selected Counties and California			
	Per Capita Income	Median Household Income	Persons in Poverty
Monterey County	33,786	82,013	12.1%
San Luis Obispo County	41,407	82,514	13.1%
Santa Barbara County	40,634	84,356	15.2%
Santa Clara County	65,052	140,258	6.9%
California	41,276	84,097	12.3%

Source: U.S. Census Bureau, QuickFacts 2022

Employment and Industry

Monterey County's economy is primarily based on tourism in the coastal regions and agriculture in the Salinas Valley. An extensive array of education and research institutions located in the County also contribute greatly to the economy. The non-profit sector is also one of the largest business sectors in the County.

The chart that follows lists the major employers in Monterey County.

Employer Name	Industry
Al Pak Labor	Labor Contractors
Azcona Harvesting	Harvesting-Contract
Bud of California	Fruits & Vegetables-Growers & Shippers
County- Monterey Behavioral	Diagnostic Imaging Centers
Filipino American Cmnty Club	Church Organizations
Fort Hunter Liggett Military	Military Bases
Growers Co.	Fruits & Vegetables & Produce-Retail
Hilltown Packing Co.	Harvesting-Contract
Mann Packing Co.	Fruits & Vegetables-Growers & Shippers
Mee Memorial Hospital	Hospitals
Middlebury Institute-Intl.	Schools-Universities & Colleges Academic
Misionero Vegetables	Fruits & Vegetables-Growers & Shippers
Monterey Bay Aquariums Rstrnt	Aquariums-Public
Monterey County Social Services Dept.	Government Offices-County
Monterey Peninsula College	Junior-Community College-Tech Institutes
Natividad Medical Center	Hospitals & Medical Centers
Pebble Beach Co	Hotels & Motels
Pebble Beach Resorts	Resorts
Premium Harvesting & Packing	Labor Contractors
Quality Farm Labor	Labor Contractors
RC Packing	Packing & Crating Service
Salinas Valley Memorial Healthcare	Health Care Management
US Defense Department	Government Offices-Federal
US Defense Manpower Data Center	Government Offices-Federal
Valley Harvesting	Crop Harvesting-Primarily By Machine

Source: America's Labor Market Information System (ALMIS) Employer Database, 2023 2nd Edition.
Note: Not ranked in order of employment size

Labor Force and Unemployment

2022 Annual Averages	
Labor Force	220,500
Employment	207,400
Unemployment	13,100
Unemployment Rate	5.9%

Source: California Employment Development Department Labor Market Information Division, Unemployment Rate and Labor Force Data March 2023

Monterey County's annual unemployment rate in 2021 was 8.4%. This compares with an annual unemployment rate of 7.3% for California during a period in which the world continued to experience the Covid-19 Pandemic. Monterey County's jobless rate remains higher than both the State and the nation.

Occupational Share of Employment for Monterey County		
Occupation	May 2021 Employment Estimates	1st Qtr. 2022 Mean Hourly Wage
Farming, Fishing, and Forestry	18.6%	\$17.03
Office and Administrative Support	9.1%	\$24.12
Transportation and Material Moving	8.3%	\$20.60
Food Preparation and Serving-Related	8.3%	\$18.66
Sales and Related	7.7%	\$22.25
Education Instruction and Library Occupations	7.1%	\$40.89
Healthcare Support	5.2%	\$19.18
Healthcare Practitioners and Technical	4.9%	\$61.78
Management	4.5%	\$57.96
Production	3.5%	\$21.21
Business and Financial Operations	3.5%	\$39.88
Protective Service	3.2%	\$37.59
Construction and Extraction	3.2%	\$31.36
Building & Grounds Cleaning & Maintenance	3.1%	\$20.34
Installation, Maintenance, and Repair	2.9%	\$28.38
Community and Social Services	1.6%	\$32.06
Personal Care and Service	1.4%	\$19.90
Computer and Mathematical	1.1%	\$49.12
Arts, Design, Entertainment, Sports, & Media	0.9%	\$33.58
Life, Physical, and Social Science	0.8%	\$45.13
Architecture and Engineering	0.5%	\$45.93
Legal	0.5%	\$56.78

Source: State of California Employment Development Department, Labor Market Division, June 2022

According to the State of California Employment Development Department's Labor Market Division, Monterey County's local economic strength lies in occupations that generally pay lower wages, explaining why the per capita income levels are relatively low compared to nearby counties. In Monterey County, 18.6% of the labor force consists of occupations in Farming, Fishing, and Forestry. In the first quarter of 2022, the mean hourly wage was \$17.03 per hour. The second highest occupational

category is Office and Administrative Support, accounting for 9.1% of the workforce with a mean wage of \$24.12 per hour. Transportation and Material Moving occupations represent the third largest share of Monterey County’s employment with 8.3% and a mean wage of \$20.60 per hour. The top three occupations in Monterey County represent 36% of all employment. Monterey County continues its efforts to attract more highly skilled jobs to the local economy by encouraging its residents to seek higher educational opportunities that will in turn create a more highly skilled labor force.

Education

The education system in Monterey County tasked with developing a skilled labor force primarily consists of a public school system headed by the Monterey County Office of Education (MCOE). MCOE was established more than 150 years ago by California’s Constitution and supports 24 school districts, two community colleges, and a state university.

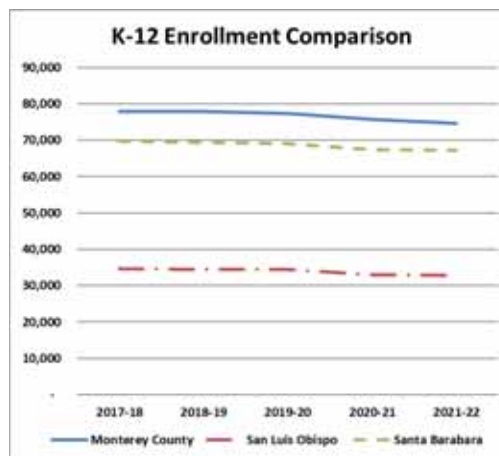

Source: California Department of Education

California schools saw an increase in revenues due to the passage of certain legislation including Proposition 30 and Proposition 55 which is alleviating the financial challenges of years past. The State’s implementation of a local control funding formula provides school district boards the flexibility on the use of funds. This funding formula increases the local responsibility for student achievement.

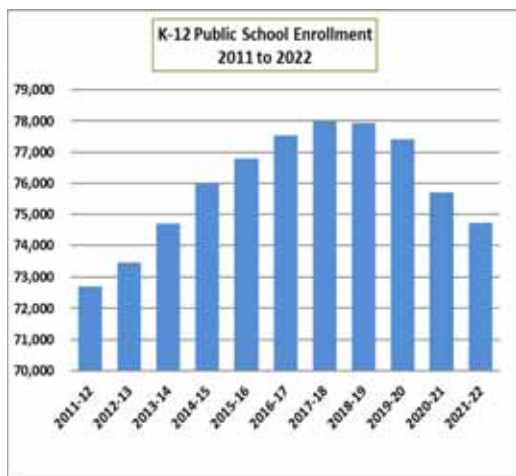

Source: California Department of Education

Enrollment in K-12 Public Schools in 2021-22 was 774,700 in Monterey County. After experiencing continuous declines in enrollment growth, Monterey County’s K-12 enrollment began growing steadily in 2009 with continued growth every year until 2018-19. Since then, enrollment in Monterey County has declined 1-2% each year. In 2021-22, enrollment declined 1.3% from the prior year.

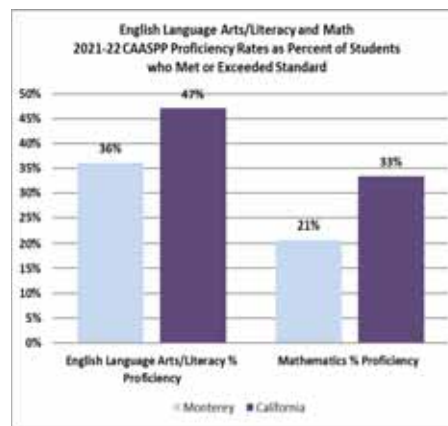

Source: California Department of Education.

Historically, educational attainment in Monterey County, along with other measures of educational performance, has lagged California and other Central Coast counties. The COVID-19 pandemic further impacted student academic achievement across the nation. In recent years, the percentage of students in Monterey County achieving levels of proficiency in English Language Arts/Literacy (ELA) and Math began increasing until 2021-22 when rates dropped below pre-pandemic levels. Statewide, the percentage of students meeting or exceeding

standards for ELA and math declined from 2018-19 levels. In 2021-22, 36% of students in Monterey County who tested met or exceeded standard for ELA compared to 21% who met or exceeded standard for math.

High School Graduation Rates 2019 to 2022				
County	2019	2020	2021	2022
Monterey	83.5%	84.5%	85.0%	88.5%
San Luis Obispo	91.0%	90.3%	89.5%	93.2%
Santa Barbara	86.8%	86.3%	89.5%	92.7%
California	84.5%	84.3%	83.6%	87.0%

Source: California Department of Education, Dataquest.

Although Monterey County has had lower graduation rates compared to neighboring counties, it has shown improvement over time. Since 2019, Monterey County's high school graduation rate has steadily increased from 83.5% to 88.5%. In 2022, the high school graduation rate for Monterey County was above the State rate of 87.0%.

Monterey County continues to make strides towards preparing its students for higher education. In 2019-20, the college going rate was 65.7% compared to the State's rate of 62.7% according to the California Department of Education. For Monterey County, the rate increased from the prior year by 3.3% while the state rate decreased 2.2%. Preparing students for higher education will allow them to take advantage of the vast educational opportunities available in the area.

Higher Education and Research Institutions

Monterey County is home to a range of institutions of higher learning, both public and private, large, and small, general, and highly focused institutions, particularly related to marine research. The higher education and research institutions located within Monterey County contribute to the local economy, including research and grant funding. Employing more than 15,000 faculty, staff and researchers directly employed by these institutions.

Institutions include:

- Brandman University
- Cabrillo College

- California Department of Fish & Wildlife (CDFW) Marine Region
- California State University, Monterey Bay
- Central Coast College
- Defense Language Institute, Foreign Language Center
- Defense Manpower Data Center
- Elkhorn Slough National Estuarine Research Reserve
- Fleet Numerical Meteorology & Oceanography Center, US Navy
- Golden Gate University
- Hartnell College
- Hopkins Marine Station
- Stanford University
- Monterey Bay Aquarium
- Monterey Bay Aquarium Research Institute (MBARI)
- Monterey College of Law
- Monterey Bay National Marine Sanctuary
- Monterey Institute of International Studies
- Monterey Peninsula College
- Moss Landing Marine Laboratories
- Pacific Fisheries Environmental Laboratory (National Oceanic & Atmospheric Administration (NOAA))
- Panetta Institute for Public Policy
- National Weather Service (NOAA)
- Naval Postgraduate School
- Naval Research Laboratory
- U.S. Geological Survey (USGS), Pacific Science Center
- University of California, Santa Cruz (UCSC)

Social Services

The need for government assistance has continued to grow in Monterey County, even while nearby regions have shown signs of decreased need. This trend has persisted for the past decade. Monterey County via its Social Services Department provides temporary public assistance benefits and services to assist eligible residents in meeting their basic needs.

One of the programs available to assist families is CalWORKS (California Work Opportunities and Responsibility for Kids) which is designed to assist families toward a path of work and self-sufficiency. It provides financial assistance to economically disadvantaged families. Monterey County has the highest yearly enrollment when compared to its neighboring counties.

CalWorks FY 2021-22		
Annual Applications Approved vs Denied		
County	Approved	Denied
Monterey	1,240	2,880
San Luis Obispo	393	688
Santa Barbara	854	2,242

Source: California Department of Social Services, CalWORKS Annual Summary November 2022
 * Cells that could identify an individual with a value of less than 11 have been replaced with a (*) to comply with the CDSS Data De-identification Guidelines.

Another program the County administers is CalFresh (Formerly named Food Stamps). CalFresh supplements the food budget of low-income households to meet their nutritional needs. The amount of help is based on household size, family income and resources. The available data shows that Monterey County has the second highest average number of participating households compared to San Luis Obispo County and Santa Barbara County.

CalFresh 2022	
County	Household Average Participation
Monterey	22,757
San Luis Obispo	13,892
Santa Barbara	30,087
California	2,787,764

Source: CalFresh Participation & Benefit Issuance Report (DFA 256)

The table that follows contains information regarding health care, social and economic factors, and physical environment for Monterey County.

Monterey County Snap Shot		
	Monterey	California
Health Care		
Uninsured adults	16%	11%
Uninsured children	4%	4%
Life expectancy	82.2	81.0
Social & Economic Factors		
Children in poverty	15%	15%
Homicides (per 100,000 population)	8	5
Physical Environment		
Air pollution-particulate matter	7.3	12.9

Source: County Health Rankings 2022

Agriculture



Monterey County is one of the nation's top agricultural producers of the State. Agriculture is the County's largest sector in terms of economic output and employment. As such, it represents a vital link to both the County's cultural past and competitive future. Agriculture touches nearly every facet of life in Monterey County. From lettuce in the Salinas Valley, artichokes in Castroville, berries in north Monterey County, or vineyards in Carmel Valley, agriculture shapes our lives. Unlike most agriculture across the United States that is machine harvested, the crops grown in Monterey County are dependent upon a highly skilled labor force to produce the fresh fruits and vegetables that feed the nation and keep us healthy.

Most agricultural companies based in Monterey County are family-owned and operated. The 2021 Crop and Livestock report produced by Monterey County reported a production gross value of over \$4.1 billion in crop farming, which was an increase of 4.8% from 2020. The report notes the increase in value in some crops while others decreased and highlights the diversification of growing many different crops and the beneficial impact this lends to the Agricultural Industry in Monterey County.

Gross Production Value		
Categories	2021 Total Value	2020 Total Value
Vegetable Crops	\$ 2,568,381,000	\$ 2,524,608,000
Fruit & Nuts	\$ 1,285,767,000	\$ 1,124,737,000
Nursery Crops	\$ 99,778,000	\$ 119,836,000
Livestock & Poultry	\$ 113,434,000	\$ 110,891,000
Field Crops	\$ 28,093,000	\$ 26,100,000
Seed Crops & Apiary	\$ 4,787,000	\$ 4,582,000
TOTAL:	\$ 4,100,240,000	\$ 3,910,754,000

Source: Monterey County Crop Report 2021

While Monterey County is known as “The Salad Bowl of the World” due to its diversity in crops, Vegetable Crops, which include lettuce and other produce, continue to rank highest in gross production value. In 2021, Vegetable Crops placed above other crops for production with a gross value of \$2.6 billion.

The Economic Contributions of Monterey County Agriculture report published June 2020 showed that in 2018 local agriculture accounted for more than 63,921 jobs in Monterey County. with 57,503 being direct employees and 6,417 additional jobs made possible through expenditures by agricultural companies and their employees. The report also noted one in five jobs in Monterey County was directly attributable to the agricultural industry.

Monterey’s agriculture contributes a total of \$11.7 billion in economic output. The \$11.7 billion in economic output consists of \$7.4 billion (19.7% of the county’s total 2018 economic output) in direct economic output and \$4.3 billion in additional economic output in the form of multiplier effects, over \$31.0 million dollars per day.

Monterey County farmers are among the most productive and efficient in the world growing more than 150 crops. The table that follows shows that the top two crops in 2021 were strawberries and leaf lettuce as in the prior year.

Monterey County's Top Crops			
Crops	2021 Crop Value	2021	2020
		Crop Ranking	Crop Ranking
Strawberry	\$ 968,086,000	1	1
Leaf Lettuce	\$ 741,598,000	2	2
Head Lettuce	\$ 451,556,000	3	3
Broccoli	\$ 309,490,000	4	4
Wine Grape	\$ 218,591,000	5	12
Spinach	\$ 173,882,000	6	6
Cauliflower	\$ 155,983,000	7	5
Celery	\$ 146,641,000	8	9
Livestock & Poultry	\$ 113,434,000	9	10
Brussels Sprout	\$ 105,616,000	10	8
Nursery & Flower	\$ 99,778,000	11	7
Misc. Vegetables	\$ 85,059,000	12	11
Mushroom	\$ 78,327,000	13	13
Raspberry	\$ 43,568,000	14	17
Spring Mix	\$ 43,268,000	15	23
Artichoke	\$ 43,018,000	16	19
Cabbage	\$ 38,463,000	17	14
Lemon	\$ 35,604,000	18	16
Carrot	\$ 31,882,000	19	20
Peas	\$ 29,516,000	20	15
Garlic	\$ 29,223,000	21	25
Onion, Dry	\$ 25,766,000	22	18
Rangeland	\$ 21,922,000	23	21
Blackberry	\$ 13,305,000	24	22
Chard	\$ 12,045,000	25	26
Kale	\$ 12,019,000	26	24

Source: Monterey County Crop Report 2020

Cannabis Production value totaled \$618.2 million in 2021, an increase of \$134.1 million over the prior year.

Cannabis Production Value	
Year	Total Value
2021	\$ 618,193,000
2020	\$ 484,102,000

Source: Monterey County Crop Report 2021

Cannabis production includes nursery products, flower (mixed light), flower (indoor), trim and seed.

Cannabis

In 2015, the Board of Supervisors adopted an ordinance allowing cannabis cultivators to utilize greenhouse space for cultivation. Soon several cities throughout the County followed with their own ordinances limiting cultivation to indoor facilities and greenhouse including regulations and tax structures. The vast majority of cultivation takes place in the unincorporated area of the County.

Since then, the Board of Supervisors has approved reductions to cannabis tax rates.

Since FY 2017-18 annual tax revenue to the County has increased from \$14.6 million to \$20.1 million in FY 2020-21. In FY 2021-22, revenues decreased sharply totaling \$9.1 million.

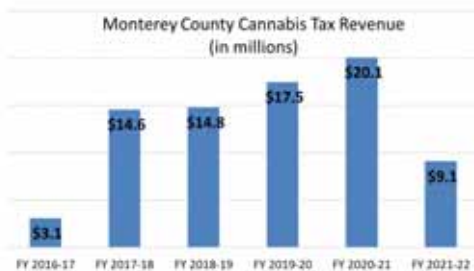

Hospitality

Monterey County has long been a tourist destination attracting an estimated 3.9 million overnight visitors in 2021. While effects of the pandemic are still visible, demand for travel in Monterey County was positive with travel related spending rebounding 66% from 2020 according to the Monterey County Travel Impacts report published in May 2022. The 2021-22 Monterey County convention & Visitors (MCCVB) annual report noted a \$614.0 million incremental increase in travel spending, a 25% room demand, and 6,092 room nights booked for group meetings that resulted in a \$4.4 million economic impact in Monterey County.

The County has a worldwide reputation with widely recognized destinations such as Big Sur, Pebble Beach, Carmel-by-the-Sea, and Monterey – and attractions such as Monterey Bay Aquarium, National Steinbeck Center, 17-Mile Drive, Cannery Row, Fisherman’s Wharf, Pinnacles National Park, and the Monterey Wine Country.

Visitors enjoy a wide variety of recreational activities including: golf, beaches, scuba diving, sailing, kayaking, whale watching, fishing, camping, horseback riding, skydiving, hiking, biking, art galleries, exhibits, music, and theatre. Nearly 300 special events take place in Monterey County annually, including AT&T Pebble Beach Pro-Am

Golf Tournament, Monterey Jazz Festival, races at WeatherTech Raceway Laguna Seca, Concours d'Elegance, Big Sur Marathon and other food, wine, cultural and family festivals.



COUNTY DEPARTMENT SPOTLIGHT

DEPARTMENT OF HOUSING AND COMMUNITY DEVELOPMENT



The Department of Housing and Community Development (HCD) is located at 1441 Schilling Place, 2nd Floor, Salinas, CA 93901. The Permit Center is open Monday – Friday from 8:00 a.m. to 4:00 p.m. HCD also has an online presence (<https://www.co.monterey.ca.us/government/departments-a-h/housing-community-development>) where its services may be accessed at any time. Customers may also contact HCD’s call center at (831) 755-5025 from 8:00 a.m. to 5:00 p.m. Monday through Friday.

The mission of HCD is to bring together a range of land use and construction related services to ensure reasonable and safe development, plan for the future needs of the County, manage infrastructure and County facilities, and protect natural resources. The vision of HCD is to enhance the quality of life and

economic health of the community by providing responsive, efficient, and high-quality public services and to promote good stewardship of natural and man-made resources.

Executive staff are Erik V. Lundquist, Director; Craig Spencer, Chief of Planning; Joshua Bowling, Chief of Building Services; Elizabeth Gonzales, Permit Center Manager (WOC); and Melissa McDougal, Administrative Secretary. Key management staff are Evan Knuckles, Building Services Manager; Armando Fernandez, Senior Civil Engineer; Luis Rodriquez, Associate Hydrologist; Darby Marshall, Housing Program Manager; Melanie Beretti, Principal Planner; Anna Quenga, Principal Planner; Johanna Dy, Supervising Office Assistant; and Lori Woodle, Finance Manager.

The Department has four Divisions: Development Services, Planning Services, Permit Center and Administrative Support. Administrative Support provides budget, accounting, customer service, human resources, safety, secretarial support, and information. Development Services includes three sections: Building Services, Environmental Services, and Engineering Services. Planning Services is composed of three sections: Advance Planning, Current Planning, and Housing. The Permit Center provides single point of contact and processing guidance for planning and construction related permits. The Permit Center also manages public records and the call center.

History of Program

The County’s planning functions began in the 1930s with the adoption of the County’s subdivision ordinance (Ord. 374) and zoning ordinance (Ord. 377). The initial zoning ordinance was brief and enumerated a few regulations. By mid-1970’s, the Zoning Ordinance had evolved into a more complex set of regulations. In 1981, the zoning ordinance was significantly reformatted, and the number of different zones were reclassified into the districts that are essentially effective today (Monterey County Code Titles 20 and 21). Along the way new uses were accommodated such as telecommunications

and new standards were adopted to address environmental impacts.

Organizationally the Planning Department functioned independently until merged with other County functions into the retitled Resource Management Agency (RMA). On September 29, 2020, the Board of Supervisors adopted Ordinance No. 5342 dissolving the RMA and creating two new departments: Housing and Community Development Department and Community Services Department, now Public Works Facilities and Parks Department. The first General Plan was adopted in 1968. In the early and mid-1970s federal and state funds were generally available to update general plans. This funding, coupled with laws that required the updating of general plans, and the State’s mandate to include several new “elements” in general plans led to significant amendments to the County’s General Plan during 1982. Subsequently, amendments to the General Plan enacted Area and Land Use Plans for specific geographic areas within the inland and coastal unincorporated areas. A comprehensive update to the General Plan was adopted on October 26, 2010, which only applies to the inland areas. The Coastal Land Use Plans, together with the Coastal Implementation Plans for each of the coastal areas comprise the County’s Coastal Implementation Plan originally certified by the Coastal Commission in 1988. The 1982 General Plan still applies in the coastal zone.

The County’s first building functions began in 1954 with the adoption of the first Building Ordinance, which was substantially expanded in 1961.



Planning Services

The mission of HCD Planning is to provide high-quality customer service in the areas of land use, development and resource protection to residents and business operators throughout the unincorporated areas of Monterey County. HCD Planning consists of three divisions:

Current Planning - Responsible for reviewing land use and development proposals and permit requests for consistency with the County's adopted land use policies and regulations and taking the appropriate action on these requests.

Advance (Long Range) Planning - Responsible for creating and implementing the County's development policies and regulations, primarily through the administration of the General Plan, Community Master Plans and the Zoning Ordinance.

Housing Programs - Dedicated to creating fair housing for all in thriving and inclusive neighborhoods. The unit was established as the County's public housing authority and is the lead agency for housing programs.

Development Services

The mission of HCD Development Services is to promote economic vitality and enhance the quality of life for the people of Monterey County. HCD Development Services consists of the following divisions:

- Building Services
- Environmental Services
- Engineering Services

The Building Services team reviews project plans and supporting documentation to ensure that California Building Codes and County of Monterey Code regulations have been incorporated into the proposed project. The team performs routine inspections to confirm that all completed work is to the approved plans and assists the customer through the process of construction. The team also responds to and investigates complaints of violations regarding State and County building, zoning, housing, and grading codes/ordinances and works

with the owners to bring their properties into compliance.

The **Environmental Services** team consolidates regulatory land use oversight for Monterey County Grading and Erosion Control ordinances, the Federal Emergency Management Agency (FEMA) National Flood Insurance Program, the FEMA Community Rating System, and the Phase II MS4 General Permit. Environmental Services staff conducts site inspections to ensure compliance Federal, State, and local regulations, as well as, assist the public with drainage inquiries. Environmental Services also provides floodplain mapping services such as flood zone determination reports, and is the repository for FEMA Elevation Certificates, FEMA Letter of Map Changes, Flood Insurance Studies, and Flood Insurance Rate Maps.

Engineering Services is responsible for ensuring that new development projects comply with applicable regulations and provide the necessary public infrastructure including, but not limited to:

- Streets
- Sidewalks
- Storm and sanitary sewers
- Traffic improvements

In addition to reviewing, approving and inspecting the public infrastructure necessary for new development, our division is also responsible for the following:

- Encroachment Permits
- Extra-Legal Load Permits



Permit Center

The Housing and Community Development (HCD) Permit Center manages front counter operations, including permit processing, and provides general support services (reception, call center, cashier, records, scanning). Also the starting point for special event permits is our Permit Center. The HCD Permit Center offers the following services:

- Permit Assistance
- Resolve Code Violations
- Residential Escrow Reports
- Schedule Inspection
- Public Records Requests
- Special Events

COUNTY OF MONTEREY

Residents of Monterey County

BOARD OF SUPERVISORS

DISTRICT 1	DISTRICT 2	DISTRICT 3	DISTRICT 4	DISTRICT 5
Luis A. Alejo	Glenn Church	Chris Lopez	Wendy R. Askew	Mary Adams

COUNTY ELECTED OFFICIALS

ASSESSOR-COUNTY CLERK- RECORDER Marina Camacho
AUDITOR-CONTROLLER Rupa Shah, CPA
DISTRICT ATTORNEY Jeannine Pacioni
SHERIFF-CORONER Tina M. Nieto
TREASURER-TAX COLLECTOR Mary Zeeb

COUNTY ADMINISTRATIVE
OFFICE
Sonia M. De La Rosa, CAO

COUNTY COUNSEL
Les J. Girard

WATER RESOURCES AGENCY
Board of Directors

CIVIL RIGHTS OFFICE
Juan P. Rodriguez

WATER RESOURCES AGENCY
Ara Azhderian

PROBATION*
Todd Keating

NATIVIDAD MEDICAL CENTER
Board of Trustees

PUBLIC DEFENDER
Susan E. Chapman

NATIVIDAD MEDICAL CENTER
Dr. Charles Harris, CEO

AGRICULTURAL COMMISSIONER
Juan Hidalgo

CHILD SUPPORT SERVICES
Darrell McGowan

CLERK OF THE BOARD
Valerie Ralph

COOPERATIVE EXTENSION
David Gonzalvez

DEPARTMENT OF EMERGENCY
MANAGEMENT
Kelsey Scanlon

ELECTIONS
Gina Martinez

EMERGENCY COMMUNICATIONS
Lee Ann Magoski

HEALTH SERVICES-PUBLIC
ADMINISTRATOR
Elsa M. Jimenez

HOUSING AND COMMUNITY
DEVELOPMENT
Erik Lundquist

HUMAN RESOURCES
Irma Ramirez-Bough

INFORMATION TECHNOLOGY
Eric A. Chatham

LIBRARY
Hillary Theyer

MILITARY & VETERANS AFFAIRS
Jack Murphy (Interim)

PUBLIC WORKS, FACILITIES, AND
PARKS
Randy Ishii

SOCIAL SERVICES
Lori Medina

*appointed by Superior Court



This page intentionally left blank.

Executive Summary

County Administrative Officer's Message

Dear Members of the Board of Supervisors:

It is my pleasure to present the County of Monterey's *Fiscal Year (FY) 2023-24 Recommended Budget*, compiled in collaboration with departments, for your review, modification, and adoption. The FY 2023-24 Recommended Budget is balanced and maintains service levels, expands critical programs and services, and continues key infrastructure projects including those to improve the County's Park system and recreational service. The fiscally responsible budget allocates resources aligned with your Board's priorities and policies.

The Recommended Budget proposes a balanced \$1.9 billion spending plan, an increase of \$32.1 million (1.7%) over the current year adopted budget and supports a workforce of 5,841.3 positions. The budget anticipates fund balance use of \$37.9 million for one-time needs and to spend restricted funds on behavioral health services, road projects, and state-realigned public safety, health, and social services programs. Primary cost drivers include approved employee compensation increases, higher pension costs, and health insurance premiums.

Overall, the budget increases modestly in appropriation size, due to the elimination of one-time expenditures accommodated in the current year adopted budget for capital projects, including the Behavioral Health Clinic in East Salinas and transfers to designated funds. However, it is anticipated that the County will begin to experience significant cost pressures such as growing employee compensation and other rising inflationary costs that outpace growth in revenues, and many unfunded needs have been identified.

The Recommended Budget assumes a continued positive economy and overall revenue growth due to higher assessed values, improved state sales tax and realignment revenues, and renewed growth in tourism. Fund balance and American Rescue Plan Act (ARPA) funds are used for core government services including the administration of public safety, health, social service, public works, housing, and recreation programs countywide. In FY 2023-24, the last of ARPA funds will be allocated under revenue replacement; therefore, with dwindling resources new or expanded programs that commit future revenue must be deliberately planned.

The budget includes continued investments in key infrastructure projects to improve and replace wastewater and water systems throughout County's parks, County Service Areas, Sanitation Districts, and Laguna Seca. Broadband projects to expand connectivity to rural areas, remodel projects at the Natividad Medical Center, and contributions to support external agencies that share the County's strategic initiatives for economic development and public safety are also included in the budget.

With your Board's leadership and responsible financial oversight, the County will continue to align critical needs with available resources. Through your Board's stewardship, strategic reserves were bolstered, which provided critical funding to preliminarily address recovery from the disastrous weather in January and March 2023.

The compilation of this budget was a result of hard work, time and dedication by departments and the budget team. I would like to thank Department Heads for their collective cooperation through the budget process and all employees who continue to provide exceptional services to our community. I would like to thank the County Administrative Office's Budget Team and all department finance and budgetary staff. The following budget overview provides your Board and the public a summary of the County's spending plan for next fiscal year.

Sincerely,



Sonia M. De La Rosa

County Administrative Officer

Budget Overview

Current Financial Outlook

Over the last couple of fiscal years (FY 2021-22 and FY 2022-23), Monterey County (County) has experienced revenue growth of some discretionary revenue sources including sales tax, Transient Occupancy Tax (TOT), and property tax. During the same time, the County has been fortunate to have American Rescue Plan Act (ARPA) funds to continue providing government services to the community while responding the impacts from the pandemic and fund important water and sewer infrastructure projects. Even with these positive factors affecting available resources, many unmet needs remained in those fiscal years. A similar situation is presented as part this FY 2023-24 Recommended Budget (Recommended Budget). The County continues to experience growth in discretionary revenue and some ARPA revenue is still available to fund important services to the community. Unfortunately, many funding requests for service provision and capital needs are not recommended for funding due to lack of resources. This is a result of continued rising costs which continue to outpace revenue growth. In addition to these rising costs, the County will experience the phase out of ARPA revenue at the end of FY 2023-24.

The Recommended Budget includes the use of \$3.6 million in one-time funding for staffing costs to implement a new Enterprise Resource Planning (ERP) system. It also includes \$24.6 million in ARPA funding of which \$14.8 million represents one-time funds covering ongoing expenditures such as employee compensation and other ongoing operational expenses (more details about these costs will be covered in the augmentations section of this report). The use of this one-time ARPA funding allows the County to prevent reduction in services and any layoffs while providing funding for augmentations for critical programs in line with the Board's priorities. The Recommended Budget is a balanced budget; however, as discussed above, there are significant uses of one-time funds, and without new or increased revenues and / or cost reductions, the general fund will not be able to continue providing the same level of services in the future, particularly, once ARPA revenues are exhausted next fiscal year.

In addition to the current imbalance between ongoing revenues and ongoing needs, as the national and local economy continue to face inflationary cost pressures and with recent developments in interest rate increases, future economic impacts are unknown. The Recommended Budget is based on the continued positive economic assumptions experienced in the last years. However, if there is a negative change in the economy, which affects the County's revenue, County programs and services will be negatively impacted.

In order to mitigate potential economic impacts as the ones described, the County has strategically placed one-time surpluses into its strategic reserve (in accordance with financial policies), which ended FY 2021-22 with a balance of \$79.3 million for the general fund and \$25.0 million for Natividad Medical Center (NMC). In the current fiscal year (FY 2022-23), the County has faced several Atmospheric River events that caused flooding throughout the County. These natural disasters damaged infrastructure, displaced many residents and businesses, and negatively impacted the agricultural industry which is the most prominent economic force in the County, leaving large numbers of people out of work. Given the magnitude and impact of these disasters, the County has utilized \$31.0 million of the strategic reserve to provide advance funding to respond to these disasters and begin repairs of damaged infrastructure pending federal and state reimbursements. This leaves the strategic reserve with a current balance of \$48.4 million.

Recommended Budget – All Funds

The Recommended Budget for all departments and funds totals \$1.9 billion next fiscal year and includes 5,841.3 authorized positions. Significant changes since adoption of the FY 2022-23 budget include:

Appropriations increase \$32.1 million. Notable increases include \$33.1 million increase for Natividad Medical Center (NMC) to support growing labor costs and medical services; \$10.7 million increase in public safety realignment; \$9.0 million in behavioral health programs; \$8.5 million in health and welfare realignment; and \$8.7 million for Laguna Seca. Appropriations decrease by \$26.3 million for capital project funds as projects such as the Behavioral Health facility in East Salinas and projects for the Laguna Seca racetrack near completion. Other funds with lower appropriations include a \$6.4 million decrease in the resource planning ISF and \$4.7 million decrease in the general fund; both of these decreases are due to lower operating transfers as the current year includes one-time transfers to other funds.

All Funds	2021-22 Actual	2022-23 Adopted	2023-24 Recommended
Expenditures			
Salaries & Benefits	\$ 759.3	\$ 889.5	\$ 934.5
Services & Supplies	497.1	455.9	484.9
Other Charges	155.3	112.7	115.0
Fixed Assets	40.5	118.4	96.6
Op. Transfers Out / Other Financing	197.8	270.1	247.5
Contingencies	0.1	7.9	8.2
Total Expenditures	\$ 1,650.2	\$ 1,854.6	\$ 1,886.6
Revenues			
Taxes	\$ 282.5	\$ 271.1	\$ 298.1
Licenses, Permits & Franchises	24.9	23.1	27.9
Fines, Forfeitures & Penalties	12.6	13.8	13.0
State & Federal Aid	793.2	736.0	736.6
Charges for Current Services	438.1	443.3	480.5
Other Revenues	261.2	304.6	292.7
Total Revenues	\$ 1,812.5	\$ 1,792.0	\$ 1,848.7
Use of Fund Balance	\$ (162.3)	\$ 62.6	\$ 37.9
FTE Positions	5,516.6	5,737.2	5,841.3

*Numbers may not add up due to rounding.

Revenue increases \$56.7 million. Revenue increases \$42.9 million in the general fund primarily due to increased federal and State revenues related to social services programs, improvement in non-program revenue, and higher State realignment revenue for public safety and health programs. NMC’s revenue also increases by \$28.2 million primarily from health fees and increase in government funding. Other increases include \$9.9 million from state realignment funds that support public safety and health programs; \$9.2 million higher behavioral health revenues to support growing programs; and \$9.0 million increase in Laguna Seca revenue due to additional events as projects to improve the racetrack are projected to end, allowing for improved revenue projections. Funds with decreased revenue include capital project funds and the Road Fund with a \$22.6 million and \$18.0 decrease respectively due to completion of projects.

ARPA funds. The Recommended Budget includes \$24.6 million in ARPA funds (\$17.1 million general fund and \$7.5 million other funds). Of this total, the General Fund includes \$13.2 million in Revenue Loss funds used to fund to fund augmentations for core government services, and \$3.9 million for previously allocated ARPA funds rolling-over from the prior fiscal year to continue programs for economic recovery, broadband infrastructure, and health programs. Other funds include \$7.5 million in ARPA funds including a \$1.2 million augmentation for the Pajaro sanitation system and \$6.3 million for funds rolling-over to continue water and sewer infrastructure projects.

Rising labor costs. Next fiscal year, salary and benefit costs for the County’s workforce totals \$934.5 million, a \$45.0 million or 5.1% increase over the adopted budget. This increase results primarily from wage increases resulting from negotiated labor agreements. Most bargaining units will receive wage increases of 2.0% or 2.5% next fiscal year. Additionally, wage studies that were finalized for various classifications during the current year will also impact salaries. Wage studies that were completed when the Recommended Budget was being developed are included in the Recommended Budget. However, there are several wage studies which are under way and could create additional cost pressures to the County. The latest estimates indicate the impacts of these wage studies could impact the County’s FY 2023-24 budget by requiring additional resources of at least \$8.2 million if all the pending studies are completed in the next couple of months. In general, NMC and the general fund account for the largest salary and benefit cost increases as these funds have the greatest number of employees. Next fiscal year, the County adds 104.1 positions which also factors into the increase in employee compensation. Most of the added positions are at in the Health Department, in the Road Fund, and positions related to the ERP project and are supported with program revenue. Wages account for \$36.3 million of the increase. Other major cost drivers within the salary and benefits category include pension contributions and health insurance premiums increasing a combined \$13.9 million over the current year

adopted budget (all funds). Offsetting decreases include \$5.4 million lower temporary employees primarily in the Health Department due to scaling down temporary help needed for COVID related programs.

Recommended use of fund balance. The general fund uses fund balance to support department programs with restricted fund balance and to fund one-time expenses (\$10.8 million). Other funds utilizing fund balance include the Road fund (\$14.6 million) to start road projects funded by Measure X and SB 1, Behavioral Health (\$6.9 million) for expanded programs and one-time expenses, capital project funds (\$13.2 million), and realignment funds (\$13.7 million) to meet State-County Realignment commitments for public safety, health, and social services programs. NMC expects to improve their fund balance by adding \$13.5 million and the resource planning ISF adds \$3.9 million to its fund balance.

Infrastructure replacement. The Recommended Budget provides \$47.8 million in appropriations for capital projects such as continuing ARPA-funded sewer and water projects throughout the County’s park system, County Service Areas and County Sanitation Districts, and Laguna Seca; continued progress on the Carmel River and Carmel Lagoon floodplain projects; nursecall system at NMC as well as pharmacy and lab remodels; and Countywide end-of-life technology replacement. Other projects include repairs and/ or replacements throughout County buildings occupied by the Health Department, the Sheriff’s Office (including the jail), the Emergency Communications Department, and the Ag Commissioner.

Recommended Budget – General Fund

The general fund supports 3,573.7 authorized positions in 23 departments which encompass most County services and basic governmental functions including public safety and criminal justice, health, social services, land use, recreation, environment, administration, and finance. Following is an overview of the general fund budget:

General fund appropriations total \$847.0 million next fiscal year, a decrease of \$4.3 million over the current year adopted budget. The decrease is primarily driven by a technical change eliminating a \$30.7 million transfer out to the pension trust, which is in a separate fund and will collect funds directly in FY 2023-24 (without this technical change, appropriations would increase by 25.7 million). The general fund continues to experience major cost pressures including employee salaries and benefits, which increase \$13.0 million over the current year adopted budget. Higher wages and health insurance contributions resulting from approved labor agreements as well as position growth (64.5 positions added over adopted budget, some which were added in the current year), are all factors impacting salaries and benefits. Other cost increases include higher inmate health care costs and growth in social services programs due to higher caseloads and grant increases under CalWorks, more complex Out of Home Care cases, and wage increases for IHSS.

General Fund	2021-22 Actual	2022-23 Adopted	2023-24 Recommended
Expenditures			
Salaries & Benefits	\$ 446.5	\$ 536.6	\$ 549.5
Services & Supplies	202.5	189.2	198.7
Other Charges	47.6	54.1	52.6
Fixed Assets	5.0	7.8	13.1
Op. Transfers Out	38.9	55.7	24.8
Contingencies	0.1	7.9	8.2
Total Expenditures	\$ 740.6	\$ 851.3	\$ 847.0
Revenues			
Taxes	\$ 262.4	\$ 250.5	\$ 275.1
Licenses, Permits & Franchises	24.7	22.9	25.8
Fines, Forfeitures & Penalties	11.6	11.2	10.6
State & Federal Aid	277.6	294.7	307.9
Charges for Current Services	67.8	77.2	76.0
Other Revenues	110.8	136.8	140.8
Total Revenues	\$ 755.0	\$ 793.4	\$ 836.2
Use of Fund Balance	\$ (14.4)	\$ 57.9	\$ 10.8
FTE Positions	3,367.7	3,509.2	3,573.7

*Numbers may not add up due to rounding.

Revenue increases \$42.9 million over the current year adopted budget. Program revenue grows \$24.2 million and is driven by expanded programs in social services such as CalWorks and Out of Home Care, and public safety programs in the Probation and Sheriff’s Department, funded by grants, state reimbursements, public safety sales tax, and realignment funds. Discretionary revenue is projected to increase by \$18.6 million. The two major discretionary revenue sources are property tax and transient occupancy tax (TOT), which are

projected to improve from the prior year adopted budget by \$13.2 million and \$12.2 million, respectively. However, the increase is partially offset with \$2.8 million reduction in cannabis revenue from the adopted budget, and \$6.8 million lower ARPA funds. Further reductions in cannabis revenue are likely but are not part of the Recommended Budget due to timing of changes affecting this revenue occurring after this Recommended Budget was produced.

Fund balance use of \$10.8 million supports department programs and one-time funding needs. Departmental restricted fund balance is utilized by the Health Department (\$5.5 million) to cover a liability payment to the State related to the true-up of payments received and services rendered in health clinics, to purchase a mobile / rolling clinic, and for environmental health oversight. Departments use \$2.8 million in departmental restricted fund balance for appropriate expenses in Social Services, the District Attorney, the Sheriff, and the Public Defender. The Information Technology assignment (\$1.5 million) funds projects to replace technology infrastructure. Other assignment uses include the disaster recovery assignment for winter storm projects in the Road Fund, the general capital assignment for equipment to enhance Elections security, and cannabis assignment for rain response expenses in the Emergency Operations Center, rolling over from the current year.

American Rescue Plan Act (ARPA) funds of \$17.1 million to backfill revenue loss and fund economic recovery and broadband projects. The County is utilizing \$13.2 million in the general fund in qualified revenue loss for provision of government services across multiple departments. Other programs funded under ARPA include \$1.6 million for economic recovery through programs with the Monterey Convention Visitors Bureau and the Monterey County Business Council; \$1.9 million in funds rolled over from the current year for broadband infrastructure projects; and \$483,149 rolled over from the current year for Health programs.

Provides funding to the road fund to support road maintenance. \$6.2 million is contributed to the Road Fund to meet the voter approved Measure X maintenance of effort requirement.

Includes TOT funding for external agencies that support public safety and promote tourism, arts, and economic development. The Recommended Budget includes contributions to Development Set Aside (DSA) Agencies, fire agencies, and 911 user agencies in accordance with the current financial policy. Contributions to the DSA's and the Monterey County Business Council total \$2.1 million next fiscal year and are capped at the FY 2019-20 level based on approved Board policy. In addition to the share of TOT funding, the County also provided \$4.0 million in ARPA funds to be used over multiple years. The original allocation provided \$1.5 million to the Monterey County Convention and Visitors Bureau (MCCVB) and \$2.5 million to the Business Council in support of multi-year agreements for tourism and hospitality recovery programs and economic development assistance to small businesses. The Recommended Budget includes \$1.6 million of the original \$4 million allocated to these agencies. Discretionary contributions of Proposition 172 funds (Public Safety Sales Tax) to the fire agencies and 9-1-1 dispatch center user agencies total \$4.0 million and \$2.2, million respectively.

Fiscal Pressures Shaping the General Fund Budget

The following section outlines major cost drivers that are affecting the budget:

Employee compensation and growing workforce.

Salaries and benefits of \$549.5 million grow by \$13.0 million over the current year adopted budget; however, growth was actually higher. The increase would be about \$18.3 million, if we exclude an offsetting decrease of \$5.3 million in the Health Department due to a reduction of its temporary employees as COVID response programs wind down. The increase is reflective of wage increases resulting from labor agreements and wage studies in the current fiscal year, rise in pension contributions, and health insurance. Departments included an overall salary and benefit savings of \$17.9 million in the adopted budget and \$26.3 million in the Recommended Budget due to ongoing vacancies and recruitment challenges, primarily in larger departments such as Health, Social Services, and Sheriff’s Office.



The increase is reflective of wage increases resulting from labor agreements and wage studies in the current fiscal year, rise in pension contributions, and health insurance. Departments included an overall salary and benefit savings of \$17.9 million in the adopted budget and \$26.3 million in the Recommended Budget due to ongoing vacancies and recruitment challenges, primarily in larger departments such as Health, Social Services, and Sheriff’s Office.

In July 2021 and October 2021, the Board of Supervisors approved wage increases for FY 2021-22 through FY 2023-24 consisting of 6% over the three years for most labor groups and 7% for SEIU. FY 2023-24 is the final year under the agreements with 2.0% wage increases for most labor groups and 2.5% increase for SEIU. Additionally, the County continues to undertake wage studies for various classifications typically resulting in higher compensation. Next fiscal year, wages increase \$11.5 million over the current year adopted budget, or 3.75%. Again, the increase is not only impacted by higher approved wages, but position growth, wage adjustments, and step advances.

The impact of wages and benefits continues to magnify over the years, as prior year wage increases, rising pension costs, and health insurance premium increases accumulate. Additionally, over time the County has added staff to its workforce which also contributes to the growth in salaries and benefits. Employee salaries and benefits are the County’s largest cost, representing 64.9% of the general fund budget. The cost has grown from \$365.2 million in FY 2014-15 to \$549.5 million in FY 2023-24, an increase of \$184.3 million over the last nine fiscal years. Over the same period, authorized positions increased by 306 in the general fund. Also, as mentioned in a previous section of this report, the County will see significant impacts to its salary costs as more wage analyses are completed. It is currently estimated the minimum potential costs for these analyses to be \$8.2 million. In addition to these wage analyses, there are also pending class studies and potential creation of new classifications which could result in additional costs of about half a million.

Reason	FTE	Potential Impact
Class Study	11.00	82,475
New Classification	3.00	501,623
Wage Analysis	1,344.50	8,214,309
Grand Total	1,358.50	8,798,407

Pension contributions continue to increase. Contributions to the CalPERS pension fund have increased significantly since FY 2017-18 due to changes in CalPERS’ actuarial methodology and funding policies. Significant changes include lowering the discount rate to reflect CalPERS’ expected return on investments, updating demographic assumptions that show retirees live longer and require higher lifetime payout of benefits, and accelerating payment of unfunded liabilities by changing amortization policies. Part of the pension contributions go toward paying down unfunded liabilities; since FY 2017-18, this portion of the payment is fixed and not based on payroll, protecting the pension fund in situations where employers have declining payroll.

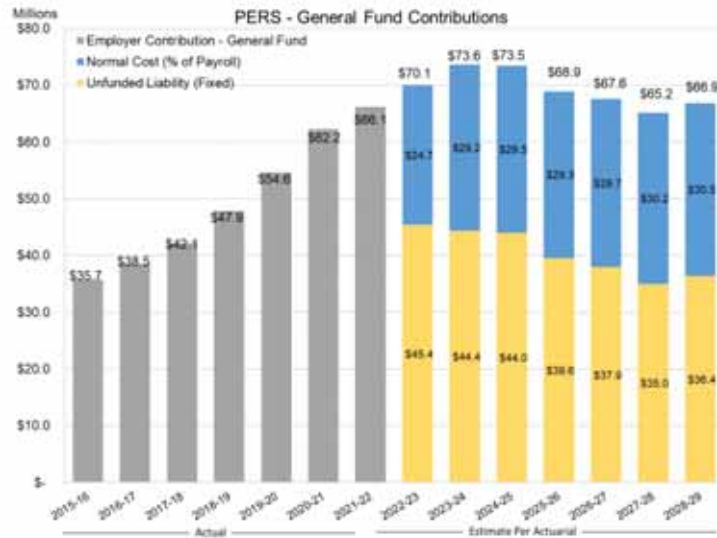

The projections in the chart are based on CalPERS actuarial valuations, which are built on actual payroll data obtained by CalPERS, therefore, based on existing staffing levels and does not account for new positions. These estimates are based on current pension plans and assumptions and assume no gains or losses to the current portfolio. Changes in any of the preceding matters will impact required contributions. The chart above reflects the projected fixed contributions (general fund) going toward unfunded liabilities, which are about 65% of the total contributions. The Recommended Budget includes funding for required employer contributions for normal cost and unfunded liability. An estimated \$44.4 million in the General Fund and \$64.7 million including all funds goes toward paying down the County’s unfunded pension liability.

Pension cost does not only impact the County but employees also. Over the years, because of ongoing fiscal pressures and pension reform, employees also contribute to the CalPERS pension fund. In the upcoming fiscal year (FY 2023-24), based on actuarial information, employees contribute an estimated \$34.8 million for all funds into the miscellaneous and safety pension plans.

Unfunded pension liabilities. Despite rising employee and employer contributions toward pension, the unfunded liability remains significant at \$568.3 million for both the Safety and Miscellaneous plans as of the latest valuation report. This liability has improved due to strong investment returns realized through June 2021. However, the investment returns experienced are not ordinary and the returns have receded which will impact unfunded liability in the next actuarial valuation. The Board of Supervisors adopted a pension liability policy, and the County established an IRS Section 115 pension trust. The trust serves as an investment vehicle outside of the County’s Treasury Pool to generate investment proceeds to address future pension liability obligations. The County has implemented supplemental pension contribution charge to departments to continue setting aside funds for pension liability allowing for continuous investments as opposed to only contributing surpluses or one-time funds. The Recommended Budget includes \$11.0 million in the general fund (\$15.2 million all funds) for this supplemental pension charge. Some departments recover a portion of these costs from non-County funding sources to share in the growing UAL costs created in prior years.

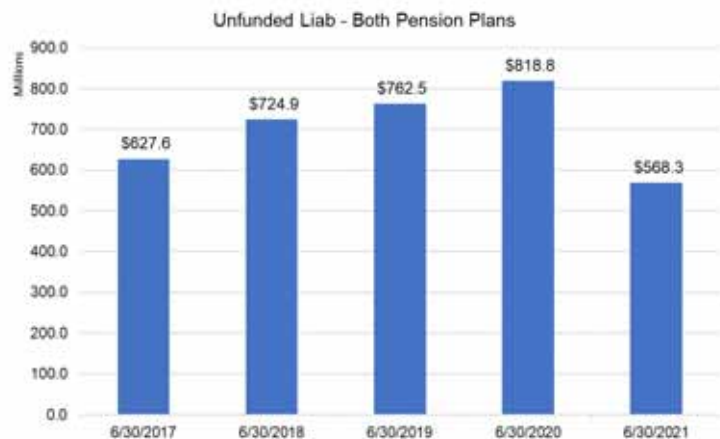

The benefit of this strategy is to reduce future employer cash flow requirements for pension cost, which can be beneficial during hard economic times, and can mitigate reductions of critical programs. This investment reduces the reliance on discretionary and program revenues to meet this obligation and prepares the County to address unfunded liabilities in the future.

Health insurance premiums continue to rise.

The current year adopted budget includes \$16.3 million higher costs from the prior year. Next fiscal year, the Recommended Budget includes \$77.9 million for health insurance costs, an increase of \$2.7 million from the FY 2022-23 adopted budget. Recent increases beginning with FY 2022-23, are a direct result of the terms of the latest negotiated labor contracts which include higher County contributions for premiums and higher costs of flex cash credits provided to more bargaining groups. Another factor impacting the increase is position growth over the years. Historically, increases in premiums have been absorbed by the County, making it a significant cost pressure every year.

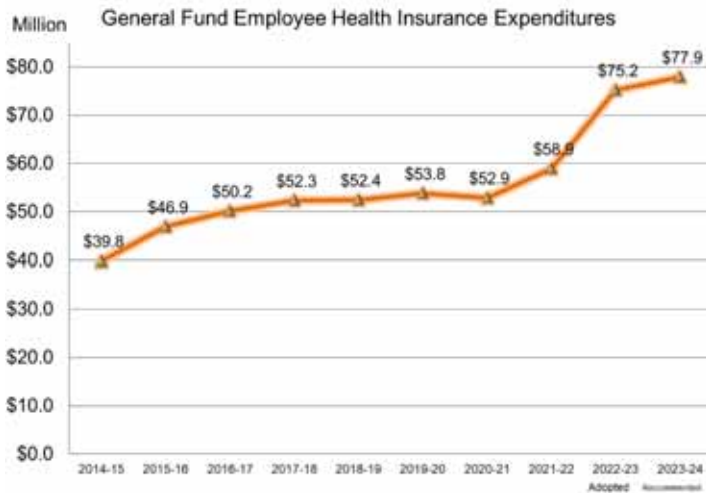

It should be noted that the County typically has salary and benefit savings due to vacancies. The budget figures on the chart do not reflect savings, although salary savings / vacancy assumptions are factored into the overall salary and benefit figures in the adopted and recommended budgets to account for the reality of lower filled positions.

Workers' compensation and general liability program costs.

Although the costs for these programs are not increasing next fiscal year, they are \$13.8 million higher than in FY 2014-15. Both programs are forecasted to increase 10-15% in the following two years. Additionally, the programs may be impacted due to changes in actual claims as compared to the actuarial and also impacted by investment return on assets.

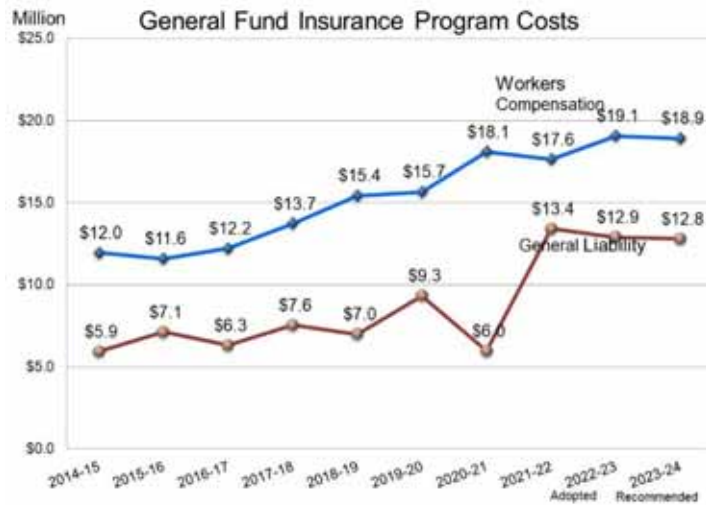

The chart reflects the historical trend for workers' compensation and general liability costs. The decrease in FY 2020-21 for general liability costs, is reflective of the suspension of approximately \$8.5 million in charges of GL non-recoverable costs to general fund departments due to budgetary constraints. That was a one-time funding solution, and in FY 2021-22, the costs resumed. Both workers' compensation and the general liability insurance programs are based on a 70% funding confidence level.

General Fund Revenue

Overall, general fund revenue increases next fiscal year by \$42.9 million driven by improvement in non-program revenue, State and federal aid for social services programs due to increased caseload and grant increases in CalWorks and higher costs for IHSS and Out of Home Care, and an increase in state realignment funding coming into the general fund for public safety, health and social services programs. The general fund revenue is composed of about two-thirds of program revenue generated by departments for their specific programs, and about one-third discretionary revenue.

Discretionary revenue increases \$18.6 million from the adopted budget. Property tax is expected to increase \$13.2 million based on assessment data and projections from the Assessor. Although property taxes have remained strong in the last few years, transactional real estate data is revealing a cooling off in the real estate market, which affects other revenues such as recording fees. This decrease in recording fees can be an early indicator that property tax revenue growth will slow or level out.

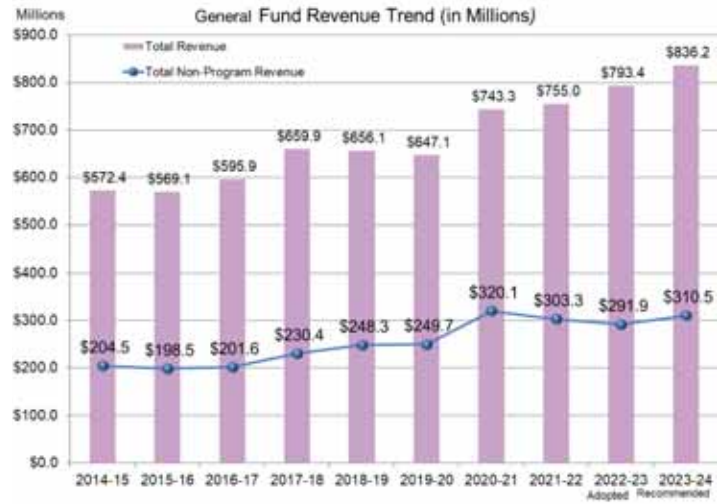

Revenue	2021-22 Actual	2022-23 Adopted	2023-24 Recommended	Change from Rec. to Adopt.
Property Tax	197,655,843	202,992,531	215,264,907	12,272,376
Transient Occupancy Tax	40,025,756	27,823,878	40,025,756	12,201,878
Cannabis Tax	9,115,604	7,396,341	4,587,611	(2,808,730)
Vehicle License Fees	423,070	177,745	270,725	92,980
Sales & Use Tax	15,605,949	12,276,400	15,270,555	2,994,155
Franchise Fees	7,766,352	5,715,477	6,260,703	545,226
Tobacco Settlement	4,720,882	4,316,018	4,470,336	154,318
Federal Aid	17,933,637	23,910,411	17,104,515	(6,805,896)
Other	10,039,493	7,319,736	7,286,672	(33,064)
Total	303,286,586	291,928,537	310,541,780	18,613,243

Transient Occupancy Tax (TOT) is \$12.2 million higher than the adopted budget; however, the estimate is in line with prior year actuals. The current year adopted budget was developed before full year data was available and TOT has remained strong through the current year, supporting the estimate for next fiscal year. Next fiscal year assumes no negative developments or added restrictions related to COVID and current economic conditions do not deteriorate. It is important to note that TOT is highly sensitive to the economy and a recession will rapidly impact this revenue source.

Other significant changes in discretionary revenue include improvement in sales tax of \$3.0 million and slightly higher franchise fees. Cannabis revenue declines by \$2.8 million from the current year adopted budget due to lower tax rates and ARPA funds decrease by \$6.8 million from the adopted budget.

Cannabis Revenue and Assignment

Previously cannabis revenues were utilized for the cannabis regulation program only with excesses reserved in assignment for Board directed purposes. Beginning FY 2020-21, the Board approved all ongoing cannabis revenue as discretionary revenue providing departments funds to continue programs that were at risk due to insufficient funding.

During FY 2021-22, the Board approved reductions to cannabis tax rates, resulting in a decrease of \$9.1 million from the \$18.8 million budget. The FY 2022-23 adopted budget includes \$7.4 million, however, due to further reductions approved by the Board, estimated revenues are \$4.6 million, which represents the operational cost of the cannabis program. This also the amount included for next fiscal year. Further reductions or payment arrangements may impact the actual revenue received and create an imbalance in the budget requiring modifications. This approach is consistent with Board direction provided during the budget workshop. However, further reductions to the budget may be necessary pending actions to be taken by the Board after the production of the Recommended Budget.

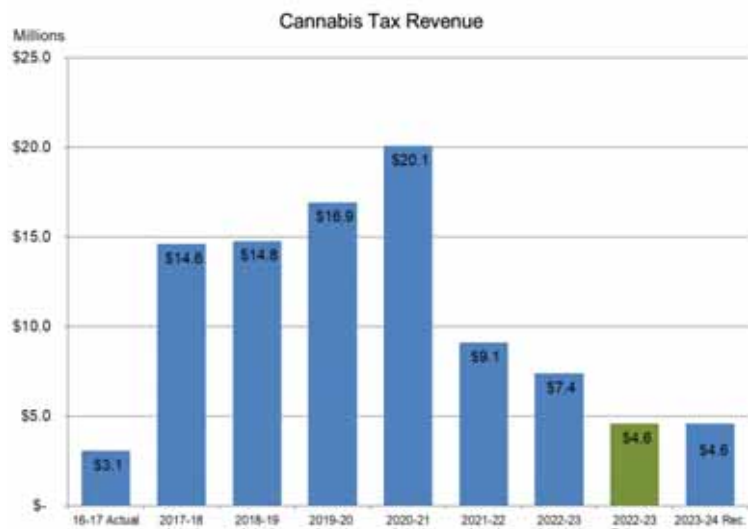

The cannabis assignment had a balance of \$14.3 million at the end of last fiscal year. Current year use of the assignment as authorized by the Board totals \$14.5 million. Uses include \$6.6 million to fund various programs and positions in the FY 2022-23 adopted budget, \$2.7 million for the Laguna Seca start-finish bridge, \$1.3 million for the Pajaro CSD shortfall, \$1.0 million for the jail addition, \$1.2 million as a loan to cover storm related response, and other programs approved during the year. The cannabis assignment has been depleted this current year, and no additions are anticipated given the cannabis tax reductions.

Pandemic related Federal Aid - ARPA

The County received an allocation of \$84.3 million from the American Rescue Plan Act (ARPA). Funds could be spent over multiple years but no later than December 31, 2024. Given its magnitude, ARPA funds have been instrumental in carrying the County’s core operations and expanding programs related to pandemic response, economic recovery, and infrastructure investments. The Recommended Budget includes \$17.1 million of these funds in the general fund and an additional \$7.5 million in other funds to support solid waste and water system projects throughout the County’s Park system, Laguna Seca, and sanitation districts. Most of the infrastructure funds are roll-over funds from previously approved projects. Staff initially prepared a plan for utilizing the funds by category and by year, which the Board approved. This Recommended Budget includes an updated plan incorporating changes including but not limited to changes in allocation to re-allocate amounts not spent in prior years and updates to Board priorities. See Attachment A for further details on ARPA amounts previously spent, current year allocations, and future allocations.

Baseline Budgets and Requested Augmentations

In February, staff presented the Financial Forecast, which estimated a surplus of \$4.4 million for FY 2023-24; largely due to a projected surplus of \$26.8 million in the current year. Since the Forecast was presented, many factors have arisen that may impact the financial picture at the end of the current year. Most significantly, winter storms and floods that affected the County required significant resources to bridge disaster related aid from the federal government. As a result, the County has used \$31.0 million from the Strategic Reserve. Additionally, several classification and compensation studies have been finalized since the presentation of the Forecast, which did not include related impacts due to timing.

In March, departments submitted initial “baseline budgets” which communicate what level of operations can be afforded with preliminary General Fund Contributions (GFC). General fund departments start out with a base level GFC which was adjusted for variances in workers compensation and general liability payments,

cost-plan charges so that it remained budget neutral, and for the supplemental pension charge. Additionally, all discretionary revenue growth was allocated to departments to utilize in baseline budgets.

At the April 4 budget workshop, the Board was presented with a status of the baseline budgets and requested augmentations and they provided direction to staff. The baseline budgets include \$4.6 million in cannabis revenue, which is the cost to operate the program. There is no change in the Recommended Budget for cannabis, and this revenue estimate will be subject to revision based on Board action on this matter.

Augmentation requests totaled \$123.5 million in expenditures, with corresponding \$9.8 million in revenue for a net request of \$113.7 million for all funds, of which \$82.6 million are capital projects. General fund requests totaled \$30.3 million.

Category	FTE	Expenditures	Revenues	Net Request
Capital Improvements	-	82,566,096		82,566,096
Contribution to Other Funds	-	1,944,652		1,944,652
ERP Replacement Project Backfill	19.00	3,607,728	3,607,728	-
New Mandated Program/Service w/ General Fund Funding	-	858,306		858,306
New Mandated Program/Service w/ Outside Funding	2.00	276,385	276,385	-
New Program/Service w/ General Fund Funding	-	4,894,604	304,250	4,590,354
New Program/Service w/ Outside Funding	-	1,800,000	550,000	1,250,000
Request New Position	77.00	9,475,768	4,624,895	4,850,873
Status Quo Filled Position	2.25	448,823		448,823
Status Quo Other	-	15,838,100		15,838,100
Status Quo Vacant Position	13.00	1,782,182	437,733	1,344,449
Grand Total	113.25	123,492,644	9,800,991	113,691,653

Position impacts \$1.8 million. Position related impacts for baseline budgets included \$448,823 for 2.25 filled positions including a management analyst in Social Services, a public defender attorney, and a partial FTE secretary in the Co-operative Extension. Vacant positions at a cost of \$1.3 million included 8.0 positions in the Assessor-Clerk-Recorder, 3.0 dispatchers in Emergency Communications, an HR Program Manager, and a veterans' representative in Social Services.

Other status-quo needs \$15.8 million. Departments requested other status-quo needs to continue current service levels. Examples of some requests include contracts under the CAO for climate action plan, legislative advocacy contracts, communications operating budget, violence prevention initiative update; upgrades for countywide software; custodial service; fire fuel abatement; unscheduled maintenance for County facilities; utilities for shared facilities; inmate medical contract; and IHSS wage increase.

New positions \$4.9 million. Departments requested 98 new positions; including 17 positions in the behavioral health fund, funded with program revenue. General fund Departments requested 81 new positions, including 24 positions in Health funded with program revenue; 19 positions for the ERP project funded by ERP funds; six positions in Social Services funded with realignment funds; and two positions in Probation funded with program revenue. Departments requesting new positions funded by discretionary revenue included Auditor-Controller (4 positions); CAO (3 positions); District Attorney (1 position); HCD (6 positions); Human Resources (1 position); Public Works (8 positions); and Sheriff-Coroner (7 positions).

Contributions to other funds \$1.9 million. Requests included a contribution of \$1.2 million for the Pajaro sanitation system, \$629,000 for Vehicle Replacement Program for patrol vehicles, and \$115,489 for the County portion to restore dispatchers in the Emergency Communications Department (the department leverages County funds).

New Programs \$6.7 million. Requests include general plan housing update, housing program, short term rental ordinance, homeless encampment mitigation program, grant program under Department of Emergency Management, Emergency Operations Center assessment, digital file conversion for the District Attorney, First 5 outreach programs supporting career development for early educators and childcare, cannabis education program, programming and equipment for the employee wellness program, equipment and services for illegal

dumping program, spay/neuter program, and many other requests with detail provided in department narratives and as attachments to this Summary.

Capital Projects \$82.6 million. Public Works Facilities and Parks Department submitted requests for capital projects throughout the county including improvements to County-owned buildings, improvements and repairs to Lake Nacimiento and Lake San Antonio, and repairs at several CSD's and CSA's.

Recommended Augmentations

During the April budget workshop, the Board gave general policy direction to staff which is represented in the Recommended Budget to the extent of resources availability. As in prior years, all discretionary revenue was allocated to departments in the baseline budget, thus discretionary revenue was not available for augmentations. Staff identified funding sources primarily consisting of \$14.3 million in remaining ARPA Revenue Loss, fully allocating ARPA funds, and appropriate use of reserves to fund augmentations. The funding sources for recommended augmentations include:

- **ARPA funds.** Staff identified \$14.3 million in ARPA Revenue Loss for augmentations (\$13.2 million in the general fund) for provision of government services, funding 11.25 positions, including four new positions, and other expenditures for status quo and new programs. While ARPA is considered one-time revenue, it is funding ongoing expenses. When ARPA funds are no longer available, these programs will be dependent on discretionary revenues. If revenue growth is not sufficient to cover these commitments in future years, reductions will be necessary.
- **Utilization of one-time funds.** The ITD assignment (\$1.5 million) is funding equipment replacement for end-of-life network and data center system. The building improvement and replacement funds \$950,000 in unscheduled maintenance to County facilities. The capital assignment (\$250,000) funds equipment to enhance security at election polling places.
- **Departmental funding.** Departments such as Health, Social Services, and Probation are able to leverage state and federal funds for new positions and programs.
- **ERP Funds.** Augmentations were approved within the Auditor-Controller, Human Resources, and CAO for positions related to the implementation of the ERP project, which will be funded by funds earmarked for the ERP replacement.

General Fund Augmentations - In reviewing requests for augmentation, staff prioritized recommendations based on feedback received at the budget workshop. Staff prioritized augmentation requests that could qualify under ARPA funds, leverage sustainable revenue from other agencies, and meet critical infrastructure needs. In total, staff recommend \$14.9 million (net of offsetting revenues) in augmentations in the general fund. Due to limited ARPA funds, augmentations were modified to a lower amount, where appropriate, such as vacant positions or new programs anticipating typical delays to hire or implement expanded service.

Department	FTE	Expenditures	Revenues	Net Request	Rec. Amount
Assessor-County Clerk-Recorder	4	594,719		594,719	545,159
Auditor-Controller	12	2,244,917	2,244,917	-	
Civil Rights Office	0	38,294		38,294	38,294
Cooperative Extension Service	0.25	40,118		40,118	40,118
County Administrative Office	4	1,680,158	548,760	1,131,398	1,067,864
Department of Emergency Management	0	95,000		95,000	95,000
District Attorney	1	120,390		120,390	100,325
Elections	0	1,812,858		1,812,858	1,710,659
Health	24	4,400,037	3,650,888	749,149	749,149
Housing and Community Development	0	320,906		320,906	320,906
Human Resources	4	864,051	814,051	50,000	50,000
Information Technology	0	2,200,000		2,200,000	2,200,000
Probation	2	412,567	276,385	136,182	136,182
Public Defender	1	292,970		292,970	292,970
Public Works, Facilities & Parks	2	2,753,066		2,753,066	2,473,102
Sheriff-Coroner	0	3,380,255		3,380,255	3,380,255
Social Services	8	2,624,400	968,712	1,655,688	1,633,370
Treasurer-Tax Collector	0	38,203		38,203	38,203
Grand Total	62.25	23,912,909	8,503,713	15,409,196	14,871,556

Recommended augmentations funded 2.25 filled and 5.0 vacant positions at risk due to cost pressures. Augmentations also approved 51 new positions, of which 32 were funded entirely with departmental revenue in Health, Social Services and Probation and 19 positions with ERP funds in Auditor-Controller, Human Resources, and CAO. Four new positions were added utilizing ARPA funds in CAO, District Attorney, and Public Works. Other augmentations for capital improvements, new programs, and other operational costs were also recommended and further discussed below. Recommended augmentations include:

- \$3.4 million to the Sheriff to cover the increase to inmate medical care contract, which expands mental health services.
- \$2.5 million for Public Works, Facilities & Parks to fund unscheduled maintenance throughout the County buildings; utilities for shared facilities, inspections for parks playgrounds, funds to closeout a well at the Laurel fueling facility, and fire fuel abatement program. Two new parks building and grounds worker supervisors were also approved.
- \$2.2 million to the Information Technology Department for software licenses and hosting for the ERP system.
- \$1.7 million to the Elections Department to cover increased operational expenses such as printing, mailing, and higher temporary labor related to the Presidential Primary Election scheduled next fiscal year. This includes \$250,000 from the capital assignment for equipment such as cameras for polling places.
- \$1.6 million to Social Services for increased wage and health benefits for IHSS care providers, for homeless outreach, and to restore a filled management analyst and a vacant veteran's representative. Additionally, six new positions funded with realignment revenue were added including two departmental information system coordinators, a management analyst, a program manager in Family & Children Services, a community affiliations manager for the Area Agency on Aging, and an accounting technician.
- \$1.1 million to the County Administrative Office including a new management analyst for the homeless program under IGLA, funds to restore legislative contracts, an economic development contract, media communications operational expense, homelessness services and supplies, memberships, funds for a climate action plan under the sustainability program, materials for the Contracts Purchasing Academy, and funding to manage Café and Daycare locations / leases.
- \$749,149 to Health including \$483,149 of previously allocated ARPA revenues to continue the crime prevention program, and the remaining \$266,000 is for contracted services under the SART program. The Department also added 41 new positions (24 in the general fund), all funded by program revenue mostly

to support growth in clinic services and behavioral health. Additionally, augmentations for participatory budgeting and hygienic program were funded with department revenue.

- \$545,159 to restore four vacant positions at the Assessor’s including two appraisers, an auditor-appraiser, and a supervising appraiser.
- \$320,906 to the Housing and Community Development Department for the general plan update and the Chualar Community Plan.
- \$292,970 to the Public Defender to restore a filled attorney position.
- \$136,182 to Probation for building maintenance at the new Juvenile Hall. The Department also adds a new probation officer and probation aide funded by program revenue for a State realigned program for juveniles.
- \$361,940 to six departments including a new departmental information systems coordinator in the District Attorney, funding to the Department of Emergency Management for winter storm action report and software upgrade, operational expenses for Civil Rights, funding to Co-operative Extension to restore a partial FTE and services and supplies, legal services for labor negotiations in Human Resources, and funding to the Treasurer-Tax Collector to offset increasing costs for cannabis tax collection.
- 19 new positions were approved as ERP backfills including 12 positions in the Auditor-Controller, 3 positions in CAO, and 4 positions in Human Resources. The cost of these positions total \$3.6 million and are funded by ERP funds.

Remaining Unfunded Needs

Remaining unfunded requests are described below, and Attachment B includes further detail. The general fund has \$14.4 million in unfunded requests, while other funds have \$80.1 million in unfunded needs representing capital projects.

Row Labels	FTE	Expenditures	Revenues	Net Request
001	31	14,477,774	96,000	14,381,774
Capital Improvements	0	974,975		974,975
Contribution to Other Funds	0	629,000		629,000
New Mandated Program/Service w/ General Fund Funding	0	368,650		368,650
New Program/Service w/ General Fund Funding	0	3,792,701	96,000	3,696,701
New Program/Service w/ Outside Funding	0	700,000		700,000
Request New Position	26	3,858,622		3,858,622
Status Quo Other	0	3,538,002		3,538,002
Status Quo Vacant Position	5	615,824		615,824
021	0	40,000		40,000
Contribution to Other Funds	0	40,000		40,000
404	0	80,103,121		80,103,121
Capital Improvements	0	80,103,121		80,103,121
Grand Total	31	94,620,895	96,000	94,524,895

Vacant positions. A total of 4.0 positions in the Assessor / Clerk-Recorder are being deleted, including an assessment clerk, a map drafting technician, a property transfer clerk, and an office assistant. A vacant program manager is also being deleted in Human Resources.

New position requests. A total of 26 new positions were not recommended including: seven positions in the Sheriff’s Office (\$1,226,019) including two accounting positions, a departmental information technology coordinator, a commander and a sergeant for the jail, and two positions for records management; six positions in Public Works, Facilities, and Parks (\$735,910) including three positions for North County and Jacks Peak park, two positions for Lake San Antonio, and a facilities real property specialist; six positions in the Housing and Community Development Department (\$898,396) including two planners, a business technology analyst, a code compliance inspector, a GIS analyst, and a permit technician; four positions in the Auditor-Controller’s Office (\$548,225) including two internal auditor positions, an accountant auditor, and an accounting technician. Other requests include two new positions in CAO and one in Human Resources.

Animal shelter and services. Requests for Animal Services (\$1.0 million) remain unfunded including the animal shelter feasibility study and mobile spay / neuter clinics.

First 5 and Bright Beginnings. Programs including Bright Beginning initiatives for outreach and advocacy (\$225,000), investment in the Informal Child Caregiver Network (\$300,000), and implementation of a career pathway program for early educators (\$350,000) are not included in the Recommended Budget.

Digital conversion. The District Attorney's request for digital file conversion (\$1.3 million) is not included in the Recommended Budget.

Sheriff vehicle requests and additional funding for deputies. The Sheriff's request to fund unfunded deputies (\$949,129) and vehicle related requests (\$1.5 million) including upfitting patrol cars, providing Vehicle Replacement funds for 35 patrol cars, and adding a cannabis vehicle, are not included.

Unfunded Capital Projects. Capital improvement requests of \$80.1 million are not included as they are unfunded. Requests include improvements to the various County owned facilities such as health clinics, the jail, juvenile hall, libraries, the Lakes, etc. A listing of the requests is provided in Attachment B.

Other unfunded needs. \$2.0 million in requests from Public Works Facilities and Parks for custodial service and security at County facilities, parking citation management, and COVID-19 related expenses were not included in the Recommended Budget. Other requests that were not funded include homeless encampment mitigation program (\$100,000); requests from the Department of Emergency Management (\$315,000) for a vehicle, EOC assessment, grant writing; requests by Health for the illegal dumping pilot program (\$128,000), cannabis education program (\$225,000); and general assistance request in Social Services (\$102,120). Many more unfunded needs remain, and detail by department can be found in Attachment B.

Next Steps

The Recommended Budget will be presented at the Budget Hearings commencing on May 31st, where staff will present an overview of the spending plan and the Board will hear presentations from Department Heads and receive input from individuals and organizations within the community. During the hearing, the Board may make additions, reductions or modifications to the recommended spending plan. Financing sources for potential modifications are discussed below.

- **ARPA Funds.** Staff is presenting an updated plan to utilize ARPA funds for eligible expenditures under various categories within ARPA. The Board may direct staff to modify the spending plan.
- **Contingencies appropriation.** In accordance with Board policy, the budget includes 1% of estimated general fund revenues (\$7.9 million for FY 2023-24) set aside for operational contingencies that arise next year. Contingencies is considered one-time funding; therefore, to the extent these funds are utilized to fund ongoing operations, funding gaps will emerge in the subsequent budget cycle.
- **Redirection of resources.** The Board can direct staff to delete or modify County programs or contributions to other agencies that are funded in the Recommended Budget and redirect those resources to fund other requests.

Additionally, the Recommended Budget includes \$4.6 million in cannabis revenue, which may change should the Board take action to further lower cannabis tax or grant payment plans. Should this revenue decrease, another funding source will have to be identified to continue funding the cannabis program. Otherwise, reductions to the program, or a combination of another funding source and modification of cannabis program will be necessary.

Other Funds

This section summarizes the Recommended Budget and anticipated fund balance for other major funds. Fund balance information for FY 2021-22 is based on the Annual Comprehensive Financial Report (ACFR), which contains a negative adjustment required, per GASB, to report change in fair market value of investment. This

does not impact the book value or cash balance, which is reported correctly in the financial system. The fund balance without the adjustment will remain in the financial system, however, at the time of this writing, the financial system data has not been finalized for FY 21-22, and thus the ACFR is used for fund balance information.

Natividad Medical Center

The Recommended Budget for the Natividad Medical Center (NMC) enterprise fund totals \$399.3 million in expenditures, financed by \$412.9 million in revenue, resulting in a \$13.5 million increase in fund balance.

Personnel costs and medical operating costs are the largest cost drivers in the budget. Personnel costs are budgeted at \$270.8 million, an increase of \$23.6 million from the FY 2022-23 Adopted Budget. The increase includes an additional 6.1

Natividad Medical Center	Actuals 2021-22	Adopted Budget 2022-23	Current Year Estimate 2022-23	Recommend 2023-24
A. Beginning Fund Balance	\$ 197,645,976	\$ 259,367,038	\$259,367,038	\$ 281,233,642
B. Revenue	418,019,985	384,650,960	404,393,676	412,886,422
C. Use of Fund Balance	-	-	-	-
D. Total Financing, A+B+C	615,665,961	644,017,998	663,760,714	694,120,064
E. Expenditures	356,298,923	366,221,605	382,527,072	399,347,035
F. Assignments to Fund Balance	-	-	-	-
G. Total Financing Uses, E+F	356,298,923	366,221,605	382,527,072	694,120,064
H. Ending Fund Balance, D-G	\$ 259,367,038	\$ 277,796,393	\$281,233,642	\$ 294,773,029

full-time equivalent (FTE) positions where the growth is primarily in nursing and volume-driven departments such as Medical/Surgical and Emergency. Employee step advances, higher employee benefit costs, and pay raises also contribute to the increase in personnel costs. Service and supplies are budgeted at \$99.8 million, an increase of \$10.6 million over the FY 2022-23 Adopted Budget. The increase is largely made up of an anticipated increases in medical supplies and professional services usage.

The \$28.2 million increase in revenue over the FY 2022-23 Adopted Budget is largely attributed to an increase in revenues from patient services and intergovernmental funding. The California Department of Health Care Services announced the approval of California Advancing and Innovating Medi-Cal (CalAIM) by the Centers for Medicare and Medicaid Services (CMS) in December 2021. This is the new Waiver for California’s public safety net providers effective January 1, 2022 through December 31, 2026.

The funding levels and regulations for Medicaid funding continues to be evaluated by the Centers for Medicaid and Medicare. NMC will be monitoring the CAiAIM initiative (California Advancing and Innovating Medi-Cal) that may impact utilization of inpatient/outpatient hospital services and reimbursement. CalAIM may become the proposed model for a new five year Medicaid waiver through CMS with different reporting requirements and new payment methodology.

NMC has a capital project fund to provide funding for capital projects exceeding \$100,000 in cost. NMC transfers funding as needed from the enterprise fund to the capital project fund and draws from the fund to pay for the projects. The Recommended Budget includes a net transfer in from the capital project fund to the enterprise fund of \$9.6 million to cover expenditures for projects like the Nursecall System Replacement, Pharmacy Remodel, and Laboratory Remodel.

Road Fund

The Recommended Budget for the Road Fund includes \$76.2 million in expenditures: \$46.5 million in projects, \$19.9 million in road and bridge maintenance, and \$9.7 million for general engineering, administration, and support to other funds. Expenditures are supported by an estimated \$61.6 million in revenues, requiring the use of \$14.6 million in fund balance.

Road Fund	Actuals 2021-22	Adopted Budget 2022-23	Current Year Estimate 2022-23	Recommended 2023-24
A. Beginning Fund Balance	\$22,915,365	\$18,316,076	\$18,316,076	\$ 20,098,946
B. Revenue	41,739,408	79,607,646	66,036,485	61,572,791
C. Total Financing, A+B	64,654,773	97,923,722	84,352,561	81,671,737
D. Expenditures	46,338,697	77,068,999	64,253,615	76,196,989
E. Ending Fund Balance, C-D	\$18,316,076	\$20,854,723	\$20,098,946	\$ 5,474,748

The Road Fund has multiple funding sources, which include State Highway User Tax Account (HUTA) (\$13.0 million); Road Maintenance and Rehabilitation Account (RMRA)/Senate Bill 1 (SB1) (\$11.2 million); local use sales tax ordinance, Measure X (\$9.3 million); funding through grants and programs like the Federal

Highway Administration (FHWA) and Regional Surface Transportation Block Grant Program (RSTP) (\$17.8 million); traffic impact fees (\$2.1 million); General Fund strategic reserve contribution for December/January storm damages (\$0.8 million); and interest, non-road reimbursable work and miscellaneous revenues (\$1.2 million). The \$18.0 million decrease in estimated revenues compared to FY 2022-23 Adopted Budget revenues is from the near completion of the Bradley Road Bridge Scour Repair and Hartnell Road Bridge Replacement projects.

The Road Fund receives a contribution from the Transient Occupancy Tax (TOT) used to meet HUTA, SB 1, and Measure X Maintenance of Effort (MOE) requirements. The MOE stipulates the County provide General Fund resources for street and highway purposes so that state and local funds supplement, not supplant, transportation expenditures. The MOE is based on the amount expended in FY 2016-17 when Measure X passed (\$4.9 million) and is indexed annually to the Engineering News Record construction index, per ordinance. The Recommended Budget includes a TOT contribution of \$6.2 million to meet the MOE requirement.

The Road Fund work plan includes \$46.5 million in projects, including the reconstruction of Harkins Road-Hunter Lane (\$5.5 million); construction of Las Lomas Drive Bike (\$2.9 million); continuing preliminary design of Laureles Grade Road/Carmel Valley Road (\$2.1 million); design of Palo Colorado MP 4.0 to 7.8 (\$3.0 million); construction of the Alisal Road Rehabilitation Project (Salinas at Hartnell Road, \$5.0 million); and design and construction for the Community Pavement/Bond Program (\$8.6 million, slated to use a combination of fund balance and potentially Certificates of Participation bonds). Road and bridge maintenance of \$19.9 million includes the Community Road Maintenance Program (\$10.6 million); annual Pavement Management Seal Coat (\$2.0 million); bridge and traffic maintenance (\$3.4 million); and operational contingencies and strategic reserve to fund emergencies associated with natural disasters or other events (\$4.0 million).

In February and March 2023, the State experienced atmospheric rivers that brought record-breaking rainfall and widespread flooding. This compounded damages to County roads and infrastructure caused by the December/January storms. In both instances, a Presidential Declaration of Disaster was made, opening access to federal aid. The General Fund Strategic Reserve provided advance funding for the December/January damages, with the expectation it would be repaid with reimbursements from the Federal Emergency Management Agency (FEMA) and/or State Office of Emergency Services (CalOES). The County is assessing advance funding options for the February/March storms.

Overall, the estimated beginning fund balance of \$20.1 million is projected to decrease to \$5.5 million as planned Measure X and SB 1 funded projects are initiated and completed. Last year, additional Public Works Engineering staff were added at strategic levels to deliver more projects and align expenditures with revenues. The current Recommended Budget includes additional maintenance staff to incorporate a more considerable geographical impact in repairing and improving County transportation infrastructure (roads, bridges, and traffic appurtenances).

County Library Fund

The Monterey County Free Libraries (MCFL) was established in 1911 to provide library services to communities. Library operations are primarily funded through its own share of property tax.

The Recommended Budget includes \$11.4 million in expenditures financed by \$11.6 million in anticipated revenues, adding \$233,577 to fund balance. Expenditures decrease by \$1.7 million and revenues decrease \$1.4 million. The appropriation and revenue decrease are attributed to a one-time expenditure of \$1.8 million for a contribution

Monterey County Free Library	Actuals 2021-22	Adopted Budget 2022-23	Current Year Estimate 2022-23	Recommend 2023-24
A. Beginning Fund Balance	\$ 5,378,437	\$ 6,097,793	\$ 6,097,793	\$ 6,669,037
B. Revenue	11,571,387	13,003,540	12,933,540	11,644,157
C. Total Financing, A+B	16,949,824	19,101,333	19,031,333	18,313,194
D. Expenditures	10,852,031	13,138,848	12,362,296	11,410,580
E. Ending Fund Balance, C-D	\$ 6,097,793	\$ 5,962,485	\$ 6,669,037	\$ 6,902,614

to the City of Gonzales for the new Gonzales Library construction in the current year, which was funded by the cannabis assignment.

Most of the Library's revenues are derived from property taxes which account for \$10.8 million or 93% of revenues; property taxes are increasing \$514,942 from the adopted budget. Operating transfers from the General Fund decrease \$1.8 million, due to the one-time transfer in the current year for the Gonzales Library.

Local Revenue Fund 2011

The local revenue fund supports public safety, behavioral health, and social services programs. Next fiscal year, revenue increases to \$93.5 million, while expenditures (operating transfers out for the various public safety, health and social services programs) total \$97.3 million, exceeding revenues by \$3.8 million. The use of fund balance is primarily to cover authorized uses in probation and social services programs.

Local Revenue Fund 2011	Actuals 2021-22	Adopted Budget 2022-23	Current Year Estimate 2022-23	Recommend 2023-24
A. Beginning Fund Balance	\$33,648,633	\$51,462,458	\$51,462,458	\$58,246,417
B. Revenue	87,236,344	83,670,169	94,508,466	93,536,370
C. Total Financing, A+B	120,884,977	135,132,627	145,970,924	151,782,787
D. Expenditures	69,422,519	86,679,486	87,724,507	97,332,470
E. Ending Fund Balance, C-D	\$51,462,458	\$48,453,141	\$58,246,417	\$54,450,317

Behavioral Health Fund

The Recommended Budget for the Behavioral Health Fund includes expenditures and revenues of \$165.4 million and \$158.5 million, respectively. Expenditures increase by \$8.0 million, and revenue increases \$8.2 million from the FY 2022-23 Adopted Budget. The increase in expenditures is attributable to increases in salaries and benefits due to wage studies that resulted in higher wages (Medical Assistants, Social Workers, and Patient Financial Services Specialists), negotiated wage increases to all employees, and planned construction updates to the Pearl Street building. The increase in revenues is attributable to higher 2011 Realignment revenues. The Recommended Budget provides a sustained level of programmatic expenditures. The recommended use of fund balance of \$6.9 million supports Behavioral Health’s one-time expenditures to the Pearl Street building, MHSA Innovation, MHSA Workforce Education and Training totaling \$3.0 million, and Whole Person Care uses \$3.8 million in fund balance to support staff augmentation in Public Health for implementation of the Enhanced Care Management (ECM) program and funding to offer patients legal assistance from the California Rural Legal Assistance (CRLA) provided by clinics. Overall, revenue in the fund helps support the provision of a comprehensive array of behavioral health and substance use disorder services both in-house and through contracts with community-based organizations and culturally competent providers.

Behavioral Health	Actuals 2021-22	Adopted Budget 2022-23	Current Year Estimate 2022-23	Recommend 2023-24
A. Beginning Fund Balance	\$50,260,485	\$61,287,939	\$61,287,939	\$57,237,787
B. Revenue	156,976,888	150,279,106	139,961,602	158,514,333
C. Total Financing, A+B	207,237,373	211,567,045	201,249,541	215,752,120
D. Expenditures	145,949,434	157,398,704	144,011,754	165,371,312
E. Ending Fund Balance, C-D	\$61,287,939	\$54,168,341	\$57,237,787	\$50,380,808

Health and Welfare Realignment Fund

The health and welfare realignment fund supports social services and health programs, through sales tax and Vehicle License Fees (VLF) apportioned by the State. The Recommended Budget includes expenditures of \$75.2 million and revenues of \$65.4 million. Expenditures are estimated to increase by \$8.5 million while revenues decrease \$0.5 million, resulting in a \$9.7 million reduction to fund balance in FY 2023-24. Use of fund balance is largely due to Health’s one-time AB 85 redirection payment of \$6.0 million and increased programmatic costs of \$2.3 million.

Health & Welfare Realignment	Actuals 2021-22	Adopted Budget 2022-23	Current Year Estimate 2022-23	Recommend 2023-24
A. Beginning Fund Balance	\$45,112,575	\$56,606,442	\$56,606,442	\$59,570,588
B. Revenue	76,449,297	65,847,489	68,903,635	65,360,947
C. Total Financing, A+B	121,561,872	122,453,931	125,510,077	124,931,535
D. Expenditures	64,955,430	66,709,183	65,939,489	75,220,982
E. Ending Fund Balance, C-D	\$56,606,442	\$55,744,748	\$59,570,588	\$49,710,553

Emergency Communications Fund

The Emergency Communications Department operates from a Special Revenue Fund to provide emergency and non-emergency call answering and dispatch services to law enforcement, fire and emergency medical response agencies across the County. Costs are shared pursuant to the cost sharing formula in the 9-1-1 Service

Emergency Communications	Actuals 2021-22	Adopted Budget 2022-23	Current Year Estimate 2022-23	Recommend 2023-24
A. Beginning Fund Balance	\$ 1,653,257	\$ 3,270,862	\$ 3,270,862	\$ 2,994,868
B. Revenue	13,359,054	13,238,353	12,615,703	14,188,933
C. Total Financing, A+B	15,012,311	16,509,215	15,886,565	17,183,801
D. Expenditures	11,741,449	12,909,353	12,891,697	14,734,982
E. Ending Fund Balance, C-D	\$ 3,270,862	\$ 3,599,862	\$ 2,994,868	\$ 2,448,819

Agreement which allocates costs based on an equally weighted three-factor ratio of Population, Assessed Value, and Workload for each user agency. For every dollar of cost, approximately 70 percent is collected as revenue from non-County users and 30 percent is paid by the County for service provided to the County Sheriff and Probation Department and to subsidize the Fire Districts costs.

The Recommended Budget includes \$14.7 million in expenditures, financed by \$14.2 million in revenue, and \$546,049 use of fund balance. The Recommended Budget includes a contribution to the Dispatch Reserve of \$329,000. Overall expenditures increase \$1.8 million primarily due a \$1.0 million increase in salary & benefits costs driven by a 16.94% wage increase for Dispatcher Series staff, a \$500,000 increase in overhead charged through the cost allocation plan, and \$200,000 increase for rehosting of the Computer Aided Dispatch (CAD) system. Cost increases will be financed by revenue from the various users and the County which increases \$950,580 over the adopted budget and planned fund balance use of \$546,049 due to previous year's surplus held as fund balance.

Parks Lake & Resort Operations

The Parks Lake and Resort Operations Fund is an enterprise fund for the operations of Nacimiento Resort & Recreation Area (Lake Nacimiento). Lake Nacimiento is a self-supporting entity, providing goods and services to the public for a fee. It is managed under an agreement with an external operator, Vista Recreation. The agreement allows for reimbursement of the operator's expenditures in addition to a monthly management fee and annual incentive fee. The County is responsible for capital expenses such as repairs to infrastructure.

Parks Lake & Resort Operations	Actuals 2021-22	Adopted Budget 2022-23	Current Year Estimate 2022-23	Recommend 2023-24
A. Beginning Fund Balance	\$ 1,903,567	\$ 2,323,807	\$ 2,323,807	\$ 1,896,415
B. Revenue	3,976,263	4,603,639	3,271,332	3,936,796
C. Total Financing, A+B	5,879,830	6,927,446	5,595,139	5,833,211
D. Expenditures	3,556,023	4,193,603	3,698,724	3,686,682
E. Ending Fund Balance, C-D	\$ 2,323,807	\$ 2,733,843	\$ 1,896,415	\$ 2,146,529

The Recommended Budget for FY 2023-24 includes revenues of \$3.9 million and expenditures of \$3.7 million, for a net income of \$0.3 million. Revenue assumes average-high water levels, with increased patronage and a solid summer season compared to the current year estimate. The Recommended Budget anticipates that the recent purchase of ten new boats, kayaks and paddle boats will increase boat rental, day use, lodging, camping, and fuel sales revenue. The 2022-23 winter storms caused water intrusion in some of the rental lodges, currently being investigated, which could result in reduced lodging revenues and costly repairs.

Expenditures are projected at \$3.7 million due to a reduction in building and improvement maintenance, non-capital equipment expense, personnel services, interest on long-term debt and cost plan allocation. The anticipated savings from these expenses will not significantly reduce the total expenditures, as Vista operating costs will rise. The projected surplus will result in an increase to fund balance from \$1.9 million to \$2.1 million.

Laguna Seca Recreation Area

Laguna Seca Recreation Area (LSRA), an enterprise fund, operates as a fee-for-service entity. LSRA provides services that include camping, daily track rentals, venue rentals, corporate team-building packages, and ticket sales to special events. Special events range from small local gatherings to world-renowned international events.

Laguna Seca Recreation Area	2021-22	Adopted 2022-23	Current Year 2022-23	2023-24
A. Beginning Fund Balance	\$11,500,417	\$ 9,931,812	\$ 9,931,812	\$ 9,178,853
B. Revenue	20,238,012	18,044,645	16,982,410	27,031,008
C. Total Financing, A+B	31,738,429	27,976,457	26,914,222	36,209,861
D. Expenditures	21,806,617	18,560,643	17,735,369	27,293,894
E. Ending Fund Balance, C-D	\$ 9,931,812	\$ 9,415,814	\$ 9,178,853	\$ 8,915,967

The FY 2023-24 Recommended Budget includes \$27.0 million in revenues, which is 59% higher than the current year's estimate, to reflect LSRA's goal of reaching pre-pandemic operating results. Revenues from raceway patron attendance are projected to increase significantly after the Start/Finish Bridge and Track Resurfacing projects are completed. Calendar year events for latter half of 2023 and first half of 2024 are scheduled and expected to gain a lot of attention worldwide.

FY 2023-24 expenditures of \$27.3 million are budgeted at 54% higher than current year estimate as a direct result of an increase in operating activities. Expenditures include the reimbursement of 20% sponsorship match of \$1.6 million, advanced for cash flow purposes, from General Fund Contingencies for the Start/Finish Bridge project.

Operating expenditures of \$23.2 million, include various expenses for professional and special services, equipment rents and leases and other special expenses, medical ambulance and other related medical services required for most big events, anticipated costs for temporary services during events, insurance, sales and related tax assessments, food, uniforms, operating supplies, communications, and other utilities. These direct costs which comprise 85% of the total expenditures, are 50% higher than current year estimate. Other expenditures include \$2.6 million in cost plan charges. Depreciation expense is budgeted to be 12% more compared to the current-year estimate, to include depreciation for the new Start/Finish Bridge and Track, which will be in full operation beginning FY 2023-24. Total net results will decrease the fund balance from \$9.2 million to \$8.9 million.

Budget Hearings

Budget hearings to consider the FY 2023-24 Recommended Budget are scheduled to begin on Wednesday, May 31, 2023. The budget hearing schedule will be available online at the Monterey County Clerk of the Board's website on or around Friday, May 19, 2023.

Appropriation Limits

Article XIII B of the California State Constitution, Proposition 4, or the Gann Limitation, requires local agencies to calculate an appropriations limit, compile revenues that are subject to this limit, and make a comparison between the two. If the local agency's revenues (tax proceeds) exceed the limit, the law allows the voters to approve the increase, or the political entity must return the excess revenues to the taxpayers within two years.

The calculations for the County's general fund and library fund appropriations limit are prepared by the Auditor-Controller's Office with assistance from the County Administrative Office. All districts are within their limits.

Supplemental Charts

This section provides supplemental information on the Recommended Budget including recommended appropriations by fund and department, general fund expenditures and revenue, general fund contributions, information on the County’s strategic reserve, and countywide positions.

Chart 1. Recommended Appropriations by Fund, All Funds (Millions)

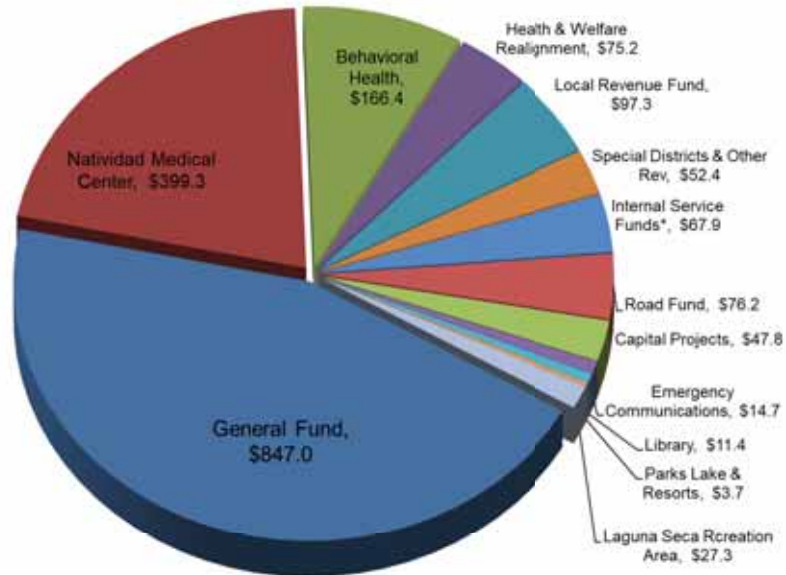

* Includes programs for general liability, workers' compensation, ERP planning, and employee benefits.

Chart 2. General Fund Appropriations by Department (Millions)

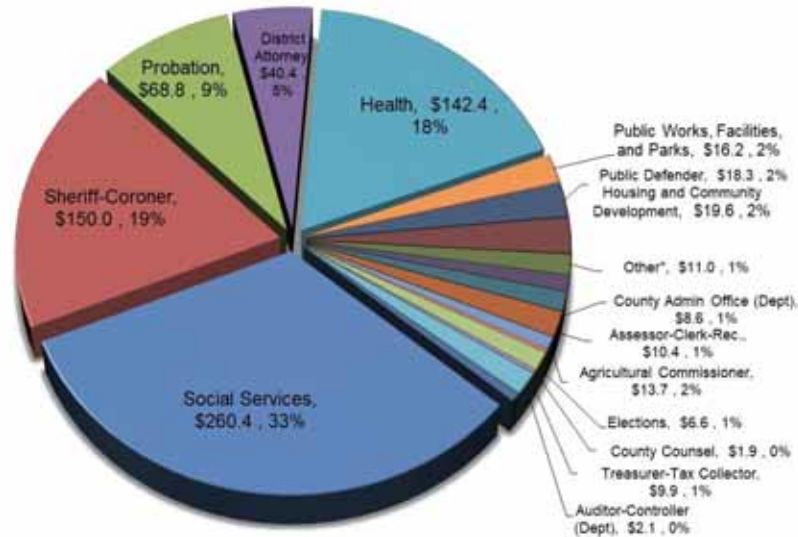

Excludes non-departmental costs.
 *Includes Human Resources, Board of Supervisors, Clerk of the Board, Civil Rights Office, Dept. of Emergency Management, and Cooperative Extension. Chart excludes non-departmental costs such as bond payments, trial courts, contributions to fire districts and

Chart 3. General Fund Expenditures by Category (Millions)

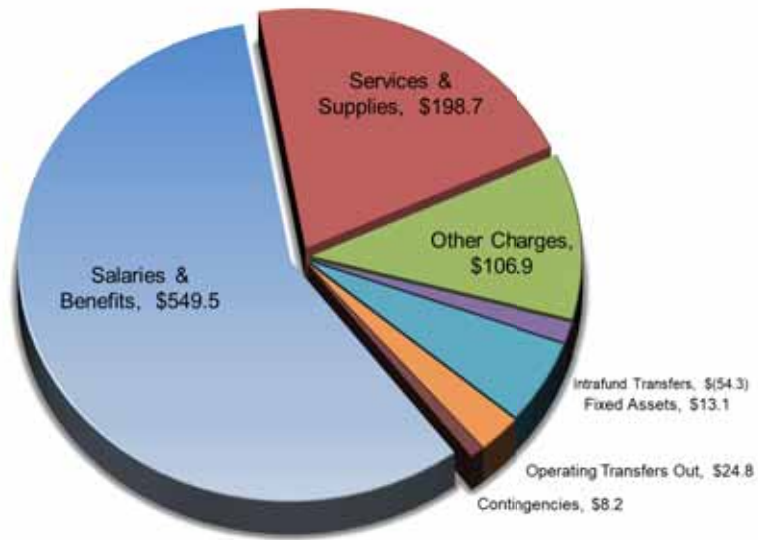

* Other Charges include \$80.4 million for public assistance & out of home care payments. Intrafund Transfers of \$54.3 million are reflected as negative expenditures and represent transfers to County departments for support of various programs/projects from other funds for reimbursement for services provided to non-general fund departments.

Chart 4. General Fund Sources of Revenue (Millions)

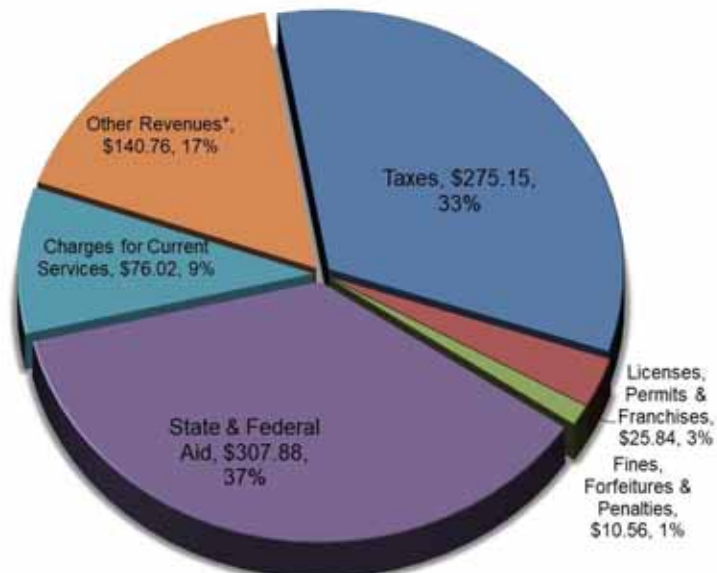

* Includes operating transfers into the general fund from other funds (\$130.0 million), tobacco settlement monies (\$4.5 million), investment income (\$2.3 million), and various miscellaneous revenues.

Chart 5. General Fund Contributions by Department (Millions)

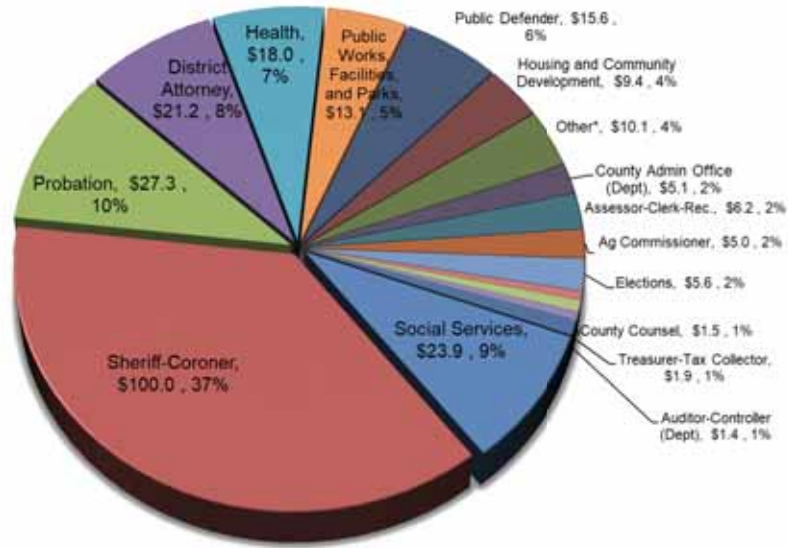

*Includes Human Resources, Board of Supervisors, Clerk of the Board, Civil Rights Office, Dept of Emergency Management, and Cooperative Extension. Chart excludes non-departmental costs such as bond payments, trial courts, contributions to fire districts and other agencies, and various miscellaneous countywide expenditures.

Strategic Reserve

The chart below reflects funds set aside in the strategic reserve. The general fund portion was \$79.3 million at the end of FY 2021-22 representing 9.5% of estimated revenues, just below the 10% policy target. During the current year, the County has utilized \$31.0 million of the reserve. Based on the estimated balance, the reserve is currently at 5.8% of estimated general fund revenues. NMC has a designated reserve of \$25.0 million.

Chart 6. Strategic Reserve (Millions)



County Employees

The table below summarizes the authorized positions in all funds by department and recommended changes from the FY 2022-23 Adopted Budget.

Table 1. Position Summary

Department	2022-23	2023-24	Change
	Adopted	Recommended	
Natividad Medical Center	1,466.9	1,473.0	6.1
Health	1,214.8	1,271.3	56.5
Social Services	919.0	925.0	6.0
Sheriff-Coroner	468.0	468.0	-
Probation	296.5	298.5	2.0
Housing & Community Development	103.0	103.0	-
Public Works, Facilities, & Parks	262.5	277.5	15.0
District Attorney	158.0	160.0	2.0
Child Support Services	82.0	82.0	-
Information Technology	110.0	110.0	-
Ag Commissioner	75.0	75.0	-
Emergency Communications	75.0	75.0	-
Library	65.5	66.5	1.0
Assessor	69.0	65.0	(4.0)
CAO	80.0	76.0	(4.0)
Public Defender	59.0	60.0	1.0
Treas-Tax Collector	49.0	49.0	-
Auditor-Controller	44.0	56.5	12.5
County Counsel	54.0	54.0	-
Human Resources	41.0	42.0	1.0
Board of Supervisors	20.0	20.0	-
Dept. of Emergency Management	-	9.0	9.0
Clerk of the Board	5.0	5.0	-
Cooperative Extension Service	3.0	3.0	-
Civil Rights Office	5.0	5.0	-
Elections	12.0	12.0	-
Total	5,737.2	5,841.3	104.1

Attachment A

Monterey County ARPA Plan Expenditure Summary Updated April 2023						
General Fund						
Department	Spent		Allocated*	Allocated	Allocated	Total Allocated
	FY 2020-21	FY 2021-22	FY 2022-23	FY 2023-24	FY 2024-25	All Years
Ag Commissioner	\$ -	\$ 222,353	\$ -			\$ 222,353
Auditor Controller	\$ -	\$ 167,200	\$ 356,590			\$ 523,790
Board of Supervisors	\$ -	\$ -	\$ 234,506			\$ 234,506
Civil Rights	\$ -	\$ 50,799	\$ 204,767			\$ 255,566
Clerk of the Board	\$ -	\$ -	\$ 102,727			\$ 102,727
County Administrative Office	\$ 4,989,651	\$ 2,669,030	\$ 3,768,762	\$ 1,600,000		\$ 13,027,443
County Administrative Office EOC	\$ 747,169	\$ (747,169)	\$ -			\$ -
County Counsel	\$ -	\$ 107,494	\$ 517,710			\$ 625,204
District Attorney	\$ -	\$ 237,000	\$ 1,687,964			\$ 1,924,964
Health	\$ 2,045,677	\$ 6,329,477	\$ 3,307,419	\$ 483,148	\$ 77,973	\$ 12,243,694
Housing and Community Development	\$ -	\$ 934,112	\$ 520,000			\$ 1,454,112
Human Resources	\$ -	\$ 349,545	\$ 652,659			\$ 1,002,204
Information Technology	\$ -	\$ -	\$ 1,386,149	\$ 1,895,333		\$ 3,281,482
Probation	\$ -	\$ 371,012	\$ 12,560			\$ 383,572
Public Defender	\$ -	\$ 504,002	\$ 559,549			\$ 1,063,551
Public Works Facilities and Parks	\$ 424,720	\$ 3,400,726	\$ 1,414,394	\$ -		\$ 5,239,841
Sheriff Coroner	\$ 504,038	\$ 2,906,798	\$ 3,812,723			\$ 7,223,559
Social Services	\$ 256,989	\$ 223,822	\$ 2,062,293			\$ 2,543,104
Treasurer Tax Collector	\$ -	\$ 61,810	\$ -			\$ 61,810
FY 2023-24 Revenue Loss				\$ 13,126,033		\$ 13,126,033
Totals General Fund	\$ 8,968,245	\$ 17,788,011	\$ 20,600,772	\$ 17,104,514	\$ 77,973	\$ 64,539,515
Other Funds						
	Spent		Allocated	Allocated	Allocated	Total Allocated
	FY 2020-21	FY 2021-22	FY 2022-23	FY 2023-24	FY 2024-25	All Years
Emergency Communications	\$ -	\$ 278,046				\$ 278,046
Public Works - Road Fund	\$ -	\$ 110,000				\$ 110,000
Public Works - Boronda CSD	\$ -	\$ 38,993				\$ 38,993
Public Works - San Jerardo CSD	\$ -	\$ 35,159				\$ 35,159
Public Works - Pajaro CSD	\$ -	\$ -	\$ 1,178,797	\$ 1,160,163		\$ 2,338,960
Public Works - Capital Projects	\$ -	\$ 1,751,986	\$ 7,565,866	\$ 6,386,446	\$ 375,524	\$ 16,079,822
Workforce Development Board Fund	\$ 745,342	\$ 145,425	\$ -			\$ 890,766
Totals Other Funds	\$ 745,342	\$ 2,359,609	\$ 8,744,663	\$ 7,546,609	\$ 375,524	\$ 19,771,746
Grand Total Obligated County	\$ 9,713,586	\$ 20,147,619	\$ 29,345,435	\$ 24,651,123	\$ 453,497	\$ 84,311,261
Federal Allocation						\$ 84,311,261
Unallocated						\$ (0)

*FY 2022-23 Allocated amounts reflect reductions for amounts rolled-over to FY 2023-24.

Attachment B

General Fund – Recommended Augmentations, by funding source

Row Labels	FTE	Expenditures	Revenues	Net Request	Rec. Amount
ARPA Revenue Loss	11.25	13,726,047		13,726,047	13,188,407
Assessor-County Clerk-Recorder	4	594,719		594,719	545,159
Civil Rights Office	0	38,294		38,294	38,294
Cooperative Extension Service	0.25	40,118		40,118	40,118
County Administrative Office	1	1,131,398		1,131,398	1,067,864
Department of Emergency Management	0	95,000		95,000	95,000
District Attorney	1	120,390		120,390	100,325
Elections	0	1,562,858		1,562,858	1,460,659
Health	0	266,000		266,000	266,000
Housing and Community Development	0	320,906		320,906	320,906
Human Resources	0	50,000		50,000	50,000
Information Technology	0	2,200,000		2,200,000	2,200,000
Probation	0	136,182		136,182	136,182
Public Defender	1	292,970		292,970	292,970
Public Works, Facilities & Parks	2	1,803,066		1,803,066	1,523,102
Sheriff-Coroner	0	3,380,255		3,380,255	3,380,255
Social Services	2	1,655,688		1,655,688	1,633,370
Treasurer-Tax Collector	0	38,203		38,203	38,203
ARPA Rollover	0	483,149		483,149	483,149
Health	0	483,149		483,149	483,149
Building Improvement and Replacement	0	950,000		950,000	950,000
Public Works, Facilities & Parks	0	950,000		950,000	950,000
Departmental Revenue	32	4,895,985	4,895,985	-	-
Health	24	3,650,888	3,650,888	-	-
Probation	2	276,385	276,385	-	-
Social Services	6	968,712	968,712	-	-
ERP Funding	19	3,607,728	3,607,728	-	-
Auditor-Controller	12	2,244,917	2,244,917	-	-
County Administrative Office	3	548,760	548,760	-	-
Human Resources	4	814,051	814,051	-	-
General Capital Assignment	0	250,000		250,000	250,000
Elections	0	250,000		250,000	250,000
Grand Total	62.25	23,912,909	8,503,713	15,409,196	14,871,556

All Funds – Recommended Augmentations, by funding source

Row Labels	FTE	Expenditures	Revenues	Net Augmentation	Rec. Amount
001	62.25	23,912,909	8,503,713	15,409,196	14,871,556
ARPA Revenue Loss	11.25	13,726,047		13,726,047	13,188,407
Assessor-County Clerk-Recorder	4	594,719		594,719	545,159
Civil Rights Office	0	38,294		38,294	38,294
Cooperative Extension Service	0.25	40,118		40,118	40,118
County Administrative Office	1	1,131,398		1,131,398	1,067,864
Department of Emergency Management	0	95,000		95,000	95,000
District Attorney	1	120,390		120,390	100,325
Elections	0	1,562,858		1,562,858	1,460,659
Health	0	266,000		266,000	266,000
Housing and Community Development	0	320,906		320,906	320,906
Human Resources	0	50,000		50,000	50,000
Information Technology	0	2,200,000		2,200,000	2,200,000
Probation	0	136,182		136,182	136,182
Public Defender	1	292,970		292,970	292,970
Public Works, Facilities & Parks	2	1,803,066		1,803,066	1,523,102
Sheriff-Coroner	0	3,380,255		3,380,255	3,380,255
Social Services	2	1,655,688		1,655,688	1,633,370
Treasurer-Tax Collector	0	38,203		38,203	38,203
ARPA Rollover	0	483,149		483,149	483,149
Health	0	483,149		483,149	483,149
Building Improvement and Replacement	0	950,000		950,000	950,000
Public Works, Facilities & Parks	0	950,000		950,000	950,000
Departmental Revenue	32	4,895,985	4,895,985	-	-
Health	24	3,650,888	3,650,888	-	-
Probation	2	276,385	276,385	-	-
Social Services	6	968,712	968,712	-	-
ERP Funding	19	3,607,728	3,607,728	-	-
Auditor-Controller	12	2,244,917	2,244,917	-	-
County Administrative Office	3	548,760	548,760	-	-
Human Resources	4	814,051	814,051	-	-
General Capital Assignment	0	250,000		250,000	250,000
Elections	0	250,000		250,000	250,000
022	0	141,417		141,417	141,417
Departmental Revenue	0	141,417		141,417	141,417
Social Services	0	141,417		141,417	141,417
023	17	1,008,128	1,008,128	-	-
Departmental Revenue	17	1,008,128	1,008,128	-	-
Health	17	1,008,128	1,008,128	-	-
025	0	723,399		723,399	723,399
Departmental Revenue	0	723,399		723,399	723,399
Health	0	723,399		723,399	723,399
028	3	437,733	437,733	-	-
Departmental Revenue	3	437,733	437,733	-	-
Emergency Communications	3	437,733	437,733	-	-
151	0	1,160,163		1,160,163	1,160,163
ARPA Revenue Loss	0	1,160,163		1,160,163	1,160,163
Public Works, Facilities & Parks	0	1,160,163		1,160,163	1,160,163
404	0	1,488,000		1,488,000	1,488,000
ITD Assignment	0	1,488,000		1,488,000	1,488,000
Public Works, Facilities & Parks	0	1,488,000		1,488,000	1,488,000
Grand Total	82.25	28,871,749	9,949,574	18,922,175	18,384,535

Unfunded Augmentations, by Department

Row Labels	FTE	Expenditures	Revenues	Net Request
001	31	14,477,774	96,000	14,381,774
Assessor-County Clerk-Recorder	4	389,109		389,109
SQ Vacant Assessment Clerkor Appraiser II	1	91,673		91,673
SQ Vacant Map Drafting Tech	1	105,425		105,425
SQ Vacant Property Transfer Clerk	1	90,012		90,012
Status Quo Vacant OAlll	1	101,999		101,999
Auditor-Controller	4	548,225		548,225
New Accounting Technician	1	107,906		107,906
New Accountant Auditor II	1	137,255		137,255
New Internal Auditor II	1	137,255		137,255
New Internal Auditor III	1	165,809		165,809
Civil Rights Office	0	14,000		14,000
Status Quo ASL and Document Translation	0	14,000		14,000
County Administrative Office	2	748,037		748,037
AUG-C/P Management Analyst II	1	171,202		171,202
AUG-Econ Dev Association Memberships	0	12,000		12,000
AUG-Econ Dev Conferences/Lodging/Travel/Marketing	0	7,000		7,000
AUG-Grant Writing (Regional Climate Proj Work Grp Meml)	0	20,000		20,000
AUG-IGLA Homeless Management Analyst I	1	152,835		152,835
AUG-IGLA Homeless_Encampment Mitigation Program	0	100,000		100,000
AUG-Monterey County Violence Prevention Initiative Updat	0	190,000		190,000
AUG-Sustainability Operating Budget	0	95,000		95,000
Department of Emergency Management	0	315,000		315,000
AUG-Duty Officer Vehicle	0	80,000		80,000
AUG-EOC Site Review and Needs Assessment	0	80,000		80,000
AUG-Grant Program Development	0	115,000		115,000
AUG-Outreach/ Website Development	0	40,000		40,000
District Attorney	0	1,294,000		1,294,000
Digital File Conversion-Phase 1	0	94,000		94,000
Digital File Conversion-Phase 2	0	1,200,000		1,200,000
Health	0	2,509,101	96,000	2,413,101
ASB - Shelter Expansion	0	774,975		774,975
ASB-Mobile Clinics	0	240,000	96,000	144,000
EH-Cameras	0	8,000		8,000
EH-Pilot IDLATF	0	120,000		120,000
First 5 - ECE Career Pathways	0	350,000		350,000
First 5 - ECE Community Outreach, Inclusion and Advocac	0	225,000		225,000
First 5 - Informal Caregiver Strategic Priorities	0	300,000		300,000
Public Health Cannabis Education Program	0	225,000		225,000
Public Health Employee Wellness Program	0	183,126		183,126
Schilling Place Fitness Center - Employee Wellness Progr	0	83,000		83,000
Housing and Community Development	6	1,142,046		1,142,046
Associate Planner	2	310,936		310,936
Business Technology Analyst I	1	149,152		149,152
Code Compliance Inspector II	1	142,045		142,045
GIS Analyst II	1	160,308		160,308
Housing Housekeys	0	120,000		120,000
Permit Technician III	1	135,955		135,955
Vacation Short Term Rentals	0	123,650		123,650
Human Resources	2	441,205		441,205
New Risk & Benefits Specialist-Conf.	1	126,035		126,035
Qualtrics Agreement	0	88,455		88,455
Status Quo Vacant HR Program Manager	1	226,715		226,715
Probation	0	102,104		102,104
AUG-Leave Buyback Unit M, N, L, F, J, X & Y	0	102,104		102,104
Public Works, Facilities & Parks	6	2,893,679		2,893,679
County Park Ranger II	1	133,488		133,488
Custodial Services in Multi Use Facilities	0	950,000		950,000
Facilities COVID19 Related	0	125,000		125,000
Park Services Aide II	1	85,496		85,496
Parking Citation Processing	0	20,000		20,000
Parks Building & Grounds Worker II	1	98,411		98,411
Parks Building & Grounds Worker Supervisor	2	229,964		229,964
Real Property Specialist	1	188,551		188,551
Salary & Benefit Savings Parks	0	487,769		487,769
Security Services at Government Center & Schilling	0	575,000		575,000

Unfunded Augmentations – Continued

Sheriff-Coroner	7	3,844,148		3,844,148
Generator for the Sheriff's Admin Building	0	200,000		200,000
New Cannabis Vehicle	0	140,000		140,000
New Position Accountant III	1	165,809		165,809
New Position Accounting Technician	1	107,906		107,906
New Position DISC	1	136,137		136,137
New Position Sheriff's Commander	1	288,242		288,242
New Position Sheriff's Records Director	1	187,615		187,615
New Position Sheriff's Records Specialist II	1	103,402		103,402
New Position Sheriff's Sergeant	1	236,908		236,908
Restore Funding of 5 Deputy Sheriff-Corrections	0	949,129		949,129
UpFit of 21 New Vehicles	0	700,000		700,000
VRP Catch Up for 35 Patrol Vehicles	0	629,000		629,000
Social Services	0	102,120		102,120
General Assistance	0	102,120		102,120
Treasurer-Tax Collector		135,000		135,000
Remittance Processor (Replacement)		135,000		135,000
021	0	40,000		40,000
County Administrative Office	0	40,000		40,000
WDB SUPPORT SERVICES	0	40,000		40,000
Grand Total	31	14,517,774	96,000	14,421,774

Capital Projects – Unfunded Augmentations

Capital Projects	Expenditures	Revenues	Net Request
404	80,103,121		80,103,121
Capital Improvements	80,103,121		80,103,121
076588 - Computerized Maintenance Management System CMMS	350,000		350,000
1702 Soledad Behavioral Health Center - New Facility	5,125,000		5,125,000
1703 E Salinas Integrated Health Center	478,245		478,245
1801-Marina Clinic General Repairs	1,296,950		1,296,950
1802-1 - Health Offices General Repair	911,635		911,635
1802-3 Health - Install New Laboratory HVAC System	1,039,743		1,039,743
1803-1 - Health Animal Services General Repairs	1,477,000		1,477,000
1803-2 Health Animal Services: Replace 5 HVAC Units	1,002,085		1,002,085
1902 Greenfield Behavioral Health & WIC Center	5,125,000		5,125,000
1903 - Relocate/Expand Marina Family Health Center	100,000		100,000
1930-107-County Building Video Conference Equipment Installa	100,000		100,000
1930-FAC-04-ITD Facility Interior Painting	150,000		150,000
1930-IT-21-04-Zoom Softphone Deployment	150,000		150,000
1930-IT-22-02-Network Connectivity and Redundancy	250,000		250,000
1930-IT-22-04-ITD Data Center Fire Suppression System	664,350		664,350
1930-IT-23-02-ITD Data Center Network (ACI Spine & Controlle	300,000		300,000
2020-02 - Public Safety Building Employee Parking Lot lights	153,932		153,932
2020-03 1410 Natividad - Replace Various HVAC System Units	222,000		222,000
2021-1 - Laurel Yard Bldg H General Repairs	380,160		380,160
2205-Public Health Laboratory Upgrades	151,809		151,809
2302 - Health Laboratory Modular Storage	1,447,600		1,447,600
816706 Juvenile Division HVAC/Ceiling Repairs	6,657,412		6,657,412
8419 Parking Lot Alternative at Church and Gabilan Streets	2,800,000		2,800,000
8477-1 Lake Nacimiento Resort Lodge Replacement	1,000,000		1,000,000
8477-5 Lake Nacimiento Resort Road Repairs	100,000		100,000
8510-8386-1 Lake San Antonio - North Shore Amphitheater	1,000,000		1,000,000
85108510-8387-1 Lake San Antonio Replacement Marina	300,000		300,000
8786 Youth Center Security Camera System 670 Circle Dr	655,183		655,183
881317 - East Garrison - Demolition Estimates for the former	200,000		200,000
Admin 2021-01 EV Electric Charging Stations	385,000		385,000
DSS-17-01-Women's Shelter Kitchen Upgrades & General Repairs	3,276,948		3,276,948
DSS-18-01 Seaside Community Benefits Office Replacement	175,000		175,000
Fleet 2019-02-Laurel Yard Bldg A Roof Repairs	376,142		376,142
Fleet 2020-04 - Laurel Yard Bldg A Paint & Flooring	288,399		288,399
L-1603 New Bradley Branch Library Study and Development	586,042		586,042
L-1605 Pajaro Library Branch Rehabilitation	350,000		350,000
NJH-2020-01 Juvenile Hall Concrete Exterior Fence Pathway	219,018		219,018
Park-22-05 - Lake San Antonio Oak Room Renovation	200,000		200,000
Parks-22-02 Laguna Seca New Radios	600,000		600,000
Parks-22-03 - Purchase Heavy Equipment/Tractor for N County	300,000		300,000
Parks-22-04-Parks Roof Replacement Program	400,000		400,000
Parks-22-06 - Lake San Antonio Administration Building Renov	360,000		360,000
Parks-22-07 San Antonio North and South Shore Road Repairs	500,000		500,000
Parks-22-08 Lake San Antonio Campsite Pad resurfacing	200,000		200,000
Parks-22-10 Parks Amenities Replacement Program	250,000		250,000
Parks-22-11 Ft Ord Travel Camp - Parking & Restroom	180,000		180,000
PD 2017-02 - Youth Center Portable Building Repairs	219,072		219,072
PD 2017-04 Juvenile Division Restroom Remodel	212,749		212,749
PD 2017-05-Juvenile Division Security and Fire Alarm Upgrade	298,124		298,124
PD 2022-02 - Youth Center Exterior Lighting and Security	439,933		439,933
PD 2022-03	748,372		748,372
PD 2022-04 - Juvenile Hall: Additional Gutters/Water Intrust	451,066		451,066
PD 2022-05 Juvenile Hall: Sewer Grinder-Assess Low Flow	109,000		109,000
PD 2022-06 Juvenile Hall: DG Pathway Upgrade	689,214		689,214
PD 2022-07 - Juvenile Hall Epoxy Flooring Repair/Replace	25,000		25,000
PD 2022-08 - Juvenile Hall: Interior Landscape Improvements	25,000		25,000
PD 2022-1 Youth Center Repave Recreation Area	178,240		178,240
PWFP 2017-03-Laurel Yard Cldg N Roof Repairs	605,079		605,079
PWFP 2017-05-Laurel Yard Bldg N Roof Repairs	389,661		389,661
PWFP 2019-01-Laurel Yard Bldg H Roof Repair	485,647		485,647
PWFP 2019-03-OES/911 Roof Replacement	1,329,123		1,329,123
PWFP 2019-06- Youth Center Indoor Energy Efficient Lights	189,268		189,268
PWFP 2019-07- Sheriff Public Safety Building Energy Efficient	347,162		347,162
PWFP 2019-08- Juvenile Division Energy Efficient Lights	164,719		164,719
PWFP 2019-09 King City Courthouse Parking Lot Repaving	1,927,940		1,927,940
PWFP 2019-13- Laurel Yard New Fencing and Gates	5,586,631		5,586,631
PWFP 2019-14 Repave Monterey Courthouse Parking Lot	1,539,494		1,539,494

Capital Projects – Unfunded Augmentations – continued

PWFP 2020-01-Add Cameras in Schilling Campus Parking Lots	145,384	145,384
PWFP 2020-02-Laurel Yard Replace/Install New Security Camera	376,836	376,836
PWFP 2020-03 - Upgrade Fleet Parking Lot Fence	229,405	229,405
PWFP 2020-04 - Courthouse Parking Lot Structure Repairs	266,251	266,251
PWFP 2020-10-Juvenile Division Parking Lot Repair & Repaveme	847,591	847,591
PWFP 2022-09 -168 W Alisal Master Plan Development and Imple	100,000	100,000
PWFP 2022-10 - 855 E Laurel Dr, Bldg A & B Roll Up Garage Do	235,831	235,831
PWFP 2023-03 Greenfield PW Yard Replacement Office	75,000	75,000
PWFP 2023-04 - King City Courthouse Facility Maintenance	75,000	75,000
PWFP 2023-06-Pajaro CSD Manhole Upgrade, Phase 2	500,000	500,000
PWFP 2023-07-Pajaro CSD Sewer Line Upgrades	1,850,000	1,850,000
PWFP 2023-08 - 855 E Laurel - Skate and Bike Park	400,000	400,000
PWFP 2023-09-Pajaro CSD Lift Station Upgrades	525,000	525,000
PWFP 2023-10-Chular CSA Wastewater System	565,000	565,000
PWFP 2023-11-Boronda CSD Lift Station Upgrade	704,000	704,000
PWFP 2023-12-San Jerardo Water System Additional Repair Work	375,000	375,000
PWFP 2023-13-Lake San Antonio N & S Shore Water System Pha	1,525,000	1,525,000
PWFP 2023-14-Lake San Antonio South WasteWater System Addi	375,000	375,000
PWFP 2023-15-Toro Park Water System Additional Upgrades	793,000	793,000
PWFP 2023-16-Toro Park Wastewater System Additional Upgrades	275,000	275,000
PWFP 2023-17-Lake Nacimiento Water Intake Line	2,600,000	2,600,000
PWFP 2023-18 - Control System (SCADA) for CSD-CSA Pumps	450,000	450,000
PWFP 2023-19-Pajaro CSD Force Main Rehab	6,400,000	6,400,000
PWFP 2023-20- Las Lomas Landslide Stabilization	2,000,000	2,000,000
SO-22-01 - Existing Jail Borms A-D Replace Cinderblock walls	219,676	219,676
Grand Total	80,103,121	80,103,121



This page intentionally left blank.

Appropriation Limits

COUNTY OF MONTEREY
APPROPRIATION LIMITS FOR THE 2023 - 24 FISCAL YEAR
 Pursuant to Article XIIB of the California Constitution

<u>FUND</u>	<u>1978-79</u> <u>Base Year</u>	<u>Appropriation</u> <u>Limit</u>	<u>Estimated</u> <u>Tax Proceeds</u>	<u>State</u> <u>Subventions</u>
County General and Library Funds	\$33,688,425	\$ 866,862,812	\$ 297,211,828	\$ 106,800,000
<u>Special Districts</u>				
052 CSA # 9 Oak Park	42,702	492,793	47,569	
053 CSA # 10 Laguna Seca Ranch	9,658	111,456	-	
055 CSA # 14 Castroville	530,743	6,124,926	-	
056 CSA # 15 Serra Village, Toro Park	87,250	1,006,890	173,156	
059 CSA # 20 Royal Estates	4,977	57,436	2,437	
062 CSA # 25 Carmel Valley Country Club	9,339	107,775	45,678	
063 CSA # 26 New Moss Landing Heights	1,026	11,840	3,334	
066 CSA # 32 Green Valley Acres	1,836	21,188	4,168	
069 CSA # 35 Paradise Park	5,283	60,967	6,604	
072 CSA # 41 Gabilan Acres	2,727	31,470	10,235	
076 CSA # 47 Carmel Views	5,013	57,851	21,647	
077 CSA # 50 Rioway Track	944	10,894	1,432	
079 CSA # 52 Cerro Del Oso	2,055	23,715	5,279	
081 CSA # 54 Manzanita	219	2,527	1,303	
085 CSA # 58 Vista Corado	1,406	16,226	2,552	
086 CSA # 62 Rancho Del Monte	5,363	61,891	10,558	
151 Pajaro County Sanitation District	254,092	2,932,294	289,279	

Appropriation Limits



This page intentionally left blank.

Recommendations

It is recommended that the Board of Supervisors:

1. Hold a Public Hearing on May 31, 2023 at 9:00 a.m. to adopt the Fiscal Year (FY) 2023-24 Appropriation Limits pursuant to Article XIII B of the California State Constitution.
2. Commence Budget Hearings with the County Administrative Office summary presentation of the FY 2023-24 Recommended Budget on May 31, 2023 at 9:00 a.m. and continue Budget Hearings on June 1, 2023 beginning at 9:00 a.m. if necessary.
3. Authorize and direct the County Administrative Office to prepare the FY 2023-24 Adopted Budget Resolution reflecting changes made by the Board during budget hearings, to make any changes in budget units to reflect any position and/or account adjustments approved by the Board during or prior to budget hearings.
4. Authorize and direct the County Administrative Office to adjust, if needed, position counts, appropriations, revenues, fund balances, etc. to correct clerical and inadvertent errors due to erroneous entries in the County's budget system.
5. Authorize the County Administrative Office to amend the General Financial Policies by adjusting the contribution of TOT revenue to the Road Fund from the current rate of 25.0% of County TOT revenue based on prior year audited actuals to \$6,222,054, the FY 2023-24 maintenance of effort (MOE) requirement, effective July 1, 2023. Authorize and direct the County Administrative Office to incorporate in the FY 2023-24 Adopted Budget the updated TOT contribution to the Road Fund.
6. Authorize the County Administrative Office, in the event that any unbudgeted/unassigned fund balance is available at year-end FY 2022-23, to allocate in the following order of priority:
 - a. For support of the *Strategic Reserve* (3111), not to exceed established Board policy of 10% of estimated FY 2022-23 General Fund revenues (excluding NMC Strategic Reserve) as prescribed in the County of Monterey General Financial Policy.
 - b. For the General Fund Contingency Assignment (3113) to help cover unanticipated events or emergencies as prescribed in the County General Financial Policy.
 - c. 115 Pension Trust - funds to be placed in General Fund (3135) and then transferred to Fund 030.
 - d. Cannabis Tax Assignment (3132).
7. Authorize the County Administrative Office to transfer or release to/from assignments associated with the following self-funded programs in the event they require additional funds or have excess funds at the end of FY 2022-23:
 - a. Information Technology Charges Mitigation Assignment (3124).
8. Authorize the County Administrative Office to adjust the FY 2023-24 Adopted Budgets for the other funds under the authority of the Board of Supervisors to reflect the FY 2022-23 year-end final available fund balance.
9. Consider approval and adoption of the *Public Works Annual Work Program* for the Road Fund for Fiscal Year 2023-24. California Code of Regulations Section 994 - Road Construction & Maintenance Activity, and Streets & Highways Code Division 3, Chapter 1, Section 2007 require that a Road Fund budget be submitted to the Board of Supervisors at the same time as other County departments submit their recommended budgets. The RMA - Public Works Annual Work Program outlines planned expenditures within the recommended Work Program (Road Fund) budget by project and activity. It details anticipated administrative, engineering, and reimbursable expenditures along with planned capital project expenses and maintenance activities



This page intentionally left blank.

COUNTY OF MONTEREY
FUND STRUCTURE CHART
FY 2023-24

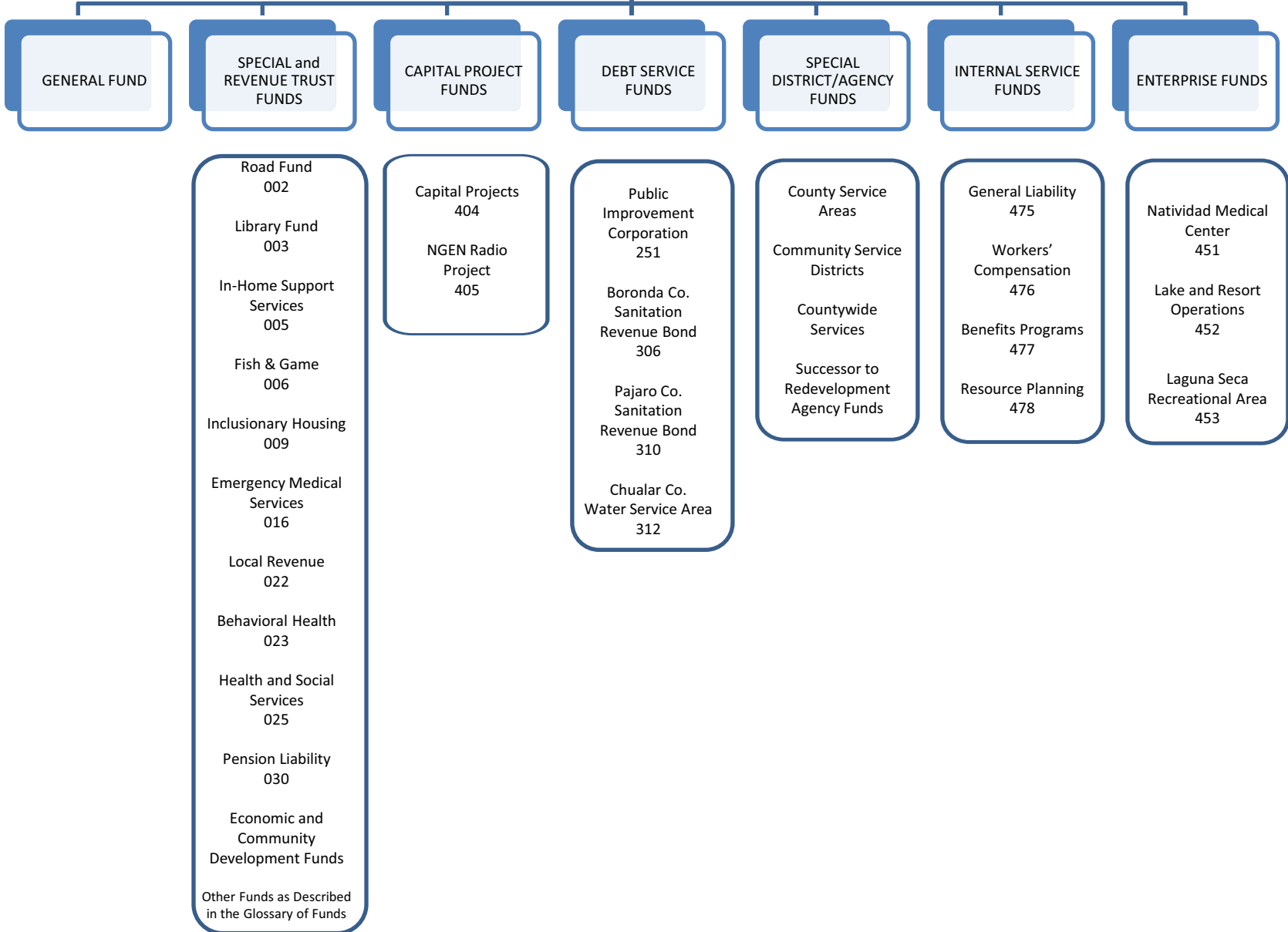

Fund and Organizational Structure Relationship

Departments	Governmental Funds																								Proprietary Funds																
	General Fund	Special Revenue																						Debt Service			Capital Projects		Enterprise			Internal Service									
	001	002	003	005	006	008	009	011	013	016	021	022	023	024	025	026	027	028	029	030	175	180	181	182	CSAs/CDS* (051-093,151-157)	251	306	312	404	405	451	452	453	475	476	477	478				
Board of Supervisors	X																																								
Emergency Management	X												X																												
County Administrative Office	X							X		X										X																			X		
Human Resources	X																																						X		
Civil Rights Office	X																																								
Auditor-Controller	X																									X															
Treasurer-Tax Collector	X																																								
Assessor-County Clerk-Recorder	X																X																								
County Counsel	X																																				X	X			
Clerk of the Board	X																																								
Elections	X																																								
Emergency Communications																X		X																							
Information Technology	X																																								
District Attorney	X											X																													
Child Support Services	X																																								
Public Defender	X											X																													
Sheriff-Coroner	X											X																													
Probation	X											X																													
Agricultural Commissioner	X																																								
Housing and Community Dev.	X						X		X										X		X																				
Public Works, Facilities & Parks	X	X			X																					X	X	X								X	X				X
Health	X									X	X	X		X																											
Social Services	X			X		X					X		X																												
Library			X																																						
Cooperative Extension Service	X																																								
Natividad Medical Center																																									

* includes funds that are component units of Monterey County

Three Year Forecast

Introduction

The County Administrative Office is pleased to present the financial forecast for the County of Monterey. The forecast is the first step of the annual budget development cycle, which concludes with the adoption of a balanced budget by July 1 of each year. To meet this timeline, staff conducts a comprehensive mid-year review of planned spending and anticipated revenues for the current fiscal year (FY 2022-23), budget year (FY 2023-24), and two additional years. The result of this review is an assessment of the County's financial condition, emerging needs, and expected fiscal capacity to meet those needs.

Approach and Assumptions

The forecast is an analysis of estimated revenues and costs for existing levels of staffing and services within the context of current statutes and policies. A forecast is different than a budget. In forecasting, departments estimate "normal" cost of operations, which generally include the filling of vacancies and current level of discretionary spending. Developing a three-year forecast provides a window of opportunity to identify potential actions necessary to balance revenues and expenditures over the long-term to ensure financial sustainability of the County. Similarly, the forecast also serves as a tool for the upcoming budget to assess the impact that decisions made in the present, such as considering a new revenue source or the funding of a new program, will have on future fiscal condition of the County.

The forecast includes employee salary and benefits changes as authorized under existing memorandums of understanding (MOUs) and scheduled employee step advances. The forecast also takes into consideration known increases in PERS retirement rates and health insurance premiums. Revenue estimates are based on the most recent financial data and available information about federal and State funding levels. The forecast compares expenditures required to carry out existing operations related to estimated financing sources. This analysis is a key financial management tool to guide the upcoming budget process and help preserve long-term financial stability.

General Fund Results Prior Fiscal Year

The general fund supports core governmental functions related to public safety, land use and environment, public assistance, health and sanitation, recreation and education, and finance and administration. The FY 2021-22 final modified budget included \$817.2 million in appropriations, matched by an equivalent amount of financing, \$793.1 million in revenue and \$24.1 million in fund balance.

The County ended the fiscal year with a favorable performance compared to the final budget. The general fund ended with revenues of \$758.0 million and expenditures of \$740.3 million which resulted in an initial operating surplus of \$17.7 million. With Board authorization, the budget surplus was used to add to the compensated absences assignment (\$4.0 million), the revenue stabilization assignment (\$783,450), the general capital assignment (\$1.7 million), and (\$250,000) to the Pension Liability Fund for trust and investment management expenses. Lastly, \$432,681 was added to the capital project assignment for planned sustainability energy projects and the COVID-19 county memorial. The CAO estimated ending FY 2021-22 with an unassigned fund balance of \$10.0 million, of which \$6.4 million is utilized in accordance with prior Board approval as a funding source in the FY 2022-23 adopted year. Since the FY 2021-22 Audited Comprehensive Financial Report (ACFR) is not available as of the date of this publication, results are preliminary until the ACFR is published. Investments in the County's reserves are a strong indicator of the County's commitment to weathering future unforeseen events and meet emerging needs.

General Fund Outlook through 2025-26

	2021-22	FY 2022-23			2023-24	2024-25	2025-26
	Actual	Adopted	Modified	Year-End Estimate	Forecast		
Available Financing:							
Beg. Unassigned Fund Balance	\$50.2	\$3.6	\$3.6	\$3.6	\$26.8	\$4.4	\$0.0
Release of Fund Balance	20.3	54.3	56.7	70.1	0.0	0.0	0.0
Revenues	758.0	793.4	794.1	786.6	779.9	792.9	806.8
Total Financing Sources	\$828.5	\$851.3	\$854.4	\$860.3	\$806.7	\$797.3	\$806.8
Financing Uses:							
Assignments/Restrictions	78.2	0.0	0.0	0.0	0.0	0.0	0.0
Expenditures	740.3	843.4	847.5	833.0	806.2	814.9	826.9
<i>Salary Adjustment</i>					(11.1)	(11.4)	(11.5)
Appropriation for Contingencies	0.0	7.9	6.9	0.5	7.2	7.2	7.2
Total Financing Uses	\$818.5	\$851.3	\$854.4	\$833.5	\$802.3	\$810.7	\$822.6
Ending Unassigned Fund Balance	\$10.0	\$0.0	\$0.0	\$26.8	\$4.4	(\$13.3)	(\$15.8)

General Fund Current Fiscal Year Estimated Results

The Board’s vision and support along with responsible stewardship of County departments is evident in the current year, with the County estimating to add \$26.8 million to fund balance at the end of FY 2022-23. This positive result could not have been achieved without continuous management of operational budgets by Departments. The modified budget is not inclusive of transactions occurring after the submission of the current year estimate. Although results are positive for the entire fund, negative results in some departments provide early warning to potential fiscal challenges the County will have to face as it prepares for the FY 2023-24 budget process.

Overall, 19 general fund departments are estimating ending the year within their budget and estimating a \$1.0 million surplus. However, three departments estimate they will end the year over their allocated GFC, resulting in a deficit of \$6.2 million. Significant deficits are estimated for the Assessor- County Clerk Recorder (\$1.3 million), the Sheriff (\$4.7 million), and the District Attorney (\$117,433). Each of these departments will present a report to the budget committee detailing steps they are taking to mitigate the impacts of these deficits. Details for departmental forecasts are provided toward the end of this report.

Expenditures are \$14.5 million lower than the modified budget, revenues are \$7.5 million lower, and therefore contributing a positive

Department	Modified GFC Budget FY 2022-23	Estimated GFC FY 2022-23	Variance
Agricultural Commissioner	\$4,715,700	\$4,425,592	\$290,108
Auditor-Controller	\$1,314,298	\$984,418	\$329,880
Assessor-County Clerk Recorder	\$5,672,511	\$7,021,612	\$(1,349,101)
Board of Supervisors	\$4,795,331	\$4,692,219	\$103,112
Child Support Services	\$84,216	\$82,189	\$2,027
Civil Rights Office	\$381,261	\$313,144	\$68,117
Clerk of the Board	\$1,135,754	\$1,039,273	\$96,481
Cooperative Extension	\$523,772	\$467,209	\$56,563
County Administrative Office	\$9,727,815	\$8,940,011	\$787,804
County Counsel	\$1,359,120	\$1,014,378	\$344,742
District Attorney	\$21,088,065	\$21,205,498	\$(117,433)
Elections Department	\$3,943,908	\$3,938,085	\$5,823
Health	\$26,783,181	\$23,500,374	\$3,282,807
Housing and Community Development	\$11,001,974	\$8,845,264	\$2,156,710
Human Resources	\$1,470,406	\$1,124,517	\$345,889
Information Technology	\$(1,230,701)	\$(1,602,236)	\$371,535
Probation	\$26,963,461	\$26,957,825	\$5,636
Public Defender	\$16,158,833	\$15,547,232	\$611,601
Public Works, Facilities, and Parks	\$16,673,020	\$15,692,181	\$980,839
Sheriff Coroner	\$93,798,764	\$98,528,878	\$(4,730,114)
Social Services	\$25,726,504	\$25,236,055	\$490,449
Treasurer Tax Collector	\$2,062,948	\$1,765,652	\$297,296
Totals			\$4,430,771

bottom line. The lower expenditures are primarily due to the salary and benefit saving in the Health Department (\$18.7 million) and the Department of Social Services (\$10.2 million). Other major variances in expenses include lower program expenditures of \$9.6 million in the Health Department due to lower services to the public than planned. In the current year, departments utilized salary savings to offset wage increases resulting from classification and compensation studies and finalization of labor agreements.

Current year non-program revenue is estimated \$15.9 million higher than budget due to improvement in property taxes of \$4.0 million, \$12.2 million higher-than-budgeted Transient Occupancy Tax (TOT) revenue, and \$1.7 million higher-than-budgeted sales and use tax; offset with a reduction to cannabis tax revenue of \$2.8 million due to Board action which reduced the cannabis tax rates. Other major revenue reductions include \$14.3 million lower revenue in the Health Department due to lower than planned services and redirection of staff to pandemic response and a decrease of \$1.3 million Assessor County Clerk/Recorder due to a decrease in real estate transactions.

Forecast

The forecast reveals an estimated surplus of \$4.4 million next fiscal year and significant deficits in the upcoming two years when taking into account the estimated surplus from the current year. These deficits are projected despite the anticipated increases in non-program revenue next in the forecast years. This imbalance is the result of continuing increased costs which will exceed available funding. More details about the cost drivers creating this imbalance are provided in the cost driver section of this report.

The forecast includes preliminary GFC allocations that include \$4.6 million in cannabis revenue. This level of cannabis revenue represents a decrease of \$2.8 million from the adopted budget resulting from lower tax rates approved by the Board. Moreover, based on current revenue collection levels and potential additional changes to the cannabis taxation; it is likely cannabis revenue could be even lower than the \$4.6 million forecasted. Accordingly, no growth is anticipated to the cannabis assignment.

The forecast does not include one-time revenue such as ARPA funds. The CAO plans to bring an updated ARPA plan to the Board of Supervisors during the budget process to receive direction on priorities and funding level for FY 2023-24. However, this report does include a status of current ARPA spending. Furthermore, there are pending classification and compensation studies being performed by the Human Resources Department and the financial impact of the Winter Storm and Atmospheric River Event that have not been included in the forecast due to the timing of the event.

The three-year forecast reflects a drop in expenditures and revenue primarily due to exclusion of one-time expenses and pandemic response expenses anticipated to conclude in the current year. Furthermore, ARPA revenue utilized in the current year to backfill revenue loss is also excluded from the forecast. The forecast reflects deficits primarily driven by the rising cost of health insurance, PERS, general liability insurance, worker's compensation, and negotiated salary increases.

Departments estimate program revenues based on the programs they deliver and known federal and State funding sources as well as grants for the forecast period. Non-program revenue, which is the County's discretionary revenue, is projected to decrease with the absents of ARPA funding and then slightly improve through the forecast period. County staff are typically conservative when estimating revenues and expenditures with actual performance generally favorable compared to forecasts. These hypothetical deficits are based on current operations and policy and do not include future service enhancements, wage increases for expiring labor agreements after FY 2024-25, changes in federal or State financial commitments, or revenue declines in an economic downturn, or inflationary changes which have developed over the last few months.

Looking into the future, the County, like the State and other local governments, must continue to plan for a stable and sustainable future for coming generations by maintaining its Strategic Reserve, addressing infrastructure needs, and paying down unfunded liabilities. The financial forecast assumes that the economy continues to grow through the forecast period and does not include potential impacts that may result from possible federal or State policy changes or impacts of a recession or current year discretionary revenue declines.

While some growth is assumed in forecasted years, it is not enough to cover increases in costs for current levels of staffing and services. Furthermore, planning for service delivery in unprecedented times created by the global pandemic continues to be an issue of concern for the State as well as local governments. Any new budget commitments will increase the severity of reductions the County would have to make in an economic downturn. Given these uncertainties and events, prudent financial management practices, including limiting new on-going commitments or expansion of programs, is paramount for the current environment.

General Fund Revenues

General fund revenue is composed of program and non-program revenue. Program revenue is specifically designated and/or statutorily required for programs. Sources of program revenue are derived from State and federal aid for various mandated programs primarily in Health and Social Services, charges for services are primarily fees collected by health clinics and other revenues include primarily reimbursement from realignment funds for health, social services, and public safety programs.

Non-program or “discretionary” revenues are mostly derived from taxes and are utilized to address local priorities and to provide funds to leverage federal and State monies, including maintenance of effort requirements.

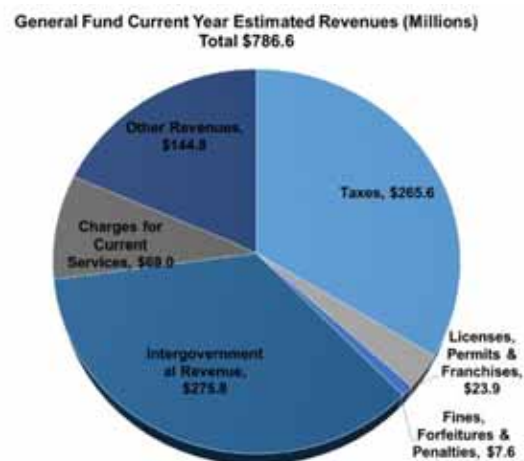

Current year revenues are \$7.5 million below budget expectations. The major variances compared to budgeted revenue in the current year include:

- **Revenue in the Health Department is \$23.5 million below budget.** The Health Department is estimating a decrease in health fees and lowered reimbursements due to a lower than anticipated level of service due to vacancies (24% vacancy rate) in revenue generating operations and redirection of staff to pandemic response.
- **Revenue in the District Attorney Office is \$2.1 million below budget.** The District Attorney’s Office is projecting a decrease in revenue of \$2.1 million as reimbursements from are delay in settlement of civil cases.
- **Revenue in the Assessor County Clerk/Recorder is \$1.5 million below Budget.** The Assessor County Clerk Recorder estimates a revenue decrease in the Recorder Division of \$1.5 million due to a decline in real estate transactions.
- **Revenue in the Treasurer Tax Collector is \$1.0 million below Budget.** The Treasurer Tax Collector

projects revenue to be \$1.0 million below budget due to lower levels of reimbursable expenditures in both the Revenue and Treasury Divisions due to the impact of Assembly Bills 177 and 199.

- **Revenue in Social Services is \$4.6 million above budget.** Social Services is estimating revenue above budget primarily due to the Emergency Rental Assistance Program (\$4.1 million) and State Project Roomkey revenue (\$500,000). Due to timing, the \$4.1 million increase in appropriations was not included in the table above for the modified budget figures for the Emergency Rental Assistance Program.
- **Non-program revenue is projected to be \$15.9 million higher than budget.** In the current year, the increase in discretionary revenue is largely driven by TOT tax which is \$12.2 million above budget and Property Tax 4.0 million above budget. The budget included assumptions that the pandemic would continue to impact TOT, but as the economy remains open, and current year revenues support a higher projection, the TOT was revised upward. Additionally, property taxes are expected to be better than budget due to continued higher property values, and sales tax is projected to be higher than initial budgeted estimates.

Forecasted years exclude one-time revenue sources and ARPA revenue, but overall, assume modest growth in program and discretionary revenues. Departments balance their budgeted expenditures based on a combination of revenues earned directly by the program (State reimbursement, permit fees, clinic charges, etc.) and County contributions of discretionary “non-program” revenue.

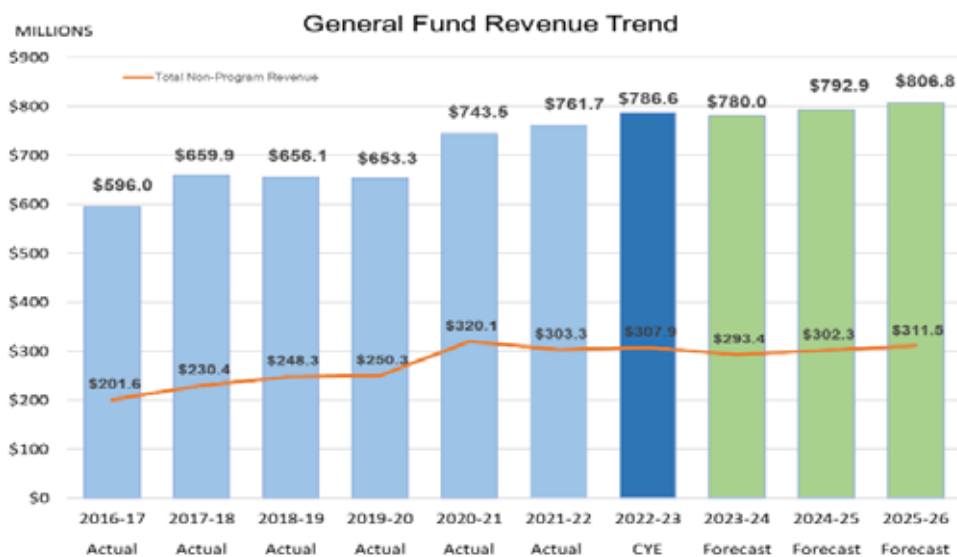

Since FY 2013-14, the County’s program revenues have mostly grown under state-county realignment and the Affordable Care Act to support increased responsibilities and associated costs, including mandated public assistance and health and public safety programs. For FY 2022-23, general fund revenues are estimated to increase over the prior year, primarily due to \$24.0 million of estimated ARPA funds for pandemic response, economic recovery, infrastructure projects, and provision for government services. The forecast period beginning with FY 2023-24 excludes any ARPA funds as the plan to use those funds is evolving in line with Board of Supervisors’ direction and funds are prioritized and approved during the annual budget process. Additionally, the forecast excludes revenue for other departmental programs that are ending such as Whole Person Care program and the Emergency Rental Assistance Program in Social Services. Beginning with FY 2023-24, general fund revenue decreases in the forecast years due to State and federal reimbursements, and an increase in non-program revenue, specifically continued growth in

property taxes, sales and use tax and TOT. The chart above reflects the overall general fund revenue trend and the non-program revenue trend, which accounts for slightly over one-third of general fund revenues.

Discretionary Revenues

Discretionary revenues provide the Board flexibility to address local priorities and to provide matching funds to leverage federal and State monies and to meet maintenance of effort requirements.

Property tax revenue account for majority of local discretionary monies. Sources of non-program revenue are displayed in the chart to the right. Total non-program revenue in the current year is estimated at \$307.9 million.

Property tax revenue is the largest source of non-program revenue, projected at \$207.0 million (67.2%) of total current year estimated non-program revenue. Other significant sources of discretionary revenue include: \$24.0 million in ARPA revenue; \$40.0 million in TOT; \$13.9 million in sales and use tax revenue; franchise fees of \$6.3 million; \$4.6 million in Cannabis revenue; and tobacco settlement monies of \$4.5 million.

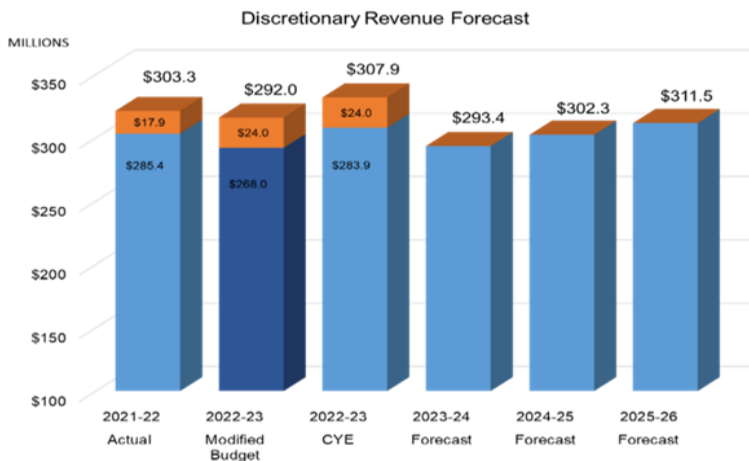
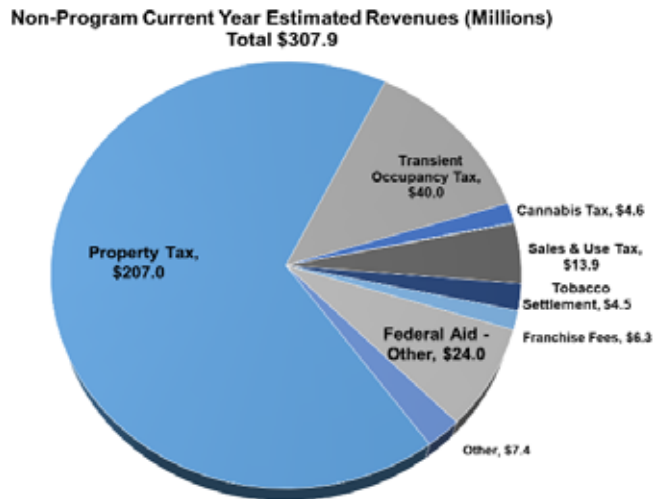

Discretionary revenue continues to grow in coming years. The chart reflects the projected non-program revenue in the current year, upcoming budget year (FY 2023-24) and two out years. Projected current year non-program revenue is above budget mostly due to improvement in TOT and property taxes as current year performance has fared better than initial more conservative estimates included in the budget. The chart also breaks out ARPA revenue from the prior year and current year, to reflect a more accurate

trend in discretionary revenues. Adjusting out the ARPA revenues from the current year, we see that discretionary revenue grows \$9.5 million in FY 2023-24 and an additional \$8.9 million and \$9.2 million in the subsequent two years, respectively. The improvement in projected revenue is primarily due to positive trends in property tax collections resulting from higher assessments and increases in TOT and sales tax as the economy continues to recover from the pandemic. These improvements in revenue are partially offset by an estimated decrease in cannabis revenue of \$2.8 million in the current year continuing into next fiscal year.

Increases in property assessments result in discretionary revenue growth. While the forecast assumes moderate growth in property tax assessment, the impact of a recession on property tax revenue should be noted. During the economic recession beginning FY 2008-09, property taxes sustained steep reductions, declining \$15.6 million from peak to trough. This impacted County services and was the driving factor behind four years of budget reductions following the onset of the recession. Assessed values have steadily recovered and since exceeded pre-recession levels.

As seen on the chart, property taxes continue to grow due to positive trends in property values and an increase in assessments. Next year, the forecast assumes a 4.5% growth resulting in a \$9.2 million improvement in property tax revenue. The two out years include a more conservative growth assumption of 3.1% and 3.2% each, yielding additional revenue of \$6.8 and \$7.0 million respectively. However, it is important to note that the pandemic may have long term effects in the economy, and along with inflation and rising interest rates, could impact property values and thus property taxes in the coming years.



Transient Occupancy Tax is improving as pandemic restrictions ease. TOT is the County’s second largest source of discretionary revenue. Often referred to as the “hotel tax,” TOT is the tax applied on hotel/motel accommodations. Various tourist attractions contribute to the County’s TOT. The tax rate for Monterey County is 10.5%. Peak TOT revenue in FY 2018-19 included revenue attributable to the U.S. Open, a one-time event, as well as continued efforts by the Treasurer-Tax Collector in recuperating one-time collections for non-complaint Short Term Rental operators.



The pandemic and corresponding stay at home orders negatively impacted revenue collected in the second half of the FY 2019-20. As travel restrictions eased in FY 2020-21, the County saw a rebound in tourism with revenues coming in at \$23.5 million. In consideration of the pandemic, TOT revenue was budgeted conservatively at \$17.7 million in FY 2021-22, however TOT revenue came in at a historic \$40.0 million. In FY 2022-23, TOT revenue is once again expected remain at the high of \$40.0 million through FY 2023-24. TOT revenue in the second and third forecasted year expected to grow by 3.9% (\$1.6 million) and 4.5% (\$1.9 million) assuming no economic downturn.

Three Year Forecast

Cannabis revenue is decreased based on recently approved tax changes.

The adopted budget included \$7.4 million, with an estimated \$6.2 million attributed to the cannabis program to support 25.23 FTEs. The remaining \$1.2 million was allocated as discretionary revenue supporting all County departments. In the current year, the Board approved reductions to cannabis tax rates resulting in estimated current year revenue of \$4.6 million, or \$2.8 million below budget. Per Board direction non-cannabis program allocations and Health intervention program were to be funded with Cannabis Tax Assignment for February 1 to June 30, 2023.

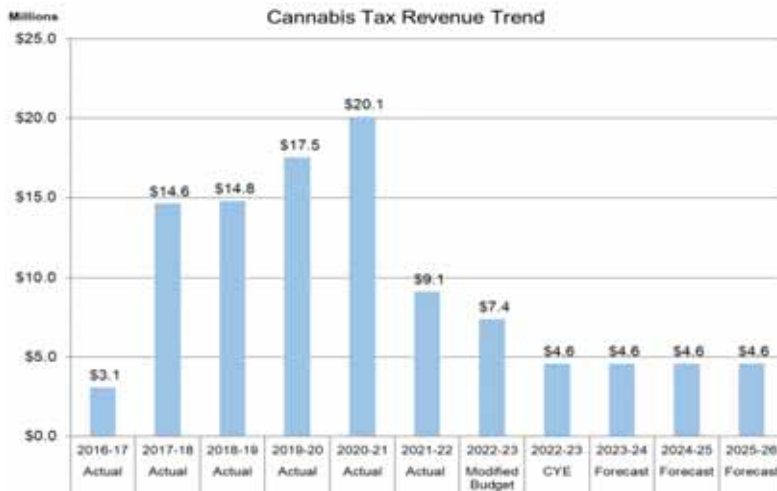

If lower cannabis tax rates are adopted by the Board of Supervisor as cost pressures continue in the industry, in FY 2023-24 cannabis revenue will further decrease and the cannabis program will be further affected.

As of the date of this report, the cannabis assignment has an estimated uncommitted balance of \$4.1 million. The assignment is not expected to grow at the end of the current or future years since cannabis revenue is allocated entirely as part of the GFC next fiscal year. Assignment utilization in FY 2022-23 totals \$10.2 million as shown in the table below.

Cannabis Approved Assignment Uses FY 2022-23		
Description	FY 2022-23	
Assignment Use	\$ 10,232,045	
Famworker Resource Center (Health Department)	\$	250,000
Local Housing Trust Fund Program(HCD)	\$	600,000
Assigned as Fund Source in FY 2023 Adopted Budget	\$	6,575,741
Costs Related to Settlement and Close Out of Jail House Addition Project	\$	977,006
Alisal Vibrancy Plan Implementation (PWFP)	\$	50,000
Pajaro Sanitation District Operating & Capital Costs (PCSD)	\$	1,320,603
Cannabis: Youth Prevention/Interventio and Public Awareness (Health)	\$	93,000
Non-Cannabis : Various Departmental Allocations	\$	365,695
Grand Total	\$ 10,232,045	

General Fund Expenditures

The FY 2022-23 adopted budget included appropriations of \$851.1 million. The modified budget is \$854.4 million. Changes primarily include an amendment of \$2.0 million settlement and closeout of Jail Housing Addition Project and \$1.3 million for Pajaro County Sanitation District capital costs were funded with fund balance. There are modifications to budgets which occurred after this report was compiled and were not included in the modified budget figures due to timing. Departments continue to amend their budget throughout the year as the need arises and the final modified budget will be different.

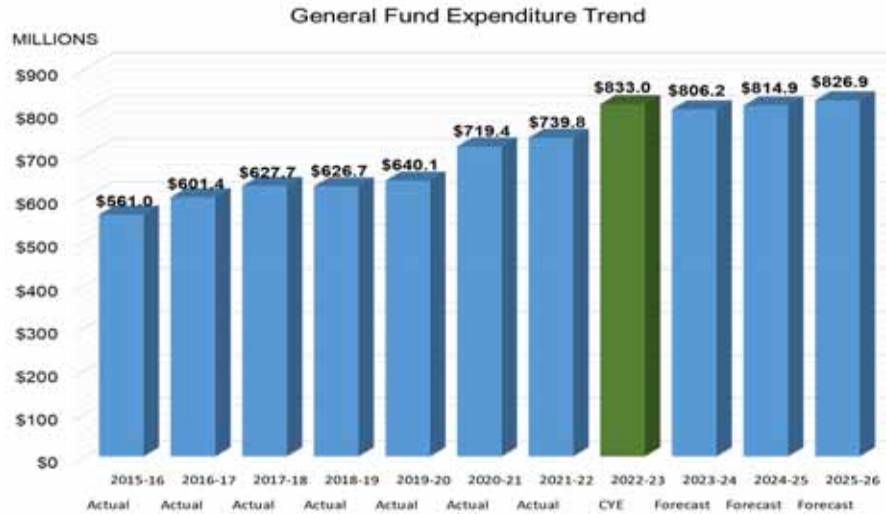

Current year expenditures are estimated at \$833.0 million, or 14.5 million below budgeted expenditures.

The primary factor for below budget expenditures in the current year is \$37.3 million in salary and benefits savings from vacancies across the County. The Health Department alone accounts for \$18.7 million in salary and benefit savings and the Department of Social Service \$10.2 million as the departments continue to struggle recruit and to find qualified staff.

At the writing of this report, the County had an overall 17.2% vacancy rate in the general fund. For perspective, the 2.0% increase that most units in the County received and the wage adjustments had an estimated cost \$17.4 million in the current year, based on currently filled positions. At the time the forecast was developed there were an estimated 606 vacancies in the general fund, with an estimated annualized value of \$52.4 million next fiscal year. Of these vacancies, approximately 56% reside within two departments: Health and Social Services. To the extent these departments fill vacant positions costs will go up, but it is likely some of the costs would qualify for some level of reimbursements from State and federal agencies. Therefore, vacancies in these departments do not translate into County savings to the same extent than departments which cannot seek reimbursement from State and federal agencies for costs not incurred. The same holds true for departments with grant-funded vacancies or departments that share cost with other payors.

For next year’s forecast, one-time expenditures such as infrastructure projects and pandemic related programs such as the rental assistance program are excluded. In the forecast, departments generally assume that all vacancies are filled and at top step. This conservative estimate illustrates potential increases in expenditure levels; however, expenditures are curtailed to available funding. As responsible fiscal managers, Departments make operational changes if funding levels are constrained, including delaying hiring of vacant positions. An adjustment for salary savings is made in the forecast years. This adjustment is discussed later in the report.

One-time expenditures in the current year are financed with fund balance. The FY 2022-23 adopted budget included \$34.0 million use of fund balance to cover one-time expenditures. One-time funding of \$23.0 million of ARPA funds were allocated throughout general fund departments to eliviate revenue loss and continue with COVID-19 respond efforts. Cannabis Assignment of \$3.1 million was allocated for numerous one-uses for such items as the Gonzales Community Center, the Climate Action Plan, the Salinas Soccer Complex and Playground Inspection, Equipment and Maintenance. Remaining fund

balance use includes \$7.9 million of departmental restricted fund balance use for health, social services and public safety programs.

ARPA- COVID -19 Pandemic Aid

In March 2021, the federal government enacted the American Rescue Plan (ARPA) which provides \$350.0 billion in emergency funding for state, local, territorial, Tribal governments to respond to the COVID-19 public health emergency, or its negative economic impacts, including providing assistance to households, small businesses, and nonprofits, or aid to impacted industries, such as tourism, travel, and hospitality. The County was allocated \$84.3 million, paid in two installments over the past two years (2021 and 2022). The Board’s spending plan allocated the ARPA funds over four fiscal years. The County must utilize or obligate the ARPA funds by December 31,2024.

Monterey County ARPA Plan Expenditure Summary						
Updated January 2023						
General Fund						
Department	Spent		Allocated	Allocated	Allocated	Total Allocated
	FY 2020-21	FY 2021-22	FY 2022-23	FY 2023-24	FY 2024-25	All Years
Ag Commissioner	\$ -	\$ 222,353	\$ -			\$ 222,353
Auditor Controller	\$ -	\$ 167,200	\$ 356,590			\$ 523,790
Board of Supervisors	\$ -	\$ -	\$ 234,506			\$ 234,506
Civil Rights	\$ -	\$ 50,799	\$ 204,767			\$ 255,566
Clerk of the Board	\$ -	\$ -	\$ 102,727			\$ 102,727
County Administrative Office	\$ 4,989,651	\$ 2,669,030	\$ 5,368,762			\$ 13,027,443
County Administrative Office EOC	\$ 747,169	\$ (747,169)	\$ -			\$ -
County Counsel	\$ -	\$ 107,494	\$ 517,710			\$ 625,204
District Attorney	\$ -	\$ 237,000	\$ 1,687,964			\$ 1,924,964
Health	\$ 2,045,677	\$ 6,329,477	\$ 3,472,373	\$ 318,194	\$ 77,973	\$ 12,243,694
Housing and Community Development	\$ -	\$ 934,112	\$ 520,000			\$ 1,454,112
Human Resources	\$ -	\$ 349,545	\$ 652,659			\$ 1,002,204
Information Technology	\$ -	\$ -	\$ 3,281,482			\$ 3,281,482
Probation	\$ -	\$ 371,012	\$ 12,560			\$ 383,572
Public Defender	\$ -	\$ 504,002	\$ 559,549			\$ 1,063,551
Public Works Facilities and Parks	\$ 424,720	\$ 3,400,726	\$ 1,414,394	\$ -		\$ 5,239,841
Sheriff Coroner	\$ 504,038	\$ 2,906,798	\$ 3,812,723			\$ 7,223,559
Social Services	\$ 256,989	\$ 223,822	\$ 2,062,293			\$ 2,543,104
Treasurer Tax Collector	\$ -	\$ 61,810	\$ -			\$ 61,810
FY 2023-24 Revenue Loss				\$ 14,286,196		\$ 14,286,196
Totals General Fund	\$ 8,968,245	\$ 17,788,011	\$ 24,261,059	\$ 14,604,390	\$ 77,973	\$ 65,699,678
Other Funds						
	Spent		Allocated	Allocated	Allocated	Total Allocated
	FY 2020-21	FY 2021-22	FY 2022-23	FY 2023-24	FY 2024-25	All Years
Emergency Communications	\$ -	\$ 278,046				\$ 278,046
Public Works - Road Fund	\$ -	\$ 110,000				\$ 110,000
Public Works - Boronda CSD	\$ -	\$ 38,993				\$ 38,993
Public Works - San Jerardo CSD	\$ -	\$ 35,159				\$ 35,159
Public Works - Pajaro CSD	\$ -	\$ -	\$ 1,178,797			\$ 1,178,797
Public Works - Capital Projects	\$ -	\$ 1,751,986	\$ 13,952,312	\$ 375,524		\$ 16,079,822
Workforce Development Board Fund	\$ 745,342	\$ 145,425	\$ -			\$ 890,766
Totals Other Funds	\$ 745,342	\$ 2,359,609	\$ 15,131,109	\$ 375,524	\$ -	\$ 18,611,583
Grand Total Obligated County	\$ 9,713,586	\$ 20,147,619	\$ 39,392,168	\$ 14,979,914	\$ 77,973	\$ 84,311,261
Federal Allocation						\$ 84,311,261
Unallocated						\$ (0)

The table above represents the updated ARPA Plan as of January 2023. In FY 2020-21 a total of \$9.7 million was spent with the expenditures occurring in the general fund (\$8.9 million) and other funds (\$745,342). At the end of FY 2021-22, the general fund had expended \$17.8 million while other funds spent \$2.4 million for a total of \$20.1 million. In the current fiscal year, a total of \$39.4 million has been allocated to be used in the general fund (\$24.2 million) and other funds (\$15.1 million). In FY 2023-24, a total for \$14.9 million are set aside; of this amount \$14.3 million is set aside in the general fund in the

revenue loss category to be used as part of the budget process. The remaining amount has already been allocated by the Board for a specific purpose; \$375,524 for capital projects and \$318,194 for violence prevention programs. The CAO budget office recommends that any funding needs requesting ARPA as the financing source are considered by the Board as part of the budget process. This would enable the Board to make funding decisions based on a comprehensive view of the overall County’ needs.

Major Cost Drivers

County programs and services continue to be impacted by higher labor costs resulting from negotiated salary increases, increased employer pension contributions, increased healthcare costs, higher workers’ compensation, and general liability costs.

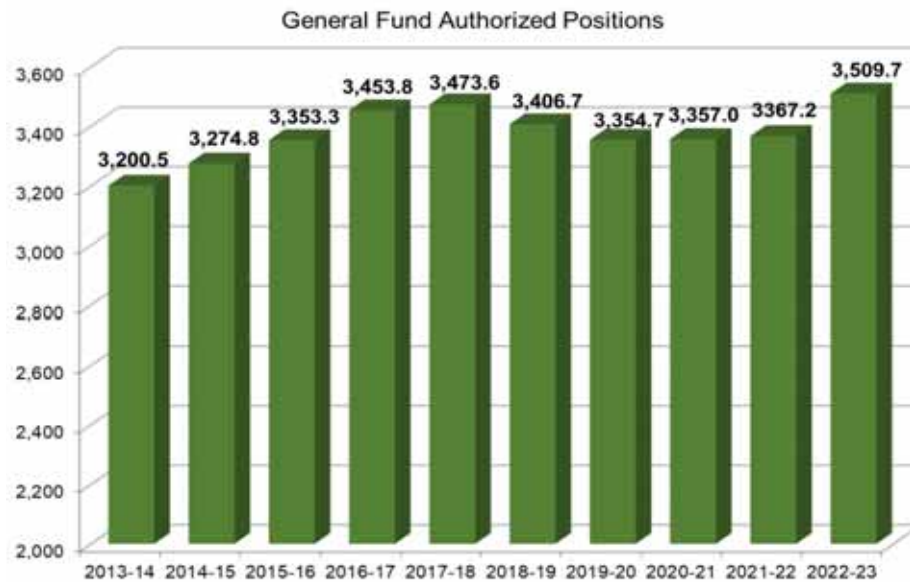

Three Year Forecast

Prior and current fiscal year wage increases add to salary cost. In July 2021 and October 2021, the Board of Supervisors approved wage increases for FY 2021-22 through FY 2023-24. The Board approved wage increases for most labor groups of 2.0% through FY 2022-24, while SEIU represented units received 2.0% in the FY 2021-22 and 2.5% in the subsequent two years. Additionally, the County has implemented wage adjustments for various classifications throughout the County resulting in increased costs to the County. These adjustments originated from compensation studies conducted by Human Resources in accordance with the County’s compensation philosophy. Independent of position growth, wage increases approved for the three fiscal years had an estimated impact of \$17.4 million in cost (wages and impact to payroll taxes and higher pension contributions) to the general fund in the current year, compounded to \$22.5 million by the end of the third year annually. The forecast assumes approved wage increases through FY 2023-24.

Along with increases in staffing levels, salary increases continue to constrain department’s budgetary flexibility. Between FY 2012-13 and FY 2017-18, general fund positions increased year-over-year, with a total of 427.1 general fund positions added. However, FY 2018-19 was the first-year general fund positions experienced an overall drop. Although it appears FY 2019-20 positions decreased, this was due to the move of Emergency Communications out of general fund (75 positions). In FY 2020-21, FY 2021-22 and FY 2022-23 additional positions were added.



Departments estimate salary expenditures increase \$14.8 million, from \$272.9 million in the prior year to \$287.7 million in the current year. The estimate includes higher wages based on labor agreements, plans to fill additional positions through the current year, and step advances. As mentioned earlier in the report, departments generally forecast all vacancies are filled and at top step. Departments manage their budgets to anticipated funding levels, and thereby make changes to their operations – including delaying hiring. Additionally, savings in salaries have consistently occurred due to attrition and turnover. Some Departments such as Health and Social Services build in a vacancy rate into the forecast. However, it is important to note that most departments experience turnover and attrition, and actual performance is historically better than the projections. As such, the forecast added a salary savings adjustment to illustrate prior years’ experience more closely in salary expenditures. Taking the salary adjustment into consideration, salary expenditures increase to \$313.6 million by FY 2025-26. The forecast includes future wage increases for labor agreements through FY 2024-25; the last year of the forecast period does not include wage increases as labor agreements are set to expire by FY 2024-25.

Employer contributions continue to increase. The County continues to see its contributions towards employee pensions increase. Driving the increases are changes to CalPERS’ actuarial methodology, including the following actions:

- Changes in amortization and rate smoothing policies to accelerate paying down large unfunded liabilities.
- Change to fixed dollar contribution for the unfunded liability portion, rather than as a percentage of payroll, to prevent potential funding issues that could arise from a declining payroll.
- Adoption of new demographic assumptions that show retirees living longer, and thus requiring higher lifetime payout of benefits.
- Approval of a new funding risk mitigation policy to incrementally lower the discount rate.

Projected results assume no plan changes, no changes in assumptions, and no liability gains or losses. Additionally, projected results are based on investment returns not falling below the assumed rate of return, which will increase contributions. Projections are also based on payroll reported to CalPERS and assume an inflation factor; however, projections do not consider adding new positions. Any changes to those elements will have a direct impact on required contributions.

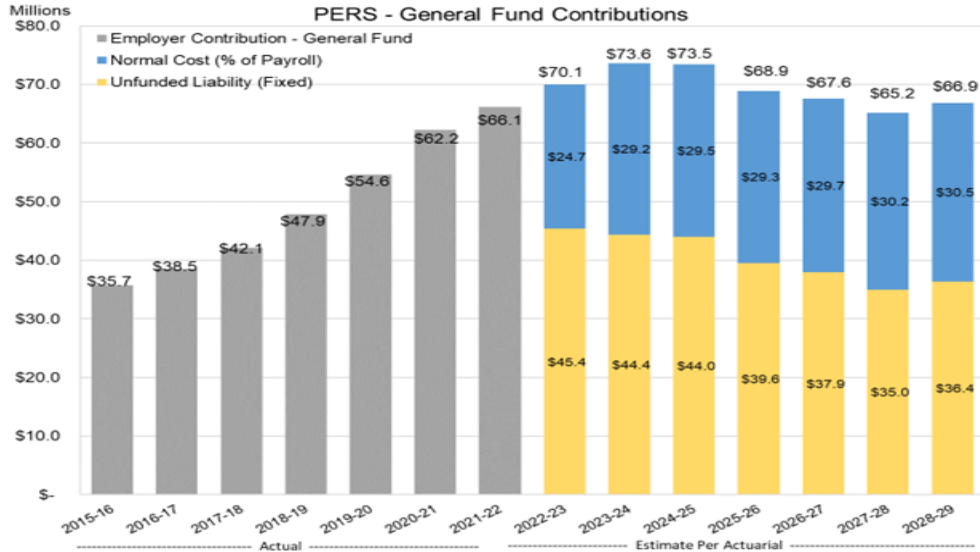

General fund contributions continue to increase in the forecast years with an increase of \$3.5 million next fiscal year bringing the total contribution to \$73.6 million, which is double the FY 2015-16 contribution. The most significant change impacting contributions is the reduction in the “Discount Rate,” which reduced the assumed rate of return by CalPERS from 7.50% to 7.0% over three years, beginning with the June 30, 2016 valuation, which set FY 2018-19 contributions. Additionally, there was a shift to charge unfunded accrued liability (UAL) payment as a fixed dollar amount rather than a percent of payroll to prevent funding issues. With these changes, there was a five-year ramp up period where contributions were accelerated to pay down liabilities; however, the full impact of increases to UAL payments was anticipated to be seven years, through FY 2024-25, due to the phase in period of the discount rate and then UAL payments were anticipated to level off.

The projections reflect lower increases after FY 2024-25. However, CalPERS has announced that as part of their Funding Mitigation Policy, the discount rate will be further reduced to 6.8% effective with the June 30, 2021 valuation. Their policy seeks to reduce funding risk over time and establishes a mechanism that prompts adjustments if the investment performance significantly outperforms the discount rate, expected investment returns, and strategic asset allocation targets. This was the case for FY 2020-21, where performance yielded a 21.3% return on investment, and therefore, a 20-basis point adjustment was triggered by the funding policy. In FY 2021-22, the performance yielded a -6.1% return on investment leading to the first loss since the 2009 financial crisis. As a result, employer contributions are expected to increase in the coming years.

The changes to CalPERS funding policy have resulted in increasing contributions for the County, consuming a larger share of revenue every year. The contributions for FY 2022-23 and through the forecast years are based on a 7.0% discount rate. The projections in the chart above are based on CalPERS actuarial valuations, which are built on actual payroll data obtained by CalPERS, and therefore, based on existing levels of filled staffing. The chart breaks out the portion of the contribution that goes toward paying unfunded liabilities. While the “normal” cost has stabilized at about \$29.0 million for the next seven fiscal years, the unfunded liabilities payment is what drives the increases over the next seven years. The County’s current unfunded liabilities of \$505.7 million (all funds).

In order to help reduce the County’s unfunded liability, the Board of Supervisors adopted a pension liability policy during FY 2020-21 and the County established an IRS Section 115 pension trust. The trust

serves as an investment vehicle outside of the County’s Treasury Pool to generate investment proceeds to address future pension liability obligations. This is important progress toward planning for the future and managing growing unfunded liabilities. Trust assets may be used for contributions and / or supplemental payments to unfunded liabilities. In the long term, this reduces reliance on discretionary revenues to meet this obligation and prepares the County for hard economic times potentially averting reductions of critical programs. Initially, the County used onetime funds to establish the pension trust, this includes a \$3.5million from Natividad. Additionally, in FY 2022-23, a \$250,000 appropriation and revenue increase were approved by the Board to finance the independent administrator expenses to manage the County’s investment was approved by the Board from funded by the surplus of FY 2021-22.

In addition to the one-time contributions, beginning with FY 2022-23 the County implemented a supplemental pension contribution plan to continue the progress toward paying down future unfunded liabilities. This plan allows for continuous investments as opposed to only contributing surpluses or one-time funds. In FY 2022-23 the total allocations for this plan are \$10.5 million in the general fund (\$15.4 million all funds). In FY 2023-24, allocations will be \$11.0 million. This pension charge intends to capture County and non-County funding sources to share in the growing UAL costs created in prior years as it is anticipated that some departments will recover a portion of these costs from non-County sources. It is important to note that although the County has taken various actions to address the unfunded liability and forecasted years show lower contributions, they will not revert to those of FY 2015-16.

Increases in health insurance premiums continue to add to Countywide fiscal pressures.

Health care costs for the current year are estimated at \$64.7 million, an increase of \$5.8 million from the prior year. This increase is a direct result of premium increases and the terms of the latest negotiated labor contracts which include higher County contributions for premiums and higher costs of flex cash credits provided to more bargaining groups. As comparison, costs increased \$6.0 million from FY 2015-16 to FY

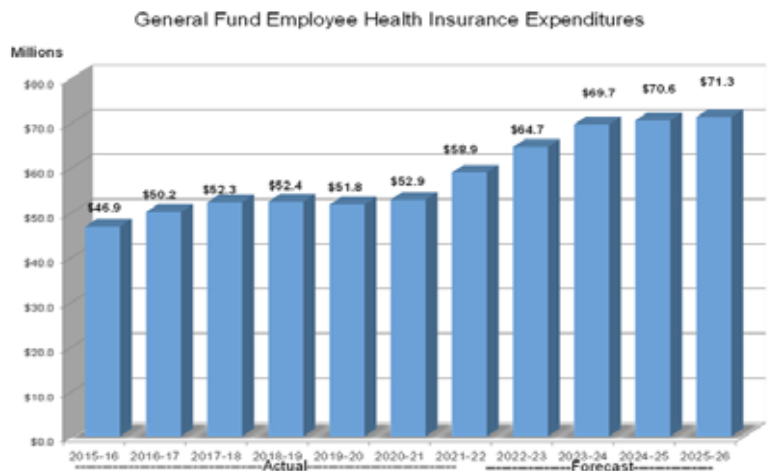

2021-22. Additionally, costs are estimated to grow by \$5.0 million in FY 2023-24 a significant increase with premium increasing for PERS Gold by 17.79% and PERS Platinum PPO by 14.48%. However, much of the increase is tied to assumptions that vacancies are filled. After that significant increase, costs are expected to remain fairly stable in the last two years of the forecast (FY 2024-25 and FY 2025-26).

Costs to run internal service fund programs continue to increase.

The workers’ compensation program continues its trend of increasing projected allocated costs. FY 2023-24 costs are estimated at \$20.8 million or \$1.9 million higher than the current year and projected to grow 10% annually in the following two years, to \$22.8 million by FY 2025-26. This growth represents a \$11.2 million increase from FY 2015-16 costs. Next fiscal year, the general liability (GL) program’s allocated costs to departments also are estimated slightly lower than the current year at \$12.8 million (recoverable and non-recoverable combined) and then grow 15% in the subsequent two years to \$16.6 million by FY 2025-26. Costs for this program were \$7.1 million in FY 2015-16, resulting in a growth of \$9.5 million by the end of the forecast period.



The chart above, shows the trend of historical and projected workers’ compensation and general liability costs. The chart reflects a dip in FY 2020-21 for general liability costs, which reflects the suspension of approximately \$8.5 million in charges of GL recoverable costs to general fund departments due to budgetary constraints. In FY 2021-22, the GL recoverable costs resumed.

Funding Commitments

In addition to operational cost drivers, County policy provides for funding towards external agencies and to the Road Fund. Funding agreements are based on percentage formulas, which have generally resulted in increased annual contributions in recent years. These commitments total \$13.4 million in FY 2022-23 and result from the following:

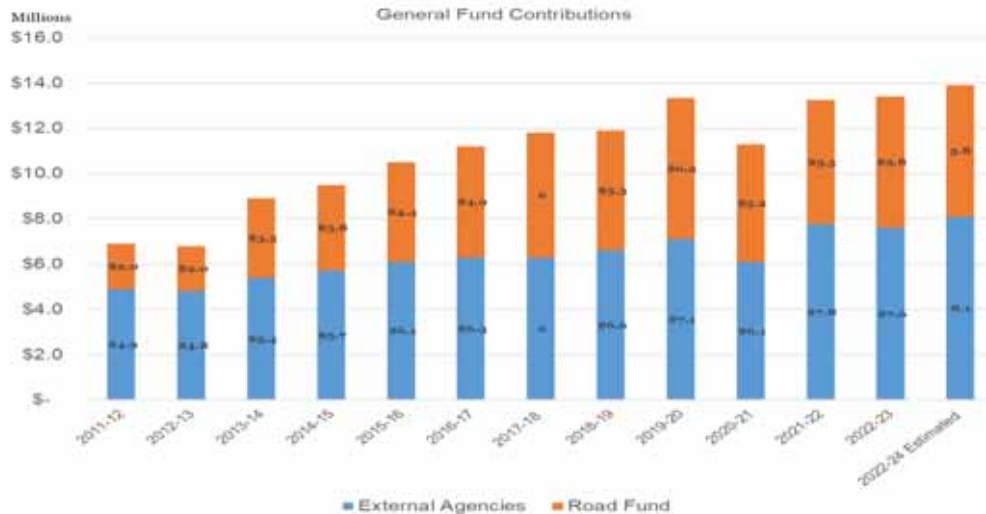

- Funding to external agencies in support of their mission to economic development.** County policy provides funding for agencies that promote economic development, tourism, and cultural arts. Contributions to these endeavors has varied over time as the County’s contribution adapts to the economic conditions facing the community. For example, during FY’s 2016-17 and 2017-18,

contribution amounts were capped at FY 2015-16 levels, or \$1.9 million, due to fiscal constraints. In FY 2018-19, contributions returned to formula based; however, in FY 2019-20 contributions were again capped and include \$2.1 million from TOT. In FY 2020-21, the contribution was based on a formula driven approach amount but with a cap reflecting the anticipated decline of TOT revenue resulting in a contribution of \$1.2 million. In FY 2021-22, the amount was based on a formula using FY 2018-19 (pre pandemic) revenue, resulting in a contribution of \$2.5 million. On April 26, 2022, the Board of Supervisors established that moving forward contributions would no longer be based on a formula, but rather capped at the FY 2019-20 amount of \$2.1 million. The forecast assumes static amounts from the current year. Contributions to these agencies had grown \$1.2 million annually over the last nine fiscal years but decrease in the current year by \$532,684. During the budget development, the Board decides the level of contributions and can modify distribution percentages for this funding based on current economic conditions.

- Proposition 172 revenues (Half-Cent Public Safety Tax).** The County distributes Proposition 172 revenues based on funding agreements to user agencies of the 911 dispatch center and to fire districts to promote public safety. These contributions are at the discretion of the Board. The FY 2022-23 contributions to user agencies of the 911 center total \$1.9 million and the allocation to the fire districts is \$3.5 million and were based on the original formula using FY 2020-21 actuals as the base. Contributions to user agencies and fire districts have grown \$575,676 and \$1.1 million annually over the last nine fiscal years. Due to a favorable Proposition 172 revenue trend the assumes a growth in contributions from the current year.
- TOT to the Road Fund.** In FY 2013-14, the Board adopted a policy to contribute a percentage of TOT revenue to the Road Fund, recognizing that well maintained roads are vital to the local economy. In FY 2019-20, the Board approved adjusting the contribution to the Road Fund at a level necessary to meet maintenance of effort (MOE) with the difference directed to Board approved road projects. In FY 2022-23 the amount was kept at the minimum MOE required. Based on current formulas, next fiscal year, the estimated contribution to the Road Fund to meet MOE is \$5.8million.

Emerging Countywide Needs

The following table summarizes emerging needs including departmental cost pressures that will require budget solutions beginning in the current year and next fiscal year. The main cost pressure in the current year is the impact of approved labor agreements, as department budgets did not include assumptions of increased wages when they developed their FY 2022-23 budgets because labor negotiations were ongoing. Although most departments are anticipating absorbing the additional cost, some departments may require budgetary solutions in the current year.

Emerging Needs - General Fund	FY 2022-23	FY 2023-24	FY 2024-25
Wage study adjustments	\$3,089,163	TBD	TBD
Salary Increases, Labor Agreements*	\$17,356,062	\$22,541,919	\$50,368,602
PERS Contribution Increase	\$3,886,936	\$3,627,166	TBD
Pandemic Response Costs	TBD	TBD	TBD
Winter Storm & Atmospheric River Event	TBD	TBD	TBD
Total	\$24,332,161	\$26,169,085	\$50,368,602

* Does not include recent increases for X, ZX, Y or K units

Salary increases. Most bargaining units finalized labor agreements with the County in the current year, resulting in additional costs of \$17.4 million. Additionally, several wage studies for various classifications occurred in the current year, with an estimated cost of \$3.1 million for the current year. The figures reflected for FY 2022-23 and FY 2023-24, do not include additional wage studies in progress, or the wage increases units that are still finalizing negotiations. Since these costs were not built into the current year budget, next year’s cost will result in a compounded amount of \$17.4 million. While non-program revenue is increasing, it is not sufficient to keep pace with increasing costs, resulting in some unfunded needs next fiscal year.

Supplemental pension charge. The County will continue to charge departments to save for supplemental pension contributions to invest funds for future pension obligations. It is essential to establish a diligent plan to address growing unfunded pension liabilities to safeguard the County’s operations in future years, as these unfunded liabilities pose a significant risk to operations if not addressed. The current UAL balance as of the writing of this report is \$568.1 million.

PERS contribution. As mentioned earlier in the report, pension contributions continue to increase. An increase of \$3.5 million is anticipated next fiscal years. This is independent of position growth or salary increases.

Pandemic Response. Impact to County operations will likely continue into FY 2023-24. Specific impacts will be estimated during the budget preparation cycle. Additionally, the County will allocate ARPA funds which can be utilized to offset the costs related to pandemic response. The evolution of the pandemic will continue to be monitored so that early action could be taken once specific impacts are identified.

Winter Storm and Atmospheric River Event. The storm and atmospheric river event required the activation of the Emergency Operations Center for the County to its highest level with staff from County departments, other cities, state agencies and disaster assistance organizations participating on a 24 hour in-person basis. As of the writing of this report, labor/staffing and services and supplies were calculated at a total of \$35.6 million. In addition, 128 capital projects have been identified with a cost of \$24.5 million. The total impact and cost to the County is unknown currently, but it is important to note that staff is seeking FEMA reimbursements.

Financial Reserves

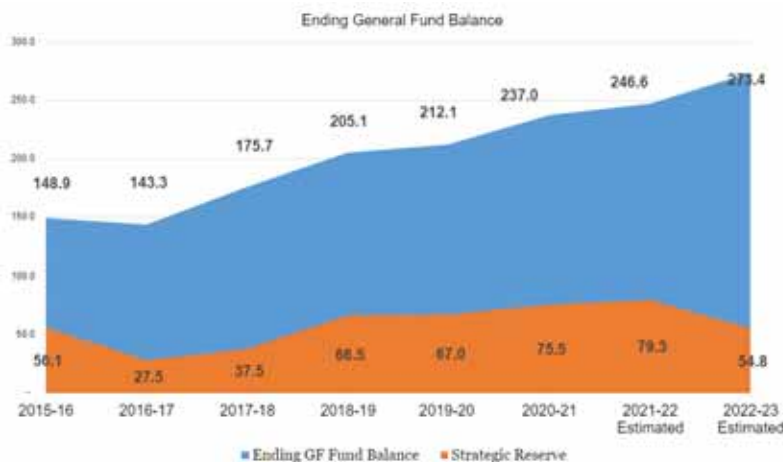

Since the recession, the Board has strengthened financial policies to restore balance between ongoing revenues and expenditures, ending the practice of using one-time gains in fund balance to finance ongoing operations. Historically, the County has invested year-end surpluses and one-time gains in its strategic

reserve and other key investments, resulting in improvement to the County’s ending fund balance each year.

The FY 2022-23 modified budget includes \$70.1 million in use of fund balance including funds authorized from restricted fund balance and other assignments. The current year estimate reflects an improvement of \$26.8 million to fund balance, primarily due to positive non-program revenue results. Based on the current year estimated results, the estimated general fund balance is projected at \$273.4 million at year-end. At the time this report was written, the Annual Comprehensive Financial Report (ACFR) was not available; therefore, fund balance figures for FY 2021-22 are estimated.

The County has previously built up the general fund strategic reserve which allowed the County to be able to respond to natural disasters and extraordinary legal costs during FY 2016-17 by redirecting \$30.9 million towards these unforeseen costs. Because of favorable results in the last four years, the County was able to keep investing in the Strategic Reserve reaching 10% of estimated annual general fund revenues, thereby meeting the Board’s strategic reserve policy ceiling. The current Strategic Reserve is \$54.8 million a decrease of \$24.6 million due to the Winter Storm and Atmospheric River event advanced funding approved by the Board for FY 2022-23 (\$23.8) million and FY 2023-24 (\$800,000).

Advanced Funding	FY 2022-23	FY 2023-24	Total
Roads and Bridges	\$ 11,505,000	\$ 800,000	\$ 12,305,000
Laguna Seca	\$ 450,000		\$ 450,000
Lake Nacimiento	\$ 203,000		\$ 203,000
County Service Areas	\$ 1,267,000		\$ 1,267,000
County Sanitation Districts	\$ 179,000		\$ 179,000
County Facilities/ Parks	\$ 348,475		\$ 348,475
Water Resources	\$ 7,000,000		\$ 7,000,000
Laguna Seca Pending FEMA Review	\$ 2,800,000		\$ 2,800,000
Grand Total Advanced Funding	\$ 23,752,475	\$ 800,000	\$ 24,552,475

As illustrated in the above graph, unforeseen costs can easily reduce reserve levels. Without the prior investments, the County may not have been able to respond to the magnitude of costs due to unforeseen events or the recession during FY 2008-09. Potential uses of the strategic reserve will help the County mitigate impacts during an economic recession or other extraordinary events. It is important to continue to preserve the County’s finances, and align expenditures to available ongoing revenues, to be better prepared for future events including an economic downturn.

General Fund Departmental Forecasts

This section provides individual departmental forecasts, which compare forecasted needs (i.e., expenditures) based on current staffing and services to available financing including estimated program revenue plus authorized general fund contributions adopted by the Board. The resulting forecast summaries help identify potential areas where service capacity may be impacted because of projected changes in expenditures and revenues. Departmental summaries offer a tool to assist the Board of Supervisors in prioritizing the distribution of discretionary general fund contributions in the upcoming budget process.

Per County policy, Departments forecasting current year deficits are required to prepare and submit a Budget Committee report outlining the cause of the problem, the alternatives available to mitigate the

projected deficit, and the Department’s recommended action. In the current year, Departments estimating a deficit include Assessor County Clerk/Recorder, District Attorney, and the Sheriff’s Office.

General Fund Contributions

Departments are provided preliminary estimates of general fund contributions for purposes of building their initial “baseline” budgets. The initial GFC estimates represent preliminary allocations of discretionary general fund monies to be used for planning purposes. Departments use these monies to supplement program-specific revenues to finance operations. All non-program revenue, including growth, was allocated as GFC to departments.

Preliminary GFC planning estimates for the budget year and forecast years were based on current year GFC allocations with the following adjustments:

- Worker’s Compensation & General Liability Increase Adjustments
- Cost Plan Adjustment – preliminary GFC planning estimates did not include an adjustment to departments GFC for anticipated cost plan charges or credits. Departments assumed static cost plan charges and credits for the forecast. Since the preliminary GFC estimates were distributed, the Auditor-Controller’s Office has published updated countywide cost plan allocation (COWCAP) amounts to be applied next fiscal year. An updated GFC estimate was distributed to departments to include an adjustment for COWCAP. Per the Board’s prior direction, updated GFC estimates redistributed preliminary GFC allocations across general fund departments to make the updated COWCAP a budget-neutral event (to the extent of available resources) and minimize the COWCAP’s impact to general fund departments.

Departmental Forecasts

Departmental forecasts assume the budget year 2022-23 preliminary General Fund Contribution (GFC) figures as approved by the Board to fund levels of staffing and services as prioritized in the adopted budget; and assumes growth in discretionary revenue in the FY 2023-24 is distributed using the same priorities. GFC for the remaining forecast years is assumed to be static from FY 2023-24. The forecast tables in the upcoming sections reference the Countywide Cost Allocation Plan as COWCAP. This represents the cost allocation plan charges or credits for departments receiving or providing internal administrative services respectively.

Agricultural Commissioner	Modified Budget 2022-23	Year-End Estimate 2022-23	Forecast		
			2023-24	2024-25	2025-26
A. Operational Expenditures	\$11,814,699	\$11,589,491	\$12,841,540	\$13,138,077	\$13,477,395
B. COWCAP	1,223,601	1,223,601	1,223,601	1,223,601	1,223,601
C. Total Expenditures	13,038,300	12,813,092	14,065,141	14,361,678	14,700,996
D. Revenue	8,322,600	8,387,500	8,468,100	8,616,100	8,767,600
E. Financing Need, C-D	4,715,700	4,425,592	5,597,041	5,745,578	5,933,396
F. Preliminary GFC	4,715,700	4,715,700	4,787,918	4,787,918	4,787,918
G. Surplus/(Deficit), F-E	\$ -	\$ 290,108	\$ (809,123)	\$ (957,660)	\$ (1,145,478)

Agricultural Commissioner – The Agricultural Commissioner’s Office expects to end the current year with \$12.8 million in expenditures, \$8.4 million in revenues and a GFC of \$4.7 million resulting in a year-end surplus of \$290,108. The surplus is primarily due to salary savings resulting from vacant positions.

The department plans to fill the openings within the fiscal year. In the forecast years, the projected expenses increase due to higher salary and benefit costs, an increase in non-recoverable liability insurance and scheduled equipment and vehicle replacement. Departmental revenues are primarily derived from unclaimed gas tax revenue and Mill tax revenue by meeting the state’s maintenance of effort. Although these revenues increase in the forecast years, their growth is not sufficient to keep up with rising expenses, resulting in projected deficits.

Auditor-Controller	Modified Budget 2022-23	Year-End Estimate 2022-23	Forecast		
			2023-24	2024-25	2025-26
A. Operational Expenditures	\$ 7,694,819	\$ 7,379,413	\$ 8,257,108	\$ 8,431,296	\$ 8,529,221
B. COWCAP	(5,787,150)	(5,787,150)	(5,787,150)	(5,787,150)	(5,787,150)
C. Total Expenditures	1,907,669	1,592,263	2,469,958	2,644,146	2,742,071
D. Revenue	593,371	607,845	593,371	593,371	593,371
E. Financing Need, C-D	1,314,298	984,418	1,876,587	2,050,775	2,148,700
F. Preliminary GFC	1,907,669	1,907,669	1,311,975	1,311,975	1,311,975
G. Surplus/(Deficit), F-E		\$ 923,251	\$ (564,612)	\$ (738,800)	\$ (836,725)

Auditor-Controller – The table summarizes the finances for departmental operations. The Auditor-Controller estimates ending the fiscal year with expenditures of \$7.4 million financed by \$5.8 million in cost plan credits and revenues of \$607,845, resulting in a projected surplus of \$923,251. The surplus is a result of salary and benefits savings due to vacancies. The deficits emerging in forecast years are driven by increases PERS retirement, health insurance costs and negotiated salary increases.

Assessor- Clerk/Recorder	Modified Budget 2022-23	Year-End Estimate 2022-23	Forecast		
			2023-24	2024-25	2025-26
A. Operational Expenditures	\$ 9,348,416	\$ 9,215,666	\$ 9,653,406	\$ 9,986,527	\$10,165,545
B. COWCAP	1,282,446	1,282,446	1,282,446	1,282,446	1,282,446
C. Total Expenditures	10,630,862	10,498,112	10,935,852	11,268,973	11,447,991
D. Revenue	4,958,351	3,476,500	3,916,000	4,416,000	4,716,000
E. Financing Need, C-D	5,672,511	7,021,612	7,019,852	6,852,973	6,731,991
F. Preliminary GFC	5,672,511	5,672,511	5,727,682	5,727,682	5,727,682
G. Surplus/(Deficit), F-E	\$ -	\$ (1,349,101)	\$ (1,292,170)	\$ (1,125,291)	\$ (1,004,309)

Assessor-County Clerk/Recorder – The Assessor-County Clerk/Recorder estimates year-end expenditures of \$10.5 million, and revenues of \$3.5 million resulting in an estimated deficit of \$1.3 million. This estimated deficit results from lower than budgeted revenues due to a decrease in real estate transactions in the Recorder’s office. Forecasted deficits are due to estimated step advances, negotiated salary increases, and employee benefit costs. In accordance with the county’s financial policies, the department will present a report to the budget committee during its February 2023 meeting to provide more details about the steps the department is taking to address the impacts of the estimated deficit in the current fiscal year.

Board of Supervisors	Modified Budget 2022-23	Year-End Estimate 2022-23	Forecast		
			2023-24	2024-25	2025-26
A. Operational Expenditures	\$ 3,957,734	\$ 3,854,622	\$ 4,068,368	\$ 4,156,713	\$ 4,226,354
B. COWCAP	837,597	837,597	837,597	837,597	837,597
C. Total Expenditures	4,795,331	4,692,219	4,905,965	4,994,310	5,063,951
D. Revenue	-	-	-	-	-
E. Financing Need, C-D	4,795,331	4,692,219	4,905,965	4,994,310	5,063,951
F. Preliminary GFC	4,795,331	4,795,331	4,857,377	4,857,377	4,857,377
G. Surplus/(Deficit), F-E	\$ -	\$ 103,112	\$ (48,588)	\$ (136,933)	\$ (206,574)

Board of Supervisors – The budget for the Board of Supervisors includes six general fund units, providing for each of the five districts, and a general pool that covers shared expenses not specific to any one district. The Department projects year-end expenditures of \$4.7 million compared to a budgeted GFC of \$4.8 million, resulting in a year-end estimated surplus of \$103,112. The estimated surplus is primarily due to salary savings from vacancies and decreases in various services and supplies such as travel and miscellaneous supplies. The deficits emerging in forecast years are driven by cost increases related to higher salaries and PERS.

Child Support Services	Modified Budget 2022-23	Year-End Estimate 2022-23	Forecast		
			2023-24	2024-25	2025-26
A. Operational Expenditures	\$10,947,678	\$10,602,486	\$11,207,010	\$11,327,953	\$11,583,048
B. COWCAP	699,098	699,098	699,098	699,098	699,098
C. Total Expenditures	11,646,776	11,301,584	11,906,108	12,027,051	12,282,146
D. Revenue	11,562,560	11,219,395	11,827,273	11,993,160	12,243,173
E. Financing Need, C-D	84,216	82,189	78,835	33,891	38,973
F. Preliminary GFC	84,216	84,216	-	-	-
G. Surplus/(Deficit), F-E	\$ -	\$ 2,027	\$ (78,835)	\$ (33,891)	\$ (38,973)

Child Support Services - Child Support Services is funded almost entirely through federal and state subventions for mandated services. The Department estimates year-end expenditures of \$11.3 million, revenue of \$11.2 million and GFC of \$82,189. The GFC is to cover non recoverable cost such as non-recoverable general liability and Enterprise Resource Planning (ERP) cost that are not reimbursable by the State. The Department’s expenses are \$345,192 below budget primarily due to salary savings resulting from turnover and retirements during the year.

It is projected that the Department’s funding allocations from the State Department of Child Support will continue to cover rising expenditures over the next three years. Additionally, any unused funds can be rolled over to future years, further mitigating request for GFC. Expenditures are forecasted to increase primarily due to increase in employee salary and benefits, workers compensation and PERS contributions. The projected deficit represents non-recoverable general liability and ERP cost that are not reimbursable by the State.

Civil Rights	Modified Budget 2022-23	Year-End Estimate 2022-23	Forecast		
			2023-24	2024-25	2025-26
A. Operational Expenditures	\$ 1,100,015	\$ 1,031,898	\$ 1,145,024	\$ 1,195,019	\$ 1,236,387
B. COWCAP	(718,754)	(718,754)	(718,754)	(718,754)	(718,754)
C. Total Expenditures	381,261	313,144	426,270	476,265	517,633
D. Revenue	-	-	-	-	-
E. Financing Need, C-D	381,261	313,144	426,270	476,265	517,633
F. Preliminary GFC	381,261	381,261	366,566	366,566	366,566
G. Surplus/(Deficit), F-E	\$ -	\$ 68,117	\$ (59,704)	\$ (109,699)	\$ (151,067)

Civil Rights – The Civil Rights Office estimates expenditures of \$1.0 million offset by a cost plan credit of \$718,754 and a GFC of \$381,261 for a projected year end surplus of \$68,117 attributable to a vacancy that has since been filled. However, it anticipates deficits at current level funding for forecasted years. With the reallocation of an Associate Analyst position to a Senior Analyst position, the Civil Rights Office is taking on more complex projects to meet organizational needs and state and federal requirements that will require additional staff support to meet competing deadlines. Furthermore, salary, pension and healthcare costs continue to increase, in addition to civil rights training and investigation services.

Clerk of the Board	Modified Budget 2022-23	Year-End Estimate 2022-23	Forecast		
			2023-24	2024-25	2025-26
A. Operational Expenditures	\$ 847,134	\$ 740,653	\$ 890,033	\$ 911,265	\$ 936,503
B. COWCAP	308,620	308,620	308,620	308,620	308,620
C. Total Expenditures	1,155,754	1,049,273	1,198,653	1,219,885	1,245,123
D. Revenue	20,000	10,000	20,000	20,000	20,000
E. Financing Need, C-D	1,135,754	1,039,273	1,178,653	1,199,885	1,225,123
F. Preliminary GFC	1,135,754	1,135,754	1,142,313	1,142,313	1,142,313
G. Surplus/(Deficit), F-E	\$ -	\$ 96,481	\$ (36,340)	\$ (57,572)	\$ (82,810)

Clerk of the Board – The Clerk of the Board estimates year-end expenditures of \$1.0 million and revenue of \$10,000 ending the year with a surplus of \$96,481. The surplus is mainly due to salary savings from vacancies. In forecasted years, revenues from assessment appeal applications filings are projected to remain static while expenditures are expected to continue rising due to step advances, negotiated salary increases and employee benefit costs resulting in projected deficits.

Cooperative Extension	Modified Budget 2022-23	Year-End Estimate 2022-23	Forecast		
			2023-24	2024-25	2025-26
A. Operational Expenditures	\$ 439,323	\$ 371,830	\$ 407,188	\$ 415,517	\$ 424,672
B. COWCAP	112,024	112,024	112,024	112,024	112,024
C. Total Expenditures	551,347	483,854	519,212	527,541	536,696
D. Revenue	27,575	16,645	16,315	16,418	16,532
E. Financing Need, C-D	523,772	467,209	502,897	511,123	520,164
F. Preliminary GFC	523,772	523,772	524,744	524,744	524,744
G. Surplus/(Deficit), F-E	\$ -	\$ 56,563	\$ 21,847	\$ 13,621	\$ 4,580

Cooperative Extension - Cooperative Extension estimates ending the current year with \$483,854 in expenditures, \$16,645 in revenue and a GFC of \$467,209, resulting in a surplus of \$56,563 due to savings

from a position vacancy. The Department projects a surplus in FY 2023-24, due to pro-rated GFC growth adjustment and a decrease in the actual cost of salary and benefits versus budgeted vacancies. In FY 2024-25 and FY 2025-26 the surplus continues at a diminishing rate as the cost of salaries and benefits increase due to step increases, and wage increases due to updated labor agreements and increased retirement costs.

County Administrative Office	Modified Budget 2022-23	Year-End Estimate 2022-23	Forecast		
			2023-24	2024-25	2025-26
A. Operational Expenditures	\$14,721,638	\$13,944,840	\$12,445,884	\$12,609,628	\$12,702,920
B. COWCAP	(2,985,569)	(2,985,569)	(2,985,569)	(2,985,569)	(2,985,569)
C. Total Expenditures	11,736,069	10,959,271	9,460,315	9,624,059	9,717,351
D. Revenue	2,008,254	2,019,260	1,961,559	1,961,559	1,961,559
E. Financing Need, C-D	9,727,815	8,940,011	7,498,756	7,662,500	7,755,792
F. Preliminary GFC	9,727,815	9,727,815	7,731,432	7,731,432	7,731,432
G. Surplus/(Deficit), F-E	\$ -	\$ 787,804	\$ 232,676	\$ 68,932	\$ (24,360)

County Administrative Office - The table above summarizes the finances for the County’s Administration “departmental” operations, including Administration and Finance, Budget and Analysis, Contracts/Purchasing, Intergovernmental and Legislative Affairs (IGLA), Emergency Services, Community Engagement & Strategic Advocacy, Economic Development, and Cannabis.

The Department projects year-end expenditures of \$13.9 million, financed by cost plan credits of \$2.9 million, revenues of \$2.0 million, and GFC of \$8.9 million. These projections result in a year-end estimated surplus of \$787,804. The estimated surplus is primarily due to salary savings from vacancies and decreases in various services and supplies, such as travel, mileage, property insurance, equipment rentals, and miscellaneous supplies.

The estimate does not include a budget request for \$750,000 supported by the Budget Committee in January 2023 for storm disaster response as the request had not yet been approved by the Board when this report was completed. It also assumes the ongoing response to the pandemic continues at the same level as the first six months of the fiscal year. Any drastic changes to this response will require further review of financing needs in the Emergency Operations Center. The Department is projecting a deficit in the third forecast year driven by cost increases related to higher salaries, health insurance premiums, retirement costs, and general liability insurance.

County Counsel	Modified Budget 2022-23	Year-End Estimate 2022-23	Forecast		
			2023-24	2024-25	2025-26
A. Operational Expenditures	\$ 6,082,754	\$ 5,746,906	\$ 6,187,938	\$ 6,391,925	\$ 6,509,138
B. COWCAP	(4,323,634)	(4,323,634)	(4,323,634)	(4,323,634)	(4,323,634)
C. Total Expenditures	1,759,120	1,423,272	1,864,304	2,068,291	2,185,504
D. Revenue	400,000	408,894	400,000	400,000	400,000
E. Financing Need, C-D	1,359,120	1,014,378	1,464,304	1,668,291	1,785,504
F. Preliminary GFC	1,359,120	1,359,120	1,349,770	1,349,770	1,349,770
G. Surplus/(Deficit), F-E	\$ -	\$ 344,742	\$ (114,534)	\$ (318,521)	\$ (435,734)

County Counsel - County Counsel estimates it will end the current fiscal year with \$5.7 million in expenditures, cost plan credits of \$4.3 million, revenue of \$408,894, and a GFC of \$1.0 million resulting in a surplus of \$344,742. The surplus is due to salary savings from several vacant and underfilled

Three Year Forecast

positions. The deficits emerging in forecast years are driven mainly by cost increases related to salaries at full staff levels, step increases, retirement costs, health insurance and workers' compensation costs.

District Attorney	Modified Budget 2022-23	Year-End Estimate 2022-23	Forecast		
			2023-24	2024-25	2025-26
A. Operational Expenditures	\$33,414,681	\$31,436,188	\$35,215,593	\$35,722,367	\$36,145,480
B. COWCAP	5,831,359	5,831,359	5,831,359	5,831,359	5,831,359
C. Total Expenditures	39,246,040	37,267,547	41,046,952	41,553,726	41,976,839
D. Revenue	18,157,975	16,062,049	18,567,019	19,337,832	20,119,501
E. Financing Need, C-D	21,088,065	21,205,498	22,479,933	22,215,894	21,857,338
F. Preliminary GFC	21,088,065	21,088,065	20,816,703	20,816,703	20,816,703
G. Surplus/(Deficit), F-E	\$ -	\$ (117,433)	\$ (1,663,230)	\$ (1,399,191)	\$ (1,040,635)

District Attorney – The Office of the District Attorney (DA) anticipates year-end expenditures of \$37.3 million, revenues of \$16.1 million and \$21.2 million in GFC, resulting in a year-end deficit of \$117,433. Revenues are down \$2.1 million due to delays in settlements of cases in the Civil Unit. Expenditures are lower than budgeted levels due to salary savings from vacancies throughout the year. The DA projects deficits in the forecast years primarily due to forecasted salary increases, increasing PERS retirement costs, health insurance premiums and allocated costs such as workers' compensation insurance and general liability insurance, without a commensurate increase in revenues.

Elections	Modified Budget 2022-23	Year-End Estimate 2022-23	Forecast		
			2023-24	2024-25	2025-26
A. Operational Expenditures	\$ 4,718,435	\$ 4,713,937	\$ 5,846,119	\$ 6,353,099	\$ 5,092,526
B. COWCAP	804,641	804,641	804,641	804,641	804,641
C. Total Expenditures	5,523,076	5,518,578	6,650,760	7,157,740	5,897,167
D. Revenue	1,579,168	1,580,493	748,710	2,198,710	398,710
E. Financing Need, C-D	3,943,908	3,938,085	5,902,050	4,959,030	5,498,457
F. Preliminary GFC	3,943,908	3,943,908	3,947,371	3,947,371	3,947,371
G. Surplus/(Deficit), F-E	\$ -	\$ 5,823	\$ (1,954,679)	\$ (1,011,659)	\$ (1,551,086)

Elections - The Elections Department administers all federal, state, county, and local public elections. Departmental expenditures and revenues vary based on the number and size of scheduled and unscheduled special elections each year. The Department expects to end the current year with expenditures of \$5.5 million, revenue of \$1.6 million, and a GFC of \$3.9 million, resulting in a surplus of \$5,823. Projected expenditures and revenues in forecast years reflect estimated charges for one scheduled election per fiscal year: a Presidential Primary Election in FY 2023-24, a Presidential General Election in FY 2024-25, and a statewide primary in FY 2025-26. The funds necessary to conduct mandated county, state and federal elections must be provided by the General Fund. Revenues from local districts reimburse the cost of their portion of the election. Services and supplies (including ballot printing, mailing and seasonal staffing) are projected to increase next year due to the size of the Presidential election before decreasing to approximately current year levels in future years.

Health	Modified Budget 2022-23	Year-End Estimate 2022-23	Forecast		
			2023-24	2024-25	2025-26
A. Operational Expenditures	\$ 141,096,372	\$ 114,278,514	\$ 112,917,241	\$ 110,633,149	\$ 112,155,222
B. COWCAP	9,401,378	9,401,377	9,401,377	9,401,377	9,401,377
C. Total Expenditures	150,497,750	123,679,891	122,318,618	120,034,526	121,556,599
D. Revenue	123,714,569	100,179,517	101,790,909	98,500,492	99,367,428
E. Financing Need, C-D	26,783,181	23,500,374	20,527,709	21,534,034	22,189,171
F. Preliminary GFC	26,783,181	26,783,181	16,071,286	16,071,286	16,071,286
G. Surplus/(Deficit), F-E	\$ -	\$ 3,282,807	\$ (4,456,423)	\$ (5,462,748)	\$ (6,117,885)

Health Department – The Health Department provides a wide array of services including but not limited to animal services, public health, clinic services, public guardian/conservator, administration, emergency medical services, and environmental health. The Department estimates year-end expenditures of \$123.7 million, revenues of \$100.2 million, and a financing need of \$23.5 million.

Year-end expenditures are estimated at \$26.8 million lower than budgeted primarily due to salary and benefits savings of \$18.7 million resulting from a vacancy rate of approximately 24% as the Department continues to struggle to find qualified staff across all bureaus, but particularly in the Primary Care Clinics and in the Public Health Bureau, and savings of \$8.1 million in services and supplies and fixed assets attributable to lower levels of services to the public than planned. Overall, most savings are in the categories of professional services, which will not be required due to the lower than planned staffing, and reimbursements to the State, as some reconciliations will rollover to next fiscal year. The total estimated expenditures include a liability payment to the State totaling \$1.9 million from budgeted restricted funds. As of March 2015, some Central California Alliance for Health members were moved from fee-for-service to capitation with the State performing yearly reconciliations. Any over payment for services rendered by the County found by the State must be returned. Revenue is projected to end the year \$23.5 million below budget. The high vacancy rate impacted the level of services provided, therefore decreasing revenue. The estimated impact to revenue from staff redirection to COVID-19 response activities is \$3.4 million.

Although the table depicts the Department ending the current fiscal year with a \$3.3 million surplus, the surplus is departmental unspent restricted funds. The projected surplus is primarily due to lower than planned reimbursements to the State. The Department projects ending within the allocated GFC in the current year. The Department will manage increases in salary, health insurance, and general liability in forecasted years. The projected deficits in the forecast years are clerical in nature, use of restricted funds was not included in those years.

Housing & Community Development	Modified Budget 2022-23	Year-End Estimate 2022-23	Forecast		
			2023-24	2024-25	2025-26
A. Operational Expenditures	\$17,506,157	\$16,618,626	\$17,463,946	\$17,373,430	\$17,842,965
B. COWCAP	1,994,209	1,994,209	1,994,209	1,994,209	1,994,209
C. Total Expenditures	19,500,366	18,612,835	19,458,155	19,367,639	19,837,174
D. Revenue	8,498,392	9,767,571	9,033,394	9,474,669	9,946,982
E. Financing Need, C-D	11,001,974	8,845,264	10,424,761	9,892,970	9,890,192
F. Preliminary GFC	11,001,974	11,001,974	9,460,876	9,460,876	9,460,876
G. Surplus/(Deficit), F-E	\$ -	\$ 2,156,710	\$ (963,885)	\$ (432,094)	\$ (429,316)

Housing and Community Development - The FY 2022-23 year-end estimate for Housing and Community Development consists of \$18.6 million in expenditures, revenues of \$9.8 million and a GFC of \$8.8 million resulting in a net estimated surplus of \$2.2 million. The savings is attributed to increased revenues from construction permits resulting from an increase in approved planning applications and salary and benefit savings due to vacancies. The Department continues to diligently review planning applications with support from outside consultants funded with ARPA dollars. The forecasted deficits are the result of a conservative approach to forecasting anticipated revenues and the ongoing increases in non-discretionary costs such as salary increases approved by the Board of Supervisors, pension cost increases, general liability, and property insurance premiums increases.

Human Resources	Modified Budget 2022-23	Year-End Estimate 2022-23	Forecast		
			2023-24	2024-25	2025-26
A. Operational Expenditures	\$ 7,061,848	\$ 6,715,958	\$ 7,387,511	\$ 7,513,806	\$ 7,603,713
B. COWCAP	(5,591,442)	(5,591,441)	(5,591,441)	(5,591,441)	(5,591,441)
C. Total Expenditures	1,470,406	1,124,517	1,796,070	1,922,365	2,012,272
D. Revenue	-	-	-	-	-
E. Financing Need, C-D	1,470,406	1,124,517	1,796,070	1,922,365	2,012,272
F. Preliminary GFC	1,470,406	1,470,406	1,504,906	1,504,906	1,504,906
G. Surplus/(Deficit), F-E	\$ -	\$ 345,889	\$ (291,164)	\$ (417,459)	\$ (507,366)

Human Resources-The Human Resources Department estimates expenditures of \$6.7 million financed by \$5.6 million in cost plan credits and GFC of \$1.1 million resulting in an estimated surplus of \$345,889 for the fiscal year. Estimated savings are primarily due to position vacancies. Conversely, deficits are projected in the forecasted years because of rising salary and benefit costs, such as wage increases, position step advances, pension contributions, workers’ compensation insurance, and general liability insurance.

Information Technology	Modified Budget 2022-23	Year-End Estimate 2022-23	Forecast		
			2023-24	2024-25	2025-26
A. Operational Expenditures	\$24,568,109	\$24,196,574	\$ 23,376,933	\$ 23,730,387	\$ 23,929,420
B. COWCAP	(25,248,810)	(25,248,810)	(25,248,810)	(25,248,810)	(25,248,810)
C. Total Expenditures	(680,701)	(1,052,236)	(1,871,877)	(1,518,423)	(1,319,390)
D. Revenue	550,000	550,000	550,000	550,000	550,000
E. Financing Need, C-D	(1,230,701)	(1,602,236)	(2,421,877)	(2,068,423)	(1,869,390)
F. Preliminary GFC	(1,230,701)	(1,230,701)	(5,628,739)	(5,628,739)	(5,628,739)
G. Surplus/(Deficit), F-E	\$ -	\$ 371,535	\$ (3,206,862)	\$ (3,560,316)	\$ (3,759,349)

Information Technology-The Information Technology Department estimates year-end operational expenditures of \$24.2 million, financed by \$25.2 million in cost plan credits, and revenue of \$550,000. Combined expenditure and income results in an estimated credit to the general fund of \$1.6 million; generating an estimated surplus of \$371,535. This estimated surplus is due primarily to unanticipated salary savings resulting from vacancies. Future forecast figures include an increase in operational expenses mostly due to salary and benefit costs and reflect a continued need for infrastructure projects. Without the inclusion of the capital costs the forecast years deficit diminishes by \$1.1 million each year for anticipated costs.

Probation	Modified Budget 2022-23	Year-End Estimate 2022-23	Forecast		
			2023-24	2024-25	2025-26
A. Operational Expenditures	\$59,904,752	\$59,899,116	\$61,207,243	\$61,633,523	\$61,778,319
B. COWCAP	4,234,569	4,234,569	4,234,569	4,234,569	4,234,569
C. Total Expenditures	64,139,321	64,133,685	65,441,812	65,868,092	66,012,888
D. Revenue	37,175,860	37,175,860	37,175,860	37,175,860	37,301,318
E. Financing Need, C-D	26,963,461	26,957,825	28,265,952	28,692,232	28,711,570
F. Preliminary GFC	26,963,461	26,963,461	26,330,497	26,330,497	26,330,497
G. Surplus/(Deficit), F-E	\$ -	\$ 5,636	\$ (1,935,455)	\$ (2,361,735)	\$ (2,381,073)

Probation – The Department’s year-end estimate reflects expenditures of \$64.1 million, revenue of \$37.2 million and a GFC of \$26.9 million. The estimated marginal surplus of \$5,636 is primarily due to anticipated savings in institutional supplies. The Department continues to mitigate increases in expenditures related to disaster response activities and overtime costs through careful use of resources and monitoring of operations. The forecast years reflect deficits ranging from \$1.9 to \$2.4 million. The deficits are due to estimated salary and benefit increases from negotiated bargaining agreements, higher pension contribution costs and cost increases for general liability and property insurance.

Public Defender	Modified Budget 2022-23	Year-End Estimate 2022-23	Forecast		
			2023-24	2024-25	2025-26
A. Operational Expenditures	\$16,451,668	\$16,538,749	\$16,508,464	\$16,780,972	\$16,941,608
B. COWCAP	1,997,969	1,934,541	1,934,541	1,934,541	1,934,541
C. Total Expenditures	18,449,637	18,473,290	18,443,005	18,715,513	18,876,149
D. Revenue	2,290,804	2,926,058	2,259,391	2,331,762	2,410,933
E. Financing Need, C-D	16,158,833	15,547,232	16,183,614	16,383,751	16,465,216
F. Preliminary GFC	16,158,833	16,158,833	15,280,086	15,280,086	15,280,086
G. Surplus/(Deficit), F-E	\$ -	\$ 611,601	\$ (903,528)	\$ (1,103,665)	\$ (1,185,130)

Public Defender - The year-end estimate for the Public Defender consists of \$18.5 million in expenditures, \$2.9 million in revenue, and a GFC of \$16.2 million. The Department projects a surplus of \$611,601 attributed to a multi-year State-funded grant for Public Defense to offset costs associated with attorney staffing support for youthful offenders and resentencing advocacy.

The Department projects a shortfall in the forecasted years driven by estimated cost increases related to newly negotiated labor agreements negotiations resulting in increased salary and benefits, pension, and health insurance premiums. The forecasted revenues include a reduction due to two one-time State-funded grants that are ending. The Public Defender will continue to seek new grant funding opportunities to offset increased costs. The revenue and expenditures will continue to fluctuate depending on trial-related costs, unanticipated expenses, and service agreements that maintain the operations of the Department.

Public Works, Facilities, & Parks	Modified Budget 2022-23	Year-End Estimate 2022-23	Forecast		
			2023-24	2024-25	2025-26
A. Operational Expenditures	\$ 26,033,944	\$ 25,313,066	\$ 25,106,057	\$ 25,851,132	\$ 26,260,552
B. COWCAP	(6,970,848)	(6,970,848)	(6,970,848)	(6,970,848)	(6,970,848)
C. Total Expenditures	19,063,096	18,342,218	18,135,209	18,880,284	19,289,704
D. Revenue	2,390,076	2,650,037	1,943,878	1,945,110	1,961,571
E. Financing Need, C-D	16,673,020	15,692,181	16,191,331	16,935,174	17,328,133
F. Preliminary GFC	16,673,020	16,673,020	14,389,056	14,389,056	14,389,056
G. Surplus/(Deficit), F-E	\$ -	\$ 980,839	\$ (1,802,275)	\$ (2,546,118)	\$ (2,939,077)

Public Works, Facilities, and Parks - The current year estimate projects expenditures of \$25.3 million financed by \$6.9 million in cost plan credits, revenues of \$2.7 million and GFC of \$16.7 million, for a net estimated surplus of \$1.0 million. The estimate reflects a decrease in budgeted expenditures of \$0.7 million and an increase in revenues of \$0.3 million. Salary and benefit savings from vacancies contributed to the decline of expenditures. The increase in revenue is primarily from reopening camping at San Lorenzo Park and an increase in park visitors at Lake San Antonio. Also, with the rise in utility costs, reimbursement revenue from the State Courts increased.

The forecasted deficits in outlying years are related to nondiscretionary cost increases, such as salaries, pension contributions, general liability, and property insurance premiums. The decline in revenues is related to a one-time operating transfer for the 911 Center HVAC system. Other fluctuations from the current year to the out years are from adjustments to the GFC for one-time allocations for facility unscheduled maintenance, COVID related facilities maintenance, parking citation processing, playground equipment and fire fuel abatement.

Sheriff	Modified Budget 2022-23	Year-End Estimate 2022-23	Forecast		
			2023-24	2024-25	2025-26
A. Operational Expenditures	\$130,647,742	\$135,000,906	\$140,081,087	\$143,249,496	\$146,162,260
B. COWCAP	10,156,705	10,156,705	10,156,705	10,156,705	10,156,705
C. Total Expenditures	140,804,447	145,157,611	150,237,792	153,406,201	156,318,965
D. Revenue	47,005,683	46,628,733	46,764,430	47,654,990	48,487,971
E. Financing Need, C-D	93,798,764	98,528,878	103,473,362	105,751,211	107,830,994
F. Preliminary GFC	93,798,764	93,798,764	92,588,833	92,588,833	92,588,833
G. Surplus/(Deficit), F-E	\$ -	\$ (4,730,114)	\$ (10,884,529)	\$ (13,162,378)	\$ (15,242,161)

Sheriff-Coroner – The Sheriff’s Office projects ending the current fiscal year with a deficit estimated at \$4.7 million. Expenditures are estimated at \$145.2 million, or \$4.4 million higher than budget, while revenues are estimated at \$46.6 million. The decrease in revenue is attributable to special events that were canceled due to the ongoing pandemic and lower revenues from the MOU for the School Resource Office. The financing need is estimated to be \$98.5 million.

The increase in expenditures is due to unbudgeted overtime, a \$1.9 million increase in Inmate Medical Agreement, \$800,000 outfitting for replacement fleet vehicles, \$271,000 increase in property insurance for the new jail, salary increases for employee bargaining units, and disaster and pandemic response expenditures. In accordance with the county’s financial policies, the department will present a report to the budget committee during its February 2023 meeting to provide more details about the steps the department is taking to address the impacts of the current year estimated deficit.

The Sheriff's Office projects growing deficits in forecast years increasing to \$15.2 million in FY 2025-26 due to significant increases in inmate medical costs amounting to \$4.1 million in FY2023-24 with annual increase of 4% thereafter, salary and benefits from negotiated bargaining agreements, fleet, general liability, and workers compensation insurance in the next three years.

Social Services	Modified Budget 2022-23	Year-End Estimate 2022-23	Forecast		
			2023-24	2024-25	2025-26
A. Operational Expenditures	\$229,920,113	\$234,017,985	\$237,667,108	\$240,873,454	\$246,372,768
B. COWCAP	13,826,333	13,826,333	13,826,333	13,826,333	13,826,333
C. Total Expenditures	243,746,446	247,844,318	251,493,441	254,699,787	260,199,101
D. Revenue	218,019,942	222,608,263	225,933,983	228,631,498	231,036,762
E. Financing Need, C-D	25,726,504	25,236,055	25,559,458	26,068,289	29,162,339
F. Preliminary GFC	25,726,504	25,726,504	21,628,012	21,628,012	21,628,012
G. Surplus/(Deficit), F-E	\$ -	\$ 490,449	\$ (3,931,446)	\$ (4,440,277)	\$ (7,534,327)

Social Services – The Department of Social Services (DSS) estimates year-end expenditure of \$247.8 million, revenue of \$222.6 million and GFC of \$25.2 million, resulting in a surplus of approximately \$500,000. The estimated surplus results from \$400,000 of unused American Rescue Plan Act funds for Project Roomkey which has been offset by State Project Roomkey funding that was rolled over from FY 2021-22 and the remaining balance of \$100,000 is related to savings due to a lower caseload in the General Assistance Program.

Although the table above seems to indicate the department will exceed its FY 2022-23 approved appropriations, that is not the case. Due to timing, a \$4.1 million increase in appropriations and revenue for the Emergency Rental Assistance Program was not included in the modified budget figures above. Once the Board approves this modification to the budget, the issue will be resolved. Pandemic related disaster recovery revenue is also not factored in the estimate

Expenditures and revenues in the forecast years are estimated to increase; but revenue growth is projected to lag expenditure growth resulting in deficits. Most of the deficits results from IHSS Provider negotiated rate changes, which impact the County's MOE, and the loss of revenue for Military and Veterans Affairs due to claiming changes. Some of these cost increases can be offset with realignment growth, but it is projected some financing gaps will remain.

Treasurer- Tax Collector	Modified Budget 2022-23	Year-End Estimate 2022-23	Forecast		
			2023-24	2024-25	2025-26
A. Operational Expenditures	\$ 9,432,557	\$ 8,090,111	\$ 8,844,514	\$ 9,178,720	\$ 9,313,344
B. COWCAP	81,957	81,957	81,957	81,957	81,957
C. Total Expenditures	9,514,514	8,172,068	8,926,471	9,260,677	9,395,301
D. Revenue	7,451,566	6,406,416	6,717,662	6,906,695	6,945,278
E. Financing Need, C-D	2,062,948	1,765,652	2,208,809	2,353,982	2,450,023
F. Preliminary GFC	2,062,948	2,062,948	2,046,465	2,046,465	2,046,465
G. Surplus/(Deficit), F-E	\$ -	\$ 297,296	\$ (162,344)	\$ (307,517)	\$ (403,558)

Treasurer-Tax Collector - The Treasurer-Tax Collector (TTC) projects year-end expenditures of \$8.2 million, revenue of \$6.4 million, and a GFC of \$1.8 million; resulting in an estimated surplus of \$297,296. The surplus is possible since expenditures are estimated to be under budget by \$1,3 million, primarily due

Three Year Forecast

to lower salary and benefit expenditures resulting from vacancies and delayed recruitments. However, these savings were also partially offset by new expenses due to recent labor union agreements and employee leave payouts. Revenue is projected to be \$1,0 million below budget largely due to lower levels of reimbursable expenditures in the TTC’s Revenue and Treasury Divisions. In addition, the repeal of various administrative fees by Assembly Bills 177 and 199 continues to negatively impact previously collectible revenue sources.

Estimated expenditures in forecasted years include negotiated cost of living increases, earned step increases, increases in service agreement expenditures, and countywide increases for healthcare insurance, PERS Retirement, property insurance, and other internal service charges. Forecasted revenue assumes allowable cost recovery based on estimated expenditures for the Revenue Division, Treasury services, and conservative increases based on recent and current year experience.

OTHER MAJOR FUNDS

Road Fund – The Road Fund is a special revenue fund established by State law to account for revenues legally restricted revenues for the County’s Road and bridge projects and related maintenance. The Road Fund’s primary funding sources are State Highway User Tax Allocation (HUTA or Gas Tax), the Transportation Agency for Monterey County (TAMC) retail transaction and use tax ordinance (Measure X), the Road Repair and Accountability Act of 2017 (Senate Bill 1 [SB1]), and Transient Occupancy Tax (TOT). Measure X and SB1 are newer revenue streams that produce annual revenues of \$9.0 million and \$10.0 million, respectively.

Fund 002 Road Fund	Modified Budget 2022-23	Year-End Estimate 2022-23	Forecast		
			2023-24	2024-25	2025-26
A. Beginning Fund Balance	\$ 18,531,866	\$ 21,070,513	\$ 22,853,383	\$ 5,361,320	\$ (8,101,742)
B. Revenue	79,607,646	66,036,485	51,490,797	68,641,112	60,018,996
C. Cancellation of Assignments	-	-	-	-	-
D. Total Financing, A+B+C	98,139,512	87,106,998	74,344,180	74,002,432	51,917,254
E. Expenditures	77,068,999	64,253,615	68,982,860	82,104,174	71,524,838
F. Provisions for Assignments	-	-	-	-	-
G. Total Financing Uses, E+F	77,068,999	64,253,615	68,982,860	82,104,174	71,524,838
H. Ending Fund Balance, D-G	\$ 21,070,513	\$ 22,853,383	\$ 5,361,320	\$ (8,101,742)	\$ (19,607,584)

The current year revenue estimate is \$13.6 million less than budget due to delays in construction of federally funded projects. Two construction phase projects will shift to FY 2024-25, the Davis Road Bridge and Monte Road Bridge projects totaling \$4.7 million. In addition, two scheduled projects, G-12 Pajaro to Prunedale Corridor Study - Segment 1 and Segment 6 are now unfunded due to Caltrans’ closeout of Monterey Bay Scenic Trail projects scheduled for construction. Accordingly, revenues are projected to decrease by \$14.6 million in FY 2023-24, increase by \$17.2 million in FY 2024-25, and decrease by \$8.6 million in FY 2025-26.

Estimated expenditures are \$12.8 million under budget as several large projects’ construction phases were deferred until FY 2024-25. Variances between the current year budget and forecasted estimates are primarily due to changes in project timelines due to the significant natural events from fire and the winter storm events, weather, permitting, and staffing constraints. Expenditures in FY 2023-24 are projected to increase by \$4.7 million due to major projects scheduled, which include Old Stage Road Rehabilitation, Palo Colorado, and Hunter Lane Reconstruction. Expenditures in FY 2024-25 are projected to increase by

\$13.1 million and in FY 2025-26 are projected to decrease by \$10.6 million as federal funded projects are anticipated to be completed.

Over the last several fiscal years, expenditures have not increased at the same pace as revenues, resulting in a growing fund balance. This is due to the new funding streams, Measure X and SB 1, accumulating. The Public Works, Facilities & Parks Department plans to gradually increase staffing and consultant support to allow for more projects to be completed. As more projects are completed, fund balance will decline. Fund balance is projected to decrease in FY 2024-25 as the fund is projected to have a reduction in federally funded projects. In the forecast, fund balance is a primary financing source for the Pavement Asset Management Program that increases the pavement condition index to fair standards. The Department is awaiting approval, direction, on the proposed bond financing program.

Monterey County Free Libraries – For the current fiscal year end, the Library Department is projecting an addition of \$571,244 to existing Fund Balance. The Department’s expenditures are \$776,552 below budget primarily due to salary savings for vacant positions. Other operational expenditures are in line with the adopted budget. The Library continues facilitating distance learning and remote library use through Library By Mail, added content and expenses for online resources such as e-books, downloadable audio, and other online resources.

Fund 003 Monterey County Free Libraries	Modified Budget 2022-23	Year-End Estimate 2022-23	Forecast		
			2023-24	2024-25	2025-26
A. Beginning Fund Balance	\$ 6,270,108	\$ 6,270,108	\$ 6,841,352	\$ 7,180,417	\$ 7,706,909
B. Revenue	13,003,540	12,933,540	11,639,615	12,042,325	12,458,610
C. Cancellation of Assignments	-	-	-	-	-
D. Total Financing, A+B+C	19,273,648	19,203,648	18,480,967	19,222,742	20,165,519
E. Expenditures	13,138,848	12,362,296	11,300,550	11,515,833	11,682,104
F. Provisions for Assignments	-	-	-	-	-
G. Total Financing Uses, E+F	13,138,848	12,362,296	11,300,550	11,515,833	11,682,104
H. Ending Fund Balance, D-G	\$ 6,134,800	\$ 6,841,352	\$ 7,180,417	\$ 7,706,909	\$ 8,483,415

Current year revenue is \$70,000 below budget, primarily due to lower library services revenue (due to the removal of fines last year) and a slight decrease in contributions from the Foundation from Monterey County Free Libraries (FMCFL) and Friends of the Libraries groups.

For forecasted period, the Library projects an increase in Fund Balance primarily due to favorable property tax projections increasing at a rate of 5% next year and 3.5% on subsequent years. Property tax revenue is the biggest revenue source for the Department.

Staff continues their commitment to garner technology and library services grants to augment program and technology needs. The California State Library’s financial support of some pandemic resources will end in FY 2023-24. Ongoing assessment of staffing needs should result in continued realignment of vacant positions, however continued work on the new Bradley Library, and anticipated increase in stops for the new North Bookmobile may result in increased staffing needs.

The Foundation for Monterey County Free Libraries is committed to continue funding ongoing programs such as Homework Centers, Summer Reading Program, and outreach to youth in the community, and they continue to rebuild from their drop in revenue resulting in less dedicated funding in calendar year 2022

compared to calendar year 2021, so library services will adjust or reduce accordingly. Various Friends of the Library groups continue to support and fundraise on behalf of local branch libraries.

The Library’s capital improvement projects for the next three years include the addition of a rural library in Bradley. The Director is working toward developing a library services solution for the East Garrison community and exploring possible leases in partnership with cities and school districts. Projected in the Capital Improvement Program are outlays for Fixtures, Furniture, and Equipment for the new Gonzales Branch, and significant repairs to the Pajaro Branch.

Behavioral Health – Pursuant to Welfare and Institutions Code Section 5600, the Health Department’s Behavioral Health Bureau provides a continuum of County operated and community-based substance use disorder and mental health services. The program provides community prevention programs, crisis intervention, inpatient psychiatric services, social rehabilitation, supportive housing, and outpatient services primarily to Monterey County Medi-Cal beneficiaries who meet the State Department of Health Care Services, Mental Health Division’s medical necessity criteria. In addition, the program also serves many non-Medi-Cal eligible residents who have behavioral health disorders. All the financial activity for these services is captured in the Behavioral Health Fund (fund 23).

Fund 023 Behavioral Health	Modified Budget 2022-23	Year-End Estimate 2022-23	Forecast		
			2023-24	2024-25	2025-26
A. Beginning Fund Balance	\$62,593,487	\$62,593,487	\$58,543,335	\$ 55,081,381	\$ 51,135,641
B. Revenue	150,279,106	139,961,602	143,340,282	143,340,282	143,340,282
C. Cancellation of Assignments	-	-	-	-	-
D. Total Financing, A+B+C	212,872,593	202,555,089	201,883,617	198,421,663	194,475,923
E. Expenditures	157,398,704	144,011,754	146,802,236	147,286,022	148,206,401
F. Provisions for Assignments	-	-	-	-	-
G. Total Financing Uses, E+F	157,398,704	144,011,754	146,802,236	147,286,022	148,206,401
H. Ending Fund Balance, D-G	\$55,473,889	\$58,543,335	\$55,081,381	\$ 51,135,641	\$ 46,269,522

For the current fiscal year, expenditures for the Behavioral Health Fund are estimated at \$144.0 million and revenues are estimated at \$139.9 million; resulting in an estimated decrease of fund balance of \$4.1 million.

Expenditures are estimated approximately \$13.4 million below the modified budget of \$157.4 million. The lower expenditures are attributable to a higher than budgeted vacancy rate generating \$5.4 million in salary and benefit savings, lower than anticipated operating transfer in the Whole Person Care program in the amount of \$2.9 million, and lower than anticipated services and supplies costs of approximately \$5.0 million.

Current year-end revenue is estimated at \$139.9 million, which is approximately \$10.4 million below the modified budget of \$150.3 million. The decrease in revenues is attributable to lower Mental Health Services Act (MHSA) revenues of approximately \$6.0 million and lower than anticipated Federal Financial Participation reimbursements of \$4.4 million.

The forecast years depict a decrease in expenditures and revenues, as compared to the modified budget, due to the phase-out of the Whole Person Care program, which ended on December 2021 but still had expenditures in FY 22-23. Excluding this significant change, increases in salary and benefits, operating cost increases such as insurance costs, and contracted services are projected to increase. This combined with anticipated impacts to revenue streams in realignment and Mental Health Services Act (MHSA) project a significant decrease in fund balance. MCHB will monitor these impacts as it prepares its FY 2023-24 budget and will adjust as needed to minimize this impact. As reported in the FY 2022-23 year-end report, the fund balance includes \$8.4 million in assigned funds for potential future Medi-Cal program settlement costs.

Emergency Communications - The Emergency Communications Department provides dispatch and call taking (9-1-1 and non-emergency) to Monterey County residents and law enforcement, fire protection and emergency medical dispatch services for over 30 local, regional, county, and State public safety agencies.

Fund 028 Emergency Communications	Modified Budget 2022-23	Year-End Estimate 2022-23	Forecast		
			2023-24	2024-25	2025-26
A. Beginning Fund Balance	\$ 3,381,708	\$ 3,381,708	\$ 3,105,714	\$ 2,854,197	\$ 2,614,916
B. Revenue	13,238,353	12,615,703	14,110,839	14,552,538	14,507,651
C. Cancellation of Assignments	-	-	-	-	-
D. Total Financing, A+B+C	16,620,061	15,997,411	17,216,553	17,406,735	17,122,567
E. Expenditures	12,909,353	12,891,697	14,362,356	14,791,819	14,606,780
F. Provisions for Assignments	-	-	-	-	-
G. Total Financing Uses, E+F	12,909,353	12,891,697	14,362,356	14,791,819	14,606,780
H. Ending Fund Balance, D-G	\$ 3,710,708	\$ 3,105,714	\$ 2,854,197	\$ 2,614,916	\$ 2,515,787

The Department is operating under a special revenue fund and expects to end the current year with expenditures totaling \$12.9 million and revenue totaling \$12.6 million, including a County GFC of \$841,021 resulting in a decrease in fund balance of approximately \$276,000.

The Department estimates a planned addition to the department’s reserve of \$329,000 in the current year. This addition to the reserve was planned through the annual budgeting process and will be set aside for future replacement and upgrades to the Department’s equipment, systems, and building. The reserve is not intended to pay for ongoing operating costs. The Department’s fund balance is expected to decrease due to a reduction of GFC in the current year resulting from an overcollection of Public Safety Sales Tax funds collected in the fund in the prior year.

Costs are expected to rise in the forecast years due to escalating salaries, pension, healthcare, and insurance costs as well as rising costs of service agreements that maintain the operations at the Department. Costs are charged pursuant to the formula in the 9-1-1 Services Agreement which allocates costs to the agencies served through a 3-factor ratio of jurisdictional workload, property value, and population. The Department anticipates continuing to build its reserves through the forecast years using that cost sharing ratio.

Natividad – Natividad is a County enterprise fund, defined as a governmental fund that provides goods and services to the public for a fee, making the entity self-supporting.

Fund 451 Natividad	Modified Budget 2022-23	Year-End Estimate 2022-23	Forecast		
			2023-24	2024-25	2025-26
A. Beginning Fund Balance	\$225,199,071	\$225,199,071	\$247,065,675	\$ 250,872,366	\$ 257,630,219
B. Revenue	384,650,960	404,393,676	418,604,380	428,453,531	437,200,899
C. Cancellation of Assignments	-	-	-	-	-
D. Total Financing, A+B+C	609,850,031	629,592,747	665,670,055	679,325,897	694,831,118
E. Expenditures	366,221,605	382,527,072	414,797,689	421,695,678	428,821,911
F. Provisions for Assignments	-	-	-	-	-
G. Total Financing Uses, E+F	366,221,605	382,527,072	414,797,689	421,695,678	428,821,911
H. Ending Fund Balance, D-G	\$243,628,426	\$247,065,675	\$250,872,366	\$ 257,630,219	\$ 266,009,207

Natividad estimates to end the current year with \$3.4 million higher net operating results than budget. The pandemic continues to impact the operations to both revenues and expenses. The expected average daily census was 122.3 while the actual has been 127.1. The higher than anticipated inpatient census has been for trauma services and general (non-COVID) patients. However, patients with COVID continue to be treated, but at a lower volume than prior years. The increase in net operating results comes from an increase in the census and government assistance for higher expenses in providing care.

Expenditures in the current year are estimated at \$16.3 million over budget. Labor and supplies expenses are major contributors to increases in expenditures. While higher volume contributed to additional costs, contracted or travel nurses and labor for ancillary services significantly added to labor expenses. Annual wage and benefits cost increases also factor into the higher labor costs. Contracted physicians and operating costs continue to be high compared to previous years.

The current year and the forecasted years include costs for capital projects. Natividad forecasts to spend on average \$20.0 million annually on capital projects. Proposed projects may include: Emergency department remodel and upgrade to improve patient flow, upgrade tube system between Rehab, Labor and Delivery and Medical Surgical units, upgrade laboratory tracking system for testing, upgrade alarm fire alarm system, upgrade communication system – phone, replacement of computers on wheels for patient information, and replacement of general medical equipment.

NMC projects an increase in net position from operations over the current and forecasted years.

Lake & Resort Operations – The Lake & Resort Operations Fund is an enterprise fund accounting for Lake Nacimiento operations. It is a self-supporting entity, providing goods and services to the public for a fee. The Resort at Lake Nacimiento is managed under an agreement with an external operator, Vista Recreation. The agreement allows for reimbursement of the operator’s expenditures in addition to monthly management and annual incentive fees. The County is responsible for capital expenses such as repairs to infrastructure.

Fund 452 Lake & Resort Operations	Modified Budget 2022-23	Year-End Estimate 2022-23	Forecast		
			2023-24	2024-25	2025-26
A. Beginning Fund Balance	\$ 2,323,808	\$ 2,323,808	\$ 1,896,416	\$ 1,998,979	\$ 1,583,970
B. Revenue	4,603,639	3,271,332	3,905,930	3,488,313	3,592,947
C. Cancellation of Assignments	-	-	-	-	-
D. Total Financing, A+B+C	6,927,447	5,595,140	5,802,346	5,487,292	5,176,917
E. Expenditures	4,193,603	3,698,724	3,803,367	3,903,322	4,026,091
F. Provisions for Assignments	-	-	-	-	-
G. Total Financing Uses, E+F	4,193,603	3,698,724	3,803,367	3,903,322	4,026,091
H. Ending Fund Balance, D-G	\$ 2,733,844	\$ 1,896,416	\$ 1,998,979	\$ 1,583,970	\$ 1,150,826

Lake Nacimiento began the year with a net position of \$2.3 million, with \$0.9 million restricted for Zebra/Quagga Mussel Program and 2018 trailer fire insurance proceeds, \$1.0 million for investment in capital assets, and \$0.4 million unrestricted. The current year estimate anticipates revenues and expenditures of \$3.3 million and \$3.7 million, respectively, for a net loss of \$0.4 million. Revenue is expected to come under budget by \$1.3 million, while expenditures are \$0.5 million lower than budget, with anticipated \$0.4 million net loss compared to the budgeted net gain of \$0.4 million. Vista Recreation anticipated a more favorable year, post-pandemic. However, with water levels around 30% capacity, July through November revenues alone fell under budget by \$0.8 million. Demand for recreational activities,

such as boating, also declined with rising fuel prices. The operator responded quickly by reducing labor costs to minimize losses.

Revenue forecasts for the next three years, reflect modest increases, in anticipation of increased demand for recreational activities as 10 new boats will be added to the fleet in April 2023. This is expected to increase boat rental, day use, lodging, camping, and fuel sales revenues. The County will receive 15% of gross revenues from boat rentals, with no related costs for the operator-owned fleet. The final settlement payment for the Water World Resort liability is due in June 2024, which will then eliminate the need for a General Fund subsidy, lowering FY 2024-25 revenues. Expenditure forecasts for the next three years grow on average \$0.1 million each year in anticipation of higher payroll and other direct costs. As in the past challenging years, Vista Recreation will exercise appropriate measures to control all revenue-driven costs.

Laguna Seca Recreation Area (Laguna Seca) – Laguna Seca is owned by the County and functions as a fee-for-service enterprise. Operations are managed by A&D Narigi Consulting, LLC (A&D). LSRA operations include camping, track rentals, venue rentals, corporate team-building packages, and special events, including local and international gatherings. As an enterprise fund, the fees collected from its operations are its sole financing source to fully cover its operating costs and asset improvement and replacement needs.

Fund 453 Laguna Seca Recreation Area	Modified Budget 2022-23	Year-End Estimate 2022-23	Forecast		
			2023-24	2024-25	2025-26
A. Beginning Fund Balance	\$ 9,863,458	\$ 9,863,458	\$ 9,110,499	\$ 11,543,791	\$ 13,942,424
B. Revenue	18,044,645	16,982,410	27,910,641	27,910,641	27,910,641
C. Cancellation of Assignments					
D. Total Financing, A+B+C	27,908,103	26,845,868	37,021,140	39,454,432	41,853,065
E. Expenditures	18,560,643	17,735,369	25,477,349	25,512,008	25,532,202
F. Provisions for Assignments					
G. Total Financing Uses, E+F	18,560,643	17,735,369	25,477,349	25,512,008	25,532,202
H. Ending Fund Balance, D-G	\$ 9,347,460	\$ 9,110,499	\$ 11,543,791	\$ 13,942,424	\$ 16,320,863

Current year estimates project \$17.0 million of revenues and \$17.7 million of expenditures, which will reduce the net position by \$0.8 million, from \$9.9 million to \$9.1 million. The anticipated revenues are lower than budget due largely to the bridge and track rehabilitation project which requires the track be closed during construction for a minimum of five months. There were also delays in migrating to new ticketing and merchandise online sales portals, which likely caused some reduced revenues.

The forecasted years are anticipated to be the turnaround years, especially after the completion of the bridge and track capital projects. The forecasts anticipate an annual revenue forecast of \$27.9 million. A&D is optimistic that these years will be its break-out years, hoping to see pre-pandemic activity from both returning and new patrons. Expenses are forecasted to increase annually, primarily due to increased service and supply costs, in anticipation of increased costs that are vital to bringing in more revenues by inviting new racetrack enthusiasts, as well as reconnecting with both international and local patrons. The higher revenue forecasts are expected to yield an average of \$2.4 million of net income annually, which would increase Net Position to \$16.3 million by FY 2025-26.

Expenditure/Revenue History by Department for All Funds

Department		FY 2017-18 Actual	FY 2018-19 Actual	FY 2019-20 Actual	FY 2020-21 Actual	FY 2021-22 Actual	FY 2022-23 Estimated	FY 2023-24 Recommended
Board of Supervisors 1000								
Expenditures	\$	3,760,068	\$ 3,927,926	\$ 3,860,835	\$ 3,775,231	\$ 4,378,314	\$ 4,692,219	\$ 4,958,011
Revenue	\$	-	\$ -	\$ 10	\$ 6,691	\$ 10	\$ -	\$ -
GF Contribution	\$	3,760,068	\$ 3,927,926	\$ 3,860,825	\$ 3,768,540	\$ 4,378,304	\$ 4,692,219	\$ 4,958,011
Department of Emergency Management 1040								
Expenditures	\$	-	\$ -	\$ -	\$ -	\$ -	\$ -	\$ 4,396,683
Revenue	\$	-	\$ -	\$ -	\$ -	\$ -	\$ -	\$ 1,433,683
GF Contribution/Fund Balance	\$	-	\$ -	\$ -	\$ -	\$ -	\$ -	\$ 2,963,000
County Administrative Office 1050								
Expenditures	\$	78,537,390	\$ 70,217,348	\$ 79,333,628	\$ 147,170,894	\$ 83,510,122	\$ 110,585,172	\$ 70,838,833
Revenue	\$	279,314,659	\$ 288,471,074	\$ 290,974,629	\$ 404,593,759	\$ 361,334,542	\$ 362,992,991	\$ 351,342,916
GF Contribution/Fund Balance	\$	(200,777,269)	\$ (218,253,726)	\$ (211,641,001)	\$ (257,422,865)	\$ (277,824,419)	\$ (252,407,819)	\$ (280,504,083)
County Administrative Office Departmental 1050_CAO_BR								
Expenditures	\$	7,910,710	\$ 7,701,514	\$ 14,590,950	\$ 46,344,913	\$ 39,342,515	\$ 19,350,643	\$ 19,036,902
Revenue	\$	6,783,914	\$ 8,009,962	\$ 8,363,075	\$ 21,654,439	\$ 30,215,465	\$ 10,701,184	\$ 13,901,002
GF Contribution	\$	1,126,796	\$ (308,448)	\$ 6,227,875	\$ 24,690,474	\$ 9,127,050	\$ 8,649,459	\$ 5,135,900
County Administrative Office Nondepartmental 1050_CAON_BR								
Expenditures	\$	70,626,680	\$ 62,515,834	\$ 64,742,678	\$ 100,825,981	\$ 44,167,607	\$ 91,234,529	\$ 51,801,931
Revenue	\$	272,530,746	\$ 280,461,112	\$ 282,611,555	\$ 382,939,320	\$ 331,119,077	\$ 352,291,807	\$ 337,441,914
GF Contribution/Fund Balance	\$	(201,904,066)	\$ (217,945,278)	\$ (217,868,877)	\$ (282,113,339)	\$ (286,951,469)	\$ (261,057,278)	\$ (285,639,983)
Human Resources 1060								
Expenditures	\$	12,817,763	\$ 11,704,919	\$ 11,548,066	\$ 15,430,656	\$ 13,617,246	\$ 14,135,219	\$ 15,100,658
Revenue	\$	11,309,682	\$ 11,821,329	\$ 12,270,471	\$ 11,569,020	\$ 11,457,407	\$ 10,766,525	\$ 12,528,549
GF Contribution/Fund Balance	\$	1,508,081	\$ (116,410)	\$ (722,405)	\$ 3,861,636	\$ 2,159,839	\$ 3,368,694	\$ 2,572,109
Human Resources Departmental 1060_HRB_BR								
Expenditures	\$	909,328	\$ (851,332)	\$ (919,550)	\$ 102,819	\$ 796,291	\$ 1,124,517	\$ 669,827
Revenue	\$	172	\$ -	\$ -	\$ 8,913	\$ -	\$ -	\$ -
GF Contribution	\$	909,156	\$ (851,332)	\$ (919,550)	\$ 93,906	\$ 796,291	\$ 1,124,517	\$ 669,827
Human Resources Nondepartmental 1060_HRN_BR								
Expenditures	\$	9,280,850	\$ 12,556,251	\$ 12,467,616	\$ 15,327,837	\$ 12,820,956	\$ 13,010,702	\$ 14,430,831
Revenue	\$	9,547,729	\$ 11,821,329	\$ 12,270,471	\$ 11,560,107	\$ 11,457,407	\$ 10,766,525	\$ 12,528,549
Fund Balance	\$	(266,879)	\$ 734,922	\$ 197,145	\$ 3,767,730	\$ 1,363,548	\$ 2,244,177	\$ 1,902,282
Economic Development* 1070								
Expenditures	\$	10,761,686	\$ 7,813,551	\$ (904)				
Revenue	\$	7,894,518	\$ 5,087,666	\$ 18,233				
GF Contribution/Fund Balance	\$	2,867,168	\$ 2,725,885	\$ (19,137)				
Civil Rights Office 1080								
Expenditures	\$	(206,384)	\$ 43,642	\$ (178,221)	\$ (400,639)	\$ (60,001)	\$ 313,144	\$ 407,997
Revenue	\$	-	\$ -	\$ -	\$ 1,356	\$ -	\$ -	\$ -
GF Contribution	\$	(206,384)	\$ 43,642	\$ (178,221)	\$ (401,995)	\$ (60,001)	\$ 313,144	\$ 407,997
Auditor-Controller 1110								
Expenditures	\$	128,845,450	\$ 16,976,937	\$ 51,358,067	\$ 16,301,489	\$ 16,945,684	\$ 17,570,788	\$ 17,779,954
Revenue	\$	124,484,043	\$ 22,098,301	\$ 50,550,903	\$ 16,502,494	\$ 16,721,636	\$ 16,586,370	\$ 16,202,585
GF Contribution/Fund Balance	\$	4,361,407	\$ (5,121,364)	\$ 807,164	\$ (201,005)	\$ 224,048	\$ 984,418	\$ 1,577,369
Auditor-Controller Departmental 1110_AUDC_DV								
Expenditures	\$	(9,112)	\$ 458,040	\$ 1,195,336	\$ 404,239	\$ 962,165	\$ 1,473,378	\$ 2,083,049
Revenue	\$	499,290	\$ 497,350	\$ 535,564	\$ 614,595	\$ 732,768	\$ 607,845	\$ 722,060
GF Contribution	\$	(508,402)	\$ (39,310)	\$ 659,772	\$ (210,356)	\$ 229,397	\$ 865,533	\$ 1,360,989
Auditor-Controller Nondepartmental 1110_ACNO_DV								
Expenditures	\$	128,854,562	\$ 16,518,896	\$ 50,162,731	\$ 15,897,250	\$ 15,983,520	\$ 16,097,410	\$ 15,696,905
Revenue	\$	123,984,754	\$ 21,600,951	\$ 50,015,339	\$ 15,887,900	\$ 15,988,869	\$ 15,978,525	\$ 15,480,525
GF Contribution/Fund Balance	\$	4,869,808	\$ (5,082,055)	\$ 147,392	\$ 9,350	\$ (5,349)	\$ 118,885	\$ 216,380
Treasurer-Tax Collector 1170								
Expenditures	\$	6,997,213	\$ 7,081,120	\$ 6,140,429	\$ 5,699,263	\$ 7,278,438	\$ 8,172,068	\$ 9,928,945
Revenue	\$	5,455,113	\$ 6,109,579	\$ 5,501,902	\$ 5,913,956	\$ 6,101,434	\$ 6,406,416	\$ 8,014,936
GF Contribution	\$	1,542,100	\$ 971,541	\$ 638,527	\$ (214,693)	\$ 1,177,004	\$ 1,765,652	\$ 1,914,009
Assessor-County Clerk-Recorder 1180								
Expenditures	\$	8,477,647	\$ 8,420,070	\$ 8,846,844	\$ 9,218,095	\$ 12,349,986	\$ 11,206,931	\$ 10,816,670
Revenue	\$	6,182,701	\$ 3,774,007	\$ 4,464,344	\$ 6,079,409	\$ 7,273,980	\$ 4,185,319	\$ 4,612,000
GF Contribution	\$	2,294,946	\$ 4,646,063	\$ 4,382,500	\$ 3,138,687	\$ 5,076,006	\$ 7,021,612	\$ 6,204,670

Department		FY 2017-18 Actual	FY 2018-19 Actual	FY 2019-20 Actual	FY 2020-21 Actual	FY 2021-22 Actual	FY 2022-23 Estimated	FY 2023-24 Recommended
County Counsel								
1210	Expenditures	\$ 33,454,057	\$ 44,260,706	\$ 49,699,262	\$ 36,429,310	\$ 46,612,966	\$ 46,752,198	\$ 50,898,799
	Revenue	\$ 34,306,977	\$ 40,652,689	\$ 47,038,552	\$ 44,346,589	\$ 49,591,968	\$ 45,737,820	\$ 49,365,788
	GF Contribution/Fund Balance	\$ (852,920)	\$ 3,608,017	\$ 2,660,710	\$ (7,917,279)	\$ (2,979,001)	\$ 1,014,378	\$ 1,533,011
County Counsel								
Departmental	Expenditures	\$ (873,768)	\$ 213,602	\$ 578,165	\$ 2,098,022	\$ 1,885,434	\$ 1,077,381	\$ 1,558,167
1210_CCOUN_BR	Revenue	\$ 357,308	\$ 458,330	\$ 541,615	\$ 570,722	\$ 494,275	\$ 408,894	\$ 400,000
	GF Contribution	\$ (1,231,076)	\$ (244,728)	\$ 36,550	\$ 1,527,300	\$ 1,391,160	\$ 668,487	\$ 1,158,167
County Counsel								
Nondepartmental	Expenditures	\$ 34,327,825	\$ 44,047,104	\$ 49,121,097	\$ 34,331,288	\$ 44,727,532	\$ 45,674,817	\$ 49,340,632
1210_CCND_BR	Revenue	\$ 33,949,668	\$ 40,194,360	\$ 46,496,938	\$ 43,775,868	\$ 49,097,693	\$ 45,328,926	\$ 48,965,788
	GF Contribution/Fund Balance	\$ 378,157	\$ 3,852,744	\$ 2,624,159	\$ (9,444,580)	\$ (4,370,161)	\$ 345,891	\$ 374,844
Clerk of the Board								
1300	Expenditures	\$ 916,390	\$ 783,508	\$ 754,012	\$ 840,624	\$ 916,246	\$ 1,049,273	\$ 1,207,047
	Revenue	\$ 23,431	\$ 19,365	\$ 21,944	\$ 14,101	\$ 23,166	\$ 10,000	\$ 20,000
	GF Contribution	\$ 892,959	\$ 764,143	\$ 732,068	\$ 826,523	\$ 893,081	\$ 1,039,273	\$ 1,187,047
Elections								
1410	Expenditures	\$ 4,473,705	\$ 3,662,061	\$ 5,203,287	\$ 7,828,304	\$ 6,544,109	\$ 5,518,578	\$ 6,578,144
	Revenue	\$ 914,004	\$ 1,929,851	\$ 1,053,587	\$ 3,673,609	\$ 3,471,676	\$ 1,580,493	\$ 748,710
	GF Contribution	\$ 3,559,701	\$ 1,732,210	\$ 4,149,700	\$ 4,154,695	\$ 3,072,433	\$ 3,938,085	\$ 5,829,434
Emergency Communications								
1520	Expenditures	\$ 12,498,468	\$ 13,391,864	\$ 12,505,357	\$ 13,160,438	\$ 12,477,314	\$ 16,033,813	\$ 15,616,044
	Revenue	\$ 12,131,358	\$ 11,993,511	\$ 13,965,878	\$ 14,079,889	\$ 14,569,026	\$ 14,221,819	\$ 15,069,995
	GF Contribution/Fund Balance	\$ 367,110	\$ 1,398,353	\$ (1,460,521)	\$ (919,452)	\$ (2,091,712)	\$ 1,811,994	\$ 546,049
Information Technology								
1930	Expenditures	\$ 14,301,817	\$ 14,259,950	\$ 4,827,175	\$ (2,034,691)	\$ (6,501,545)	\$ (1,052,236)	\$ 6,156,043
	Revenue	\$ 1,259,139	\$ 1,554,389	\$ 1,310,338	\$ 1,519,534	\$ 1,347,613	\$ 550,000	\$ 2,038,000
	GF Contribution	\$ 13,042,678	\$ 12,705,561	\$ 3,516,837	\$ (3,554,225)	\$ (7,849,158)	\$ (1,602,236)	\$ 4,118,043
District Attorney								
2240	Expenditures	\$ 25,038,490	\$ 26,322,084	\$ 28,315,528	\$ 35,332,700	\$ 37,149,466	\$ 38,098,960	\$ 41,454,016
	Revenue	\$ 16,351,414	\$ 13,170,749	\$ 14,414,844	\$ 14,793,095	\$ 16,824,142	\$ 16,893,462	\$ 19,661,548
	GF Contribution/Fund Balance	\$ 8,687,076	\$ 13,151,335	\$ 13,900,684	\$ 20,539,605	\$ 20,325,324	\$ 21,205,498	\$ 21,792,468
Child Support Services								
2250	Expenditures	\$ 10,429,115	\$ 10,590,050	\$ 10,482,528	\$ 11,020,082	\$ 11,095,444	\$ 11,301,584	\$ 12,163,694
	Revenue	\$ 10,641,081	\$ 10,169,044	\$ 10,178,573	\$ 11,165,477	\$ 11,091,978	\$ 11,219,395	\$ 12,084,859
	GF Contribution	\$ (211,966)	\$ 421,006	\$ 303,955	\$ (145,395)	\$ 3,466	\$ 82,189	\$ 78,835
Public Defender								
2270	Expenditures	\$ 12,926,204	\$ 12,135,080	\$ 14,977,196	\$ 15,425,659	\$ 15,952,229	\$ 19,169,779	\$ 18,962,984
	Revenue	\$ 1,121,086	\$ 1,883,390	\$ 1,289,427	\$ 1,450,569	\$ 2,364,215	\$ 3,277,986	\$ 2,828,026
	GF Contribution/Fund Balance	\$ 11,805,118	\$ 10,251,690	\$ 13,687,769	\$ 13,975,090	\$ 13,588,014	\$ 15,891,793	\$ 16,134,958
Sheriff-Coroner								
2300	Expenditures	\$ 109,831,647	\$ 111,811,340	\$ 119,965,917	\$ 129,273,175	\$ 134,916,529	\$ 151,935,094	\$ 157,734,166
	Revenue	\$ 42,847,951	\$ 42,829,522	\$ 44,748,600	\$ 49,624,283	\$ 51,278,516	\$ 53,406,216	\$ 57,472,935
	GF Contribution/Fund Balance	\$ 66,983,696	\$ 68,981,818	\$ 75,217,317	\$ 79,648,893	\$ 83,638,013	\$ 98,528,878	\$ 100,261,231
Probation								
2550	Expenditures	\$ 62,193,935	\$ 66,242,489	\$ 72,883,428	\$ 75,346,850	\$ 78,273,535	\$ 96,452,110	\$ 101,878,720
	Revenue	\$ 41,361,485	\$ 44,695,603	\$ 47,310,369	\$ 48,374,940	\$ 57,839,285	\$ 69,618,767	\$ 72,051,673
	GF Contribution/Fund Balance	\$ 20,832,450	\$ 21,546,886	\$ 25,573,059	\$ 26,971,911	\$ 20,434,250	\$ 26,833,343	\$ 29,827,047
Agricultural Commissioner								
2810	Expenditures	\$ 10,380,040	\$ 11,191,545	\$ 11,807,673	\$ 11,837,918	\$ 12,967,003	\$ 12,813,092	\$ 13,735,191
	Revenue	\$ 6,907,235	\$ 7,403,708	\$ 7,728,947	\$ 8,527,160	\$ 8,935,519	\$ 8,387,500	\$ 8,715,100
	GF Contribution	\$ 3,472,805	\$ 3,787,837	\$ 4,078,726	\$ 3,310,757	\$ 4,031,484	\$ 4,425,592	\$ 5,020,091
Resource Management Agency								
3000	Expenditures	\$ 145,285,045	\$ 129,022,787	\$ 113,464,494	\$ 106,083,025	\$ -		
	Revenue	\$ 99,120,117	\$ 119,068,982	\$ 148,745,009	\$ 77,563,327	\$ 282,414		
	GF Contribution/Fund Balance	\$ 46,164,928	\$ 9,953,805	\$ (35,280,515)	\$ 28,519,698	\$ (282,414)		
Housing & Community Development								
3100	Expenditures					\$ 17,967,033	\$ 25,897,844	\$ 27,975,050
	Revenue					\$ 12,690,815	\$ 15,321,614	\$ 15,024,398
	GF Contribution/Fund Balance					\$ 5,276,218	\$ 10,576,230	\$ 12,950,652

Three Year Forecast

Department		FY 2017-18 Actual	FY 2018-19 Actual	FY 2019-20 Actual	FY 2020-21 Actual	FY 2021-22 Actual	FY 2022-23 Estimated	FY 2023-24 Recommended
Public Works, Facilities, & Parks 3200	Expenditures					\$ 84,599,990	\$ 161,921,791	\$ 163,093,448
	Revenue					\$ 74,853,506	\$ 145,140,220	\$ 128,559,882
	GF Contribution/Fund Balance					\$ 9,746,484	\$ 16,781,571	\$ 34,533,566
Health 4000	Expenditures	\$ 226,943,008	\$ 250,118,036	\$ 259,802,463	\$ 270,764,675	\$ 295,664,619	\$ 315,075,106	\$ 370,806,768
	Revenue	\$ 251,039,616	\$ 241,460,912	\$ 246,239,510	\$ 278,371,387	\$ 306,615,153	\$ 291,261,239	\$ 331,911,544
	GF Contribution/Fund Balance	\$ (24,096,608)	\$ 8,657,124	\$ 13,562,953	\$ (7,606,712)	\$ (10,950,534)	\$ 23,813,867	\$ 38,895,224
Social Services 5010	Expenditures	\$ 256,966,277	\$ 260,516,702	\$ 262,561,621	\$ 265,397,449	\$ 313,618,502	\$ 317,736,610	\$ 332,900,923
	Revenue	\$ 246,843,815	\$ 245,491,881	\$ 248,404,753	\$ 262,279,189	\$ 292,854,370	\$ 298,708,019	\$ 304,488,440
	GF Contribution/Fund Balance	\$ 10,122,462	\$ 15,024,821	\$ 14,156,868	\$ 3,118,260	\$ 20,764,132	\$ 19,028,591	\$ 28,412,483
Library 6110	Expenditures	\$ 8,407,297	\$ 9,159,522	\$ 9,396,171	\$ 9,528,605	\$ 10,484,222	\$ 12,362,296	\$ 11,410,580
	Revenue	\$ 9,269,292	\$ 10,021,707	\$ 11,002,106	\$ 11,427,034	\$ 11,375,893	\$ 12,933,540	\$ 11,644,157
	Fund Balance	\$ (861,995)	\$ (862,185)	\$ (1,605,935)	\$ (1,898,429)	\$ (891,671)	\$ (571,244)	\$ (233,577)
Cooperative Extension Service 6210	Expenditures	\$ 388,261	\$ 317,288	\$ 421,662	\$ 465,109	\$ 405,970	\$ 483,854	\$ 493,894
	Revenue	\$ 5,249	\$ 16,471	\$ 9,078	\$ 1,292	\$ -	\$ 16,645	\$ 26,463
	GF Contribution	\$ 383,012	\$ 300,817	\$ 412,584	\$ 463,817	\$ 405,970	\$ 467,209	\$ 467,431
Parks 7500	Expenditures	\$ -	\$ 12,350					
	Revenue	\$ 649,409	\$ -					
	GF Contribution/Fund Balance	\$ (649,409)	\$ 12,350					
Natividad Medical Center 9600	Expenditures	\$ 406,003,584	\$ 419,041,137	\$ 574,278,014	\$ 581,044,407	\$ 439,004,321	\$ 389,527,072	\$ 419,347,035
	Revenue	\$ 509,836,533	\$ 589,880,809	\$ 597,516,658	\$ 644,230,812	\$ 493,593,551	\$ 404,393,676	\$ 422,886,422
	Net Position	\$ (103,832,949)	\$ (170,839,672)	\$ (23,238,644)	\$ (63,186,405)	\$ (54,589,230)	\$ (14,866,604)	\$ (3,539,387)
Countywide Totals	Expenditures	\$1,590,428,173	\$1,509,024,013	\$1,712,254,532	\$1,764,938,629	\$1,650,167,746	\$ 1,787,752,359	\$ 1,886,640,297
	Revenue	\$1,719,269,908	\$1,719,604,539	\$1,804,758,665	\$1,916,108,974	\$1,812,491,816	\$ 1,793,616,032	\$ 1,848,732,609
	GF Contribution/Fund Balance	\$ (128,841,735)	\$ (210,580,526)	\$ (92,504,133)	\$ (151,170,345)	\$ (162,324,071)	\$ (5,863,673)	\$ 37,907,688

Effective FY 2016-17, Resource Management Agency (RMA) reorganized its reporting structure. Expenditures & Revenues are now reported at the division level.

Effective FY 2017-18, Parks falls under the Resource Management Agency (RMA).

Effective FY 2017-18, the Equal Opportunity Office was renamed Civil Rights Office.

Effective FY 2019-20, Economic Development was reorganized and now falls under the County Administrative Office (CAO) and RMA.

Effective FY 2021-22, the Resource Management Agency (RMA) was dissolved and the Public, Works, Facilities & Parks Department and the Housing & Community Development Department were formed.

Effective FY 2023-24, the Department of Emergency Management was formed.

Strategic Initiatives

Monterey County Strategic Initiatives

Overview

Monterey County's strategic initiatives are one element of an integrated management system focused on understanding how well programs and services are meeting defined goals with the resources provided by County, State and Federal funds. This system links together four previously separate efforts by the County to understand and evaluate programmatic performance.



Each element of this integrated management system provides critical information for County officials, staff and the public.

- **Strategic initiatives** are set by the Board of Supervisors. They establish overarching priorities for the County and provide direction to departments during the budget development process.
- **Department Operational Goals** are developed at the department level as part of the annual budget development process. They align with the Board of Supervisors' strategic initiatives.
- **Programs and services** are delivered by County staff. They are designed and budgeted in accordance with established budget goals.
- **Performance measures** provide a framework to assess County programs and services in relation to the Board's strategic initiatives. Department directors, managers and supervisors use performance data on an ongoing basis to manage for results and improve programs.



ECONOMIC DEVELOPMENT

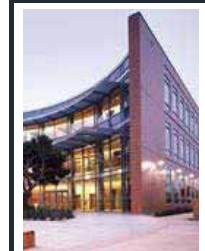

ADMINISTRATION



HEALTH AND HUMAN SERVICES



INFRASTRUCTURE



PUBLIC SAFETY

Strategic Initiatives

Policy Area	Strategic Initiative
Economic Development <i>“Enhancing the well-being and prosperity of Monterey County Residents”</i>	Through collaboration, strengthen economic development to ensure a diversified and healthy economy.
Administration <i>“Efficient and Effective Government Operations”</i>	Promote an organization that practices efficient and effective resource management and is recognized for responsiveness, strong customer orientation, accountability and transparency.
Health and Human Services <i>“Health and Wellness for Monterey County Residents”</i>	Improve health and quality of life through County supported policies, programs, and services; promoting access to equitable opportunities for healthy choices and healthy environments in collaboration with communities.
Infrastructure <i>“Meeting our Facilities, Water, Technology and Transportation Needs”</i>	Plan and develop a sustainable, physical infrastructure that improves the quality of life for County residents and supports economic development results.
Public Safety <i>“Creating Safe Communities”</i>	Create a safe environment for people to achieve their potential, leading businesses and communities to thrive and grow while reducing violent crimes.

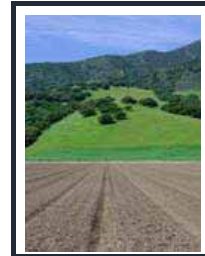

ECONOMIC DEVELOPMENT



ADMINISTRATION



HEALTH AND HUMAN SERVICES



INFRASTRUCTURE



PUBLIC SAFETY

Key Objectives for Strategic Initiatives

Economic Development

- Create better paying jobs, reduce poverty and increase the revenue base through business expansion while adding to the economic vitality of the County.

Administration

- Achieve a balanced budget each year that sustains core services and efficiently allocates resources.
- Recruit and retain a diverse, talented workforce that supports the mission of Monterey County.
- Foster innovation in order to improve efficiency and effectiveness of County services.

Health and Human Services

- Reduce regional, socio-economic inequities in health outcomes.
- Improve health outcomes through healthy and wellness promotion and access to top quality healthcare.
- Advocate for a sufficient allocation of funds from the state and federal governments that will enable the County to carry out its authorized health care programs.

Infrastructure

- Improve the conditions of County roads and bridges.
- Promote the use of best environmental practices for County facilities and operations.
- Provide for adequate County facilities and infrastructure.
- Protect water quality and provide for adequate water supply.

Public Safety

- Create and sustain a comprehensive approach to reducing violence.
- Attain safe and appropriate facilities to house adult and juvenile offenders that prepare them for successful re-entry to society.
- Engage public safety stakeholders, partners, and whole community in resiliency building activities including emergency reporting, disaster preparedness, mitigation response and recovery.



ECONOMIC DEVELOPMENT

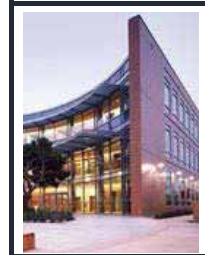

ADMINISTRATION



HEALTH AND HUMAN SERVICES



INFRASTRUCTURE



PUBLIC SAFETY

Strategic Initiatives



This page intentionally left blank.

General Financial Policies

1. PURPOSE AND BACKGROUND

The stewardship of public funds is one of the most significant responsibilities given to the officials and managers of the County of Monterey (County). The development and maintenance of prudent financial policies enable County officials to protect public interests, ensure transparency, and build trust. Financial policies define a shared understanding of how the County develops its financial practices and manages its resources to provide the best value to the community.

This document centralizes the County's financial policies to establish a framework for overall fiscal planning, management, and guidance. These policies are reviewed, updated, and brought before the Board of Supervisors (Board) as needed but at least annually for adoption. This continued review and adoption promotes sound financial management and helps maintain the County's stability, efficiency, and effectiveness by ensuring the Board's financial guidance is provided before all County actions. The policies also offer guidelines for evaluating both current activities and proposals for future programs and direct the County's financial resources toward meeting its objectives and strategic initiatives.

The policies provide general guidance in the management of the County's fiscal affairs and are to be used by all County departments to meet their obligation to operate in a financially prudent manner. The Recommended Budget adheres to these policies.

2. GENERAL FINANCIAL PHILOSOPHY

The financial policies provide a sufficient financial base and the resources necessary to support and sustain an adequate and responsible community service level to ensure public safety, enhance the physical infrastructure and environment, and improve and maintain the quality of life within our community.

The cornerstone and highest priority of the County's financial policies is fiscal integrity. It shall be the goal of the County to achieve a strong financial condition with the ability to:

- a. Sustain adequate financial liquidity to meet normal operating and contingent obligations;
- b. Provide an acceptable level of medical, social, law enforcement, and other protective services to assure public health and safety;
- c. Ensure a sufficient financial base is maintained to withstand local and regional economic impacts;
- d. Prudently plan, coordinate, review, and implement responsible community development and growth;
- e. Foster the ability to adjust efficiently to the community's changing service requirements;
- f. Maintain and improve infrastructure and capital assets;
- g. Regularly review programs and operational methods to improve processes that result in higher productivity, eliminate repetitive and duplicative functions;
- h. Encourage collaboration with other government entities, the private sector, and public-private partnerships where cost and risk are minimized in the delivery of services within the community;
- i. Promote equitable sharing of costs by service users;
- j. Ensure the legal use of financial resources through effective systems of internal controls;
- k. Support sound financial management by providing accurate and timely information on the County's financial condition; and
- l. Provide a framework for the wise and prudent use of debt financing and maintain a good credit rating in the financial community.

2.1 The Annual Budget

- a. The County Administrative Office will recommend a balanced budget that aligns annual expenditures with conservative revenue estimates to minimize the use of fund balance or other one-time financing sources for ongoing operating expenditures;

- b. The County Administrative Office will consult with Department Heads and seek their input in developing the Recommended Budget through cooperative discussions and budget workshops;
- c. The County Administrative Office will keep the Board apprised on the condition of the County's finances and emerging fiscal issues; and
- d. Through the Board's Legislative Committee, the County will work with the California State Association of Counties (CSAC), state representatives, legislative advocates in the State Capitol, and other local government organizations to assure any state programs administered by the County are adequately funded and any realignment of state and county responsibilities are fiscally neutral.

3. ROLES AND FUNCTIONS

3.1 Role of County Administrative Office

The County Administrative Office serves as the chief policy advisor to the County Administrative Officer and the Board. The County Administrative Office promotes responsible resource allocation, strives to protect the County's financial position and integrity, and provides independent analysis on policy issues. The County Administrative Officer is the fund manager for the General Fund and all other funds, and on behalf of the Board, the County Administrative Officer makes independent recommendations regarding all additional funds under their jurisdiction.

3.2 Principal Functions of the County Administrative Office

Principal functions of the County Administrative Office include:

- a. Promoting continuous improvement of the structures, systems, processes, and effectiveness of programs;
- b. Preparing the annual financial plan (Recommended Budget);
- c. Working with departments to evaluate potential federal, state, and local budget impacts;
- d. Developing financial forecasts;
- e. Monitoring revenues and expenditures for conformance with the annual budget;
- f. Recommending effective fiscal policies to carry out programs;
- g. Verifying Board policies are consistently applied; and
- h. Ensuring items brought before the Board are accurate, complete, fully justified, and reviewed by appropriate stakeholders.

3.3 Principal Functions of County Departments

Departments are considered the content experts for the functions they perform. They are responsible for:

- a. Carrying out operations efficiently and cost-effectively while adhering to all county, state, and federal laws, regulations, and policies;
- b. Preparing budgets and financial estimates with attention to accuracy based on their operational expertise, county, state, and federal funding changes, and economic indicators affecting revenues, expenditures, and service levels;
- c. Reviewing, evaluating, and assessing potential federal and state budget issues that may impact local budgets;
- d. Developing and performing financial forecasts;
- e. Monitoring monthly revenue and expenditure performance and conformance with the annual budget;
- f. Meeting the Board's strategic initiatives and its policies; and
- g. Ensuring items brought before the Board are transparent, accurate, complete, fully justified, and reviewed by all appropriate stakeholders.

3.4 Principal Functions of the Budget Committee

The Budget Committee's principal functions include receiving staff updates on financial issues affecting the County and providing oversight and direction to staff in developing and modifying the budget.

3.5 Principal Functions of the Capital Improvement Committee

The Capital Improvement Committee's principal functions are to review the status of projects and establish a priority between competing needs.

4. SERVICES AND FUND STRUCTURE

4.1 General Fund

The County provides a broad range of mandated and non-mandated government services. The cost of these services is accounted for in the General Fund, the County's largest single fund. The General Fund is used to account for revenues and expenditures unless another fund has been created to account for a specific item, activity, or program.

4.2 Other Funds

Other governmental and proprietary funds that account for activities not provided by the General Fund are described below.

Other Governmental Funds

- a. Special revenue funds are used to account for proceeds and expenditures from specific revenue sources to finance designated activities required by statute, regulation, ordinance, resolution, or board order.
- b. Debt service funds are used to provide repayment of debt, such as Certificates of Participation (COPs), short-term borrowing, and other obligations.
- c. Capital project funds are used for capital improvements and specified capital projects.

Proprietary Funds

- a. Enterprise funds are financed and operated like private business enterprises whose services are primarily funded through user charges.
- b. Internal service funds are used to account for any activity that provides goods or services to other funds, departments, or agencies of the County.

4.3 Major Funds

The County Administrative Officer or designee shall have the authority to determine funds that will be considered major funds for financial planning purposes. In addition to significant appropriations, factors that may be considered when designating major funds include political/social sensitivity of the activities financed from that fund, impact or potential impact of that fund on other programs or services, the significance of that fund on financing activities which are of high interest to the County and the public, and the existence of known uses or users of that information (e.g., bond rating companies, investors).

Major funds are as follows, but not limited to: 1) General Fund; 2) Natividad; 3) Facility Master Plan Projects; 4) Road Fund; 5) Library Fund; 6) Behavioral Health Fund; 7) Health and Welfare Realignment Fund; 8) Local Revenue Fund; and 9) Laguna Seca Recreation Area Fund.

5. OPERATING BUDGET

5.1 The County Budget

The Recommended Budget is the central financial planning document that embodies all County departments' goals, objectives, priorities, levels of service, and the associated operating revenue and expenditures. Appropriation authority is granted on the relationship between expected expenditures and revenue; therefore, appropriation authority is granted contingent on this relationship meeting the Recommended Budget. If revenues fall below expected amounts, the department must take all actions available to reestablish a revenue and expenditure relationship that conforms to the Recommended Budget.

The Recommended Budget shall be presented to the Board for adoption in June of each year and presented clearly for a general audience of the public. The Recommended Budget may be modified as approved by the Board during the fiscal year.

5.2 Balanced Budget

The County must adopt a *statutorily* balanced budget. A budget is *statutorily* balanced when the total estimated financing sources (beginning fund balance plus revenues) equal the total appropriation (expenditures plus ending fund balance). At no time shall spending in a given year exceed total current revenues plus any fund balance carryover from the prior year.

In addition to adopting a *statutorily* balanced budget, the County ensures the ongoing sustainability of its services by producing a *structurally* balanced budget. A *structurally* balanced budget matches total ongoing expenditures to the annual estimated revenues. In a *structurally* balanced budget, beginning fund balance may not be used as a financing source for ongoing expenditures. Departments have a fiscal objective to avoid using fund balance for operating purposes by aligning annual operating expenditures with annual operating revenues.

5.3 Ongoing Maintenance and Operations Needs

The County will adequately fund ongoing maintenance and operational needs with ongoing annual revenue. Without prior direction and approval by the Board and its Budget Committee, the use of one-time revenues or short-term borrowing is not allowed as a resource to finance ongoing maintenance and operational needs.

5.4 Adequate Maintenance of Capital Facilities and Equipment

The County shall establish as a primary fiscal responsibility the preservation, maintenance, future improvement and, when applicable, orderly replacement of the County's capital facilities and equipment.

5.5 CalPERS

The annual budget will provide adequate funding for all retirement systems. The County contracts with the California Public Employees' Retirement System (CalPERS) to provide retirement benefits under their defined benefit program. As a participant, the County is required to annually fund at a minimum the cost for retiree health benefits, otherwise known as Other Post-Employment Benefits (OPEB). To provide long-term funding for this benefit, the Board authorized joining CalPERS' California Employers' Retiree Benefit Trust (CERBT) and the pre-funding of the County's OPEB liabilities.

Due to its length, the Pension Liability Policy is separate from these policies and available [online](#).

5.6 Budget Deficits

Departments estimating a budget deficit shall prepare and submit a report to the Budget Committee that outlines the cause of the problem, the alternatives available to mitigate the projected budget deficit, and the department's recommended action. All additions to appropriations, transfers between funds, major plans to reduce service

levels, or plans to request funding from the contingencies appropriation require approval by at least four Board members (4/5ths vote).

5.7 Appropriations and Transfers

The following policy establishes appropriation control at the appropriation unit level, per Section 29120 of the California Government Code. The County Administrative Officer, per Section 29092 of the California Government Code, is the designated administrator over appropriation control, which includes transfers and revisions of appropriations that do not result in an overall increase in appropriations for an appropriation unit.

After budget adoption, a department may request a transfer between major expense categories within the same appropriation unit. The County Administrative Officer has designated authority to approve moves between major expense categories. Examples of major expense categories include salary and employee benefits, services and supplies, and other financing uses. Departments can only request a transfer between major expense categories within the same appropriation unit. The County Administrative Office must approve the request to transfer between major expense categories.

Transfers of appropriations between appropriation units must be approved by Board resolution. Per Section 29125 (a) of the California Government Code, operating transfers in and out between funds are not a transfer of appropriations, as, per Section 29089 of the County Budget Act, transfers out by fund are specified in the budget and are adopted by resolution.

5.8 Responsibility for Budget Management and Budgetary Control

The County shall maintain a budgetary control system to help it adhere to the budget. The County Administrative Office has budgetary control and authority over appropriations. The Auditor-Controller shall administer and maintain the system utilized for budgetary control. As the administrator of the budgetary control system, the Auditor-Controller shall notify the County Administrative Office when a department is reaching an appropriation limit. The Auditor-Controller shall seek guidance from the County Administrative Office on all issues relating to appropriation limits and controls.

County Officers and Department Heads have primary responsibility for managing departmental budgets by:

- a. Providing accurate and timely budget estimates;
- b. Monitoring revenues to ensure timely receipt in the amounts anticipated;
- c. Ensuring that expenditures comply with the law, adopted resolutions, policies, and align appropriations relative to revenues;
- d. Providing prompt notification to the County Administrative Office when either revenues or expenditures are not as anticipated; and
- e. Preparing and justifying budget revisions when necessary.

5.9 Preparation of Financial Reports

The County Administrative Office annually prepares:

- a. A Budget End-of-Year Report (BEYR) to retrospectively report on actual financial performance at a detail and summary level;
- b. A current year estimate and three-year forecast to provide current year performance and forward-looking perspective to advise the Board on future challenges and provide a base for building the following year's Recommended Budget; and
- c. Additional reports, as appropriate, to keep the Board informed on current financial performance and developments.

The Auditor-Controller's Office annually prepares:

- a. An Annual Comprehensive Financial Report (ACFR) as required by the state, that reports on the County's financial position and activities beyond Generally Accepted Accounting Principles (GAAP) or state law requirements, to provide readers with a broader understanding of financial operations;
- b. A Single Audit that reports federally funded County activities, in compliance with the U.S. Office of Management and Budget Circular A-133 Compliance Supplement, to assure the County's adherence to laws, regulations, contracts, and grants applicable to its major federal programs;
- c. A Cost Allocation Plan (COWCAP) schedule, as required by the Federal Management Circular A-87 "Cost Principles for State and Local Governments", that confirms and allocates the indirect costs of the County to operating and non-general county departments; and
- d. The countywide annual Tax Rate Book.

The County Administrative Office has oversight and contract management over the external auditors reviewing the ACFR. External auditors shall report to the County Administrative Office on audit findings. The County Administrative Office will take audit findings thereafter to the Board.

5.10 Publication of Budget

The County Administrative Office shall publish annually a Recommended Budget document that satisfies nationally recognized standards for effective budget presentation. The Auditor-Controller shall annually publish an adopted budget document to meet State Controller's Office requirements.

5.11 County Budget Development

Budget development is an annual process incorporating the Board's priorities and weighing competing requests for County resources within expected fiscal constraints. The process begins with departments preparing "baseline" budgets proposing levels of service and staffing that can be carried out within expected resources (e.g., program revenues and general fund contributions). To the extent there are increased costs or reduced revenue, baseline budgets may indicate potential reductions in staffing or services to maintain budgetary balance if additional resources are not provided. Departments may submit "augmentation requests" for additional resources to mitigate potential impacts, increase staffing/services, or invest in infrastructure. The County Administrative Office evaluates baseline budgets and augmentation requests within the constraints of a balanced budget and builds the annual Recommended Budget. Staff considers the following criteria in formulating recommendations for the annual budget and subsequent mid-year budget modifications:

- a. Mandated by current law or Board policy;
- b. Alignment with the County's strategic initiatives and priorities;
- c. Consistent with community priorities expressed in forums, surveys, and other community engagement initiatives;
- d. Necessary to maintain the current level of mission-critical services/operations;
- e. Substantiation of compelling public need (e.g., health, safety, economic vitality, quality of life) that cannot be met within existing resources;
- f. Likelihood of success based on prior performance, degree of planning/specificity, requested resources, and assumed timeline;
- g. Leverages sustainable financial support from non-County sources;
- h. Appropriate placement of responsibility (federal, state, or local);
- i. Degree of urgency; and
- j. Critical infrastructure investment to ensure productivity and continuity of operations.

Criteria in the listing are not exhaustive or in any particular order, nor are they mutually exclusive; funding recommendations may align with more than one criteria.

5.12 Establish Countywide Priorities

The Board has a continuous process of establishing countywide priorities for ensuing years. The Board implements these priorities in the Recommended Budget within the framework of the law. Understanding that elected officials and Department Heads are charged with the actual provision of services to the community, the Board shall set broad priorities to ensure flexibility for departments to concentrate on these priorities.

5.13 Authorization of Elected Officials

In determining service levels, the Board and County Administrative Office recognize that countywide elected officials have constitutional and/or statutorily created mandates and are accountable to the electorate. Although the Board adopts a budget for each department, elected officials will determine the services they will provide within the adopted budgetary constraints. These policies recognize that elected officials have independent constitutional and/or statutory powers to direct service levels and priorities within their departments. These powers are independent of the Board in part because these officials (like the Board) serve at the pleasure of the electorate. However, the Board is responsible for allocating appropriations to all departments.

5.14 Budget Adoption Level

Under the County Budget Act (California Government Code, Sections 29000 through 29144), the Board enacts the annual financial plan (the Adopted Budget) through the passage of a resolution. The resolution mandates the maximum authorized expenditures for the fiscal year and sets appropriation control at the appropriation unit level. An appropriation unit represents one or more budget units and defines the budgetary limits of those budget units. A budget unit represents a program or group of programs providing a similar service. The assignment of an appropriation unit is guided by State Controller financial reporting requirements and/or County requirements. Pursuant to Section 29092 of the County Budget Act, the County Administrative Office is charged by the Board to monitor and make administrative decisions related to appropriation control.

5.15 Amendments to the Adopted Budget

Modifications to the Adopted Budget require approval by at least four Board members (4/5ths vote). Amendments to the Adopted Budget will be made in compliance with Board policies.

5.16 Budgetary Basis

The County uses the modified accrual basis of accounting following Generally Accepted Accounting Principles (GAAP). The budgetary basis is substantially the same as the modified accrual method of accounting that is used for financial reporting for all governmental funds except enterprise funds. The County currently has three enterprise funds which are budgeted based on a full accrual basis of accounting.

5.17 Capital Asset Definition

The County defines capital assets as assets with initial, individual costs of \$5,000 or more and an estimated useful life greater than one year, except infrastructure, for which the threshold is set at \$100,000. Capital assets include both tangible and intangible assets categorized by asset type for reporting purposes.

6. STRATEGIC PLANNING

6.1 Three-Year Forecast

The County uses a Three-Year Forecast strategic model to develop, initiate, and modify policies and budgets. The Three-Year Forecast demonstrates the County's ability to accomplish long-term goals by determining the potential

budgetary impacts of current budget decisions. This approach allows the Board to be aware of the probable long-term outcomes of alternative decisions and to select the one that effectively serves the interests of the community within the financial resources of the County.

The Three-Year Forecast identifies fund balances, revenue patterns, expenditure trends, and cash requirements. It is neither a future budget, nor does it recommend services or programs. The Forecast is a guide to assist in making recommendations and building future budgets. The Forecast is designed to facilitate decision-making based on two fundamental questions: "What is the County's financial future without change?" and "What path does the County wish to take for the future?"

The annual Three-Year Forecast is prepared in February by the County Administrative Office, with the subject matter expert assistance of departments. The timeframe allows departments to obtain prior year audited results and six months of actual financial data in the current fiscal year. The Forecast serves as a current year estimate and three-year financial outlook for building next year's Recommended Budget.

7. REVENUE AND EXPENDITURE POLICIES

7.1 Revenue Diversification

A diversified and stable revenue system will be maintained to shelter community services from short and long-term fluctuations to the extent possible.

7.2 Revenue Estimates

Annual revenues are conservatively estimated as a basis for preparing the Recommended Budget. Estimates shall not be based on optimistically hoped-for events but analytical techniques that use historical data, economic trends and indicators, information available from the state and other governmental agencies, and other accepted standards. In general, revenue estimates shall not assume any growth rate that is not well documented. Real growth that occurs beyond budgeted revenue will be recognized through budgetary adjustments. Significant revenues will be estimated by the department that manages the program and then reviewed first by the County Administrative Office and subsequently by the Board's Budget Committee before the adoption of the Recommended Budget.

7.3 Current Revenues

Annual expenditures shall be balanced to ongoing annual revenues without the use of one-time financing. Deficit financing and borrowing will not be used to support ongoing County services and operations without explicit Board direction and approval. The Board shall be advised that interfund loans are required, or the use of non-appropriated funds is requested.

7.4 User Fees

The County charges user fees for various services when it is appropriate and permitted by law. Unless set by policy, regulation, or statute, user fees are established and maintained at the Board's discretion. Fees will generally be set at a level sufficient to cover both direct and indirect costs of the services provided. The service may be subsidized by the County as deemed necessary by the Board. Factors for subsidy consideration include whether a subsidy causes an inappropriate burden on taxpayers, the degree to which the service benefits a segment of the population, whether beneficiaries can pay the fee, and whether the service provides a broader benefit to the community.

All fees for services are reviewed as necessary and adjusted where appropriate. The full cost of providing a service is calculated to provide a basis for setting the charge or fee and incorporates direct and indirect costs, including

operations and maintenance, overhead, charges for the use of capital facilities, as well as depreciation. Other factors for fee or charge adjustments may include the impact of inflation, other cost increases, the adequacy of the coverage of costs, current competitive rates, and contractual or statutory restrictions. Part of the decision-making process in establishing new services or increasing service levels should include an analysis of fees and user charges and a desired cost-recovery threshold. Increases may be justified based on outside variables not considered during the baseline budget submissions (e.g., water levels, gas prices, economy).

7.5 One-Time Revenues

The use of one-time revenues for ongoing expenditures is discouraged. Unpredictable revenues are budgeted conservatively, and any amount collected over the budget is generally carried forward in the fund balance.

7.6 Revenues of a Limited or Indefinite Term

Revenues of a limited or indefinite term will generally be used for those limited or unlimited term functions associated with the revenue. If it cannot be done, the revenue is to be considered discretionary revenue. It may be used for one-time expenditures to ensure no ongoing service programs are lost when such revenues are reduced or discontinued.

7.7 Use of Discretionary General Fund Revenue

Departments shall maximize the use of non-General Fund discretionary revenue and minimize the need to use discretionary General Fund revenue to fund programs. The Board will prioritize the use of discretionary General Fund revenue through the annual budget process.

7.8 Maintaining Revenue and Expenditure Categories

The County will maintain revenue and expenditure categories per state statute and administrative regulation and operational needs.

7.9 Outside Organization Contributions

Public Safety Sales Tax (Proposition 172)

Government Code Section 30052 requires Proposition 172 funds be placed into a special revenue fund and expended on such public safety services as sheriffs, fire, county district attorneys, and corrections.

The County has historically shared its Proposition 172 revenues with other agencies to help fund fire districts and offset costs to cities for emergency dispatch services. In the event of fiscal constraints, the Board retains the authority to reduce allocations to other agencies upon findings that internal public safety programs would otherwise require program reductions. The County Administrative Office is charged with determining when a reduction to other agencies would be appropriate and obtaining authorization from the Board to begin those discussions.

Emergency Communications Users' Offset

The Emergency Communications Department receives five percent (5%) of Proposition 172 revenues. The current agreement with user agencies fixed their funding at five percent (5%) of the County's total Proposition 172 revenues for the most recently audited fiscal year (e.g., the FY 2023-24 allocation will be five percent (5%) of FY 2021-22 audited actuals). Overall, ten percent (10%) of Proposition 172 revenues are distributed for emergency communication operations.

Fire Agencies' Distribution

The County shares with the Association of Firefighters and Volunteer Fire Companies 9.13% of the County's Proposition 172 revenue of the most recently audited fiscal year. The various fire agencies allocate the Proposition 172 revenue amongst themselves via their own allocation formula.

Distributions to Sheriff, Probation, and District Attorney

After allocation to local fire agencies and Emergency Communications, 80.87% percent of Proposition 172 revenues are distributed to the Sheriff, Probation, and District Attorney departments as approved by the Board in the base year of FY 1995-96, with growth revenues distributed using the percentages listed below:

<u>Department</u>	<u>% of Growth</u>
Sheriff	61.2%
District Attorney	21.7%
Probation	<u>17.1%</u>

County Agency Distribution

The State Board of Equalization apportions Proposition 172 revenues to each county based on its proportionate share of statewide taxable sales. Due to the disbursement cycle of Proposition 172 revenues from the State Controller, each fiscal year's actual Proposition 172 revenues are not known until August of the following fiscal year.

Proposition 172 Distribution Formula

<u>Agency</u>	<u>Prop. 172 Distribution</u>
Local Fire Agencies	9.13%
Emergency Communications	10.0%
Other Public Safety County Departments	<u>80.87%</u>

Contributions from Transient Occupancy Tax (TOT)

Contributions to Economic Development Set Aside

The County has agreed to annual contributions to the Monterey County Convention and Visitors Bureau, Film Commission, and Arts Council, respecting the value these organizations add to the community and their role related to the County Transient Occupancy Tax (TOT) revenues. This contribution is based on a shared percentage of total TOT revenues from the previously audited fiscal year. The Convention and Visitors Bureau receives a contribution equal to 6.00%, the Film Commission receives a contribution equal to 0.95%, and the Arts Council receives a contribution equal to 1.98%, totaling a combined 8.93% contribution from the County's TOT revenues. In the event of fiscal constraints, the Board retains the authority to reduce its allocation to these outside agencies upon findings that internal countywide priority programs would otherwise require program reductions. The County Administrative Office is charged with determining when a reduction to outside agencies would be appropriate and obtaining authorization from the Board to begin those discussions.

Contributions to the Road Fund

In FY 2013-14, the TOT contribution percentage for the Road Fund was established by the Board at twenty percent (20%) of total TOT revenue. Per annum, the contribution shall increase by one percent (1%) until it reaches a twenty-five percent cap (25%). This contribution replaces, and is not in addition to, the \$2.0 million the County previously provided per annum to the Road Fund from the General Fund.

Annual Contributions

Organizations that are not part of the County, but receive contributions from the County, shall not have their appropriation carried forward from budget-cycle to budget-cycle unless authorized and directed by the Board. At

the will of the Board, organizations receiving County contributions may be subject to annual review and presentation to the Board on the value and services provided to the community as a result of County funds.

7.10 Appropriations for Contingencies

The County annually adopts an appropriation for contingencies to provide sufficient working capital and a margin of safety for unplanned operational needs. The contingency appropriation may be used at the discretion of and by the action of the Board. The contingency appropriation is utilized only after all other budget resources have been examined. The appropriation for operational contingencies shall be equal to one percent (1%) of estimated General Fund revenues unless expressly modified by the Board as part of the annual budget adoption.

7.11 Performance Measures

Departments shall develop key performance measures that address best practices, desired outcomes, Board strategic initiatives, and annual goals to ensure resource optimization and maximize results. Departments will pursue the most cost-effective means to achieve their performance measures. Performance measures provide the criteria that the Board and management uses to evaluate departmental requests for funding.

7.12 Payment for Goods from Prior Year

Goods and services ordered but not received before the end of the prior fiscal year will be paid from the current year's budgeted appropriations. The department's payment for goods and services to be received or used in the next year are not authorized for payment from current year funds, unless the items are dues or maintenance agreements where recurring invoices for the next year are generally due before year-end.

8. FUND BALANCE AND RESERVE POLICIES

8.1 Use of Year-End Fund Balance

The fund balance is a measurement of available financial resources. It is the difference between total assets and total liabilities in each fund. The Board recognizes that the maintenance of fund balance is essential to preserving the County's financial integrity. The County's goal is to use fund balance as a source to finance one-time investments, reserves, and/or commitments. As a one-time financing source, any unbudgeted year-end fund balance will be used for non-recurring expenditures and only after the yearly audit and confirmation of the General Fund's fund balance.

Governmental Accounting Standards Board (GASB) Statement 54 distinguishes fund balance based on the relative strength of the constraints that control the purposes for which specified amounts can be spent. Beginning with the most restrictive constraints, fund balance amounts are reported in the following categories:

- a. **Nonspendable fund balance** – amounts that are not in a spendable form (e.g., inventory) or are legally or contractually required to be maintained intact (e.g., permanent fund principal).
- b. **Restricted fund balance** – amounts that can be spent only for the specific purposes stipulated by external parties, either constitutionally or through enabling legislation (e.g., grants or donations).
- c. **Committed fund balance** – amounts that can only be used for the specific purposes determined by a formal action (resolution) of the Board. Commitments may be changed or lifted only by referring to the formal action that imposed the constraint originally (e.g., the Board's commitment in connection with future capital projects).
- d. **Assigned fund balance** – amounts intended to be used for specific purposes. Intent can be expressed by the Board, or the County Administrative Officer, or designee.

- e. **Unassigned fund balance** – includes all amounts not contained in other classifications and is the residual classification of the General Fund only. Unassigned amounts are available for any legal purpose.

8.2 Fund and Reserve Levels

Sufficient fund balance and reserve levels are a critical component of the County's overall financial management strategy. They are key factors in the ability to sustain service delivery and obtain external financing. Rating agencies analyze fund balance when considering the County's overall financial strength and creditworthiness. Adequate reserves enable flexible financial planning in developing future capital projects, dealing with unforeseen emergencies and changes in fiscal conditions. Each fund shall maintain a level of reserves, providing a positive fund balance throughout the fiscal year. In the event a fund anticipates going in a negative cash position, the fund manager shall immediately bring to the Budget Committee a report outlining the reason(s) along with a financial plan to ensure the fund regains a positive cash balance.

The County uses a strategic reserve policy to provide adequate fund balance throughout the year. All major County funds shall develop a reserve policy and fund a reserve in conformance with their industry's best practices. In the event such best practices are non-existent, the fund shall adopt the percentages as follows: an appropriation for operational contingencies equal to one percent (1%) of estimated annual revenue and a strategic reserve equal to ten percent (10%) of estimated annual revenue.

8.3 Committed Fund Balance – Strategic Reserve Fund

The County will commit a portion of the fund balance in the General Fund as a strategic reserve to provide the County with sufficient working capital and be used to fund settlement of legal judgments against the County in excess of reserves normally designated for litigation, for short-term revenue reductions due to economic downturns, for natural disasters as determined by the County Administrative Officer or Board, and for one-time-only state budget reductions that could not be addressed through the annual appropriations for contingencies in the General Fund. The County's goal is to maintain a strategic reserve equal to ten percent (10%) of the General Fund estimated revenues. The Natividad Medical Center (NMC) strategic reserve designation, established in 2011, is a sub-designation of the General Fund strategic reserve.

If the strategic reserve is utilized to provide temporary funding of unforeseen needs, the County shall take measures necessary to prevent its use in the following fiscal year by increasing General Fund revenues and/or decreasing expenditures to regain structural balance. The County shall also restore the strategic reserve to the minimum level of ten percent (10%) of General Fund estimated revenues within five fiscal years following the fiscal year in which the event occurred. The plan to restore the strategic reserve shall be included and highlighted in the County's Three-Year Forecast. Funds in excess of ten percent (10%) of the annual requirements may be retained in the strategic reserve or may be considered for other purposes, such as supplementing capital project funds or prepaying existing debt.

8.4 Order of Expenditure of Fund Balance

When multiple categories of fund balance are available for expenditure (e.g., a project is being funded partly by a grant, funds set aside by the Board, and unassigned fund balance), the County will start with the most restricted category and spend those funds first before moving down to the next fund balance category with available funds.

9. INTERFUND LOANS

Interfund loans are the lending of cash from one County fund to another for a specific purpose and require repayment. Interfund loans are typically short-term in nature and constitute the allocation of cash between individual funds for working capital purposes.

Interfund loans may be made for the following reasons:

- a. To offset timing differences in cash flow;
- b. To offset timing differences between expenditures and reimbursements, typically associated with grant funding;
- c. To provide funds for interim financing in conjunction with obtaining long-term financing; and/or
- d. For short-term borrowing in place of external financing.

Interfund loans are not to be used to solve ongoing structural budget issues or hindering the accomplishment of any function or project for which the lending fund was established. Interfund loans are not to be used from fiscal year to fiscal year as a financing strategy. If a fund has a negative cash balance, the department must present the County Administrative Office with a plan for reaching a positive cash balance. A negative cash balance must be addressed in the fiscal year that the fund reaches negative cash.

Interfund loan monies may only be used for the purpose identified in the authorizing resolution. Appropriate accounting records will be maintained to reflect the balances of loans in every fund affected by such transactions. A summary of all outstanding interfund loans will be included in the Annual Comprehensive Financial Report (ACFR).

9.1 Interfund Loan Terms

The Board must approve interfund loans by resolution. The resolution will include a planned schedule of repayment of the loan principal and set a reasonable interest rate to be paid to the lending fund if required by the lending fund's restrictions or regulations during the time the loan is outstanding. Repayment of an interfund loan shall be within the same fiscal year unless otherwise stated in a Board resolution. The County Administrative Office shall have authority for issuing temporary interfund loans for end-of-year purposes and report out these temporary interfund loans to the Board via memorandum.

9.2 Interfund Loan Interest

The following guidelines should be used in establishing the rate of interest:

- a. Not lower than the "opportunity cost" if the funds were otherwise invested, such as the County Treasury Pooled Interest Rate;
- b. Treasury yields or short-term bond yields for a similar term; and
- c. Not higher than the external rate available to the County.

Interest is not required in the following circumstances:

- a. The borrowing fund has no independent source of revenue other than the lending fund; or
- b. The borrowing fund is generally funded by the lending fund; or
- c. The lending fund is the General Fund, which, being unrestricted, can loan interest-free, except to a proprietary fund (such as one of enterprise funds below).

10. ENTERPRISE FUNDS

The County will establish enterprise funds for County services when:

- a. The fund's operations are financed and operated like private business enterprises, where services provided are primarily funded through user charges; or
- b. The Board determines that it is appropriate to conduct a periodic review of net income for capital maintenance, accountability, or other public policy purposes.

The County Administrative Office is the chief advisor to the Board in the creation of an enterprise fund. The County currently has three enterprise funds: 1) Natividad (fund 451); 2) Lake Resort (fund 452); 3) Laguna Seca Recreational Area (fund 453).

10.1 Expenses

Enterprise fund expenses and revenues will be established at sufficient levels to properly maintain the fund's infrastructure and provide significant capital development without requiring County fiscal intervention.

10.2 Rate Structure and Net Position

Each enterprise fund will maintain an adequate rate structure to cover the cost of all operations, including cash flow, capital replacement and maintenance, debt service if applicable, contingency funding, scheduled reserve contributions, and depreciation. Rates may be offset from the available net position only after these requirements are met.

10.3 Services

Enterprise fund services will establish and maintain reserves for general contingency and capital purposes consistent with those maintained for general governmental services.

10.4 Net Operating Revenues

The County will ensure that net operating revenues of the enterprise are sufficient to pay operating expenses, capital costs, and any debt service requirements where applicable, in compliance with the County's fiscal and debt policies.

10.5 Interest from Funds

Unless otherwise directed by statute, regulation, or resolution, interest will be allocated as discretionary financing for an enterprise fund.

10.6 Financial Monitoring and Reporting

The County Administrative Office and departments shall monitor revenues and expenses throughout the year to ensure conformity to adopted budgets. Enterprise funds shall provide the Budget Committee financial status reports on a semi-annual or quarterly basis. Financial reports shall contain a year-to-date summary of expenses, revenues, and cash positions, significant variances, comparisons to previous fiscal years' activity, trends for the current fiscal year, and financial impacts to the General Fund, if any.

11. INTERNAL SERVICE FUNDS

An internal service fund (ISF) is a centralized governmental service that provides services or products on a cost-reimbursement basis to other governmental units or external users with a break-even motive. To qualify as an ISF, the predominant users of the services or products must be the government itself.

11.1 Use of Internal Service Funds

Risk Management

The Office of the County Counsel is responsible for managing the County's general liability (fund 475) and workers' compensation (fund 476) ISF funds. These ISFs shall function as funds for paying all judgments,

settlements, and claims against the County. The General Liability ISF will reserve adequate funds to cover both excess insured events and events not covered by excess insurance coverage and provide for "recoverable" and "non-recoverable" losses. Both ISFs are currently funded at a seventy percent (70%) confidence level.

Human Resources – Benefits

The Human Resources Department is responsible for managing the County's Benefits ISF (fund 477). The ISF covers various benefit programs supported by contributions from the County, active employees, and retired employees. Programs include dental and vision benefits for employees and dependents, Employee Assistance Program, Long-Term Disability, Retiree Sick Leave Conversion, and other miscellaneous benefit programs.

Resource Planning

The County Administrative Office has administrative authority over all aspects of the Resource Planning ISF (fund 478). The Resources Planning ISF provides funds for capital projects that require replacement, maintenance, or upgrades during the asset's life. The fund serves to establish a capital funding process, generating funds over an asset's life, thereby minimizing fiscal impacts to operations.

The Resource Planning Fund's respective sub-funds are the: 1) VAMP-Vehicle Asset Management Program; 2) ERP-Enterprise Resource Planning for Upgrades/Replacement; 3) BIR-Building Improvement and Replacement; and 4) EIR-Equipment Improvement and Replacement.

11.2 General Fund Transfers

In the event there is a large settlement that cannot be funded within the existing ISF reserve, the Office of the County Counsel may submit a request to the County Administrative Office for a transfer from the General Fund or such other fund as may be available and appropriate. Such a request will include, at a minimum, an analysis of the impact of the settlement on the reserve, alternatives for addressing the implications, and the advantages and disadvantages of each alternative.

11.3 Actuarial Studies

The County Counsel-managed ISFs and the Benefits ISF shall complete two annual actuarial studies. The first study will be completed using data through June 30th, and a second ("true-up") actuarial study will be completed with data through December 31st. The June 30th study will be used to set department allocations for the upcoming fiscal year, while the December 31st study will be used for meeting its operational needs (e.g., purchasing excess insurance coverage). County Counsel will work throughout the year to obtain information on potential settlements that could impact reserve levels and provide this information to the actuary as part of the semi-annual actuarial valuation process.

11.4 Internal Service Funds Reporting

Departments that manage ISFs shall provide to the Board and its Budget Committee an annual report outlining funding levels, operational costs, and outcomes of operations.

12. CAPITAL FACILITIES AND IMPROVEMENT POLICIES

12.1 Capital Investments

The County is responsible for investing in the preservation, maintenance, and improvement of buildings, parks, roads, sewers, equipment, and other capital infrastructure. Strategic capital improvement plans, policies, and programs assess future needs and prevent emergencies to avoid major costs. Thus, the Board established the Capital Improvement Program, Five-Year Plan (CIP), which incorporates into the operating budget the fiscal

impact of projects including design, construction, equipment, land purchases, and administration. The CIP is prepared and updated annually by the Public Works, Facilities, and Parks Department with review by the County Administrative Office.

Projects in excess of \$100,000 that have an estimated useful life of at least five years and are non-recurring should be included in the CIP for consideration and countywide prioritization. Updates will regularly be made to all projects in various stages of implementation within the CIP and annual review of priorities, needs and staffing levels will be conducted. The CIP shall be consistent with the County's overall goals and objectives and coordinated with economic development infrastructure investments.

12.2 Financial Analysis of Funding Sources

Financial analysis of funding sources is conducted for all proposed major capital improvement projects. Operating and maintenance costs should be identified separately, to ensure that adequate funds will be available for ongoing expenses necessary to maximize useful life. The Budget Committee determines available funding sources and provides input toward scope changes to meet any fiscal constraints. Project scope and budget must be defined and submitted to the Board for approval before project funds can be expended.

12.3 Annual Capital Improvement Budget

The Board includes capital project funding during the annual budget process. In general, capital projects that have secured funding to progress in the first year of the CIP will be included in the Recommended Budget. The Board shall determine annual ongoing funding levels for each of the major project categories within the CIP. When considering the priority and funding of each capital project, the County shall consider the operating impacts (e.g., increased staff, facilities maintenance, and outside rentals) of the project.

12.4 Capital Project Reports

Capital projects shall provide the following reports:

- a. Monthly updates of the drawdown schedule for debt-financed projects;
- b. Quarterly reports to the County Administrative Office detailing quarterly forecasts of expenditures for the life of debt-financed projects;
- c. Quarterly updates to the Capital Improvement and Budget committees on implemented capital projects that include the initial approved and modified budgets, expenditures to date, remaining budget and expenditures, original completion date, and if applicable, revised completion date and the phase (in a percentage) the project is toward completion;
- d. Quarterly updates to the Budget Committee on capital funds interest accumulation; and
- e. Semi-annual updates to the Capital Improvement and Budget committees on scheduled and unscheduled maintenance projects.

The County Administrative Office shall provide a quarterly report to the Capital Improvement and Budget committees regarding drawdown schedules for debt-financed projects.

13. DEBT MANAGEMENT

Due to its length and complexity, the Debt Management Policy is reviewed by the Board separately from these policies. The Debt Management Policies are published online: www.co.monterey.ca.us/government/departments-a-h/administrative-office/debt-management.

14. GRANT MANAGEMENT

The County recognizes that grant funding provides significant resources to enhance the ability to provide services and activities not otherwise available. Consideration will be given to whether grant activities further the County's

mission, are part of the core functions of the department, benefit the community, and whether locally generated revenues will be required to support grant activities when grant funding is no longer available. Grants that do not meet these criteria shall be declined.

Departments are responsible for the continuous monitoring of the financial status of grants and compliance with all applicable federal, state, and local regulations, including procurement policies and procedures.

Any position changes related to grant funding must be approved by the Board and adequately classified by Human Resources. Departments are to promptly notify payroll of coding changes needed for those positions being charged to grants since grant codes may change each year.

Departments are responsible for all aspects of the grant process, including planning for grant acquisition, preparing and submitting grant proposals, developing grant implementation plans, managing grant programs, preparing and providing reports to grantors, and adequately closing out grant projects. Department staff and the County Administrative Office will maintain a close working relationship concerning any grant activity to ensure a clear understanding of the project status.

The County manages a variety of programs, which depend on outside grants for partial or full funding. In the event of reductions in such external funding amounts, the program service levels will be reduced, and additional County support shall not be provided to compensate for the decrease in outside funding unless approved and directed by the Board.

15. STATE AND FEDERAL PROGRAMS

The County shall operate state and federal programs based on the level of state funding provided and shall not backfill any state cuts with General Fund resources except when mandated, or local priorities dictate a need for a continuance.



This page intentionally left blank.

Schedules

Schedule 1

County of Monterey All Funds Summary Fiscal Year 2023-24

Fund Name	Total Financing Sources				Total Financing Uses			
	Fund Balance Available	Decreases to Obligated Fund Balance	Additional Financing Sources	Total Financing Sources	Financing Uses	Increases to Obligated Fund Balance	Total Financing Uses	Ending Available Fund Balance
Governmental Funds								
General Fund	4,993,253	11,414,781	836,213,122	852,621,156	847,023,424	-	847,023,424	5,597,732
Special Revenue	306,328,633	-	440,787,796	747,116,429	465,784,513	-	465,784,513	281,331,916
Capital Project	83,381,506	-	34,569,476	117,950,982	47,782,084	-	47,782,084	70,168,898
Total Governmental Funds	\$ 394,703,392	\$ 11,414,781	\$ 1,311,570,394	\$ 1,717,688,567	\$ 1,360,590,021	\$ -	\$ 1,360,590,021	\$ 357,098,546
Other Funds								
Internal Service	70,952,452	-	69,868,355	140,820,807	67,861,646	-	67,861,646	72,959,161
Enterprise	292,240,556	-	443,854,226	736,094,782	430,327,611	-	430,327,611	305,767,171
Special District & Other Agencies								
<i>County Sanitation Districts</i>	1,511,569	-	2,277,461	3,789,030	3,344,922	-	3,344,922	444,108
<i>County Service Areas</i>	12,303,667	-	3,458,675	15,762,342	6,511,927	-	6,511,927	9,250,415
<i>Housing Successor Agencies</i>	2,075,656	-	302,140	2,377,796	355,000	-	355,000	2,022,796
<i>Other Agencies</i>	-	-	15,480,525	15,480,525	15,480,525	-	15,480,525	-
<i>Other Districts</i>	2,511,630	-	1,920,833	4,432,463	2,168,645	-	2,168,645	2,263,818
sub-total Special Districts & Other Agencies	18,402,522	-	23,439,634	41,842,156	27,861,019	-	27,861,019	13,981,137
Total Other Funds	\$ 381,595,530	\$ -	\$ 537,162,215	\$ 918,757,745	\$ 526,050,276	\$ -	\$ 526,050,276	\$ 392,707,469
Total All Funds	\$ 776,298,922	\$ 11,414,781	\$ 1,848,732,609	\$ 2,636,446,312	\$ 1,886,640,297	\$ -	\$ 1,886,640,297	\$ 749,806,015

Schedule 2

County of Monterey Governmental Funds Summary Fiscal Year 2023-24

Fund Code	Fund Name	Total Financing Sources				Total Financing Uses			
		Fund Balance Available	Decreases to Obligated Fund Balance	Additional Financing Sources	Total Financing Sources	Financing Uses	Increases to Obligated Fund Balance	Total Financing Uses	Ending Available Fund Balance
001	General Fund	4,993,253	11,414,781	836,213,122	852,621,156	847,023,424	-	847,023,424	5,597,732
	Total General Fund	\$ 4,993,253	\$ 11,414,781	\$ 836,213,122	\$ 852,621,156	\$ 847,023,424	\$ -	\$ 847,023,424	\$ 5,597,732
	Special Revenue Funds:								
002	Road Fund	21,073,970	-	61,572,791	82,646,761	76,196,989	-	76,196,989	6,449,772
003	Library Fund	5,965,485	-	11,644,157	17,609,642	11,410,580	-	11,410,580	6,199,062
005	In-Home Support Services	91,569	-	1,019,853	1,111,422	1,019,853	-	1,019,853	91,569
006	Fish & Game Propagation Fund	76,364	-	45,029	121,393	51,636	-	51,636	69,757
008	Community Action Partnership	238,328	-	503,733	742,061	503,733	-	503,733	238,328
009	Inclusionary Housing	461,691	-	22,500	484,191	517,575	-	517,575	(33,384)
011	Economic Development Program	1,756,034	-	150,400	1,906,434	1,150,500	-	1,150,500	755,934
013	Community Development Fund	2,462,616	-	4,178,141	6,640,757	7,114,351	-	7,114,351	(473,594)
016	Emergency Medical Service Fund	1,914,367	-	748,900	2,663,267	708,900	-	708,900	1,954,367
021	Workforce Development Board	-	-	10,430,579	10,430,579	10,430,579	-	10,430,579	-
022	Local Revenue Fund 2011	58,906,816	-	93,536,370	152,443,186	97,332,470	-	97,332,470	55,110,716
023	Behavioral Health	58,543,335	-	159,522,461	218,065,796	166,379,440	-	166,379,440	51,686,356
024	Homeland Security	400,612	-	1,151,231	1,551,843	1,151,231	-	1,151,231	400,612
025	H&W Realignment	54,087,895	-	65,360,947	119,448,842	75,220,982	-	75,220,982	44,227,860
026	NGEN Operations & Maintenance	487,480	-	881,062	1,368,542	881,062	-	881,062	487,480
027	County Clerk Recorder	3,210,551	-	426,000	3,636,551	426,000	-	426,000	3,210,551
028	Emergency Communications	2,804,771	-	14,188,933	16,993,704	14,734,982	-	14,734,982	2,258,722
029	Habitat Management Program	13,737,880	-	177,006	13,914,886	253,650	-	253,650	13,661,236
030	Pension Liability	80,108,869	-	15,227,703	95,336,572	300,000	-	300,000	95,036,572
	Total Special Revenue Funds	\$ 306,328,633	\$ -	\$ 440,787,796	\$ 747,116,429	\$ 465,784,513	\$ -	\$ 465,784,513	\$ 281,331,916
	Capital Projects Funds:								
401	Facilities Project Fund	10,403	-	-	10,403	-	-	-	10,403
404	Capital Projects	83,371,102	-	34,569,476	117,940,578	47,782,084	-	47,782,084	70,158,494
405	NGEN Radio Project	1	-	-	1	-	-	-	1
	Total Capital Projects Funds	\$ 83,381,506	\$ -	\$ 34,569,476	\$ 117,950,982	\$ 47,782,084	\$ -	\$ 47,782,084	\$ 70,168,898
	Total Governmental Funds	\$ 394,703,392	\$ -	\$ 1,311,570,394	\$ 1,717,688,567	\$ 1,360,590,021	\$ -	\$ 1,360,590,021	\$ 357,098,546

Schedule 3

County of Monterey
Fund Balance - Governmental Funds
Fiscal Year 2023-24

Fund Name	Total Fund Balance June 30, 2023	Less: Obligated Fund Balances			Fund Balance Available June 30, 2023
		Encumbrances	Nonspendable, Restricted and Committed	Assigned	
1	2	3	4	5	6

General Fund

001 - General Fund	143,356,791	-	109,036,663	29,326,875	4,993,253
Total General Fund	\$ 143,356,791	\$ -	\$ 109,036,663	\$ 29,326,875	\$ 4,993,253

Special Revenue Funds:

002 - Road Fund	21,073,970	-	-	-	21,073,970
003 - County Library Fund	5,965,485	-	-	-	5,965,485
005 - In-Home Support Services	91,569	-	-	-	91,569
006 - Fish and Game Propagation	76,364	-	-	-	76,364
008 - Community Action Partnership	238,328	-	-	-	238,328
009 - Inclusionary Housing	461,691	-	-	-	461,691
011 - Economic Development Program	1,756,034	-	-	-	1,756,034
013 - Community Development	2,462,616	-	-	-	2,462,616
016 - Emergency Medical Service	1,914,367	-	-	-	1,914,367
021 - Workforce Development Board	-	-	-	-	-
022 - Local Revenue Fund 2011	58,906,816	-	-	-	58,906,816
023 - Behavioral Health	58,543,335	-	-	-	58,543,335
024 - Homeland Security	400,612	-	-	-	400,612
025 - H&W Realignment	54,087,895	-	-	-	54,087,895
026 - NGEN Operatins & Maintenance	487,480	-	-	-	487,480
027 - County Clerk Recorder	3,210,551	-	-	-	3,210,551
028 - Emergency Communications	2,804,771	-	-	-	2,804,771
029 - Habitat Management Program	13,737,880	-	-	-	13,737,880
030 - Pension Liability	80,108,869	-	-	-	80,108,869
Total Special Revenue Funds	\$ 306,328,633	\$ -	\$ -	\$ -	\$ 306,328,633

Capital Project Funds:

401 - Facilities Project Fund	10,403	-	-	-	10,403
404 - Capital Projects	83,371,102	-	-	-	83,371,102
405 - NGEN Radio Project	1	-	-	-	1
Total Capital Projects Funds	\$ 83,381,506	\$ -	\$ -	\$ -	\$ 83,381,506

Total Governmental Funds	\$ 533,066,930	\$ -	\$ 109,036,663	\$ 29,326,875	\$ 394,703,392
---------------------------------	-----------------------	-------------	-----------------------	----------------------	-----------------------

Schedule 4

County of Monterey
Obligated Fund Balances - By Governmental Funds
Fiscal Year 2023-24

Fund Name and Fund Balance Descriptions	Obligated Fund Balances June 30, 2023	Decreases or Cancellations		Increases or New Obligated Fund Balances		Total Obligated Fund Balances for the Budget Year
		Recommended	Adopted by the Board of Supervisors	Recommended	Adopted by the Board of Supervisors	
1	2	3	4	5	6	7
General Fund						
Nonspendable:						
001 - 3026 - Reserve For Inventories	671,212	-	-	-	-	671,212
001 - 3028 - Prepaid Nonspendable	-	-	-	-	-	-
Restricted:						
001 - 3041 - Public Protection	4,389,072	1,112,544	-	-	-	3,276,528
001 - 3042 - General	6,234,731	-	-	-	-	6,234,731
001 - 3043 - Health and Sanitation	23,616,283	5,493,253	-	-	-	18,123,030
001 - 3045 - Recreation and Culture	153,733	-	-	-	-	153,733
001 - 3046 - Public Assistance	5,702,926	1,720,984	-	-	-	3,981,942
Committed:						
001 - 3111 - Strategic Reserve	76,595,486	-	-	-	-	76,595,486
Assigned:						
001 - 3012 - Assigned for Encumbrances	-	-	-	-	-	-
001 - 3065 - General Capital	1,399,301	250,000	-	-	-	1,149,301
001 - 3113 - General Fund Contingency	7,933,546	-	-	-	-	7,933,546
001 - 3115 - Compensated Absences	13,507,821	-	-	-	-	13,507,821
001 - 3120 - Health Clinics	1,520,000	-	-	-	-	1,520,000
001 - 3121 - Social Services	9,743	-	-	-	-	9,743
001 - 3123 - Capital Project	1,472,894	-	-	-	-	1,472,894
001 - 3124 - IT Charges Mitigation	2,061,209	1,488,000	-	-	-	573,209
001 - 3125 - Productivity Investment Program	0	-	-	-	-	0
001 - 3126 - Disaster Assistance Program	800,000	800,000	-	-	-	-
001 - 3128 - Revenue Stabilization	3,160,360	-	-	-	-	3,160,360
001 - 3132 - Cannabis Tax	550,000	550,000	-	-	-	-
001 - 3135 - Pension Trust Fund	-	-	-	-	-	-
Unassigned:						
001 - 3101 - Unassigned Fund Balance	4,993,253	-	-	-	-	4,993,253
Total General Fund	\$ 154,771,572	\$ 11,414,781	\$ -	\$ -	\$ -	\$ 143,356,791
Special Revenue Funds						
002 - Road Fund	21,073,970	-	-	-	-	21,073,970
003 - County Library Fund	5,965,485	-	-	-	-	5,965,485
005 - In-Home Support Services	91,569	-	-	-	-	91,569
006 - Fish and Game Propagation Fund	76,364	-	-	-	-	76,364
008 - Community Action Partnership	238,328	-	-	-	-	238,328
009 - Inclusionary Housing	461,691	-	-	-	-	461,691
011 - Economic Development Program	1,756,034	-	-	-	-	1,756,034
013 - Community Development Fund	2,462,616	-	-	-	-	2,462,616
016 - Emergency Medical Service Fund	1,914,367	-	-	-	-	1,914,367
021 - Workforce Development Board	-	-	-	-	-	-
022 - Local Revenue Fund 2011	58,906,816	-	-	-	-	58,906,816
023 - Behavioral Health	58,543,335	-	-	-	-	58,543,335
024 - Homeland Security	400,612	-	-	-	-	400,612
025 - H&W Realignment	54,087,895	-	-	-	-	54,087,895
026 - NGEN Operations & Maintenance	487,480	-	-	-	-	487,480
027 - County Clerk Recorder	3,210,551	-	-	-	-	3,210,551
028 - Emergency Communications	2,804,771	-	-	-	-	2,804,771
029 - Habitat Management Program	13,737,880	-	-	-	-	13,737,880
030 - Pension Liability	80,108,869	-	-	-	-	80,108,869
Total Special Revenue Funds	\$ 306,328,633	\$ -	\$ -	\$ -	\$ -	\$ 306,328,633
Capital Projects Funds						
401 - Facilities Project Fund	10,403	-	-	-	-	10,403
404 - Capital Projects	83,371,102	-	-	-	-	83,371,102
405 - NGEN Radio Project	1	-	-	-	-	1
Total Capital Projects Funds	\$ 83,381,506	\$ -	\$ -	\$ -	\$ -	\$ 83,381,506
Total Governmental Funds	\$ 544,481,711	\$ 11,414,781	\$ -	\$ -	\$ -	\$ 439,220,180

Schedule 5

County of Monterey Summary of Additional Financing Sources by Source and Fund Governmental Funds Fiscal Year 2023-24

Source Classification	Actual 2021-22	Adopted Budget 2022-23	Current Year Estimate 2022-23	Requested Budget 2023-24	Recommended Budget 2023-24	Recommended Change From Adopted
Summarization by Source						
Current Secured Property Tax	115,418,640	123,971,676	124,670,511	130,904,037	130,904,037	6,932,361
Current Unsecured Property Tax	5,733,797	4,989,017	5,682,243	5,805,410	5,805,410	816,393
Taxes Other than Current Property	158,570,143	139,479,456	154,599,841	158,596,155	158,596,155	19,116,699
Total Taxes:	\$279,722,579	\$268,440,149	\$284,952,595	\$295,305,602	\$295,305,602	\$26,865,453
Licenses, Permits, and Franchises	24,931,679	23,097,050	24,375,974	27,893,468	27,893,468	4,796,418
Fines, Forfeitures, and Penalties	12,406,071	12,259,936	8,552,880	11,430,072	11,430,072	(829,864)
Revenue from Use of Money & Property	2,022,576	3,987,354	5,297,539	3,916,210	3,916,210	(71,144)
Intergovernmental Revenues	610,642,967	667,920,524	624,294,887	641,877,328	655,486,510	(12,434,014)
Charges for Services	79,295,067	87,909,760	80,589,400	102,188,705	102,188,705	14,278,945
Miscellaneous Revenues	9,794,195	13,624,833	20,000,691	8,574,642	8,478,642	(5,146,191)
Other Financing Sources	183,961,212	217,034,145	231,081,673	204,433,185	206,871,185	(10,162,960)
Grand Total	\$1,202,776,347	\$1,294,273,751	\$1,279,145,639	\$1,295,619,212	\$1,311,570,394	\$ 17,296,643

Schedule 6

County of Monterey Detail of Additional Financing Sources by Fund and Account Governmental Funds Fiscal Year 2023-24

Source Classification	Actual 2021-22	Adopted Budget 2022-23	Current Year Estimate 2022-23	Requested Budget 2023-24	Recommended Budget 2023-24	Recommended Change From Adopted
001 - General						
Taxes						
4010 - Property Tax - Current Secured	106,925,532	114,780,740	115,479,575	121,253,554	121,253,554	6,472,814
4015 - Property Tax - Current Unsecured	5,364,815	4,671,589	5,364,815	5,472,111	5,472,111	800,522
4020 - Property Tax In-Lieu of VLF	62,893,210	66,620,570	66,620,570	69,951,598	69,951,598	3,331,028
4025 - Property Tax - Prior Secured	1,278,837	1,064,536	1,108,613	1,108,613	1,108,613	44,077
4030 - Property Tax - Prior Unsecured	45,002	35,691	35,691	35,691	35,691	-
4035 - Property Tax - Current Supplemental	2,975,054	2,189,640	2,458,346	2,458,346	2,458,346	268,706
4040 - Property Tax - Prior Supplemental	163,953	142,293	142,293	142,293	142,293	-
4050 - Sales and Use Taxes	15,605,949	12,276,400	13,937,651	15,270,555	15,270,555	2,994,155
4090 - Other Property Taxes	12,599,264	9,453,197	11,768,568	11,768,568	11,768,568	2,315,371
4100 - Transient Occupancy Tax	40,025,756	27,823,878	40,025,756	40,025,756	40,025,756	12,201,878
4110 - Real Property Transfer Tax	5,410,176	4,034,275	4,034,275	3,074,133	3,074,133	(960,142)
4120 - Other Taxes	70	-	-	-	-	-
4130 - Cannabis Tax	9,115,604	7,396,341	4,587,611	4,587,611	4,587,611	(2,808,730)
Total Taxes	\$ 262,403,221	\$ 250,489,150	\$ 265,563,764	\$ 275,148,829	\$ 275,148,829	\$ 24,659,679
Licenses, Permits, and Franchises						
4200 - Animal Licenses	145,983	152,000	138,403	296,000	296,000	144,000
4220 - Business Licenses	3,980,157	5,587,439	5,148,631	5,870,359	5,870,359	282,920
4230 - Construction Permits	7,936,049	7,563,280	8,329,353	9,142,146	9,142,146	1,578,866
4250 - Road Privileges and Permits	-	-	1,050	-	-	-
4260 - Zoning Permits	2,487,741	2,094,132	2,171,403	2,344,590	2,344,590	250,458
4270 - Franchises	8,811,289	6,630,711	7,215,365	7,215,366	7,215,366	584,655
4275 - PEG Fees Received	472,725	-	-	-	-	-
4300 - Other Licenses and Permits	863,616	896,356	857,807	975,007	975,007	78,651
Total Licenses, Permits, and Franchises	\$ 24,697,560	\$ 22,923,918	\$ 23,862,012	\$ 25,843,468	\$ 25,843,468	\$ 2,919,550
Fines, Forfeitures, and Penalties						
4400 - Vehicle Code Fines	706,037	902,633	643,167	761,593	761,593	(141,040)
4450 - Other Court Fines	671,302	693,224	604,468	745,252	745,252	52,028
4500 - Forfeitures and Penalties	6,082,435	7,138,577	3,833,320	6,549,221	6,549,221	(589,356)
4550 - Penalties and Costs on Delinquent Taxes	4,127,591	2,499,198	2,505,818	2,500,258	2,500,258	1,060
Total Fines, Forfeitures, and Penalties	\$ 11,587,365	\$ 11,233,632	\$ 7,586,773	\$ 10,556,324	\$ 10,556,324	\$ (677,308)
Revenue from Use of Money & Property						
4600 - Investment Income	1,971,526	2,337,383	2,341,382	2,343,185	2,343,185	5,802
4675 - Rents and Concessions	548,864	793,263	554,572	551,620	551,620	(241,643)
Total Revenue from Use of Money & Property	\$ 2,520,390	\$ 3,130,646	\$ 2,895,954	\$ 2,894,805	\$ 2,894,805	\$ (235,841)
Intergovernmental Revenues						
4820 - Vehicle License Fee	423,070	177,745	270,725	270,725	270,725	92,980
4900 - State Aid - Public Assistance Administration	44,862,351	44,040,999	43,227,525	53,130,006	53,130,006	9,089,007
4910 - State Aid - Public Assistance Programs	(785,135)	8,241,114	5,601,515	6,670,469	6,670,469	(1,570,645)
4975 - State Aid - Health Programs	6,505,737	4,303,885	3,836,498	11,296,021	11,296,021	6,992,136
4985 - Tobacco Program (Prop 99)	453,332	307,165	291,807	230,374	230,374	(76,791)
5000 - State Aid - Agriculture	7,398,162	6,927,575	6,916,645	7,226,463	7,226,463	298,888
5020 - State Disaster Relief	90,513	-	-	-	-	-
5025 - State Veterans' Affairs	209,160	195,577	285,438	289,713	289,713	94,136
5030 - Homeowners Property Tax Relief	432,885	435,663	432,885	432,885	432,885	(2,778)
5035 - Public Safety - Sales Tax	39,836,411	38,641,759	39,780,127	41,018,162	41,018,162	2,376,403
5050 - Other State Aid	19,389,569	18,511,863	18,374,135	24,967,862	24,967,862	6,455,999
5075 - SB 90 Reimbursements	192,712	-	-	-	-	-
5095 - Peace Officer Training (Post)	29,993	140,250	243,378	227,180	227,180	86,930
5100 - Federal - In-Lieu Taxes	1,009,996	975,096	1,009,996	1,009,996	1,009,996	34,900
5200 - Federal Aid - Public Assistance Administration	51,368,000	76,462,206	72,429,115	72,714,979	72,714,979	(3,747,227)
5225 - Federal Aid - Public Assistance Programs	20,741,782	25,623,986	28,848,606	35,307,697	35,307,697	9,683,711
5240 - Federal Aid - Health Administration	5,217,354	3,342,887	2,180,154	1,788,543	1,788,543	(1,554,344)
5260 - Federal Aid - Disaster Relief	456,994	65,186	65,186	-	-	(65,186)
5290 - Federal Aid Other	78,263,083	64,953,829	50,708,151	35,846,948	49,456,130	(15,497,699)
5350 - Aid - Other Governmental Agencies	1,457,666	1,167,570	1,067,570	1,537,600	1,537,600	370,030
5355 - Aid from City/County	75,291	164,000	214,000	309,951	309,951	145,951
5360 - Aid from Special District/JPA	13,532	-	11,006	-	-	-
Total Intergovernmental Revenues	\$ 277,642,457	\$ 294,678,355	\$ 275,794,462	\$ 294,275,574	\$ 307,884,756	\$ 13,206,401
Charges for Services						
5400 - Assessment and Tax Collection Fees	4,162,923	3,995,453	4,110,620	4,102,197	4,102,197	106,744
5430 - Auditing and Accounting Fees	1,583,935	1,669,868	1,420,224	2,136,071	2,136,071	466,203
5445 - Communication Services	-	100,000	100,000	100,000	100,000	-
5460 - Election Services	3,203,257	1,000,000	1,000,000	350,000	350,000	(650,000)

Source Classification	Actual	Adopted Budget	Current Year Estimate	Requested Budget	Recommended Budget	Recommended Change From
	2021-22	2022-23	2022-23	2023-24	2023-24	Adopted
5475 - Legal Services	600,802	461,400	458,896	470,100	470,100	8,700
5505 - Planning and Engineering Services	1,548,406	1,198,575	1,277,800	1,391,206	1,391,206	192,631
5520 - Agricultural Services	869,180	900,000	900,000	900,000	900,000	-
5535 - Civil Process Services	3,379,536	4,765,242	3,822,247	4,980,361	4,980,361	215,119
5550 - Estate Fees	77,610	53,900	40,000	61,600	61,600	7,700
5560 - Humane Services	20,105	7,000	13,000	14,000	14,000	7,000
5570 - Law Enforcement Services	3,461,643	4,441,112	3,975,978	4,345,097	4,345,097	(96,015)
5580 - Recording Fees	2,963,036	3,434,056	2,041,659	2,515,248	2,515,248	(918,808)
5600 - Health Fees	40,969,983	50,285,154	45,185,927	50,005,041	50,005,041	(280,113)
5640 - Mental Health Fees	454	4,626	4,269	4,329	4,329	(297)
5660 - Children's Services	440	400	375	425	425	25
5685 - Adoption Fees	128,461	65,000	97,084	95,000	95,000	30,000
5690 - Institutional Care and Services	2,655	311,998	311,998	311,998	311,998	-
5730 - Park and Recreation Services	689,771	483,524	627,822	655,283	655,283	171,759
5750 - Other Services	4,115,285	4,031,270	3,596,104	3,580,195	3,580,195	(451,075)
Total Charges for Services	\$ 67,777,481	\$ 77,208,578	\$ 68,984,003	\$ 76,018,151	\$ 76,018,151	\$ (1,190,427)
Miscellaneous Revenues						
5800 - Other Taxable Sales	32,562	40,000	40,000	40,000	40,000	-
5855 - Other Reimbursement	884,554	4,999,860	12,216,307	2,158,442	2,062,442	(2,937,418)
5860 - Tobacco Settlement	4,720,882	4,316,018	4,470,336	4,470,336	4,470,336	154,318
5870 - Miscellaneous Revenues	670,681	1,187,304	336,617	1,041,004	1,041,004	(146,300)
5875 - Cash Overages/Shortages	39	-	702	408	408	408
5980 - Contributions	262,842	229,400	269,497	250,548	250,548	21,148
Total Miscellaneous Revenues	\$ 6,571,560	\$ 10,772,582	\$ 17,333,459	\$ 7,960,738	\$ 7,864,738	\$ (2,907,844)
Other Financing Sources						
5900 - Sale of Capital Assets	60,422	40,000	37,550	48,110	48,110	8,110
5940 - Operating Transfers In	108,152,083	122,877,751	124,325,682	128,741,761	129,691,761	6,814,010
5950 - Debt Issuance	500	-	-	-	-	-
5958 - Lease Right-To-Use Financing Sources	279,341	-	254,692	262,180	262,180	262,180
Total Other Financing Sources	\$ 108,492,346	\$ 122,917,751	\$ 124,617,924	\$ 129,052,051	\$ 130,002,051	\$ 7,084,300
Total 001 - General	\$ 761,692,381	\$ 793,354,612	\$ 786,638,351	\$ 821,749,940	\$ 836,213,122	\$ 42,858,510
002 - Road Fund						
Taxes						
4050 - Sales and Use Taxes	7,119,821	7,652,168	9,090,000	9,343,000	9,343,000	1,690,832
Total Taxes	\$ 7,119,821	\$ 7,652,168	\$ 9,090,000	\$ 9,343,000	\$ 9,343,000	\$ 1,690,832
Licenses, Permits, and Franchises						
4230 - Construction Permits	1,400	448	-	-	-	(448)
4250 - Road Privileges and Permits	232,719	172,684	513,962	2,050,000	2,050,000	1,877,316
Total Licenses, Permits, and Franchises	\$ 234,119	\$ 173,132	\$ 513,962	\$ 2,050,000	\$ 2,050,000	\$ 1,876,868
Revenue from Use of Money & Property						
4600 - Investment Income	73,585	77,762	220,755	244,642	244,642	166,880
Total Revenue from Use of Money & Property	\$ 73,585	\$ 77,762	\$ 220,755	\$ 244,642	\$ 244,642	\$ 166,880
Intergovernmental Revenues						
4800 - State Highway Users Tax	19,705,610	23,014,628	22,040,955	24,125,028	24,125,028	1,110,400
5010 - State Aid - Construction Capital Grants	523,942	488,729	1,189,205	5,068,032	5,068,032	4,579,303
5011 - State Aid - Construction Operating Grants	725,486	725,486	725,486	725,486	725,486	-
5020 - State Disaster Relief	327,698	-	658,175	-	-	-
5250 - Federal Aid - Construction Capital Grants	5,464,680	30,055,138	19,836,441	6,656,984	6,656,984	(23,398,154)
5260 - Federal Aid - Disaster Relief	660,797	8,119,850	2,568,385	5,204,590	5,204,590	(2,915,260)
5270 - Federal Aid - Forest Reserve Revenue	7,678	6,220	6,220	6,220	6,220	-
5290 - Federal Aid Other	110,000	-	-	-	-	-
5350 - Aid - Other Governmental Agencies	-	350,000	355,000	135,000	135,000	(215,000)
Total Intergovernmental Revenues	\$ 27,525,892	\$ 62,760,051	\$ 47,379,867	\$ 41,921,340	\$ 41,921,340	\$ (20,838,711)
Charges for Services						
5750 - Other Services	1,362,770	604,181	820,228	801,612	801,612	197,431
Total Charges for Services	\$ 1,362,770	\$ 604,181	\$ 820,228	\$ 801,612	\$ 801,612	\$ 197,431
Miscellaneous Revenues						
5855 - Other Reimbursement	788,555	483,736	1,940,514	50,120	50,120	(433,616)
5870 - Miscellaneous Revenues	19,145	1,858,847	8,590	9,101	9,101	(1,849,746)
Total Miscellaneous Revenues	\$ 807,700	\$ 2,342,583	\$ 1,949,104	\$ 59,221	\$ 59,221	\$ (2,283,362)
Other Financing Sources						
5900 - Sale of Capital Assets	28,342	13,195	8,500	18,687	18,687	5,492
5940 - Operating Transfers In	5,626,467	5,984,574	6,054,069	7,134,289	7,134,289	1,149,715
Total Other Financing Sources	\$ 5,654,809	\$ 5,997,769	\$ 6,062,569	\$ 7,152,976	\$ 7,152,976	\$ 1,155,207
Total 002 - Road Fund	\$ 42,778,696	\$ 79,607,646	\$ 66,036,485	\$ 61,572,791	\$ 61,572,791	\$ (18,034,855)

Schedules

Source Classification	Actual 2021-22	Adopted Budget 2022-23	Current Year Estimate 2022-23	Requested Budget 2023-24	Recommended Budget 2023-24	Recommended Change From Adopted
003 - Library Fund						
Taxes						
4010 - Property Tax - Current Secured	8,493,108	9,190,936	9,190,936	9,650,483	9,650,483	459,547
4015 - Property Tax - Current Unsecured	368,982	317,428	317,428	333,299	333,299	15,871
4025 - Property Tax - Prior Secured	101,781	75,708	75,708	79,493	79,493	3,785
4030 - Property Tax - Prior Unsecured	3,589	1,750	1,750	1,838	1,838	88
4035 - Property Tax - Current Supplemental	233,462	132,390	132,390	139,010	139,010	6,620
4040 - Property Tax - Prior Supplemental	12,952	10,365	10,365	10,883	10,883	518
4090 - Other Property Taxes	985,664	570,254	570,254	598,767	598,767	28,513
Total Taxes	\$ 10,199,537	\$ 10,298,831	\$ 10,298,831	\$ 10,813,773	\$ 10,813,773	\$ 514,942
Revenue from Use of Money & Property						
4600 - Investment Income	26,215	7,908	7,908	8,066	8,066	158
Total Revenue from Use of Money & Property	\$ 26,215	\$ 7,908	\$ 7,908	\$ 8,066	\$ 8,066	\$ 158
Intergovernmental Revenues						
5020 - State Disaster Relief	8,352	-	-	-	-	-
5030 - Homeowners Property Tax Relief	34,192	37,308	37,308	38,054	38,054	746
5050 - Other State Aid	272,377	190,539	190,539	209,592	209,592	19,053
Total Intergovernmental Revenues	\$ 314,921	\$ 227,847	\$ 227,847	\$ 247,646	\$ 247,646	\$ 19,799
Charges for Services						
5725 - Library Services	32,502	120,000	50,000	50,000	50,000	(70,000)
Total Charges for Services	\$ 32,502	\$ 120,000	\$ 50,000	\$ 50,000	\$ 50,000	\$ (70,000)
Miscellaneous Revenues						
5855 - Other Reimbursement	5	-	-	-	-	-
5870 - Miscellaneous Revenues	4,533	-	-	-	-	-
5980 - Contributions	398,611	240,783	240,783	240,783	240,783	-
Total Miscellaneous Revenues	\$ 403,149	\$ 240,783	\$ 240,783	\$ 240,783	\$ 240,783	\$ -
Other Financing Sources						
5900 - Sale of Capital Assets	16,920	-	-	-	-	-
5940 - Operating Transfers In	382,648	2,108,171	2,108,171	283,889	283,889	(1,824,282)
Total Other Financing Sources	\$ 399,568	\$ 2,108,171	\$ 2,108,171	\$ 283,889	\$ 283,889	\$ (1,824,282)
Total 003 - Library Fund	\$ 11,375,893	\$ 13,003,540	\$ 12,933,540	\$ 11,644,157	\$ 11,644,157	\$ (1,359,383)
005 - In-Home Support Services						
Revenue from Use of Money & Property						
4600 - Investment Income	(404)	-	117	-	-	-
Total Revenue from Use of Money & Property	\$ (404)	\$ -	\$ 117	\$ -	\$ -	\$ -
Intergovernmental Revenues						
4910 - State Aid - Public Assistance Programs	351,830	347,513	338,482	352,970	352,970	5,457
5290 - Federal Aid Other	383,131	501,146	450,075	495,113	495,113	(6,033)
Total Intergovernmental Revenues	\$ 734,961	\$ 848,659	\$ 788,557	\$ 848,083	\$ 848,083	\$ (576)
Other Financing Sources						
5940 - Operating Transfers In	69,679	170,075	170,075	171,770	171,770	1,695
Total Other Financing Sources	\$ 69,679	\$ 170,075	\$ 170,075	\$ 171,770	\$ 171,770	\$ 1,695
Total 005 - In-Home Support Services	\$ 804,236	\$ 1,018,734	\$ 958,749	\$ 1,019,853	\$ 1,019,853	\$ 1,119
006 - Fish & Game Propagation Fund						
Fines, Forfeitures, and Penalties						
4450 - Other Court Fines	38,660	38,214	41,107	33,748	33,748	(4,466)
Total Fines, Forfeitures, and Penalties	\$ 38,660	\$ 38,214	\$ 41,107	\$ 33,748	\$ 33,748	\$ (4,466)
Revenue from Use of Money & Property						
4600 - Investment Income	338	307	307	781	781	474
Total Revenue from Use of Money & Property	\$ 338	\$ 307	\$ 307	\$ 781	\$ 781	\$ 474
Other Financing Sources						
5940 - Operating Transfers In	10,500	10,500	10,500	10,500	10,500	-
Total Other Financing Sources	\$ 10,500	\$ 10,500	\$ 10,500	\$ 10,500	\$ 10,500	\$ -
Total 006 - Fish & Game Propagation Fund	\$ 49,498	\$ 49,021	\$ 51,914	\$ 45,029	\$ 45,029	\$ (3,992)
008 - Community Action Partnership						
Revenue from Use of Money & Property						
4600 - Investment Income	367	434	1,000	500	500	66

Source Classification	Actual 2021-22	Adopted Budget 2022-23	Current Year Estimate 2022-23	Requested Budget 2023-24	Recommended Budget 2023-24	Recommended Change From Adopted
Total Revenue from Use of Money & Property	\$ 367	\$ 434	\$ 1,000	\$ 500	\$ 500	\$ 66
Intergovernmental Revenues						
5290 - Federal Aid Other	884,932	518,692	534,102	502,515	502,515	(16,177)
Total Intergovernmental Revenues	\$ 884,932	\$ 518,692	\$ 534,102	\$ 502,515	\$ 502,515	\$ (16,177)
Other Financing Sources						
5940 - Operating Transfers In	954	755	755	718	718	(37)
Total Other Financing Sources	\$ 954	\$ 755	\$ 755	\$ 718	\$ 718	\$ (37)
Total 008 - Community Action Partnership	\$ 886,253	\$ 519,881	\$ 535,857	\$ 503,733	\$ 503,733	\$ (16,148)
009 - Inclusionary Housing						
Revenue from Use of Money & Property						
4600 - Investment Income	2,727	6,500	2,700	2,000	2,000	(4,500)
4650 - Interest on Notes Receivable	36,064	7,030	4,000	4,000	4,000	(3,030)
Total Revenue from Use of Money & Property	\$ 38,791	\$ 13,530	\$ 6,700	\$ 6,000	\$ 6,000	\$ (7,530)
Intergovernmental Revenues						
5325 - Other In-Lieu Taxes	13,500	-	-	-	-	-
Total Intergovernmental Revenues	\$ 13,500	\$ -	\$ -	\$ -	\$ -	\$ -
Charges for Services						
5750 - Other Services	5,630	5,000	1,300	1,500	1,500	(3,500)
Total Charges for Services	\$ 5,630	\$ 5,000	\$ 1,300	\$ 1,500	\$ 1,500	\$ (3,500)
Miscellaneous Revenues						
5960 - Loan Repayment	(328)	21,375	15,000	15,000	15,000	(6,375)
Total Miscellaneous Revenues	\$ (328)	\$ 21,375	\$ 15,000	\$ 15,000	\$ 15,000	\$ (6,375)
Other Financing Sources						
5940 - Operating Transfers In	-	62,964	-	-	-	(62,964)
Total Other Financing Sources	\$ -	\$ 62,964	\$ -	\$ -	\$ -	\$ (62,964)
Total 009 - Inclusionary Housing	\$ 57,593	\$ 102,869	\$ 23,000	\$ 22,500	\$ 22,500	\$ (80,369)
011 - Revolving Loan Fund						
Revenue from Use of Money & Property						
4600 - Investment Income	2,104	400	400	400	400	-
4650 - Interest on Notes Receivable	73,190	100,000	100,000	100,000	100,000	-
Total Revenue from Use of Money & Property	\$ 75,294	\$ 100,400	\$ 100,400	\$ 100,400	\$ 100,400	\$ -
Intergovernmental Revenues						
5290 - Federal Aid Other	1,635,614	-	-	-	-	-
Total Intergovernmental Revenues	\$ 1,635,614	\$ -	\$ -	\$ -	\$ -	\$ -
Charges for Services						
5750 - Other Services	-	50,000	50,000	50,000	50,000	-
Total Charges for Services	\$ -	\$ 50,000	\$ 50,000	\$ 50,000	\$ 50,000	\$ -
Miscellaneous Revenues						
5870 - Miscellaneous Revenues	(61,136)	-	2,223	-	-	-
Total Miscellaneous Revenues	\$ (61,136)	\$ -	\$ 2,223	\$ -	\$ -	\$ -
Total 011 - Revolving Loan Fund	\$ 1,649,771	\$ 150,400	\$ 152,623	\$ 150,400	\$ 150,400	\$ -
013 - Community Development Fund						
Revenue from Use of Money & Property						
4600 - Investment Income	13,152	19,455	4,000	4,000	4,000	(15,455)
4650 - Interest on Notes Receivable	171,686	25,501	110,200	10,000	10,000	(15,501)
Total Revenue from Use of Money & Property	\$ 184,838	\$ 44,956	\$ 114,200	\$ 14,000	\$ 14,000	\$ (30,956)
Intergovernmental Revenues						
5050 - Other State Aid	38,281	2,745,541	1,407,199	2,918,300	2,918,300	172,759
5290 - Federal Aid Other	1,885,239	3,817,129	3,020,624	1,226,268	1,226,268	(2,590,861)
5350 - Aid - Other Governmental Agencies	-	750,464	-	-	-	(750,464)
Total Intergovernmental Revenues	\$ 1,923,520	\$ 7,313,134	\$ 4,427,823	\$ 4,144,568	\$ 4,144,568	\$ (3,168,566)
Charges for Services						
5750 - Other Services	-	71,145	-	4,573	4,573	(66,572)
Total Charges for Services	\$ -	\$ 71,145	\$ -	\$ 4,573	\$ 4,573	\$ (66,572)
Miscellaneous Revenues						
5870 - Miscellaneous Revenues	356,609	-	-	-	-	-
5960 - Loan Repayment	32,917	30,510	61,000	15,000	15,000	(15,510)

Source Classification	Actual 2021-22	Adopted Budget 2022-23	Current Year Estimate 2022-23	Requested Budget 2023-24	Recommended Budget 2023-24	Recommended Change From Adopted
Total Miscellaneous Revenues	\$ 389,526	\$ 30,510	\$ 61,000	\$ 15,000	\$ 15,000	\$ (15,510)
Total 013 - Community Development Fund	\$ 2,497,883	\$ 7,459,745	\$ 4,603,023	\$ 4,178,141	\$ 4,178,141	\$ (3,281,604)
016 - Emergency Medical Service Fund						
Fines, Forfeitures, and Penalties						
4450 - Other Court Fines	656,934	910,000	825,000	725,000	725,000	(185,000)
Total Fines, Forfeitures, and Penalties	\$ 656,934	\$ 910,000	\$ 825,000	\$ 725,000	\$ 725,000	\$ (185,000)
Revenue from Use of Money & Property						
4600 - Investment Income	10,079	15,000	10,000	15,000	15,000	-
Total Revenue from Use of Money & Property	\$ 10,079	\$ 15,000	\$ 10,000	\$ 15,000	\$ 15,000	\$ -
Miscellaneous Revenues						
5855 - Other Reimbursement	8,853	10,000	8,900	8,900	8,900	(1,100)
Total Miscellaneous Revenues	\$ 8,853	\$ 10,000	\$ 8,900	\$ 8,900	\$ 8,900	\$ (1,100)
Total 016 - Emergency Medical Service Fund	\$ 675,866	\$ 935,000	\$ 843,900	\$ 748,900	\$ 748,900	\$ (186,100)
021 - Workforce Development Board						
Revenue from Use of Money & Property						
4600 - Investment Income	(409)	-	-	-	-	-
Total Revenue from Use of Money & Property	\$ (409)	\$ -	\$ -	\$ -	\$ -	\$ -
Intergovernmental Revenues						
5050 - Other State Aid	1,677,572	1,293,000	1,293,000	3,065,845	3,065,845	1,772,845
5290 - Federal Aid Other	6,473,377	6,677,380	6,677,380	6,628,190	6,628,190	(49,190)
5350 - Aid - Other Governmental Agencies	62,225	-	-	-	-	-
Total Intergovernmental Revenues	\$ 8,213,174	\$ 7,970,380	\$ 7,970,380	\$ 9,694,035	\$ 9,694,035	\$ 1,723,655
Miscellaneous Revenues						
5870 - Miscellaneous Revenues	96,100	-	-	-	-	-
Total Miscellaneous Revenues	\$ 96,100	\$ -	\$ -	\$ -	\$ -	\$ -
Other Financing Sources						
5940 - Operating Transfers In	596,728	711,544	711,544	736,544	736,544	25,000
Total Miscellaneous Revenues	\$ 596,728	\$ 711,544	\$ 711,544	\$ 736,544	\$ 736,544	\$ 25,000
Total 021 - Workforce Development Board	\$ 8,905,593	\$ 8,681,924	\$ 8,681,924	\$ 10,430,579	\$ 10,430,579	\$ 1,748,655
022 - Local Revenue Fund						
Intergovernmental Revenues						
4920 - Realignment - Social Services	23,917,861	24,596,357	27,136,762	24,638,807	24,638,807	42,450
4960 - Realignment - Mental Health	28,520,504	21,764,942	27,132,949	29,305,772	29,305,772	7,540,830
5035 - Public Safety - Sales Tax	35,772,982	31,893,870	34,764,272	33,560,971	33,560,971	1,667,101
5050 - Other State Aid	-	5,415,000	5,474,483	6,030,820	6,030,820	615,820
Total Intergovernmental Revenues	\$ 88,211,346	\$ 83,670,169	\$ 94,508,466	\$ 93,536,370	\$ 93,536,370	\$ 9,866,201
Total 022 - Local Revenue Fund	\$ 88,211,346	\$ 83,670,169	\$ 94,508,466	\$ 93,536,370	\$ 93,536,370	\$ 9,866,201
023 - Behavioral Health						
Fines, Forfeitures, and Penalties						
4400 - Vehicle Code Fines	123,112	78,090	100,000	115,000	115,000	36,910
Total Fines, Forfeitures, and Penalties	\$ 123,112	\$ 78,090	\$ 100,000	\$ 115,000	\$ 115,000	\$ 36,910
Revenue from Use of Money & Property						
4600 - Investment Income	189,172	195,000	200,000	195,000	195,000	-
4675 - Rents and Concessions	43,879	43,900	43,900	43,993	43,993	93
Total Revenue from Use of Money & Property	\$ 233,051	\$ 238,900	\$ 243,900	\$ 238,993	\$ 238,993	\$ 93
Intergovernmental Revenues						
4820 - Vehicle License Fee	2,817,038	162,007	162,007	162,007	162,007	-
4950 - State Aid - Mental Health	35,139,807	39,363,786	33,337,921	39,959,516	39,959,516	595,730
4975 - State Aid - Health Programs	8,753,799	10,111,211	8,486,799	8,527,950	8,527,950	(1,583,261)
5050 - Other State Aid	18,882	-	-	-	-	-
5240 - Federal Aid - Health Administration	5,194,918	5,591,582	5,091,582	6,726,633	6,726,633	1,135,051
5290 - Federal Aid Other	65,618,093	51,976,482	49,181,435	53,283,205	53,283,205	1,306,723
5350 - Aid - Other Governmental Agencies	8,100,321	7,481,693	7,481,693	6,814,549	6,814,549	(667,144)
Total Intergovernmental Revenues	\$ 125,642,859	\$ 114,686,761	\$ 103,741,437	\$ 115,473,860	\$ 115,473,860	\$ 787,099
Charges for Services						
5600 - Health Fees	98,368	108,649	108,649	115,000	115,000	6,351

Source Classification	Actual 2021-22	Adopted Budget 2022-23	Current Year Estimate 2022-23	Requested Budget 2023-24	Recommended Budget 2023-24	Recommended Change From Adopted
5640 - Mental Health Fees	1,073,646	1,349,592	1,867,286	1,349,592	1,349,592	-
5750 - Other Services	25,211	11,000	17,500	18,500	18,500	7,500
Total Charges for Services	\$ 1,197,225	\$ 1,469,241	\$ 1,993,435	\$ 1,483,092	\$ 1,483,092	\$ 13,851
Miscellaneous Revenues						
5855 - Other Reimbursement	1,113,284	200,000	275,000	250,000	250,000	50,000
5870 - Miscellaneous Revenues	18,765	-	1,716	-	-	-
Total Miscellaneous Revenues	\$ 1,132,049	\$ 200,000	\$ 276,716	\$ 250,000	\$ 250,000	\$ 50,000
Other Financing Sources						
5900 - Sale of Capital Assets	12,700	-	-	-	-	-
5940 - Operating Transfers In	29,953,658	33,606,114	33,606,114	41,961,516	41,961,516	8,355,402
Total Other Financing Sources	\$ 29,966,358	\$ 33,606,114	\$ 33,606,114	\$ 41,961,516	\$ 41,961,516	\$ 8,355,402
Total 023 - Behavioral Health	\$ 158,294,653	\$ 150,279,106	\$ 139,961,602	\$ 159,522,461	\$ 159,522,461	\$ 9,243,355
024 - Homeland Security Grant						
Revenue from Use of Money & Property						
4600 - Investment Income	3,259	3,818	3,818	6,444	6,444	2,626
Total Revenue from Use of Money & Property	\$ 3,259	\$ 3,818	\$ 3,818	\$ 6,444	\$ 6,444	\$ 2,626
Intergovernmental Revenues						
5050 - Other State Aid	4,932	-	15,000	-	-	-
5290 - Federal Aid Other	15,104	1,642,141	1,542,141	1,144,787	1,144,787	(497,354)
Total Intergovernmental Revenues	\$ 20,036	\$ 1,642,141	\$ 1,557,141	\$ 1,144,787	\$ 1,144,787	\$ (497,354)
Total 024 - Homeland Security Grant	\$ 23,296	\$ 1,645,959	\$ 1,560,959	\$ 1,151,231	\$ 1,151,231	\$ (494,728)
025 - H&W Realignment						
Intergovernmental Revenues						
4820 - Vehicle License Fee	10,187,399	7,026,195	6,828,364	6,857,322	6,857,322	(168,873)
4920 - Realignment - Social Services	48,793,992	42,095,903	45,897,642	42,075,537	42,075,537	(20,366)
4960 - Realignment - Mental Health	11,464,783	10,301,721	10,301,721	10,301,721	10,301,721	-
4990 - Realignment - Health	764,109	1,087,382	636,894	887,353	887,353	(200,029)
Total Intergovernmental Revenues	\$ 71,210,283	\$ 60,511,201	\$ 63,664,621	\$ 60,121,933	\$ 60,121,933	\$ (389,268)
Other Financing Sources						
5940 - Operating Transfers In	5,239,014	5,336,288	5,239,014	5,239,014	5,239,014	(97,274)
Total Other Financing Sources	\$ 5,239,014	\$ 5,336,288	\$ 5,239,014	\$ 5,239,014	\$ 5,239,014	\$ (97,274)
Total 025 - H&W Realignment	\$ 76,449,297	\$ 65,847,489	\$ 68,903,635	\$ 65,360,947	\$ 65,360,947	\$ (486,542)
026 - NGEN Operations & Maintenance						
Revenue from Use of Money & Property						
4600 - Investment Income	5,365	-	-	-	-	-
4675 - Rents and Concessions	28,526	28,800	28,800	29,664	29,664	864
Total Revenue from Use of Money & Property	\$ 33,891	\$ 28,800	\$ 28,800	\$ 29,664	\$ 29,664	\$ 864
Charges for Services						
5750 - Other Services	1,060,650	1,039,049	1,039,049	851,398	851,398	(187,651)
Total Other Financing Sources	\$ 1,060,650	\$ 1,039,049	\$ 1,039,049	\$ 851,398	\$ 851,398	\$ (187,651)
Total 026 - NGEN Operations & Maintenance	\$ 1,094,542	\$ 1,067,849	\$ 1,067,849	\$ 881,062	\$ 881,062	\$ (186,787)
027 - County Clerk/Recorder						
Revenue from Use of Money & Property						
4600 - Investment Income	5,453	-	-	-	-	-
Total Revenue from Use of Money & Property	\$ 5,453	\$ -	\$ -	\$ -	\$ -	\$ -
Charges for Services						
5580 - Recording Fees	632,041	400,000	708,819	426,000	426,000	26,000
Total Charges for Services	\$ 632,041	\$ 400,000	\$ 708,819	\$ 426,000	\$ 426,000	\$ 26,000
Other Financing Sources						
5940 - Operating Transfers In	2,362,402	-	-	-	-	-
Total Charges for Services	\$ 2,362,402	\$ -	\$ -	\$ -	\$ -	\$ -
Total 027 - County Clerk/Recorder	\$ 2,999,895	\$ 400,000	\$ 708,819	\$ 426,000	\$ 426,000	\$ 26,000
028 - Emergency Communications						

Source Classification	Actual 2021-22	Adopted Budget 2022-23	Current Year Estimate 2022-23	Requested Budget 2023-24	Recommended Budget 2023-24	Recommended Change From Adopted
Revenue from Use of Money & Property						
4600 - Investment Income	16,530	7,200	7,200	35,000	35,000	27,800
4675 - Rents and Concessions	137,928	140,687	140,687	144,909	144,909	4,222
Total Revenue from Use of Money & Property	\$ 154,458	\$ 147,887	\$ 147,887	\$ 179,909	\$ 179,909	\$ 32,022
Intergovernmental Revenues						
5035 - Public Safety - Sales Tax	4,426,268	4,341,787	4,482,552	4,572,397	4,572,397	230,610
5050 - Other State Aid	-	9,000	9,000	25,000	25,000	16,000
5095 - Peace Officer Training (Post)	19,761	15,000	15,000	15,000	15,000	-
5290 - Federal Aid Other	278,046	-	-	-	-	-
Total Intergovernmental Revenues	\$ 4,724,075	\$ 4,365,787	\$ 4,506,552	\$ 4,612,397	\$ 4,612,397	\$ 246,610
Charges for Services						
5445 - Communication Services	6,777,658	6,764,594	6,764,594	7,087,805	7,087,805	323,211
5750 - Other Services	199,725	177,972	177,972	186,871	186,871	8,899
Total Charges for Services	\$ 6,977,383	\$ 6,942,566	\$ 6,942,566	\$ 7,274,676	\$ 7,274,676	\$ 332,110
Miscellaneous Revenues						
5855 - Other Reimbursement	12,036	7,000	7,000	25,000	25,000	18,000
Total Miscellaneous Revenues	\$ 12,036	\$ 7,000	\$ 7,000	\$ 25,000	\$ 25,000	\$ 18,000
Other Financing Sources						
5940 - Operating Transfers In	1,602,097	1,775,113	1,011,698	2,096,951	2,096,951	321,838
Total Other Financing Sources	\$ 1,602,097	\$ 1,775,113	\$ 1,011,698	\$ 2,096,951	\$ 2,096,951	\$ 321,838
Total 028 - Emergency Communications	\$ 13,470,050	\$ 13,238,353	\$ 12,615,703	\$ 14,188,933	\$ 14,188,933	\$ 950,580
029 - Habitat Management Program						
Revenue from Use of Money & Property						
4600 - Investment Income	61,767	177,006	74,120	177,006	177,006	-
Total Revenue from Use of Money & Property	\$ 61,767	\$ 177,006	\$ 74,120	\$ 177,006	\$ 177,006	\$ -
Charges for Services						
5750 - Other Services	249,385	-	-	-	-	-
Total Charges for Services	\$ 249,385	\$ -	\$ -	\$ -	\$ -	\$ -
Total 029 - Habitat Management Program	\$ 311,152	\$ 177,006	\$ 74,120	\$ 177,006	\$ 177,006	\$ -
030 - Pension Liability						
Revenue from Use of Money & Property						
4600 - Investment Income	(1,382,646)	-	1,400,000	-	-	-
Total Revenue from Use of Money & Property	\$ (1,382,646)	\$ -	\$ 1,400,000	\$ -	\$ -	\$ -
Charges for Services						
5750 - Other Services	-	-	-	15,227,703	15,227,703	15,227,703
Total Charges for Services	\$ -	\$ -	\$ -	\$ 15,227,703	\$ 15,227,703	\$ 15,227,703
Other Financing Sources						
5940 - Operating Transfers In	9,986,815	15,402,538	30,805,076	-	-	(15,402,538)
Total Revenue from Use of Money & Property	\$ 9,986,815	\$ 15,402,538	\$ 30,805,076	\$ -	\$ -	\$ (15,402,538)
Total 030 - Pension Liability	\$ 8,604,169	\$ 15,402,538	\$ 32,205,076	\$ 15,227,703	\$ 15,227,703	\$ (174,835)
402 - Capital Projects Fund						
Revenue from Use of Money & Property						
4600 - Investment Income	10,600	-	-	-	-	-
Total Revenue from Use of Money & Property	\$ 10,600	\$ -	\$ -	\$ -	\$ -	\$ -
Miscellaneous Revenues						
5855 - Other Reimbursement	154,594	-	-	-	-	-
Total Miscellaneous Revenues	\$ 154,594	\$ -	\$ -	\$ -	\$ -	\$ -
Other Financing Sources						
5940 - Operating Transfers In	1,571,443	-	-	-	-	-
Total Other Financing Sources	\$ 1,571,443	\$ -	\$ -	\$ -	\$ -	\$ -
Total 402 - Capital Projects Fund	\$ 1,736,637	\$ -	\$ -	\$ -	\$ -	\$ -
404 - Capital Projects						
Revenue from Use of Money & Property						
4600 - Investment Income	(30,776)	-	41,673	-	-	-

Source Classification	Actual 2021-22	Adopted Budget 2022-23	Current Year Estimate 2022-23	Requested Budget 2023-24	Recommended Budget 2023-24	Recommended Change From Adopted
Total Revenue from Use of Money & Property	\$ (30,776)	\$ -	\$ 41,673	\$ -	\$ -	\$ -
Intergovernmental Revenues						
5010 - State Aid - Construction Capital Grants	193,413	15,612,894	11,095,308	8,966,850	8,966,850	(6,646,044)
5290 - Federal Aid Other	1,751,986	13,114,453	8,098,324	6,387,370	6,387,370	(6,727,083)
Total Intergovernmental Revenues	\$ 1,945,398	\$ 28,727,347	\$ 19,193,632	\$ 15,354,220	\$ 15,354,220	\$ (13,373,127)
Miscellaneous Revenues						
5855 - Other Reimbursement	205,227	-	-	-	-	-
5870 - Miscellaneous Revenues	72,334	-	6,506	-	-	-
Total Miscellaneous Revenues	\$ 277,561	\$ -	\$ 6,506	\$ -	\$ -	\$ -
Other Financing Sources						
5940 - Operating Transfers In	18,008,498	28,396,296	26,199,966	17,727,256	19,215,256	(9,181,040)
Total Other Financing Sources	\$ 18,008,498	\$ 28,396,296	\$ 26,199,966	\$ 17,727,256	\$ 19,215,256	\$ (9,181,040)
Total 404 - Facility Master Plan Projects	\$ 20,200,682	\$ 57,123,643	\$ 45,441,777	\$ 33,081,476	\$ 34,569,476	\$ (22,554,167)
405 - NGEN Radio Project						
Revenue from Use of Money & Property						
4600 - Investment Income	4,435	-	-	-	-	-
Total Revenue from Use of Money & Property	\$ 4,435	\$ -	\$ -	\$ -	\$ -	\$ -
Other Financing Sources						
5940 - Operating Transfers In	-	538,267	538,267	-	-	(538,267)
Total Other Financing Sources	\$ -	\$ 538,267	\$ 538,267	\$ -	\$ -	\$ (538,267)
Total 405 - NGEN Radio Project	\$ 4,435	\$ 538,267	\$ 538,267	\$ -	\$ -	\$ (538,267)
Grand Total	\$ 1,202,773,816	\$ 1,294,273,751	\$ 1,279,045,639	\$ 1,295,619,212	\$ 1,311,570,394	\$ 17,296,643

Schedule 7

Summary of Financing Uses by Function and Fund Governmental Funds Fiscal Year 2023-24

Description	Actual 2021-22	Adopted Budget 2022-23	Current Year Estimate 2022-23	Requested Budget 2023-24	Recommended Budget 2023-24	Recommended Change From Adopted
Summarization by Function						
GE01 - General	96,994,253	181,672,077	175,067,460	219,707,878	135,154,735	(46,517,342)
PP02 - Public Protection	337,747,533	378,937,700	376,076,322	401,409,316	393,675,979	14,738,279
PW03 - Public Ways & Facilities	46,338,695	77,068,999	64,253,615	76,196,989	76,196,989	(872,010)
HS04 - Health & Sanitation	300,182,449	374,265,947	316,086,339	385,557,216	384,063,090	9,797,143
PA05 - Public Assistance	325,129,221	332,252,849	333,172,236	351,760,791	351,596,353	19,343,504
ED06 - Education	10,890,192	13,690,195	12,846,150	11,893,674	11,893,674	(1,796,521)
RC07 - Recreation & Culture	7,181,597	8,132,737	7,485,938	9,044,329	8,009,201	(123,536)
Sub-Total	\$ 1,124,463,941	\$ 1,366,020,504	\$ 1,284,988,060	\$ 1,455,570,193	\$ 1,360,590,021	\$ (5,430,483)
Total Financing Requirements	\$ 1,124,463,941	\$ 1,366,020,504	\$ 1,284,988,060	\$ 1,455,570,193	\$ 1,360,590,021	\$ (5,430,483)

Schedule 7

County of Monterey Summary of Financing Uses by Function and Fund Governmental Funds Fiscal Year 2023-24

Description	Actual 2021-22	Adopted Budget 2022-23	Current Year Estimate 2022-23	Requested Budget 2023-24	Recommended Budget 2023-24	Recommended Change From Adopted
Summarization by Fund						
001 - General	739,805,061	851,299,613	818,564,970	860,372,475	847,023,424	(4,276,189)
002 - Road Fund	46,338,695	77,068,999	64,253,615	76,196,989	76,196,989	(872,010)
003 - Library Fund	10,484,222	13,138,848	12,362,296	11,410,580	11,410,580	(1,728,268)
005 - In-Home Support Services	817,124	1,018,734	958,749	1,019,853	1,019,853	1,119
006 - Fish & Game Propagation Fund	39,567	52,147	40,834	51,636	51,636	(511)
008 - Community Action Partnership	898,913	519,881	535,857	503,733	503,733	(16,148)
009 - Inclusionary Housing	227,125	120,119	100,342	517,575	517,575	397,456
011 - Revolving Loan Fund	511,873	1,150,500	1,150,500	1,150,500	1,150,500	-
013 - Community Development Fund	2,502,556	8,883,604	5,893,754	7,114,351	7,114,351	(1,769,253)
016 - Emergency Medical Service Fund	403,045	603,000	621,889	708,900	708,900	105,900
021 - Workforce Development Board	8,496,290	8,681,924	8,391,372	10,470,579	10,430,579	1,748,655
022 - Local Revenue Fund	69,422,519	86,679,486	87,724,507	97,332,470	97,332,470	10,652,984
023 - Behavioral Health	145,663,784	157,398,704	144,011,754	166,379,440	166,379,440	8,980,736
024 - Homeland Security Grant	529,162	1,645,959	1,660,959	1,151,231	1,151,231	(494,728)
025 - H&W Realignment	64,955,430	66,709,183	65,939,489	75,220,982	75,220,982	8,511,799
026 - NGEN Operations & Maintenance	735,715	1,606,116	1,606,116	881,062	881,062	(725,054)
027 - County Clerk/Recorder	282,823	400,000	708,819	426,000	426,000	26,000
028 - Emergency Communications	11,741,600	12,909,353	12,891,697	14,734,982	14,734,982	1,825,629
029 - Habitat Management Program	188,801	545,625	211,008	253,650	253,650	(291,975)
030 - Pension Liability	45,859	-	250,000	300,000	300,000	300,000
402 - Capital Projects Fund	4,105,694	-	-	-	-	-
404 - Capital Projects	16,268,083	74,052,709	55,573,533	129,373,205	47,782,084	(26,270,625)
405 - NGEN Radio Project	-	1,536,000	1,536,000	-	-	(1,536,000)
Total Financing Requirements	\$ 1,124,463,941	\$ 1,366,020,504	\$ 1,284,988,060	\$ 1,455,570,193	\$ 1,360,590,021	\$ (5,430,483)

Schedule 8

County of Monterey Detail of Financing Uses by Function, Activity and Budget Unit Governmental Funds Fiscal Year 2023-24

Function and Activity	Actual 2021-22	Adopted Budget 2022-23	Current Year Estimate 2022-23	Requested Budget 2023-24	Recommended Budget 2023-24	Recommended Change From Adopted
General						
Administration						
Housing and Community Development	2,506,780	3,993,238	4,033,835	4,214,434	4,094,434	101,196
Public Works, Facilities & Parks	3,922,545	4,095,869	4,123,610	644,214	644,214	(3,451,655)
Total Administration	\$ 6,429,325	\$ 8,089,107	\$ 8,157,445	\$ 4,858,648	\$ 4,738,648	\$ (3,350,459)
Contingencies						
County Administrative Office	-	7,398,322	541,260	7,933,546	7,933,546	535,224
Total Contingencies	\$ -	\$ 7,398,322	\$ 541,260	\$ 7,933,546	\$ 7,933,546	\$ 535,224
Legislative & Administrative						
Auditor-Controller	(6,830)	118,885	118,885	216,380	216,380	97,495
Board of Supervisors	4,378,314	4,795,331	4,692,219	4,958,011	4,958,011	162,680
Clerk of the Board	916,246	1,155,754	1,049,273	1,207,047	1,207,047	51,293
County Administrative Office	5,641,328	7,991,321	7,995,828	9,701,654	9,123,649	1,132,328
Total Legislative & Administrative	\$ 10,929,059	\$ 14,061,291	\$ 13,856,205	\$ 16,083,092	\$ 15,505,087	\$ 1,443,796
Other Financing Uses						
County Administrative Office	29,617,287	49,581,916	54,656,532	19,144,381	20,632,381	(28,949,535)
Total Other Financing Uses	\$ 29,617,287	\$ 49,581,916	\$ 54,656,532	\$ 19,144,381	\$ 20,632,381	\$ (28,949,535)
Finance						
Assessor-County Clerk-Recorder	7,139,990	7,731,268	7,687,871	8,223,344	7,886,673	155,405
Auditor-Controller	962,165	1,788,784	1,473,378	2,631,274	2,083,049	294,265
County Administrative Office	(1,211,850)	(740,870)	(527,886)	(572,666)	(743,868)	(2,998)
Treasurer-Tax Collector	7,278,438	9,514,514	8,172,068	9,928,945	9,928,945	414,431
Total Finance	\$ 14,168,743	\$ 18,293,696	\$ 16,805,431	\$ 20,210,897	\$ 19,154,799	\$ 861,103
Counsel						
County Counsel	1,885,434	1,209,263	1,077,381	1,558,167	1,558,167	348,904
Total Counsel	\$ 1,885,434	\$ 1,209,263	\$ 1,077,381	\$ 1,558,167	\$ 1,558,167	\$ 348,904
Housing Successor Agencies						
Housing and Community Development	227,125	120,119	100,342	517,575	517,575	397,456
Total Housing Successor Agencies	\$ 227,125	\$ 120,119	\$ 100,342	\$ 517,575	\$ 517,575	\$ 397,456
Personnel						
Civil Rights Office	(60,001)	381,261	313,144	421,997	407,997	26,736
Human Resources	796,291	1,470,406	1,124,517	1,111,032	669,827	(800,579)
Total Personnel	\$ 736,290	\$ 1,851,667	\$ 1,437,661	\$ 1,533,029	\$ 1,077,824	\$ (773,843)
Elections						
Elections	6,544,109	5,523,076	5,518,578	6,680,343	6,578,144	1,055,068
Total Elections	\$ 6,544,109	\$ 5,523,076	\$ 5,518,578	\$ 6,680,343	\$ 6,578,144	\$ 1,055,068
Communications						
Emergency Communications	11,741,600	12,909,353	12,891,697	14,734,982	14,734,982	1,825,629
Total Communications	\$ 11,741,600	\$ 12,909,353	\$ 12,891,697	\$ 14,734,982	\$ 14,734,982	\$ 1,825,629
Property Management						
Public Works, Facilities & Parks	5,533,996	4,471,609	5,396,467	7,672,828	5,534,313	1,062,704
Total Property Management	\$ 5,533,996	\$ 4,471,609	\$ 5,396,467	\$ 7,672,828	\$ 5,534,313	\$ 1,062,704
Plant Acquisition						
Emergency Communications	735,715	1,606,116	1,606,116	881,062	881,062	(725,054)
Information Technology	-	-	-	1,488,000	1,488,000	1,488,000
Public Works, Facilities & Parks	12,231,028	49,052,709	48,573,533	107,896,682	26,305,561	(22,747,148)
Total Plant Acquisition	\$ 12,966,743	\$ 50,658,825	\$ 50,179,649	\$ 110,265,744	\$ 28,674,623	\$ (21,984,202)
Promotion						
County Administrative Office	3,454,664	6,231,129	3,752,000	3,722,000	3,722,000	(2,509,129)
Total Promotion	\$ 3,454,664	\$ 6,231,129	\$ 3,752,000	\$ 3,722,000	\$ 3,722,000	\$ (2,509,129)
Other Agencies						
Emergency Communications	-	1,536,000	1,536,000	-	-	(1,536,000)
Total Other Agencies	\$ -	\$ 1,536,000	\$ 1,536,000	\$ -	\$ -	\$ (1,536,000)
Other General						
County Administrative Office	(883,661)	314,818	300,674	251,125	251,125	(63,693)

Function and Activity	Actual 2021-22	Adopted Budget 2022-23	Current Year Estimate 2022-23	Requested Budget 2023-24	Recommended Budget 2023-24	Recommended Change From Adopted
County Counsel	145,086	206,905	11,309	50,000	50,000	(156,905)
Information Technology	(6,501,545)	(680,701)	(1,052,236)	4,668,043	4,668,043	5,348,744
Public Works, Facilities & Parks	-	(104,318)	(98,935)	(176,522)	(176,522)	(72,204)
Total Other General	\$ (7,240,120)	\$ (263,296)	\$ (839,188)	\$ 4,792,646	\$ 4,792,646	\$ 5,055,942
Total General	\$ 96,994,253	\$ 181,672,077	\$ 175,067,460	\$ 219,707,878	\$ 135,154,735	\$ (46,517,342)
Public Protection						
Judicial						
Child Support Services	11,095,444	11,646,776	11,301,584	12,163,694	12,163,694	516,918
County Administrative Office	7,971,665	8,937,113	7,963,192	8,288,269	8,288,269	(648,844)
County Counsel	439,068	342,952	334,582	324,844	324,844	(18,108)
District Attorney	37,149,466	40,077,453	38,098,960	42,768,081	41,454,016	1,376,563
Public Defender	15,952,229	19,146,126	19,169,779	18,962,984	18,962,984	(183,142)
Total Judicial	\$ 72,607,872	\$ 80,150,420	\$ 76,868,097	\$ 82,507,872	\$ 81,193,807	\$ 1,043,387
Police Protection						
Sheriff-Coroner	56,029,571	61,335,234	62,674,619	67,157,842	64,787,973	3,452,739
Total Police Protection	\$ 56,029,571	\$ 61,335,234	\$ 62,674,619	\$ 67,157,842	\$ 64,787,973	\$ 3,452,739
Detention & Correction						
Probation	78,273,535	96,387,828	96,452,110	101,980,824	101,878,720	5,490,892
Sheriff-Coroner	78,886,958	86,187,213	89,260,475	94,420,472	92,946,193	6,758,980
Total Detention & Correction	\$ 157,160,493	\$ 182,575,041	\$ 185,712,585	\$ 196,401,296	\$ 194,824,913	\$ 12,249,872
Protection Inspection						
Agricultural Commissioner	12,967,003	13,038,300	12,813,092	13,735,191	13,735,191	696,891
Total Protection Inspection	\$ 12,967,003	\$ 13,038,300	\$ 12,813,092	\$ 13,735,191	\$ 13,735,191	\$ 696,891
Other Protection						
Assessor-County Clerk-Recorder	5,209,997	3,299,594	3,519,060	3,031,996	2,929,997	(369,597)
County Administrative Office	14,023,814	12,714,149	10,452,546	5,509,334	5,490,334	(7,223,815)
Department of Emergency Management	-	-	-	4,711,683	4,396,683	4,396,683
Health	5,896,998	7,926,065	7,898,621	9,471,165	8,456,190	530,125
Housing and Community Development	12,558,263	16,052,753	14,790,008	16,780,736	15,758,690	(294,063)
Public Works, Facilities & Parks	1,293,522	1,846,144	1,347,694	2,102,201	2,102,201	256,057
Total Other Protection	\$ 38,982,594	\$ 41,838,705	\$ 38,007,929	\$ 41,607,115	\$ 39,134,095	\$ (2,704,610)
Total Public Protection	\$ 337,747,533	\$ 378,937,700	\$ 376,076,322	\$ 401,409,316	\$ 393,675,979	\$ 14,738,279
Public Ways & Facilities						
Public Ways						
Public Works, Facilities & Parks	46,338,695	77,068,999	64,253,615	76,196,989	76,196,989	(872,010)
Total Public Ways	\$ 46,338,695	\$ 77,068,999	\$ 64,253,615	\$ 76,196,989	\$ 76,196,989	\$ (872,010)
Total Public Ways & Facilities	\$ 46,338,695	\$ 77,068,999	\$ 64,253,615	\$ 76,196,989	\$ 76,196,989	\$ (872,010)
Health & Sanitation						
Health						
Health	282,505,929	339,116,782	299,009,367	355,305,450	353,811,324	14,694,542
Total Health	\$ 282,505,929	\$ 339,116,782	\$ 299,009,367	\$ 355,305,450	\$ 353,811,324	\$ 14,694,542
Hospital Care						
County Administrative Office	3,900,648	3,900,648	3,900,648	3,900,648	3,900,648	-
Health	840,146	922,694	1,090,583	956,031	956,031	33,337
Total Hospital Care	\$ 4,740,794	\$ 4,823,342	\$ 4,991,231	\$ 4,856,679	\$ 4,856,679	\$ 33,337
California Childrens Services						
Health	4,659,804	5,176,413	4,957,463	5,245,728	5,245,728	69,315
Total California Childrens Services	\$ 4,659,804	\$ 5,176,413	\$ 4,957,463	\$ 5,245,728	\$ 5,245,728	\$ 69,315
Enterprise Fund						
Natividad Medical Center	8,142,749	25,000,000	7,000,000	20,000,000	20,000,000	(5,000,000)
Total Enterprise Fund	\$ 8,142,749	\$ 25,000,000	\$ 7,000,000	\$ 20,000,000	\$ 20,000,000	\$ (5,000,000)
Sanitation						
Public Works, Facilities & Parks	133,172	149,410	128,278	149,359	149,359	(51)
Total Sanitation	\$ 133,172	\$ 149,410	\$ 128,278	\$ 149,359	\$ 149,359	\$ (51)
Total Health & Sanitation	\$ 300,182,449	\$ 374,265,947	\$ 316,086,339	\$ 385,557,216	\$ 384,063,090	\$ 9,797,143

Schedules

Function and Activity	Actual 2021-22	Adopted Budget 2022-23	Current Year Estimate 2022-23	Requested Budget 2023-24	Recommended Budget 2023-24	Recommended Change From Adopted
Public Assistance						
Administration						
Social Services	176,368,301	198,349,006	189,432,785	205,057,264	205,057,264	6,708,258
Total Administration	\$ 176,368,301	\$ 198,349,006	\$ 189,432,785	\$ 205,057,264	\$ 205,057,264	\$ 6,708,258
Aid Programs						
Social Services	70,626,219	77,918,964	82,063,705	88,631,093	88,631,093	10,712,129
Total Aid Programs	\$ 70,626,219	\$ 77,918,964	\$ 82,063,705	\$ 88,631,093	\$ 88,631,093	\$ 10,712,129
General Relief						
Social Services	496,077	1,064,495	894,564	881,475	779,355	(285,140)
Total General Relief	\$ 496,077	\$ 1,064,495	\$ 894,564	\$ 881,475	\$ 779,355	\$ (285,140)
Veteran's Services						
Social Services	2,427,387	2,175,989	2,138,888	2,378,240	2,355,922	179,933
Total Veteran's Services	\$ 2,427,387	\$ 2,175,989	\$ 2,138,888	\$ 2,378,240	\$ 2,355,922	\$ 179,933
Other Assistance						
County Administrative Office	9,008,163	9,832,424	9,541,872	11,621,079	11,581,079	1,748,655
Housing and Community Development	2,502,556	8,883,604	5,893,754	7,114,351	7,114,351	(1,769,253)
Social Services	63,700,519	34,028,367	43,206,668	36,077,289	36,077,289	2,048,922
Total Other Assistance	\$ 75,211,238	\$ 52,744,395	\$ 58,642,294	\$ 54,812,719	\$ 54,772,719	\$ 2,028,324
Total Public Assistance	\$ 325,129,221	\$ 332,252,849	\$ 333,172,236	\$ 351,760,791	\$ 351,596,353	\$ 19,343,504
Education						
Library Services						
Library	10,484,222	13,138,848	12,362,296	11,410,580	11,410,580	(1,728,268)
Total Library Services	\$ 10,484,222	\$ 13,138,848	\$ 12,362,296	\$ 11,410,580	\$ 11,410,580	\$ (1,728,268)
Agriculture Education						
Cooperative Extension Service	405,970	551,347	483,854	483,094	483,094	(68,253)
Total Agriculture Education	\$ 405,970	\$ 551,347	\$ 483,854	\$ 483,094	\$ 483,094	\$ (68,253)
Total Education	\$ 10,890,192	\$ 13,690,195	\$ 12,846,150	\$ 11,893,674	\$ 11,893,674	\$ (1,796,521)
Recreation & Culture						
Recreation Facilities						
County Administrative Office	209,126	-	-	-	-	-
Public Works, Facilities & Parks	6,972,471	8,132,737	7,485,938	9,044,329	8,009,201	(123,536)
Total Recreation Facilities	\$ 7,181,597	\$ 8,132,737	\$ 7,485,938	\$ 9,044,329	\$ 8,009,201	\$ (123,536)
Total Recreation & Culture	\$ 7,181,597	\$ 8,132,737	\$ 7,485,938	\$ 9,044,329	\$ 8,009,201	\$ (123,536)
Grand Total	\$1,124,463,941	\$1,366,020,504	\$1,284,988,060	\$1,455,570,193	\$1,360,590,021	\$ (5,430,483)

Schedule 12

County of Monterey Special Districts and Other Agencies Summary Fiscal Year 2023-24

Fund Code	Fund Name and District/Agency Name	Total Financing Sources				Total Financing Uses			
		Fund Balance Available	Decreases to Obligated Fund Balance	Additional Financing Sources	Total Financing Sources	Financing Uses	Increases to Obligated Fund Balance	Total Financing Uses	Ending Available Fund Balance
County Services Areas									
051	CSA #1 Carmel Point	235,727	-	43,233	278,960	106,211	-	106,211	172,749
052	CSA #9 Oak Park	415,789	-	58,882	474,671	200,732	-	200,732	273,939
053	CSA #10 Laguna Seca Ranch	168,103	-	850	168,953	33,791	-	33,791	135,162
054	CSA #14 Moro Cojo	(51)	-	-	(51)	-	-	-	(51)
055	CSA #14 Castroville	12,847	-	-	12,847	-	-	-	12,847
056	CSA #15 Serra Vilge, Toro Park	170,130	-	201,960	372,090	300,470	-	300,470	71,620
057	CSA #17 Rancho Terra Grande	(9,415)	-	16,340	6,925	18,592	-	18,592	(11,667)
058	CSA #19 Carmel Meadows	16,200	-	873	17,073	4,333	-	4,333	12,740
059	CSA #20 Royal Estates	81,473	-	7,475	88,948	22,633	-	22,633	66,315
060	CSA #23 Carmel Rancho	282,952	-	15,580	298,532	76,559	-	76,559	221,973
061	CSA #24 Pedrazzi Subdivision	84,713	-	6,571	91,284	67,078	-	67,078	24,206
062	CSA #25 Carmel V Country Club	177,105	-	46,314	223,419	77,227	-	77,227	146,192
063	CSA #26 New Moss Landing Hgts	84,182	-	5,540	89,722	20,041	-	20,041	69,681
064	CSA #30 Rancho Mar Monte	29,115	-	1,673	30,788	7,997	-	7,997	22,791
065	CSA #31 Aromas Hills	42,087	-	1,684	43,771	10,590	-	10,590	33,181
066	CSA #32 Green Valley Acres	58,057	-	9,659	67,716	18,855	-	18,855	48,861
067	CSA #33 Coast Ridge Subdivisn	25,636	-	3,312	28,948	10,515	-	10,515	18,433
068	CSA #34 Rancho Rio Vista	11,309	-	2,514	13,823	7,781	-	7,781	6,042
069	CSA #35 Paradise Park	86,004	-	12,151	98,155	26,203	-	26,203	71,952
070	CSA #37 Colonial Oak Estates	17,499	-	948	18,447	5,824	-	5,824	12,623
071	CSA #38 Paradise Lake Estates	66,439	-	2,773	69,212	15,686	-	15,686	53,526
072	CSA #41 Gabilan Acres	213,462	-	21,667	235,129	59,670	-	59,670	175,459
073	CSA #44 Corral De Tierra	55,337	-	7,234	62,571	42,119	-	42,119	20,452
074	CSA #45 Oak Hills	154,264	-	33,076	187,340	85,360	-	85,360	101,980
075	CSA #45-Oak Hills - Open Space	681	-	19,935	20,616	23,454	-	23,454	(2,838)
076	CSA #47 Carmel Views	24,235	-	27,705	51,940	37,630	-	37,630	14,310
077	CSA #50 Rioway Track	1,098,290	-	610,413	1,708,703	1,303,180	-	1,303,180	405,523
078	CSA #51 High Meadow	163,367	-	20,700	184,067	85,513	-	85,513	98,554
079	CSA #52 Cerro Del Oso	206,204	-	8,167	214,371	94,487	-	94,487	119,884
080	CSA #53 Arroyo Seco	17,765	-	11,239	29,004	25,956	-	25,956	3,048
081	CSA #54 Manzanita	31,965	-	1,720	33,685	10,306	-	10,306	23,379
082	CSA #55 Buena Vista Del Sol	191,368	-	10,563	201,931	84,031	-	84,031	117,900
083	CSA #56 Del Mesa Carmel	254,529	-	11,201	265,730	56,723	-	56,723	209,007
084	CSA #57 Los Tulares	33,328	-	2,179	35,507	9,466	-	9,466	26,041
085	CSA #58 Vista Colorado	69,475	-	4,305	73,780	15,837	-	15,837	57,943
086	CSA #62 Rancho Del Monte	306,330	-	14,721	321,051	66,639	-	66,639	254,412
087	CSA #66 Oak Tree Views	42,976	-	26,441	69,417	51,003	-	51,003	18,414
088	CSA #67 Corral De Tierra Oaks	3,403,672	-	134,851	3,538,523	715,066	-	715,066	2,823,457
089	CSA #68 Vierra Canyon	91,453	-	2,554	94,007	21,146	-	21,146	72,861
090	CSA #69 Ralph Lane	1,154	-	10	1,164	288	-	288	876
091	CSA #72 Las Palmas Ranch	86,695	-	5,410	92,105	80,955	-	80,955	11,150
092	CSA #74 Ambulance	3,578,214	-	1,865,000	5,443,214	2,337,495	-	2,337,495	3,105,719
093	CSA #75 Chualar Consolidated	223,002	-	181,252	404,254	274,485	-	274,485	129,769
Total County Service Areas		\$ 12,303,667	\$ -	\$ 3,458,675	\$ 15,762,342	\$ 6,511,927	\$ -	\$ 6,511,927	\$ 9,250,415
County Sanitation Districts									
151	Pajaro Co Sanitation District	1,216,346	-	1,979,742	3,196,088	2,933,571	-	2,933,571	262,517
154	Carmel Valley San Zone # 2 Dst	17,665	-	300	17,965	-	-	-	17,965
156	Boronda Co Sanitation Dist	4,977	-	160,096	165,073	166,662	-	166,662	(1,589)
157	Boronda Csd-Zone 2-San Jerardo	190,798	-	82,751	273,549	190,165	-	190,165	83,384
305	Boronda Co Sanitation Sewer	652	-	-	652	-	-	-	652
306	Boronda Co. San Sewer	7,834	-	39,055	46,889	38,600	-	38,600	8,289
310	Pajaro Co San Sewer	58,202	-	-	58,202	-	-	-	58,202
312	Chualar Co Water Ser	15,095	-	15,517	30,612	15,924	-	15,924	14,688
Total County Sanitation Districts		\$ 1,511,569	\$ -	\$ 2,277,461	\$ 3,789,030	\$ 3,344,922	\$ -	\$ 3,344,922	\$ 444,108
Housing Successor Agencies									
175	Castroville-Pajaro Housing Successor	1,541,307	-	302,140	1,843,447	355,000	-	355,000	1,488,447
176	Boronda Housing Successor	534,349	-	-	534,349	-	-	-	534,349
Total Housing Successor Agencies		\$ 2,075,656	\$ -	\$ 302,140	\$ 2,377,796	\$ 355,000	\$ -	\$ 355,000	\$ 2,022,796
Other Agencies									
251	Public Improvement Corp Debt Service	-	-	15,480,525	15,480,525	15,480,525	-	15,480,525	-
Total Other Agencies		\$ -	\$ -	\$ 15,480,525	\$ 15,480,525	\$ 15,480,525	\$ -	\$ 15,480,525	\$ -

Schedules

Schedule 12
County of Monterey
Special Districts and Other Agencies Summary
Fiscal Year 2023-24

Fund Code	Fund Name and District/Agency Name	Total Financing Sources				Total Financing Uses			
		Fund Balance Available	Decreases to Obligated Fund Balance	Additional Financing Sources	Total Financing Sources	Financing Uses	Increases to Obligated Fund Balance	Total Financing Uses	Ending Available Fund Balance
Other Districts									
	180 E. Garrison Public Financing Authority	144,568	-	16,683	161,251	36,125	-	36,125	125,126
	181 E. Garrison Community Facility District	2,366,007	-	1,768,150	4,134,157	1,997,520	-	1,997,520	2,136,637
	182 E. Garrison Developer Reimbursements	1,055	-	136,000	137,055	135,000	-	135,000	2,055
	Total Other Districts	\$ 2,511,630	\$ -	\$ 1,920,833	\$ 4,432,463	\$ 2,168,645	\$ -	\$ 2,168,645	\$ 2,263,818
	Total Special Districts and Other Agencies	\$ 18,402,522	\$ -	\$ 23,439,634	\$ 41,842,156	\$ 27,861,019	\$ -	\$ 27,861,019	\$ 13,981,137

County of Monterey
Analysis of Revenue by Fund
All Funds
Fiscal Year 2023-24

Source Classification	Actual 2021-22	Adopted Budget 2022-23	Current Year Estimate 2022-23	Requested Budget 2023-24	Recommended Budget 2023-24	Recommended Change From Adopted
Summarization by Fund						
001 - General	761,692,381	793,354,612	786,638,351	821,749,940	836,213,122	42,858,510
002 - Road Fund	42,778,696	79,607,646	66,036,485	61,572,791	61,572,791	(18,034,855)
003 - Library Fund	11,375,893	13,003,540	12,933,540	11,644,157	11,644,157	(1,359,383)
005 - In-Home Support Services	804,236	1,018,734	958,749	1,019,853	1,019,853	1,119
006 - Fish & Game Propagation Fund	49,498	49,021	51,914	45,029	45,029	(3,992)
008 - Community Action Partnership	886,253	519,881	535,857	503,733	503,733	(16,148)
009 - Inclusionary Housing	57,593	102,869	23,000	22,500	22,500	(80,369)
011 - Revolving Loan Fund	1,649,771	150,400	152,623	150,400	150,400	-
013 - Community Development Fund	2,497,883	7,459,745	4,603,023	4,178,141	4,178,141	(3,281,604)
016 - Emergency Medical Service Fund	675,866	935,000	843,900	748,900	748,900	(186,100)
021 - Workforce Development Board	8,905,593	8,681,924	8,681,924	10,430,579	10,430,579	1,748,655
022 - Local Revenue Fund	88,211,346	83,670,169	94,508,466	93,536,370	93,536,370	9,866,201
023 - Behavioral Health	158,294,653	150,279,106	139,961,602	159,522,461	159,522,461	9,243,355
024 - Homeland Security Grant	25,827	1,645,959	1,660,959	1,151,231	1,151,231	(494,728)
025 - H&W Realignment	76,449,297	65,847,489	68,903,635	65,360,947	65,360,947	(486,542)
026 - NGEN Operations & Maintenance	1,094,542	1,067,849	1,067,849	881,062	881,062	(186,787)
027 - County Clerk/Recorder	2,999,895	400,000	708,819	426,000	426,000	26,000
028 - Emergency Communications	13,470,050	13,238,353	12,615,703	14,188,933	14,188,933	950,580
029 - Habitat Management Program	311,152	177,006	74,120	177,006	177,006	-
030 - Pension Liability	8,604,169	15,402,538	32,205,076	15,227,703	15,227,703	(174,835)
051 - CSA #1 Carmel Point	43,151	42,120	42,120	43,233	43,233	1,113
052 - CSA #9 Oak Park	56,116	57,548	57,548	58,882	58,882	1,334
053 - CSA #10 Laguna Seca Ranch	743	850	850	850	850	-
056 - CSA #15 Serra Village, Toro Park	202,767	197,093	197,093	201,960	201,960	4,867
057 - CSA #17 Rancho Tierra Grande	15,955	15,098	15,940	16,340	16,340	1,242
058 - CSA #19 Carmel Meadows	856	861	861	873	873	12
059 - CSA #20 Royal Estates	7,583	7,407	7,407	7,475	7,475	68
060 - CSA #23 Carmel Rancho	15,625	15,513	15,513	15,580	15,580	67
061 - CSA #24 Pedrazzi Subdivision/Indian Springs	6,347	6,548	6,548	6,571	6,571	23
062 - CSA#25 Carmel Valley Golf & County Club	50,723	45,084	44,907	46,314	46,314	1,230
063 - CSA #26 New Moss Landing Heights	5,814	5,462	5,370	5,540	5,540	78
064 - CSA #30 Rancho Mar Monte	1,653	1,659	1,581	1,673	1,673	14
065 - CSA #31 Aromas Hills Subdivision	1,659	1,671	1,599	1,684	1,684	13
066 - CSA #32 Green Valley Acres/Moon Subdivision	9,847	9,546	9,461	9,659	9,659	113
067 - CSA #33 Coast Ridge/Carmel Sur	3,383	3,256	3,168	3,312	3,312	56
068 - CSA #34 Rancho Rio Vista/Carmel Knolls	2,808	2,447	2,433	2,514	2,514	67
069 - CSA #35 Paradise Park	11,997	11,972	11,889	12,151	12,151	179
070 - CSA #37 Colonial Oak Estates	872	948	930	948	948	-
071 - CSA #38 Paradise Lake Estates	2,694	2,740	2,609	2,773	2,773	33
072 - CSA #41 Gabilan Acres/Boronda	23,077	21,664	21,221	21,667	21,667	3
073 - CSA #44 Corral De Tierra Oaks 1/2/3	7,184	7,114	7,057	7,234	7,234	120
074 - CSA #45 Oak Hills	34,304	33,137	32,494	33,076	33,076	(61)
075 - CSA #45-Oak Hills - Open Space	19,642	19,929	19,234	19,935	19,935	6
076 - CSA #47 Carmel Views/Mar Vista	28,648	27,119	26,951	27,705	27,705	586
077 - CSA #50 Rioway Tract No. 2	124,856	610,379	124,280	610,413	610,413	34
078 - CSA #51 High Meadow	20,200	20,347	20,109	20,700	20,700	353
079 - CSA #52 Carmel Valley Village	8,326	8,024	7,838	8,167	8,167	143
080 - CSA #53 Arroyo Seco	10,146	10,943	10,943	11,239	11,239	296
081 - CSA #54 Manzanita/Sarsi Subdivisions	1,771	1,684	1,684	1,720	1,720	36
082 - CSA #55 Robles Del Rio	11,094	10,296	10,296	10,563	10,563	267
083 - CSA #56 Del Mesa Carmel	10,993	11,141	11,141	11,201	11,201	60
084 - CSA #57 Los Tulares Subdivision	2,443	2,124	2,124	2,179	2,179	55
085 - CSA #58 Vista Dorado	4,147	4,234	4,234	4,305	4,305	71
086 - CSA #62 Rancho Del Monte 14	15,265	14,427	14,427	14,721	14,721	294
087 - CSA #66 Oak Tree Views	26,527	26,441	26,441	26,441	26,441	-
088 - CSA #67 Corral De Tierra Oaks 4	123,110	131,512	131,512	134,851	134,851	3,339
089 - CSA #68 Vierra Canyon Knolls	2,497	2,554	2,554	2,554	2,554	-
090 - CSA #69 Ralph Lane	6	10	14	10	10	-
091 - CSA #72 Las Palmas Ranch	5,256	5,410	5,410	5,410	5,410	-
092 - CSA #74 Ambulance	1,880,085	1,850,000	1,873,000	1,865,000	1,865,000	15,000
093 - CSA #75 Chualar Consolidated	251,586	180,442	180,442	181,252	181,252	810
151 - Pajaro Co Sanitation District	1,257,624	911,462	3,310,862	819,579	1,979,742	1,068,280
154 - Carmel Valley San Zone # 2 Dst	77	300	300	300	300	-
156 - Boronda Co Sanitation Dist	187,136	160,096	160,096	160,096	160,096	-

Schedules

Source Classification	Actual 2021-22	Adopted Budget 2022-23	Current Year Estimate 2022-23	Requested Budget 2023-24	Recommended Budget 2023-24	Recommended Change From Adopted
157 - San Jerardo CSD	127,230	82,751	219,751	82,751	82,751	-
175 - Castroville-Pajaro Housing Successor	456,139	302,200	340,900	302,140	302,140	(60)
176 - Boronda Housing Successor	59	-	-	-	-	-
180 - East Garrison Community Facility District	815	40,750	16,000	16,683	16,683	(24,067)
181 - East Garrison Community Services District	1,687,837	1,867,567	1,717,000	1,768,150	1,768,150	(99,417)
182 - East Garrison Developer Reimbursements	2,912	130,000	513,000	136,000	136,000	6,000
251 - Public Improvement Corp Debt Service	15,988,869	15,978,525	15,978,525	15,480,525	15,480,525	(498,000)
306 - Boronda Co San Revenue Bonds	38,386	38,705	38,705	39,055	39,055	350
310 - Pajaro Co San Sewer Revenue	259	-	-	-	-	-
312 - Chualar Co Water Ser A	15,017	15,517	15,067	15,517	15,517	-
402 - Capital Projects Fund	1,736,637	-	-	-	-	-
404 - Capital Projects	20,200,682	57,123,643	45,441,777	33,081,476	34,569,476	(22,554,167)
405 - NGEN Radio Project	4,435	538,267	538,267	-	-	(538,267)
451 - Natividad Medical Center	493,593,551	384,650,960	404,393,676	412,886,422	412,886,422	28,235,462
452 - Parks Lake & Resort Operations	3,976,265	4,603,639	3,271,332	3,936,796	3,936,796	(666,843)
453 - Laguna Seca Recreational Area	20,283,889	18,044,645	16,982,410	27,031,008	27,031,008	8,986,363
475 - General Liability Fund	21,702,996	21,666,611	20,999,051	22,465,788	22,465,788	799,177
476 - Worker's Comp Fund	27,394,697	26,185,000	24,329,875	26,500,000	26,500,000	315,000
477 - Benefit Programs Fund	11,457,407	11,668,230	10,766,525	12,528,549	12,528,549	860,319
478 - Resource Planning	8,496,357	7,943,736	8,456,085	8,374,018	8,374,018	430,282
Grand Total	\$ 1,812,495,629	\$ 1,791,991,199	\$ 1,793,616,032	\$ 1,831,621,264	\$ 1,848,732,609	\$ 56,741,410

County of Monterey
Analysis of Expenditures by Fund
All Funds
Fiscal Year 2023-24

Source Classification	Actual 2021-22	Adopted Budget 2022-23	Current Year Estimate 2022-23	Requested Budget 2023-24	Recommended Budget 2023-24	Recommended Change From Adopted
Summarization by Fund						
001 - General	739,805,061	851,299,613	818,564,970	860,372,475	847,023,424	(4,276,189)
002 - Road Fund	46,338,695	77,068,999	64,253,615	76,196,989	76,196,989	(872,010)
003 - Library Fund	10,484,222	13,138,848	12,362,296	11,410,580	11,410,580	(1,728,268)
005 - In-Home Support Services	817,124	1,018,734	958,749	1,019,853	1,019,853	1,119
006 - Fish & Game Propagation Fund	39,567	52,147	40,834	51,636	51,636	(511)
008 - Community Action Partnership	898,913	519,881	535,857	503,733	503,733	(16,148)
009 - Inclusionary Housing	227,125	120,119	100,342	517,575	517,575	397,456
011 - Revolving Loan Fund	511,873	1,150,500	1,150,500	1,150,500	1,150,500	-
013 - Community Development Fund	2,502,556	8,883,604	5,893,754	7,114,351	7,114,351	(1,769,253)
016 - Emergency Medical Service Fund	403,045	603,000	621,889	708,900	708,900	105,900
021 - Workforce Development Board	8,496,290	8,681,924	8,391,372	10,470,579	10,430,579	1,748,655
022 - Local Revenue Fund	69,422,519	86,679,486	87,724,507	97,332,470	97,332,470	10,652,984
023 - Behavioral Health	145,663,784	157,398,704	144,011,754	166,379,440	166,379,440	8,980,736
024 - Homeland Security Grant	529,162	1,645,959	1,660,959	1,151,231	1,151,231	(494,728)
025 - H&W Realignment	64,955,430	66,709,183	65,939,489	75,220,982	75,220,982	8,511,799
026 - NGEN Operations & Maintenance	735,715	1,606,116	1,606,116	881,062	881,062	(725,054)
027 - County Clerk/Recorder	282,823	400,000	708,819	426,000	426,000	26,000
028 - Emergency Communications	11,741,600	12,909,353	12,891,697	14,734,982	14,734,982	1,825,629
029 - Habitat Management Program	188,801	545,625	211,008	253,650	253,650	(291,975)
030 - Pension Liability	45,859	-	250,000	300,000	300,000	300,000
051 - CSA #1 Carmel Point	16,520	67,205	14,852	106,211	106,211	39,006
052 - CSA #9 Oak Park	20,397	201,221	71,851	200,732	200,732	(489)
053 - CSA #10 Laguna Seca Ranch	140	33,639	-	33,791	33,791	152
056 - CSA #15 Serra Village, Toro Park	179,963	272,345	276,971	300,470	300,470	28,125
057 - CSA #17 Rancho Tierra Grande	28,150	17,447	30,614	18,592	18,592	1,145
058 - CSA #19 Carmel Meadows	1,773	6,650	1,542	4,333	4,333	(2,317)
059 - CSA #20 Royal Estates	5,085	23,017	4,254	22,633	22,633	(384)
060 - CSA #23 Carmel Rancho	3,187	65,382	8,160	76,559	76,559	11,177
061 - CSA #24 Pedrazzi Subdivision/Indian Springs	83,522	8,052	5,265	67,078	67,078	59,026
062 - CSA#25 Carmel Valley Golf & County Club	26,220	66,664	42,234	77,227	77,227	10,563
063 - CSA #26 New Moss Landing Heights	3,021	20,825	2,182	20,041	20,041	(784)
064 - CSA #30 Rancho Mar Monte	1,539	8,976	1,854	7,997	7,997	(979)
065 - CSA #31 Aromas Hills Subdivision	1,815	11,822	1,849	10,590	10,590	(1,232)
066 - CSA #32 Green Valley Acres/Moon Subdivision	7,082	19,684	5,663	18,855	18,855	(829)
067 - CSA #33 Coast Ridge/Carmel Sur	2,704	15,719	5,070	10,515	10,515	(5,204)
068 - CSA #34 Rancho Rio Vista/Carmel Knolls	703	2,622	2,180	7,781	7,781	5,159
069 - CSA #35 Paradise Park	7,336	26,770	6,945	26,203	26,203	(567)
070 - CSA #37 Colonial Oak Estates	1,573	8,342	2,150	5,824	5,824	(2,518)
071 - CSA #38 Paradise Lake Estates	1,587	17,266	1,859	15,686	15,686	(1,580)
072 - CSA #41 Gabilan Acres/Boronda	16,961	62,334	13,900	59,670	59,670	(2,664)
073 - CSA #44 Corral De Tierra Oaks 1/2/3	4,058	23,259	13,076	42,119	42,119	18,860
074 - CSA #45 Oak Hills	23,794	121,293	26,727	85,360	85,360	(35,933)
075 - CSA #45-Oak Hills - Open Space	67,483	44,963	21,734	23,454	23,454	(21,509)
076 - CSA #47 Carmel Views/Mar Vista	117,868	34,632	20,019	37,630	37,630	2,998
077 - CSA #50 Rioway Tract No. 2	123,482	1,093,571	90,335	1,303,180	1,303,180	209,609
078 - CSA #51 High Meadow	7,990	63,756	9,116	85,513	85,513	21,757
079 - CSA #52 Carmel Valley Village	1,272	70,415	3,654	94,487	94,487	24,072
080 - CSA #53 Arroyo Seco	123,087	13,166	5,220	25,956	25,956	12,790
081 - CSA #54 Manzanita/Sarsi Subdivisions	1,028	11,898	3,599	10,306	10,306	(1,592)
082 - CSA #55 Robles Del Rio	803	67,205	3,694	84,031	84,031	16,826
083 - CSA #56 Del Mesa Carmel	1,356	56,829	3,609	56,723	56,723	(106)
084 - CSA #57 Los Tulares Subdivision	480	9,524	2,384	9,466	9,466	(58)
085 - CSA #58 Vista Dorado	2,161	18,025	3,670	15,837	15,837	(2,188)
086 - CSA #62 Rancho Del Monte 14	973	63,622	2,464	66,639	66,639	3,017
087 - CSA #66 Oak Tree Views	28,617	43,708	17,168	51,003	51,003	7,295
088 - CSA #67 Corral De Tierra Oaks 4	5,562	689,788	14,002	715,066	715,066	25,278
089 - CSA #68 Vierra Canyon Knolls	691	19,833	1,333	21,146	21,146	1,313
090 - CSA #69 Ralph Lane	-	288	288	288	288	-
091 - CSA #72 Las Palmas Ranch	25,060	41,816	33,237	80,955	80,955	39,139
092 - CSA #74 Ambulance	1,761,742	2,198,103	2,119,072	2,337,495	2,337,495	139,392
093 - CSA #75 Chualar Consolidated	189,114	220,500	198,170	274,485	274,485	53,985
151 - Pajaro Co Sanitation District	1,509,677	912,574	2,099,509	2,933,571	2,933,571	2,020,997
156 - Boronda Co Sanitation Dist	149,841	205,602	196,169	166,662	166,662	(38,940)
157 - San Jerardo CSD	129,015	341,548	380,978	190,165	190,165	(151,383)
175 - Castroville-Pajaro Housing Successor	160,368	809,943	566,000	355,000	355,000	(454,943)
177 - Fort Ord Housing Successor	-	1,811	1,811	-	-	(1,811)
178 - East Garrison Housing Successor	-	94	94	-	-	(94)

Schedules

Source Classification	Actual	Adopted Budget	Current Year Estimate	Requested Budget	Recommended Budget	Recommended Change From
	2021-22	2022-23	2022-23	2023-24	2023-24	Adopted
180 - East Garrison Community Facility District	18,892	43,925	38,925	36,125	36,125	(7,800)
181 - East Garrison Community Services District	1,815,598	2,010,257	2,035,762	1,997,520	1,997,520	(12,737)
182 - East Garrison Developer Reimbursements	11,940	129,000	512,000	135,000	135,000	6,000
251 - Public Improvement Corp Debt Service	15,990,350	15,978,525	15,978,525	15,480,525	15,480,525	(498,000)
306 - Boronda Co San Revenue Bonds	38,850	38,250	38,250	38,600	38,600	350
312 - Chualar Co Water Ser A	15,699	15,849	15,849	15,924	15,924	75
402 - Capital Projects Fund	4,105,694	-	-	-	-	-
404 - Capital Projects	16,268,083	74,052,709	55,573,533	129,373,205	47,782,084	(26,270,625)
405 - NGEN Radio Project	-	1,536,000	1,536,000	-	-	(1,536,000)
451 - Natividad Medical Center	430,861,572	366,221,605	382,527,072	399,347,035	399,347,035	33,125,430
452 - Parks Lake & Resort Operations	3,362,834	4,193,603	3,698,724	3,686,682	3,686,682	(506,921)
453 - Laguna Seca Recreational Area	21,769,139	18,560,643	17,735,369	27,293,894	27,293,894	8,733,251
475 - General Liability Fund	15,009,286	21,666,611	20,999,051	22,465,788	22,465,788	799,177
476 - Worker's Comp Fund	29,134,092	26,185,000	24,329,875	26,500,000	26,500,000	315,000
477 - Benefit Programs Fund	12,820,956	14,487,437	13,010,702	14,430,831	14,430,831	(56,606)
478 - Resource Planning	(9,990,201)	10,870,803	15,507,668	3,515,027	4,465,027	(6,405,776)
Grand Total	\$ 1,650,167,746	\$ 1,854,555,760	\$ 1,787,752,359	\$ 1,980,670,469	\$ 1,886,640,297	\$ 32,084,537

County of Monterey
Analysis of Expenditures by Object and Subobject
All Funds
Fiscal Year 2023-24

Source Classification	Actual 2021-22	Adopted Budget 2022-23	Current Year Estimate 2022-23	Requested Budget 2023-24	Recommended Budget 2023-24	Recommended Change From Adopted
COUNTY						
Salaries and Employee Benefits						
6111BL - Bilingual Pay	-	17,712	-	18,360	18,360	648
6111PD - Pay Differential	-	1,331,572	-	2,756,424	2,756,424	1,424,852
6111 - Regular Employees	466,298,022	547,215,612	500,554,126	593,356,642	589,920,655	42,705,043
6111SP - Standby Pay	-	1,060,511	37,848	1,283,256	1,283,256	222,745
6111SS - Salary Savings	-	(30,086,752)	(282,000)	(39,302,959)	(40,252,088)	(10,165,336)
6111VB - Vacation Buy Back	-	3,494,784	271,559	3,491,805	3,389,701	(105,083)
6111XX - Forecasted Supplemental Pays	-	7,855,213	55,048	10,061,652	10,061,652	2,206,439
6112 - Temporary Employees	10,580,047	10,386,908	4,018,526	4,966,735	4,966,735	(5,420,173)
6113 - Overtime	17,488,700	10,554,676	14,008,406	8,407,361	8,407,361	(2,147,315)
6121 - PERS	99,435,110	122,027,620	127,981,306	131,886,804	131,215,106	9,187,486
6121PS - PERS	-	15,402,537	891,642	-	-	(15,402,537)
6122 - Other Post-Employment Benefits	9,296,013	9,790,415	9,816,710	9,343,506	9,343,506	(446,909)
6125 - Supplemental Unfunded Accrued Liability	-	-	-	15,227,707	15,227,707	15,227,707
6131 - FICA	24,780,115	28,859,705	27,056,712	31,748,521	31,596,289	2,736,584
6132 - Medicare	7,184,316	8,009,535	6,601,369	8,771,002	8,729,855	720,320
6141 - Flex Co Paid Insurance-Pretax	10,072,251	10,652,169	9,352,586	11,096,676	11,037,510	385,341
6142 - Life Insurance	336,370	420,645	325,489	433,719	431,103	10,458
6143 - Long-Term Disability Insurance	364,568	236,640	398,880	249,348	247,260	10,620
6144 - Short-Term Disability Insurance	399,558	276,024	504,692	290,520	288,084	12,060
6145 - Dental Insurance	2,508,483	3,414,561	2,894,944	2,527,320	2,512,716	(901,845)
6146 - Medical Insurance	15,103	-	-	-	-	-
6147 - Vision Insurance	826,247	970,635	792,187	798,516	793,896	(176,739)
6148 - Unemployment Insurance	466,487	607,961	486,078	557,546	557,546	(50,415)
6161 - Workers Compensation Insurance	23,451,573	25,538,452	25,522,377	25,845,603	25,845,603	307,151
6171 - Employee Assistance Program	109,901	131,310	126,209	-	-	(131,310)
6172 - Educational Assistance Program	18,520	-	-	-	-	-
6173 - Flex-Benefit Plan Contribution	83,115,152	109,947,966	93,846,822	115,114,074	114,437,082	4,489,116
6174NF - Special Benefits Not Forecasted	-	61,400	-	207,676	207,676	146,276
6174 - Special Benefits	2,409,394	1,177,939	1,276,839	1,263,706	1,253,987	76,048
6175 - Wellness Plan	142,481	167,871	168,604	228,032	228,032	60,161
Total Salaries and Employee Benefits	\$ 759,298,408	\$ 889,523,621	\$ 826,706,959	\$ 940,629,552	\$ 934,505,014	\$ 44,981,393
Services and Supplies						
6211 - Agricultural Service & Supply	194,856	204,815	341,250	303,875	303,875	99,060
6221 - Clothing and Personal Supplies	664,071	514,029	548,714	745,220	745,220	231,191
6222 - Uniforms and Safety Equipment	549,008	1,641,709	1,558,618	2,077,140	2,077,140	435,431
6231 - Communication Charges - External	2,470,301	1,842,915	1,929,944	2,397,914	2,397,914	554,999
6232 - Communication Charges - Internal	126,881	86,387	81,387	75,387	75,387	(11,000)
6241 - Food	4,023,954	3,715,265	3,185,975	3,380,278	3,380,278	(334,987)
6251 - Cleaning and Janitorial	4,305,784	3,991,555	4,012,172	4,126,970	3,051,970	(939,585)
6252 - Household Expenses	591,794	147,416	145,173	179,622	179,622	32,206
6261 - Insurance - General Liability (Non-recoverable)	9,876,048	7,957,437	7,890,043	7,399,761	7,399,761	(557,676)
6262 - Insurance - General Liability (Recoverable)	9,021,856	10,105,981	9,982,873	10,987,197	10,987,197	881,216
6263 - Insurance - Loss Contingency	-	180,280	184,000	270,700	270,700	90,420
6264 - Insurance - Malpractice	1,876,977	1,795,839	1,925,599	1,793,750	1,793,750	(2,089)
6266 - Insurance - Property	3,789,925	5,092,115	4,417,746	5,117,905	5,117,905	25,790
6267 - Insurance - Stop Loss	8,270,517	10,214,075	9,256,600	12,654,575	12,654,575	2,440,500
6268 - Insurance - Other	1,227,114	1,091,047	1,081,838	1,737,448	1,737,448	646,401
6301 - Grand Jury Related Expense	35,531	45,000	45,000	49,283	49,283	4,283
6302 - Trial Related Expense	822,976	1,068,600	984,519	938,276	938,276	(130,324)
6311 - Buildings & Improvements Maintenance - External	10,600,537	10,681,756	10,288,934	7,970,499	7,970,499	(2,711,257)
6312 - Buildings & Improvements Maintenance - Internal	583,899	90,722	87,500	1,741,183	1,741,183	1,650,461
6321 - Equipment Maintenance	3,590,132	12,914,253	10,257,405	11,396,398	11,396,398	(1,517,855)
6331 - Dental Supplies	-	65	-	-	-	(65)
6332 - Laboratory Supplies	3,342,611	5,038,168	5,068,912	5,480,531	5,480,531	442,363
6333 - Medical Supplies	33,271,031	20,574,695	32,499,632	24,202,070	24,202,070	3,627,375
6351 - Membership Fees	1,632,637	1,914,026	2,130,691	1,963,841	1,928,341	14,315
6361 - Noncapital Equipment	1,376,386	890,813	1,375,912	757,412	757,412	(133,401)
6381 - Advertising	1,056,350	1,546,544	1,233,720	2,291,187	2,216,187	669,643
6382 - Audio-Visual Service & Supply	180,491	145,050	140,277	371,135	371,135	226,085
6383 - Miscellaneous Services	2,496,975	1,351,965	1,608,814	2,297,071	2,195,071	843,106

Schedules

Source Classification	Actual 2021-22	Adopted Budget 2022-23	Current Year Estimate 2022-23	Requested Budget 2023-24	Recommended Budget 2023-24	Recommended Change From Adopted
6384 - Miscellaneous Supplies	1,268,088	2,367,505	1,606,729	1,438,064	1,438,064	(929,441)
6401 - Books/Periodicals and Other Subscriptions	1,427,011	924,160	814,814	855,034	855,034	(69,126)
6402 - Bottled Water	72,899	85,498	62,978	53,792	53,792	(31,706)
6403 - Office Machine Supply	10,278	5,670	8,085	6,200	6,200	530
6404 - Courier Services - External	160,999	43,692	44,006	42,671	42,671	(1,021)
6405 - Courier Services - Internal	450,239	625,109	489,105	495,824	495,824	(129,285)
6406 - Mail Handling Charges	214,515	387,190	246,989	332,511	332,511	(54,679)
6407 - Minor Computer Hardware	2,086,939	2,078,278	1,865,190	2,367,435	2,359,435	281,157
6408 - Minor Computer Software	15,130,667	10,111,460	10,255,540	11,805,765	11,714,810	1,603,350
6409 - Minor Equipment and Furnishings	3,649,308	2,052,182	2,332,361	2,389,340	2,389,340	337,158
6410 - Office Supplies	1,379,969	1,871,542	1,952,210	1,898,423	1,896,423	24,881
6411 - Postage and Shipping	1,429,686	1,092,834	1,229,505	1,558,380	1,558,380	465,546
6412 - Printing, Graphics and Binding Charge - External	2,747,903	1,852,968	2,149,314	2,598,674	2,496,475	643,507
6413 - Printing, Graphics and Binding Charge - Internal	1,014	500	321	250	250	(250)
6414 - Other Office Expense	75,693	71,591	46,105	63,151	63,151	(8,440)
6415 - Records Retention Charges	808,012	679,216	927,352	951,517	951,517	272,301
6601 - Accounting & Auditing Charges	494,667	790,967	788,886	688,518	688,518	(102,449)
6602 - Data Processing Services - External	2,657,676	2,872,084	2,588,272	2,704,582	2,704,582	(167,502)
6603 - Data Processing Services - Internal	11,338,394	11,869,045	11,979,781	11,650,776	11,649,388	(219,657)
6604 - Hospital Charges	6,664,346	8,161,617	7,502,828	7,530,680	7,530,680	(630,937)
6605 - Laboratory Services	3,103,391	1,110,134	892,466	1,075,850	1,075,850	(34,284)
6606 - Legal Service - External	3,079,807	4,464,858	4,481,703	4,141,486	4,141,486	(323,372)
6607 - Legal Service - Internal	2,433,122	2,176,000	2,092,413	2,311,299	2,311,299	135,299
6608 - Other Medical Services	82,468,651	92,501,090	97,744,772	97,455,113	97,215,113	4,714,023
6609 - Other Personnel Services	26,544,788	23,605,710	24,960,609	28,712,730	28,682,730	5,077,020
6610 - Outpatient Services	12,265,032	12,668,232	14,562,328	17,465,947	17,465,947	4,797,715
6611 - Staff Training Services	1,101,994	1,160,043	1,097,038	1,175,963	1,175,963	15,920
6612 - Temporary Help Services	2,771,163	5,674,578	27,703,526	12,650,516	12,650,516	6,975,938
6613 - Other Professional & Special Services	91,468,676	76,242,217	72,855,660	75,698,158	71,743,746	(4,498,471)
6614 - Contribution and Grants for Non-Governmental Agencies	5,131,486	6,201,129	3,814,743	3,692,000	3,692,000	(2,509,129)
6801 - Publications and Legal Notices	158,452	140,237	133,303	130,085	130,085	(10,152)
6811 - Rents and Leases - Buildings	8,714,313	7,090,636	2,344,483	2,575,697	2,575,697	(4,514,939)
6821 - Rents and Leases - Equipment	4,848,493	5,632,761	5,542,836	6,374,206	6,374,206	741,445
6831 - Criminal Justice System	415,567	482,500	475,000	482,500	482,500	-
6832 - Elections	183,480	142,300	146,206	150,000	150,000	7,700
6833 - Purchases For Resale	13,856	20,000	47,455	20,000	20,000	-
6834 - Social Services	56,585,040	24,910,253	34,388,763	28,243,841	28,243,841	3,333,588
6835 - Other Special Departmental Expenses	8,171,784	11,432,680	8,192,142	11,857,251	11,729,251	296,571
6861 - Conference/Lodging/Meals/Travel	1,207,167	1,527,320	1,446,606	2,023,868	2,011,868	484,548
6862 - Employee Mileage Reimbursement	80,695	131,336	130,572	255,751	255,751	124,415
6863 - Employee Moving Expense	107,750	10,000	10,000	10,000	10,000	-
6864 - Fleet Service Charge	5,870,753	5,573,152	5,608,234	6,515,201	6,515,201	942,049
6865 - Nonemployee Transportation & Travel	209,647	74,559	92,430	79,918	79,918	5,359
6866 - Vehicle Maintenance - External	4,186,997	3,332,655	3,836,610	4,469,920	4,469,920	1,137,265
6867 - Vehicle Usage/Replacement	4,265,359	3,707,195	4,468,813	5,389,169	4,060,169	352,974
6881 - Utilities	13,681,740	13,084,276	15,085,264	17,175,435	16,945,471	3,861,195
Total Services and Supplies	\$ 497,116,149	\$ 455,881,481	\$ 491,307,594	\$ 492,270,119	\$ 484,854,701	\$ 28,973,220
Other Charges						
7011 - Out of Home Care	21,078,149	24,167,939	26,201,298	25,876,006	25,876,006	1,708,067
7012 - Public Assistance Payments	43,894,348	47,325,814	48,926,788	54,556,417	54,556,417	7,230,603
7013 - Reimbursement to Other Governmental Age	4,494,617	7,115,424	3,590,417	5,565,403	5,565,403	(1,550,021)
7014 - Other Support and Care	8,123,575	9,373,238	9,946,652	10,872,148	10,730,028	1,356,790
7041 - Bond Principal Payments	9,512,611	13,609,742	10,611,912	13,600,850	13,600,850	(8,892)
7051 - Other Debt Retirement	671,032	1,232,694	907,878	1,046,083	1,046,083	(186,611)
7061 - Interest On Bonds	6,470,289	6,807,974	6,523,891	6,095,481	6,095,481	(712,493)
7071 - Interest On Other Long-Term Debt	1,529,574	770,085	1,372,058	1,235,903	1,235,903	465,818
7082 - Other Interest	9,549	7,599	7,599	5,024	5,024	(2,575)
7091 - Claims, Judgments & Damages	34,752,188	35,523,110	33,895,497	34,189,573	34,189,573	(1,333,537)
7092 - Insurance Deductible	202,778	130,000	130,000	100,000	100,000	(30,000)
7121 - Taxes and Assessments	245,300	157,222	283,800	686,871	686,871	529,649
7141 - Depreciation - Buildings	-	1,140,099	982,616	1,103,283	1,103,283	(36,816)
7201 - Contribution to Other Agencies	77,274,091	15,928,949	15,128,727	16,638,950	16,638,950	710,001
7301 - Cost Plan Charges	(2,557,162)	(487,930)	(551,358)	(2,070,246)	(2,070,246)	(1,582,316)
7302 - Expenditure Transfers	266,857	1,364,421	1,349,421	2,068,335	2,068,335	703,914
7304 - Interfund Reimbursement	(28,664,826)	(30,809,742)	(27,852,381)	(32,548,508)	(32,548,508)	(1,738,766)
7305 - Intrafund Reimbursement	(21,970,977)	(20,647,636)	(19,657,978)	(23,869,192)	(23,869,192)	(3,221,556)
Total Other Charges	\$ 155,331,993	\$ 112,709,002	\$ 111,796,837	\$ 115,152,381	\$ 115,010,261	\$ 2,301,259
Capital Assets						
7510 - Right-To-Use Expenditure - Land	16,740	-	-	-	-	-

Source Classification	Actual 2021-22	Adopted Budget 2022-23	Current Year Estimate 2022-23	Requested Budget 2023-24	Recommended Budget 2023-24	Recommended Change From Adopted
7521 - Buildings and Improvements	11,906,524	7,956,606	5,288,947	6,853,802	6,653,802	(1,302,804)
7522 - Right-To-Use Expenditure - Buildings	2,846,172	-	5,039,335	4,792,267	4,792,267	4,792,267
7531 - Equipment	6,914,144	10,591,599	9,246,524	10,139,865	10,139,865	(451,734)
7532 - Vehicles	3,215,602	4,707,638	5,806,041	5,566,814	5,346,814	639,176
7533 - Right-To-Use Expenditure - Equipment	591,000	-	338,641	610,733	610,733	610,733
7541 - Infrastructure	4	-	-	-	-	-
7551 - Construction In Progress	14,284,565	94,268,697	81,986,778	150,591,183	68,225,087	(26,043,610)
7561 - Capital Leases	-	81,600	81,600	81,600	81,600	-
7562 - Intangible Assets	746,787	801,269	2,673,856	738,850	738,850	(62,419)
Total Capital Assets	\$ 40,521,537	\$ 118,407,409	\$ 110,461,722	\$ 179,375,114	\$ 96,589,018	\$ (21,818,391)
Other Financing Uses						
7612 - Disbursement of Loans	-	2,730,338	2,428,931	6,050,834	6,050,834	3,320,496
7614 - Operating Transfers Out	197,802,123	267,404,187	244,007,656	239,022,523	241,460,523	(25,943,664)
Total Other Financing Uses	\$ 197,802,123	\$ 270,134,525	\$ 246,436,587	\$ 245,073,357	\$ 247,511,357	\$ (22,623,168)
Appropriation for Contingencies						
7811 - Contingencies	97,536	7,899,722	1,042,660	8,169,946	8,169,946	270,224
Total Appropriation for Contingencies	\$ 97,536	\$ 7,899,722	\$ 1,042,660	\$ 8,169,946	\$ 8,169,946	\$ 270,224
Grand Total	\$ 1,650,167,746	\$ 1,854,555,760	\$ 1,787,752,359	\$ 1,980,670,469	\$ 1,886,640,297	\$ 32,084,537

**County of Monterey
Overtime
Fiscal Year 2023-24**

Source Classification	Actual 2021-22	Adopted Budget 2022-23	Current Year Estimate 2022-23	Requested Budget 2023-24	Recommended Budget 2023-24	Recommended Change From Adopted
Summarization by Department						
Agricultural Commissioner	21,609	25,000	21,443	20,000	20,000	(5,000)
Assessor-County Clerk-Recorder	2,052	500	866	100	100	(400)
Auditor-Controller	12,148	-	3,917	-	-	-
Child Support Services	1,357	10,000	10,000	2,000	2,000	(8,000)
Clerk of the Board	16	-	-	-	-	-
County Administrative Office	18,260	500	593	500	500	-
County Counsel	688	-	1,069	1,500	1,500	1,500
District Attorney	66,840	66,969	72,756	61,713	61,713	(5,256)
Elections	18,735	15,000	15,000	15,000	15,000	-
Emergency Communications	602,219	740,646	736,995	962,022	962,022	221,376
Health	702,830	700,843	569,721	730,416	730,416	29,573
Housing and Community Development	23,383	19,556	33,807	39,057	39,057	19,501
Human Resources	7,779	-	-	-	-	-
Information Technology	37,573	45,000	45,000	45,000	45,000	-
Natividad Medical Center	11,594,955	-	-	-	-	-
Probation	235,026	358,789	358,789	358,789	358,789	-
Public Defender	14,688	18,500	18,500	18,500	18,500	-
Public Works, Facilities & Parks	108,574	153,193	138,215	154,878	154,878	1,685
Sheriff-Coroner	2,995,690	6,998,180	10,580,069	4,595,886	4,595,886	(2,402,294)
Social Services	1,023,590	1,402,000	1,401,666	1,402,000	1,402,000	-
Treasurer-Tax Collector	688	-	-	-	-	-
Grand Total	\$ 17,488,700	\$ 10,554,676	\$ 14,008,406	\$ 8,407,361	\$ 8,407,361	\$ (2,147,315)

Countywide Position Summary

Adopted FY 2022-23 to Recommended FY 2023-24 Positions

Classification Code	Classification Label	Adopted Budget 2021-2022	Adopted Budget 2022-2023	Recommended Budget 2023-2024	Change
Board of Supervisors					
10A01	BOARD OF SUPERVISORS CHAIRMAN	1.00	1.00	1.00	0.00
10A02	BOARD OF SUPERVISORS MEMBER	4.00	4.00	4.00	0.00
14H02	BOARD OF SUPERVISORS POLICY ANALYST	5.00	5.00	10.00	5.00
14H10	BOARD OF SUPERVISORS CHIEF OF STAFF	5.00	5.00	5.00	0.00
80A90	BOARD OF SUPERVISORS EXECUTIVE ASSISTANT	5.00	5.00	0.00	(5.00)
Total Board of Supervisors		20.00	20.00	20.00	0.00
Department of Emergency Management					
11A13	DIRECTOR OF EMERGENCY MANAGEMENT	0.00	0.00	1.00	1.00
14A25	EMERGENCY SERVICES MANAGER	0.00	0.00	1.00	1.00
14C30	MANAGEMENT ANALYST II	0.00	0.00	1.00	1.00
20B95	FINANCE MANAGER I	0.00	0.00	1.00	1.00
41G01	EMERGENCY SERVICES PLANNER	0.00	0.00	4.00	4.00
80A33	ADMINISTRATIVE SECRETARY	0.00	0.00	1.00	1.00
Total Department of Emergency Management		0.00	0.00	9.00	9.00
County Administrative Office					
11A01	ADMINISTRATIVE OFFICER	1.00	1.00	1.00	0.00
12E01	CHIEF ASSISTANT COUNTY ADMINISTRATIVE OFFICER	0.00	0.00	1.00	1.00
12E03	ASSISTANT COUNTY ADMINISTRATIVE OFFICER	2.00	2.00	1.00	(1.00)
12E16	WIB EXECUTIVE DIRECTOR	1.00	1.00	1.00	0.00
14A23	PRINCIPAL ADMINISTRATIVE ANALYST	5.00	5.00	6.00	1.00
14A24	COUNTY BUDGET DIRECTOR	1.00	1.00	1.00	0.00
14A25	EMERGENCY SERVICES MANAGER	1.00	1.00	0.00	(1.00)
14A28	COUNTY COMMUNICATIONS DIRECTOR	1.00	1.00	1.00	0.00
14C30	MANAGEMENT ANALYST II	5.00	7.00	6.00	(1.00)
14C31	MANAGEMENT ANALYST III	10.00	9.00	10.00	1.00
14C37	COUNTY MEDIA ANALYST	1.00	1.00	1.00	0.00
14E20	BUYER II	2.00	2.00	3.00	1.00
14G02	MANAGEMENT ANALYST I	5.00	2.00	2.00	0.00
14H64	FLEET MANAGER	1.00	0.00	0.00	0.00
14M05	CANNABIS PROGRAM MANAGER	0.00	0.00	1.00	1.00
14M12	ECONOMIC DEVELOPMENT MANAGER	1.00	1.00	1.00	0.00
14M25	COUNTY HOMELESS SERVICES DIRECTOR	0.00	1.00	1.00	0.00
14N05	ADMINISTRATIVE OPERATIONS MANAGER	1.00	0.00	0.00	0.00
14N35	CONTRACTS & PURCHASING OFFICER	1.00	1.00	1.00	0.00
20B10	ACCOUNTANT I	2.00	2.00	0.00	(2.00)
20B11	ACCOUNTANT II	2.00	1.00	2.00	1.00
20B12	ACCOUNTANT III	0.00	0.00	1.00	1.00
20B93	FINANCE MANAGER II	2.00	2.00	2.00	0.00
41G01	EMERGENCY SERVICES PLANNER	4.00	4.00	0.00	(4.00)
43C11	PERMIT TECHNICIAN II	1.00	1.00	1.00	0.00
43J09	SENIOR DEPARTMENTAL INFORMATION SYSTEMS COORDINATOR	1.00	1.00	1.00	0.00
43L18	COMMUNICATIONS TECHNICIAN III	1.00	0.00	0.00	0.00
43L20	COMMUNICATIONS TECHNICIAN I	1.00	0.00	0.00	0.00

Adopted FY 2022-23 to Recommended FY 2023-24 Positions

Classification Code	Classification Label	Adopted Budget 2021-2022	Adopted Budget 2022-2023	Recommended Budget 2023-2024	Change
60G21	WIB EMPLOYMENT PROGRAMS REPRESENTATIVE II	3.00	3.00	3.00	0.00
60G33	WIB EMPLOYMENT PROGRAMS REPRESENTATIVE III	1.00	1.00	1.00	0.00
60I02	PROGRAM MANAGER II	1.00	1.00	0.00	(1.00)
68A30	RANGE MASTER	1.00	0.00	0.00	0.00
68C02	RANGE AIDE	1.00	0.00	0.00	0.00
70F21	COURIER	4.00	0.00	0.00	0.00
70F23	STOREKEEPER	1.00	0.00	0.00	0.00
70F79	WAREHOUSE WORKER	5.00	1.00	0.00	(1.00)
70F80	SENIOR STOREKEEPER	1.00	0.00	1.00	1.00
70F82	SUPERVISING WAREHOUSE WORKER	1.00	0.00	0.00	0.00
72C20	MECHANIC I	2.00	0.00	0.00	0.00
72C23	MECHANIC II	11.00	0.00	0.00	0.00
72C26	MECHANIC III	2.00	0.00	0.00	0.00
72C83	FLEET SERVICE WRITER	1.00	0.00	0.00	0.00
80A32	SENIOR SECRETARY	3.00	5.00	4.00	(1.00)
80A97	EXECUTIVE ASSISTANT TO ADMINISTRATIVE OFFICER	1.00	1.00	1.00	0.00
80A99	ADMINISTRATIVE SECRETARY-CONFIDENTIAL	2.00	2.00	2.00	0.00
80E01	OFFICE ASSISTANT I	1.00	0.00	0.00	0.00
80G21	DATA ENTRY OPERATOR II	1.00	0.00	0.00	0.00
80J22	SENIOR ACCOUNT CLERK	2.00	1.00	1.00	0.00
80J30	ACCOUNTING TECHNICIAN	2.00	1.00	1.00	0.00
80O22	MAILROOM CLERK	1.50	0.00	0.00	0.00
80O23	SENIOR MAILROOM CLERK	1.00	0.00	0.00	0.00
99ZXX	ALLOCATION ON LOAN XX	17.00	17.00	17.00	0.00
Total County Administrative Office		119.50	80.00	76.00	(4.00)
Human Resources					
11A07	DIRECTOR OF HUMAN RESOURCES	1.00	1.00	1.00	0.00
12C37	ASSISTANT DIRECTOR OF HUMAN RESOURCES	1.00	2.00	2.00	0.00
14B21	ASSOCIATE PERSONNEL ANALYST	13.00	13.00	12.00	(1.00)
14B28	SUPERVISING PERSONNEL ANALYST	1.00	1.00	1.00	0.00
14B32	SENIOR PERSONNEL ANALYST	5.00	5.00	5.00	0.00
14B60	RISK & BENEFITS SPECIALIST-CONFIDENTIAL	1.00	1.00	1.00	0.00
14B62	ASSOCIATE RISK & BENEFITS ANALYST	2.00	2.00	2.00	0.00
14B63	SENIOR RISK & BENEFITS ANALYST	1.00	1.00	2.00	1.00
14C30	MANAGEMENT ANALYST II	1.00	1.00	2.00	1.00
14C31	MANAGEMENT ANALYST III	3.00	3.00	2.00	(1.00)
14G02	MANAGEMENT ANALYST I	0.00	1.00	1.00	0.00
14H03	PERSONNEL TECHNICIAN-CONFIDENTIAL	5.00	5.00	4.00	(1.00)
14M61	HR PROGRAM MANAGER	4.00	3.00	5.00	2.00
20B93	FINANCE MANAGER II	1.00	1.00	1.00	0.00
80A99	ADMINISTRATIVE SECRETARY-CONFIDENTIAL	1.00	0.00	0.00	0.00
80J30	ACCOUNTING TECHNICIAN	1.00	1.00	1.00	0.00
Total Human Resources		41.00	41.00	42.00	1.00
Civil Rights Office					
14B25	EQUAL OPPORTUNITY OFFICER	1.00	1.00	1.00	0.00
14B47	ASSOCIATE EQUAL OPPORTUNITY ANALYST	2.00	1.00	1.00	0.00
14B49	SENIOR EQUAL OPPORTUNITY ANALYST	1.00	2.00	2.00	0.00
80A99	ADMINISTRATIVE SECRETARY-CONFIDENTIAL	1.00	1.00	1.00	0.00
Total Civil Rights Office		5.00	5.00	5.00	0.00

Adopted FY 2022-23 to Recommended FY 2023-24 Positions

Classification Code	Classification Label	Adopted Budget 2021-2022	Adopted Budget 2022-2023	Recommended Budget 2023-2024	Change
Auditor-Controller					
10B02	AUDITOR-CONTROLLER	1.00	1.00	1.00	0.00
12A02	ASSISTANT AUDITOR-CONTROLLER	1.00	1.00	1.00	0.00
14B32	SENIOR PERSONNEL ANALYST	0.00	0.00	0.50	0.50
14C71	ADMINISTRATIVE SERVICES OFFICER	1.00	1.00	1.00	0.00
14P32	ERP BUSINESS ANALYST	5.00	5.00	8.00	3.00
16F41	DEPARTMENTAL INFORMATION SYSTEMS MANAGER II	0.00	1.00	1.00	0.00
20B21	ACCOUNTANT AUDITOR II	1.00	1.00	2.00	1.00
20B22	ACCOUNTANT AUDITOR III	6.00	7.00	9.00	2.00
20B24	AUDITOR-CONTROLLER ANALYST I	6.00	6.00	8.00	2.00
20B25	AUDITOR-CONTROLLER ANALYST II	2.00	2.00	5.00	3.00
20B31	INTERNAL AUDITOR II	1.00	1.00	1.00	0.00
20B97	CHIEF DEPUTY AUDITOR-CONTROLLER	3.00	3.00	4.00	1.00
80J21	ACCOUNT CLERK	1.00	1.00	1.00	0.00
80J22	SENIOR ACCOUNT CLERK	3.00	0.00	0.00	0.00
80J30	ACCOUNTING TECHNICIAN	2.00	5.00	5.00	0.00
80J80	ACCOUNTS PAYABLE SUPERVISOR	1.00	0.00	0.00	0.00
80J96	PAYROLL TECHNICIAN-CONFIDENTIAL	6.00	6.00	6.00	0.00
80J97	SENIOR PAYROLL TECHNICIAN - CONFIDENTIAL	2.00	2.00	2.00	0.00
80J98	SUPERVISING PAYROLL COORDINATOR-CONFIDENTIAL	1.00	1.00	1.00	0.00
Total Auditor-Controller		43.00	44.00	56.50	12.50
Treasurer-Tax Collector					
10B06	TREASURER-TAX COLLECTOR	1.00	1.00	1.00	0.00
12A24	ASSISTANT TREASURER-TAX COLLECTOR	1.00	1.00	1.00	0.00
14C31	MANAGEMENT ANALYST III	3.00	3.00	3.00	0.00
14C45	TREASURY MANAGER	1.00	0.00	0.00	0.00
14C47	CHIEF DEPUTY TREASURER-TAX COLLECTOR	2.00	3.00	3.00	0.00
14C70	ADMINISTRATIVE SERVICES ASSISTANT	1.00	1.00	1.00	0.00
14C71	ADMINISTRATIVE SERVICES OFFICER	1.00	1.00	1.00	0.00
16C88	BUSINESS TECHNOLOGY ANALYST III	1.00	1.00	1.00	0.00
20B10	ACCOUNTANT I	1.00	1.00	1.00	0.00
20B11	ACCOUNTANT II	2.00	2.00	2.00	0.00
20B12	ACCOUNTANT III	2.00	2.00	2.00	0.00
20B41	TREASURY OFFICER II	3.00	3.00	3.00	0.00
20B93	FINANCE MANAGER II	1.00	1.00	1.00	0.00
20B95	FINANCE MANAGER I	1.00	1.00	1.00	0.00
20B96	FINANCE SYSTEMS MANAGER	1.00	1.00	1.00	0.00
25A32	REVENUE OFFICER II	9.00	9.00	9.00	0.00
25A33	SUPERVISING REVENUE OFFICER	1.00	1.00	1.00	0.00
80J21	ACCOUNT CLERK	9.00	9.00	9.00	0.00
80J22	SENIOR ACCOUNT CLERK	1.00	1.00	1.00	0.00
80J30	ACCOUNTING TECHNICIAN	7.00	7.00	7.00	0.00
Total Treasurer-Tax Collector		49.00	49.00	49.00	0.00
Assessor-County Clerk-Recorder					
11B01	ASSESSOR-COUNTY CLERK-RECORDER	1.00	1.00	1.00	0.00
12A05	ASSISTANT COUNTY CLERK-RECORDER	1.00	1.00	1.00	0.00
12A15	ASSISTANT ASSESSOR-VALUATION	1.00	1.00	1.00	0.00
14B32	SENIOR PERSONNEL ANALYST	1.00	1.00	1.00	0.00
14C71	ADMINISTRATIVE SERVICES OFFICER	1.00	1.00	1.00	0.00

Adopted FY 2022-23 to Recommended FY 2023-24 Positions

Classification Code	Classification Label	Adopted Budget 2021-2022	Adopted Budget 2022-2023	Recommended Budget 2023-2024	Change
14G02	MANAGEMENT ANALYST I	1.00	1.00	1.00	0.00
14H03	PERSONNEL TECHNICIAN-CONFIDENTIAL	1.00	1.00	1.00	0.00
14K45	AUDITOR APPRAISER MANAGER	1.00	1.00	1.00	0.00
16C87	BUSINESS TECHNOLOGY ANALYST II	1.00	1.00	1.00	0.00
16F40	DEPARTMENTAL INFORMATION SYSTEMS MANAGER I	1.00	1.00	1.00	0.00
16F41	DEPARTMENTAL INFORMATION SYSTEMS MANAGER II	1.00	1.00	1.00	0.00
20B10	ACCOUNTANT I	1.00	1.00	1.00	0.00
20B95	FINANCE MANAGER I	1.00	1.00	1.00	0.00
28A21	APPRAISER II	13.00	13.00	13.00	0.00
28A22	APPRAISER III	5.00	5.00	5.00	0.00
28A80	SUPERVISING APPRAISER	2.00	2.00	2.00	0.00
28B21	AUDITOR-APPRAISER II	4.00	4.00	4.00	0.00
28B22	AUDITOR-APPRAISER III	1.00	1.00	1.00	0.00
43F21	MAP DRAFTING TECHNICIAN	1.00	1.00	0.00	(1.00)
43F80	SENIOR MAP DRAFTING TECHNICIAN	1.00	1.00	1.00	0.00
80A99	ADMINISTRATIVE SECRETARY-CONFIDENTIAL	1.00	1.00	1.00	0.00
80E21	OFFICE ASSISTANT II	7.00	7.00	7.00	0.00
80E22	OFFICE ASSISTANT III	6.00	6.00	5.00	(1.00)
80E80	PRINCIPAL OFFICE ASSISTANT	1.00	1.00	1.00	0.00
80E81	SUPERVISING OFFICE ASSISTANT I	2.00	2.00	2.00	0.00
80E82	SUPERVISING OFFICE ASSISTANT II	1.00	1.00	1.00	0.00
80E92	RECORDER SERVICES SUPERVISOR	1.00	1.00	1.00	0.00
80J22	SENIOR ACCOUNT CLERK	1.00	1.00	1.00	0.00
80J30	ACCOUNTING TECHNICIAN	1.00	1.00	1.00	0.00
80P22	PHOTOCOPYIST	2.00	2.00	2.00	0.00
80R11	ASSESSMENT CLERK	1.00	1.00	0.00	(1.00)
80R22	PROPERTY TRANSFER CLERK	4.00	4.00	3.00	(1.00)
80R23	SENIOR PROPERTY TRANSFER CLERK	1.00	1.00	1.00	0.00
Total Assessor-County Clerk-Recorder		69.00	69.00	65.00	(4.00)

County Counsel

11A04	COUNTY COUNSEL	1.00	1.00	1.00	0.00
12C38	ASSISTANT COUNTY COUNSEL	1.00	2.00	2.00	0.00
12C39	CHIEF ASSISTANT COUNTY COUNSEL	1.00	1.00	1.00	0.00
14B62	ASSOCIATE RISK & BENEFITS ANALYST	1.00	1.00	1.00	0.00
14B63	SENIOR RISK & BENEFITS ANALYST	1.00	1.00	1.00	0.00
14B64	PRINCIPAL RISK & BENEFITS ANALYST	1.00	1.00	1.00	0.00
14C30	MANAGEMENT ANALYST II	1.00	1.00	1.00	0.00
14C31	MANAGEMENT ANALYST III	2.00	2.00	2.00	0.00
14C32	SAFETY OFFICER	1.00	1.00	1.00	0.00
14C85	WORKERS COMPENSATION MANAGER	1.00	1.00	1.00	0.00
14C86	ERGONOMICS MANAGER	1.00	1.00	1.00	0.00
14N05	ADMINISTRATIVE OPERATIONS MANAGER	0.00	0.00	1.00	1.00
20B93	FINANCE MANAGER II	0.00	0.00	1.00	1.00
20B95	FINANCE MANAGER I	1.00	1.00	0.00	(1.00)
39B23	DEPUTY COUNTY COUNSEL IV	15.00	15.00	14.00	(1.00)
39B25	CHIEF DEPUTY COUNTY COUNSEL	4.00	3.00	3.00	0.00
74K50	SAFETY COORDINATOR/INVESTIGATOR	3.00	3.00	3.00	0.00
80A34	SENIOR SECRETARY-CONFIDENTIAL	1.00	1.00	1.00	0.00
80A99	ADMINISTRATIVE SECRETARY-CONFIDENTIAL	1.00	1.00	1.00	0.00
80B26	LEGAL SECRETARY III	7.00	7.00	7.00	0.00

Adopted FY 2022-23 to Recommended FY 2023-24 Positions

Classification Code	Classification Label	Adopted Budget 2021-2022	Adopted Budget 2022-2023	Recommended Budget 2023-2024	Change
99ZWC	ALLOCATION ON LOAN WORK COMP	10.00	10.00	10.00	0.00
Total County Counsel		54.00	54.00	54.00	0.00
Clerk of the Board					
11A30	CLERK OF THE BOARD OF SUPERVISORS	1.00	1.00	1.00	0.00
14G02	MANAGEMENT ANALYST I	1.00	1.00	1.00	0.00
80E83	BOARD OF SUPERVISORS CLERK	3.00	3.00	3.00	0.00
Total Clerk of the Board		5.00	5.00	5.00	0.00
Elections					
11A20	REGISTRAR OF VOTERS	1.00	1.00	1.00	0.00
12C14	ASSISTANT REGISTRAR OF VOTERS	1.00	1.00	1.00	0.00
14C30	MANAGEMENT ANALYST II	1.00	1.00	1.00	0.00
14J21	ELECTIONS SERVICES SPECIALIST II	2.00	2.00	2.00	0.00
14M80	ELECTIONS PROGRAM MANAGER	5.00	5.00	5.00	0.00
16C87	BUSINESS TECHNOLOGY ANALYST II	1.00	1.00	1.00	0.00
43J09	SENIOR DEPARTMENTAL INFORMATION SYSTEMS COORDINATOR	1.00	1.00	1.00	0.00
Total Elections		12.00	12.00	12.00	0.00
Emergency Communications					
12C42	EMERGENCY COMMUNICATIONS OPERATIONS MANAGER	1.00	1.00	1.00	0.00
14A26	DIRECTOR OF EMERGENCY COMMUNICATIONS	1.00	1.00	1.00	0.00
14C31	MANAGEMENT ANALYST III	3.00	3.00	0.00	(3.00)
14C70	ADMINISTRATIVE SERVICES ASSISTANT	1.00	1.00	1.00	0.00
14M13	EMERGENCY COMMUNICATIONS MANAGER	0.00	0.00	3.00	3.00
20B93	FINANCE MANAGER II	1.00	1.00	1.00	0.00
43J05	DEPARTMENTAL INFORMATION SYSTEMS COORDINATOR	0.00	1.00	1.00	0.00
43J09	SENIOR DEPARTMENTAL INFORMATION SYSTEMS COORDINATOR	1.00	1.00	1.00	0.00
80A99	ADMINISTRATIVE SECRETARY-CONFIDENTIAL	1.00	1.00	1.00	0.00
80S01	COMMUNICATIONS DISPATCHER I	6.00	6.00	6.00	0.00
80S21	COMMUNICATIONS DISPATCHER II	50.00	50.00	50.00	0.00
80S22	EMERGENCY COMMUNICATIONS SHIFT SUPERVISOR	10.00	9.00	9.00	0.00
Total Emergency Communications		75.00	75.00	75.00	0.00
Information Technology					
12C43	DEPUTY CHIEF INFORMATION OFFICER	2.00	2.00	2.00	0.00
12E18	CHIEF INFORMATION OFFICER	1.00	1.00	1.00	0.00
14B32	SENIOR PERSONNEL ANALYST	1.00	1.00	1.00	0.00
14C30	MANAGEMENT ANALYST II	2.00	2.00	2.00	0.00
14C31	MANAGEMENT ANALYST III	1.00	1.00	1.00	0.00
14H03	PERSONNEL TECHNICIAN-CONFIDENTIAL	1.00	1.00	1.00	0.00
14K52	CHIEF SECURITY OFFICER	1.00	1.00	1.00	0.00
14P20	INFORMATION TECHNOLOGY ARCHITECT	3.00	3.00	3.00	0.00
16C23	INFORMATION TECHNOLOGY SUPERVISOR	0.00	0.00	0.00	0.00
16C43	SOFTWARE ENGINEER I	1.00	1.00	1.00	0.00
16C44	SOFTWARE ENGINEER II	6.00	6.00	6.00	0.00
16C45	SOFTWARE ENGINEER III	17.00	17.00	17.00	0.00
16C54	INFORMATION TECHNOLOGY SYSTEMS ANALYST II	6.00	7.00	8.00	1.00
16C55	INFORMATION TECHNOLOGY SYSTEMS ANALYST III	19.00	19.00	19.00	0.00
16C86	BUSINESS TECHNOLOGY ANALYST I	1.00	0.00	0.00	0.00
16E25	INFORMATION TECHNOLOGY SECURITY ENGINEER III	2.00	2.00	2.00	0.00
16F41	DEPARTMENTAL INFORMATION SYSTEMS MANAGER II	1.00	1.00	0.00	(1.00)
16G24	GIS ANALYST II	1.00	1.00	1.00	0.00
16G25	GIS ANALYST III	2.00	2.00	2.00	0.00

Adopted FY 2022-23 to Recommended FY 2023-24 Positions

Classification Code	Classification Label	Adopted Budget 2021-2022	Adopted Budget 2022-2023	Recommended Budget 2023-2024	Change
20B11	ACCOUNTANT II	1.00	1.00	1.00	0.00
20B93	FINANCE MANAGER II	1.00	1.00	1.00	0.00
41N24	NETWORK SYSTEMS ENGINEER II	4.00	4.00	5.00	1.00
41N25	NETWORK SYSTEMS ENGINEER III	4.00	4.00	4.00	0.00
43A21	ENGINEERING AIDE II	1.00	1.00	1.00	0.00
43G01	INFORMATION TECHNOLOGY MANAGER	8.00	8.00	9.00	1.00
43G03	INFORMATION TECHNOLOGY PROJECT MANAGER II	3.00	3.00	3.00	0.00
43G04	INFORMATION TECHNOLOGY PROJECT MANAGER III	3.00	3.00	3.00	0.00
43J05	DEPARTMENTAL INFORMATION SYSTEMS COORDINATOR	1.00	1.00	0.00	(1.00)
43L41	RADIO COMMUNICATIONS ENGINEER	2.00	2.00	2.00	0.00
43M35	INFORMATION TECHNOLOGY SUPPORT SPECIALIST	7.00	7.00	6.00	(1.00)
70F80	SENIOR STOREKEEPER	1.00	1.00	1.00	0.00
80A99	ADMINISTRATIVE SECRETARY-CONFIDENTIAL	1.00	1.00	1.00	0.00
80E80	PRINCIPAL OFFICE ASSISTANT	2.00	2.00	2.00	0.00
80J30	ACCOUNTING TECHNICIAN	3.00	3.00	3.00	0.00
Total Information Technology		110.00	110.00	110.00	0.00

District Attorney

10B04	DISTRICT ATTORNEY	1.00	1.00	1.00	0.00
12A03	CHIEF ASSISTANT DISTRICT ATTORNEY	1.00	1.00	1.00	0.00
12A04	ASSISTANT DISTRICT ATTORNEY	3.00	4.00	4.00	0.00
14C30	MANAGEMENT ANALYST II	1.00	1.00	1.00	0.00
14C70	ADMINISTRATIVE SERVICES ASSISTANT	0.00	0.00	1.00	1.00
14C75	ADMINISTRATIVE ASSISTANT TO DISTRICT ATTORNEY	1.00	1.00	1.00	0.00
14C87	VICTIM/WITNESS ASSISTANCE PROGRAM MANAGER	1.00	1.00	1.00	0.00
14K60	CHIEF DISTRICT ATTORNEY INVESTIGATOR	1.00	1.00	1.00	0.00
20B10	ACCOUNTANT I	1.00	1.00	1.00	0.00
20B11	ACCOUNTANT II	1.00	1.00	1.00	0.00
20B12	ACCOUNTANT III	2.00	2.00	2.00	0.00
20B93	FINANCE MANAGER II	1.00	1.00	1.00	0.00
34A20	DISTRICT ATTORNEY INVESTIGATOR I	5.00	5.00	5.00	0.00
34A22	DISTRICT ATTORNEY INVESTIGATOR III	21.00	21.00	21.00	0.00
34A80	DISTRICT ATTORNEY INVESTIGATIVE CAPTAIN	2.00	2.00	2.00	0.00
34G10	INVESTIGATIVE AIDE	6.00	6.00	6.00	0.00
39C01	LEGAL ASSISTANT	4.00	4.00	4.00	0.00
39D31	DEPUTY DISTRICT ATTORNEY IV	54.00	55.00	54.00	(1.00)
39D32	CHIEF DEPUTY DISTRICT ATTORNEY	1.00	0.00	1.00	1.00
43G05	DIGITAL FORENSIC INVESTIGATOR	1.00	1.00	1.00	0.00
43J05	DEPARTMENTAL INFORMATION SYSTEMS COORDINATOR	0.00	0.00	1.00	1.00
60K02	VICTIM ASSISTANCE ADVOCATE	10.00	10.00	10.00	0.00
60K03	VICTIM/WITNESS ASSISTANCE PROGRAM COORDINATOR	1.00	1.00	2.00	1.00
80B11	LEGAL TYPIST	7.00	7.00	7.00	0.00
80B22	LEGAL SECRETARY II	28.00	28.00	24.00	(4.00)
80B24	SUPERVISING LEGAL SECRETARY	3.00	3.00	3.00	0.00
80B26	LEGAL SECRETARY III	0.00	0.00	3.00	3.00
Total District Attorney		157.00	158.00	160.00	2.00

Child Support Services

11A26	DIRECTOR OF CHILD SUPPORT SERVICES	1.00	1.00	1.00	0.00
14C30	MANAGEMENT ANALYST II	1.00	1.00	1.00	0.00
14C31	MANAGEMENT ANALYST III	1.00	0.00	0.00	0.00
14K62	DEPUTY DIRECTOR CHILD SUPPORT SERVICES	1.00	1.00	1.00	0.00

Adopted FY 2022-23 to Recommended FY 2023-24 Positions

Classification Code	Classification Label	Adopted Budget 2021-2022	Adopted Budget 2022-2023	Recommended Budget 2023-2024	Change
20B11	ACCOUNTANT II	1.00	1.00	1.00	0.00
20B95	FINANCE MANAGER I	1.00	1.00	1.00	0.00
25C18	CHILD SUPPORT ASSISTANT II	5.00	5.00	5.00	0.00
25C23	CHILD SUPPORT OFFICER II	40.00	40.00	40.00	0.00
25C24	CHILD SUPPORT OFFICER III	8.00	8.00	8.00	0.00
25C81	SUPERVISING CHILD SUPPORT OFFICER	5.00	5.00	5.00	0.00
25C82	CHILD SUPPORT PERFORMANCE SPECIALIST	1.00	1.00	1.00	0.00
34G21	CIVIL PROCESS SERVER	1.00	1.00	1.00	0.00
34G22	SENIOR CIVIL PROCESS SERVER	1.00	1.00	1.00	0.00
39A47	CHIEF CHILD SUPPORT ATTORNEY	1.00	1.00	1.00	0.00
39D36	CHILD SUPPORT ATTORNEY IV	3.00	3.00	3.00	0.00
70F21	COURIER	1.00	1.00	1.00	0.00
80B22	LEGAL SECRETARY II	1.00	1.00	1.00	0.00
80D23	LEGAL PROCESS CLERK	1.00	1.00	1.00	0.00
80E21	OFFICE ASSISTANT II	1.00	1.00	1.00	0.00
80E80	PRINCIPAL OFFICE ASSISTANT	1.00	1.00	1.00	0.00
80J20	ACCOUNTING CLERICAL SUPERVISOR	1.00	1.00	1.00	0.00
80J21	ACCOUNT CLERK	3.00	3.00	3.00	0.00
80J22	SENIOR ACCOUNT CLERK	1.00	1.00	1.00	0.00
80J30	ACCOUNTING TECHNICIAN	2.00	2.00	2.00	0.00
Total Child Support Services		83.00	82.00	82.00	0.00
Public Defender					
11A18	PUBLIC DEFENDER	1.00	1.00	1.00	0.00
12A06	CHIEF ASSISTANT PUBLIC DEFENDER	0.00	1.00	1.00	0.00
12C11	ASSISTANT PUBLIC DEFENDER	1.00	1.00	2.00	1.00
14C30	MANAGEMENT ANALYST II	1.00	2.00	2.00	0.00
14G02	MANAGEMENT ANALYST I	1.00	0.00	0.00	0.00
20B10	ACCOUNTANT I	1.00	1.00	1.00	0.00
20B95	FINANCE MANAGER I	1.00	1.00	1.00	0.00
34D40	PUBLIC DEFENDER INVESTIGATOR III	6.00	6.00	6.00	0.00
34D78	CHIEF PUBLIC DEFENDER INVESTIGATOR	1.00	1.00	1.00	0.00
39P31	DEPUTY PUBLIC DEFENDER IV	26.00	26.00	26.00	0.00
39P35	CHIEF DEPUTY PUBLIC DEFENDER	4.00	4.00	4.00	0.00
60B21	PSYCHIATRIC SOCIAL WORKER II	1.00	1.00	1.00	0.00
80A99	ADMINISTRATIVE SECRETARY-CONFIDENTIAL	1.00	1.00	1.00	0.00
80B22	LEGAL SECRETARY	9.00	9.00	9.00	0.00
80B23	SENIOR LEGAL SECRETARY	1.00	1.00	0.00	(1.00)
80B24	SUPERVISING LEGAL SECRETARY	1.00	1.00	1.00	0.00
80B26	LEGAL SECRETARY III	0.00	0.00	1.00	1.00
80E21	OFFICE ASSISTANT II	1.00	1.00	0.00	(1.00)
80E22	OFFICE ASSISTANT III	0.00	0.00	1.00	1.00
80J21	ACCOUNT CLERK	0.50	1.00	1.00	0.00
Total Public Defender		57.50	59.00	60.00	1.00
Sheriff-Coroner					
10B05	SHERIFF	1.00	1.00	1.00	0.00
12A10	CHIEF DEPUTY SHERIFF	3.00	3.00	3.00	0.00
12A13	UNDERSHERIFF	1.00	1.00	1.00	0.00
14B01	PERSONNEL ANALYST	1.00	1.00	1.00	0.00
14C30	MANAGEMENT ANALYST II	1.00	1.00	0.00	(1.00)
14C31	MANAGEMENT ANALYST III	3.00	3.00	3.00	0.00

Adopted FY 2022-23 to Recommended FY 2023-24 Positions

Classification Code	Classification Label	Adopted Budget 2021-2022	Adopted Budget 2022-2023	Recommended Budget 2023-2024	Change
14G02	MANAGEMENT ANALYST I	0.00	1.00	1.00	0.00
14H33	CRIMINAL INTELLIGENCE SPECIALIST	2.00	2.00	2.00	0.00
16F41	DEPARTMENTAL INFORMATION SYSTEMS MANAGER II	1.00	1.00	1.00	0.00
20B11	ACCOUNTANT II	1.00	1.00	1.00	0.00
20B12	ACCOUNTANT III	1.00	1.00	1.00	0.00
20B93	FINANCE MANAGER II	1.00	1.00	1.00	0.00
34E22	FORENSIC EVIDENCE TECHNICIAN	2.00	2.00	2.00	0.00
34E30	SUPERVISING FORENSIC EVIDENCE TECHNICIAN	1.00	1.00	1.00	0.00
34G21	CIVIL PROCESS SERVER	1.00	1.00	1.00	0.00
34P31	VEHICLE ABATEMENT ENFORCEMENT OFFICER	2.00	2.00	2.00	0.00
36A22	DEPUTY SHERIFF-OPERATIONS	111.00	112.00	112.00	0.00
36A23	SHERIFFS SERGEANT	34.00	34.00	34.00	0.00
36A24	SHERIFFS INVESTIGATIVE SERGEANT	3.00	3.00	3.00	0.00
36A81	SHERIFFS CAPTAIN	1.00	1.00	1.00	0.00
36A82	SHERIFFS COMMANDER	9.00	9.00	9.00	0.00
36E21	DEPUTY SHERIFF-CORRECTIONS	154.00	153.00	153.00	0.00
43G05	DIGITAL FORENSIC INVESTIGATOR	1.00	1.00	1.00	0.00
43J09	SENIOR DEPARTMENTAL INFORMATION SYSTEMS COORDINATOR	3.00	3.00	3.00	0.00
43J15	SUPERVISING DEPARTMENTAL INFORMATION SYSTEMS COORDINATOR	1.00	1.00	1.00	0.00
50S01	FORENSIC AUTOPSY TECHNICIAN	1.00	2.00	2.00	0.00
60G54	SHERIFF'S WORK ALTERNATIVE SPECIALIST	4.00	4.00	4.00	0.00
60I02	PROGRAM MANAGER II	0.00	0.00	1.00	1.00
60S21	CRIME PREVENTION SPECIALIST	1.00	1.00	1.00	0.00
70F80	SENIOR STOREKEEPER	1.00	1.00	1.00	0.00
70K92	SHERIFFS CORRECTIONAL COOK II	5.00	5.00	5.00	0.00
70N10	INMATE SERVICES SPECIALIST	5.00	5.00	5.00	0.00
72A40	SENIOR INMATE SERVICES SPECIALIST	1.00	1.00	1.00	0.00
72C25	VEHICLE MAINTENANCE COORDINATOR	1.00	1.00	1.00	0.00
80A32	SENIOR SECRETARY	1.00	1.00	1.00	0.00
80A34	SENIOR SECRETARY-CONFIDENTIAL	1.00	1.00	1.00	0.00
80A99	ADMINISTRATIVE SECRETARY-CONFIDENTIAL	1.00	1.00	1.00	0.00
80E22	OFFICE ASSISTANT III	3.00	3.00	3.00	0.00
80H25	MEDICAL TRANSCRIPTIONIST II	1.00	0.00	0.00	0.00
80I01	SENIOR CIVIL CLERK	1.00	1.00	1.00	0.00
80I06	SHERIFFS PROPERTY TECHNICIAN	2.00	2.00	2.00	0.00
80I07	CORRECTIONS SPECIALIST	11.00	11.00	11.00	0.00
80I08	SENIOR CORRECTIONS SPECIALIST	3.00	3.00	3.00	0.00
80I10	CUSTODY AND CONTROL SPECIALIST	47.00	47.00	47.00	0.00
80I15	SHERIFFS RECORDS SPECIALIST I	2.00	2.00	2.00	0.00
80I16	SHERIFFS RECORDS SPECIALIST II	18.00	18.00	18.00	0.00
80I17	SENIOR SHERIFFS RECORDS SPECIALIST	5.00	5.00	5.00	0.00
80I20	SHERIFFS RECORDS SUPERVISOR	4.00	4.00	4.00	0.00
80J20	ACCOUNTING CLERICAL SUPERVISOR	1.00	1.00	1.00	0.00
80J21	ACCOUNT CLERK	1.00	1.00	1.00	0.00
80J22	SENIOR ACCOUNT CLERK	3.00	3.00	3.00	0.00
80J30	ACCOUNTING TECHNICIAN	4.00	4.00	4.00	0.00
Total Sheriff-Coroner		467.00	468.00	468.00	0.00
Probation					
11A06	CHIEF PROBATION OFFICER	1.00	1.00	1.00	0.00
12C35	ASSISTANT CHIEF PROBATION OFFICER	1.00	1.00	1.00	0.00

Adopted FY 2022-23 to Recommended FY 2023-24 Positions

Classification Code	Classification Label	Adopted Budget 2021-2022	Adopted Budget 2022-2023	Recommended Budget 2023-2024	Change
14B32	SENIOR PERSONNEL ANALYST	0.00	1.00	1.00	0.00
14C30	MANAGEMENT ANALYST II	4.00	3.00	3.00	0.00
14C31	MANAGEMENT ANALYST III	2.00	2.00	2.00	0.00
14H03	PERSONNEL TECHNICIAN-CONFIDENTIAL	1.00	1.00	1.00	0.00
16C87	BUSINESS TECHNOLOGY ANALYST II	2.00	2.00	2.00	0.00
16F41	DEPARTMENTAL INFORMATION SYSTEMS MANAGER II	1.00	1.00	1.00	0.00
20B10	ACCOUNTANT I	2.00	2.00	2.00	0.00
20B11	ACCOUNTANT II	1.00	1.00	1.00	0.00
20B12	ACCOUNTANT III	1.00	1.00	1.00	0.00
20B93	FINANCE MANAGER II	1.00	1.00	1.00	0.00
43J09	SENIOR DEPARTMENTAL INFORMATION SYSTEMS COORDINATOR	1.00	1.00	1.00	0.00
60F02	PROBATION AIDE	15.50	18.50	19.50	1.00
60F22	DEPUTY PROBATION OFFICER II	72.00	73.00	74.00	1.00
60F23	DEPUTY PROBATION OFFICER III	24.00	25.00	25.00	0.00
60F84	PROBATION SERVICES MANAGER	14.00	14.00	14.00	0.00
60F85	PROBATION DIVISION MANAGER	4.00	4.00	4.00	0.00
60F87	JUVENILE INSTITUTIONS SUPERVISOR	9.00	9.00	9.00	0.00
60F89	JUVENILE INSTITUTIONS OFFICER II	73.00	73.00	73.00	0.00
60F90	SENIOR JUVENILE INSTITUTIONS OFFICER	13.00	13.00	13.00	0.00
60I02	PROGRAM MANAGER II	1.00	1.00	1.00	0.00
60K02	VICTIM ASSISTANCE ADVOCATE	2.00	2.00	2.00	0.00
70K23	COOK	0.00	5.00	5.00	0.00
70K25	SENIOR COOK	4.50	1.00	1.00	0.00
70K80	HEAD COOK	1.00	1.00	1.00	0.00
70K83	FOOD ADMINISTRATOR-PROBATION	1.00	1.00	1.00	0.00
70L01	LAUNDRY WORKER I	1.00	1.00	0.00	(1.00)
72A23	BUILDING MAINTENANCE WORKER	0.00	0.00	1.00	1.00
72A29	SENIOR BUILDING MAINTENANCE WORKER	1.00	1.00	1.00	0.00
80A30	SECRETARIAL ASSISTANT	1.00	1.00	1.00	0.00
80A32	SENIOR SECRETARY	1.00	1.00	1.00	0.00
80A99	ADMINISTRATIVE SECRETARY-CONFIDENTIAL	1.00	1.00	1.00	0.00
80E21	OFFICE ASSISTANT II	14.00	16.00	16.00	0.00
80E22	OFFICE ASSISTANT III	7.00	7.00	8.00	1.00
80E82	SUPERVISING OFFICE ASSISTANT II	2.00	2.00	2.00	0.00
80J22	SENIOR ACCOUNT CLERK	1.00	1.00	1.00	0.00
80J30	ACCOUNTING TECHNICIAN	4.00	4.00	4.00	0.00
80W21	WORD PROCESSOR	3.00	3.00	2.00	(1.00)
Total Probation		288.00	296.50	298.50	2.00
Agricultural Commissioner					
11A02	AGRICULTURAL COMMISSIONER	1.00	1.00	1.00	0.00
12C01	ASSISTANT AGRICULTURAL COMMISSIONER	1.00	1.00	1.00	0.00
14B32	SENIOR PERSONNEL ANALYST	1.00	1.00	1.00	0.00
14C31	MANAGEMENT ANALYST III	1.00	1.00	1.00	0.00
14H03	PERSONNEL TECHNICIAN-CONFIDENTIAL	1.00	1.00	1.00	0.00
16G25	GIS ANALYST III	1.00	1.00	1.00	0.00
20B10	ACCOUNTANT I	1.00	1.00	1.00	0.00
20B95	FINANCE MANAGER I	1.00	1.00	1.00	0.00
30G22	WEIGHTS/MEASURES INSPECTOR III	5.50	5.00	5.00	0.00
30N05	AGRICULTURAL ASSISTANT II	11.00	11.00	11.00	0.00
30N22	AGRICULTURAL INSPECTOR/BIOLOGIST III	31.00	32.00	32.00	0.00

Adopted FY 2022-23 to Recommended FY 2023-24 Positions

Classification Code	Classification Label	Adopted Budget 2021-2022	Adopted Budget 2022-2023	Recommended Budget 2023-2024	Change
30N50	AGRICULTURAL PROGRAMS BIOLOGIST	1.00	1.00	1.00	0.00
30N80	DEPUTY AGRICULTURAL COMMISSIONER	8.00	8.00	8.00	0.00
30N81	CHIEF DEPUTY AGRICULTURAL COMMISSIONER	3.00	3.00	3.00	0.00
43J15	SUPERVISING DEPARTMENTAL INFORMATION SYSTEMS COORDINATOR	1.00	1.00	1.00	0.00
80A99	ADMINISTRATIVE SECRETARY-CONFIDENTIAL	1.00	1.00	1.00	0.00
80E22	OFFICE ASSISTANT III	2.00	2.00	2.00	0.00
80G21	DATA ENTRY OPERATOR II	1.00	1.00	1.00	0.00
80J22	SENIOR ACCOUNT CLERK	1.00	1.00	1.00	0.00
80J30	ACCOUNTING TECHNICIAN	1.00	1.00	1.00	0.00
Total Agricultural Commissioner		74.50	75.00	75.00	0.00

Housing and Community Development

11A34	DIRECTOR OF HOUSING AND COMMUNITY DEVELOPMENT	1.00	1.00	1.00	0.00
14C30	MANAGEMENT ANALYST II	5.00	5.00	4.00	(1.00)
14C31	MANAGEMENT ANALYST III	1.00	1.00	1.00	0.00
14G02	MANAGEMENT ANALYST I	1.00	1.00	1.00	0.00
14H30	RMA OMBUDSPERSON	0.00	0.00	1.00	1.00
14K46	PERMIT CENTER MANAGER	0.00	1.00	1.00	0.00
14K47	BUILDING SERVICES MANAGER	0.00	1.00	1.00	0.00
14K50	CHIEF OF PLANNING	1.00	1.00	1.00	0.00
14K51	PRINCIPAL PLANNER	0.00	3.00	2.00	(1.00)
14K51	RMA SERVICES MANAGER	5.00	0.00	0.00	0.00
14M22	HOUSING PROGRAM MANAGER	1.00	1.00	1.00	0.00
20B10	ACCOUNTANT I	1.00	1.00	1.00	0.00
20B95	FINANCE MANAGER I	2.00	2.00	2.00	0.00
30D21	BUILDING INSPECTOR II	5.00	5.00	5.00	0.00
30D22	SENIOR BUILDING INSPECTOR	1.00	1.00	1.00	0.00
30D25	CHIEF OF BUILDING SERVICES	1.00	1.00	1.00	0.00
34P26	CODE COMPLIANCE INSPECTOR II	6.00	8.00	8.00	0.00
34P27	SENIOR CODE COMPLIANCE INSPECTOR	1.00	1.00	1.00	0.00
41A10	ASSISTANT ENGINEER	2.00	2.00	2.00	0.00
41A20	CIVIL ENGINEER	1.00	1.00	1.00	0.00
41A22	SENIOR CIVIL ENGINEER	1.00	1.00	1.00	0.00
41B21	BUILDING PLANS EXAMINER	4.00	4.00	4.00	0.00
41C02	WATER RESOURCES HYDROLOGIST	2.00	2.00	2.00	0.00
41C14	ASSOCIATE WATER RESOURCES HYDROLOGIST	1.00	1.00	1.00	0.00
41F11	ASSOCIATE PLANNER	12.00	12.00	12.00	0.00
41F22	SENIOR PLANNER	4.00	4.00	4.00	0.00
41F23	SUPERVISING PLANNER	2.00	2.00	2.00	0.00
41F30	REDEVELOPMENT/HOUSING PROJECT ANALYST I	1.00	1.00	0.00	(1.00)
41F31	REDEVELOPMENT/HOUSING PROJECT ANALYST II	0.00	0.00	1.00	1.00
41F32	REDEVELOPMENT/HOUSING PROJECT ANALYST III	1.00	1.00	1.00	0.00
43A22	ENGINEERING AIDE III	1.00	1.00	1.00	0.00
43A23	ENGINEERING TECHNICIAN	2.00	2.00	2.00	0.00
43B03	WATER RESOURCES TECHNICIAN	1.00	2.00	2.00	0.00
43C10	PERMIT TECHNICIAN I	3.00	3.00	3.00	0.00
43C11	PERMIT TECHNICIAN II	5.00	5.00	5.00	0.00
43C12	PERMIT TECHNICIAN III	1.00	1.00	2.00	1.00
80A31	SECRETARY	2.00	2.00	2.00	0.00
80A32	SENIOR SECRETARY	2.00	2.00	2.00	0.00
80A33	ADMINISTRATIVE SECRETARY	2.00	1.00	1.00	0.00

Adopted FY 2022-23 to Recommended FY 2023-24 Positions

Classification Code	Classification Label	Adopted Budget 2021-2022	Adopted Budget 2022-2023	Recommended Budget 2023-2024	Change
80A99	ADMINISTRATIVE SECRETARY-CONFIDENTIAL	0.00	1.00	1.00	0.00
80E01	OFFICE ASSISTANT I	1.00	1.00	1.00	0.00
80E21	OFFICE ASSISTANT II	9.00	10.00	10.00	0.00
80E22	OFFICE ASSISTANT III	3.00	3.00	3.00	0.00
80E80	PRINCIPAL OFFICE ASSISTANT	0.00	1.00	1.00	0.00
80E81	SUPERVISING OFFICE ASSISTANT I	1.00	0.00	0.00	0.00
80E82	SUPERVISING OFFICE ASSISTANT II	1.00	1.00	1.00	0.00
80J22	SENIOR ACCOUNT CLERK	1.00	1.00	1.00	0.00
80J30	ACCOUNTING TECHNICIAN	1.00	1.00	1.00	0.00
Total Housing and Community Development		99.00	103.00	103.00	0.00
Public Works, Facilities & Parks					
11A33	DIRECTOR OF PUBLIC WORKS, FACILITIES AND PARKS	1.00	1.00	1.00	0.00
12C23	ASSISTANT DIRECTOR OF PUBLIC WORKS, FACILITIES AND PARKS	1.00	1.00	1.00	0.00
14A10	PROJECT MANAGER I	1.00	1.00	1.00	0.00
14A11	PROJECT MANAGER II	5.00	5.00	5.00	0.00
14A12	PROJECT MANAGER III	4.00	4.00	4.00	0.00
14B21	ASSOCIATE PERSONNEL ANALYST	0.00	0.00	1.00	1.00
14B32	SENIOR PERSONNEL ANALYST	0.00	0.00	1.00	1.00
14C30	MANAGEMENT ANALYST II	8.00	9.00	8.00	(1.00)
14C31	MANAGEMENT ANALYST III	3.00	4.00	4.00	0.00
14C70	ADMINISTRATIVE SERVICES ASSISTANT	1.00	1.00	1.00	0.00
14C74	REAL PROPERTY SPECIALIST	1.00	1.00	1.00	0.00
14E01	BUYER I	0.00	1.00	1.00	0.00
14G02	MANAGEMENT ANALYST I	0.00	2.00	1.00	(1.00)
14H03	PERSONNEL TECHNICIAN-CONFIDENTIAL	0.00	0.00	1.00	1.00
14H64	FLEET MANAGER	0.00	1.00	1.00	0.00
14K48	CAPITAL IMPROVEMENT MANAGER	0.00	1.00	2.00	1.00
14K51	RMA SERVICES MANAGER	1.00	0.00	0.00	0.00
14K63	CHIEF OF FACILITIES	1.00	1.00	1.00	0.00
14K70	CHIEF OF PARKS	1.00	1.00	1.00	0.00
14N05	ADMINISTRATIVE OPERATIONS MANAGER	2.00	3.00	4.00	1.00
16G24	GIS ANALYST II	0.00	1.00	1.00	0.00
20B10	ACCOUNTANT I	1.00	3.00	3.00	0.00
20B11	ACCOUNTANT II	2.00	3.00	3.00	0.00
20B12	ACCOUNTANT III	1.00	2.00	2.00	0.00
20B93	FINANCE MANAGER II	1.00	1.00	1.00	0.00
20B94	FINANCE MANAGER III	1.00	1.00	1.00	0.00
20B95	FINANCE MANAGER I	2.00	2.00	2.00	0.00
30D31	CHIEF OF PUBLIC WORKS	1.00	1.00	1.00	0.00
34X21	GUARD	2.00	2.00	2.00	0.00
41A10	ASSISTANT ENGINEER	8.00	10.00	9.00	(1.00)
41A20	CIVIL ENGINEER	3.00	5.00	4.00	(1.00)
41A22	SENIOR CIVIL ENGINEER	3.00	3.00	3.00	0.00
41A87	CHIEF OF SURVEYS	1.00	1.00	1.00	0.00
41C02	WATER RESOURCES HYDROLOGIST	1.00	1.00	1.00	0.00
41C14	ASSOCIATE WATER RESOURCES HYDROLOGIST	0.00	1.00	1.00	0.00
41C17	SENIOR WATER RESOURCES HYDROLOGIST	1.00	1.00	1.00	0.00
41F85	PARKS PLANNING MANAGER	1.00	1.00	1.00	0.00
43A22	ENGINEERING AIDE III	1.00	0.00	0.00	0.00
43A23	ENGINEERING TECHNICIAN	3.00	6.00	8.00	2.00

Adopted FY 2022-23 to Recommended FY 2023-24 Positions

Classification Code	Classification Label	Adopted Budget 2021-2022	Adopted Budget 2022-2023	Recommended Budget 2023-2024	Change
43B03	WATER RESOURCES TECHNICIAN	1.00	1.00	1.00	0.00
43L18	COMMUNICATIONS TECHNICIAN III	0.00	1.00	1.00	0.00
43L20	COMMUNICATIONS TECHNICIAN I	0.00	1.00	1.00	0.00
43L42	VEHICLE INSTALLATION SPECIALIST	0.00	0.00	1.00	1.00
65C10	PARKS MUSEUM ASSISTANT	1.00	1.00	1.00	0.00
68A30	RANGE MASTER	0.00	1.00	1.00	0.00
68A41	COUNTY PARK RANGER II	2.00	3.00	3.00	0.00
68A42	COUNTY PARK RANGER III	2.00	2.00	2.00	0.00
68A43	COUNTY PARK RANGER SUPERVISOR	1.00	1.00	1.00	0.00
68C01	PARK SERVICES AIDE I	3.00	3.00	3.00	0.00
68C02	RANGE AIDE	0.00	1.00	1.00	0.00
68C21	PARK SERVICES AIDE II	1.00	2.00	2.00	0.00
68C23	PARK SERVICES AIDE III	1.00	1.00	1.00	0.00
70C20	SENIOR GROUNDSKEEPER	1.00	1.00	1.00	0.00
70C21	GROUNDSKEEPER	4.00	4.00	4.00	0.00
70C80	GROUNDS SUPERVISOR	1.00	1.00	1.00	0.00
70F10	FLEET PARTS COORDINATOR	0.00	1.00	1.00	0.00
70F12	SENIOR FLEET PARTS COORDINATOR	0.00	1.00	1.00	0.00
70F21	COURIER	0.00	5.00	5.00	0.00
70F23	STOREKEEPER	0.00	5.00	5.00	0.00
70F81	SUPERVISING STOREKEEPER	0.00	1.00	1.00	0.00
70N01	OFFICE MAINTENANCE WORKER	2.00	2.00	2.00	0.00
72A23	BUILDING MAINTENANCE WORKER	12.00	12.00	12.00	0.00
72A29	SENIOR BUILDING MAINTENANCE WORKER	2.00	2.00	2.00	0.00
72A81	BUILDING MAINTENANCE SUPERVISOR	3.00	3.00	3.00	0.00
72B31	PARKS BUILDING & GROUNDS WORKER II	9.00	10.00	10.00	0.00
72B32	PARKS BUILDING & GROUNDS WORKER SUPERVISOR	3.00	3.00	5.00	2.00
72B40	PARKS UTILITIES & WATER SYSTEMS SPECIALIST	3.00	3.00	3.00	0.00
72B41	SENIOR PARKS UTILITIES & WATER SYSTEMS SPECIALIST	1.00	1.00	1.00	0.00
72C20	MECHANIC I	0.00	2.00	1.00	(1.00)
72C23	MECHANIC II	0.00	11.00	11.00	0.00
72C26	MECHANIC III	0.00	2.00	2.00	0.00
72C82	SUPERVISING MECHANIC	0.00	0.00	1.00	1.00
72C83	FLEET SERVICE WRITER	0.00	1.00	1.00	0.00
74D12	ROAD MAINTENANCE WORKER	19.00	23.00	28.00	5.00
74D13	SENIOR ROAD MAINTENANCE WORKER	8.00	8.00	8.00	0.00
74D81	ASSISTANT ROAD SUPERINTENDENT	4.00	5.00	5.00	0.00
74D83	ROAD SUPERINTENDENT	4.00	4.00	4.00	0.00
74D84	ROAD MAINTENANCE SUPERINTENDENT	1.00	1.00	1.00	0.00
74D85	MAINTENANCE MANAGER	2.00	2.00	2.00	0.00
74E11	BRIDGE MAINTENANCE WORKER	4.00	5.00	6.00	1.00
74E31	SENIOR BRIDGE MAINTENANCE WORKER	1.00	1.00	1.00	0.00
74E80	ASSISTANT BRIDGE SUPERINTENDENT	1.00	1.00	1.00	0.00
74E81	BRIDGE SUPERINTENDENT	1.00	1.00	1.00	0.00
74G21	TREE TRIMMER	2.00	2.00	2.00	0.00
74G22	SENIOR TREE TRIMMER	1.00	1.00	1.00	0.00
74I11	TRAFFIC MAINTENANCE WORKER	4.00	4.00	6.00	2.00
74I25	TRAFFIC MAINTENANCE SUPERINTENDENT	1.00	1.00	1.00	0.00
80A31	SECRETARY	4.00	4.00	4.00	0.00
80A32	SENIOR SECRETARY	2.00	2.00	2.00	0.00
80A33	ADMINISTRATIVE SECRETARY	1.00	1.00	1.00	0.00

Adopted FY 2022-23 to Recommended FY 2023-24 Positions

Classification Code	Classification Label	Adopted Budget 2021-2022	Adopted Budget 2022-2023	Recommended Budget 2023-2024	Change
80E21	OFFICE ASSISTANT II	4.00	4.00	4.00	0.00
80E22	OFFICE ASSISTANT III	1.00	1.00	1.00	0.00
80E90	MAINTENANCE YARD CLERK	4.00	4.00	4.00	0.00
80E91	MAINTENANCE INVENTORY & YARD CLERK	1.00	1.00	1.00	0.00
80J20	ACCOUNTING CLERICAL SUPERVISOR	1.00	1.00	1.00	0.00
80J21	ACCOUNT CLERK	1.00	0.00	0.00	0.00
80J22	SENIOR ACCOUNT CLERK	6.00	9.00	10.00	1.00
80J30	ACCOUNTING TECHNICIAN	3.00	4.00	4.00	0.00
80O22	MAILROOM CLERK	0.00	0.50	0.50	0.00
80O23	SENIOR MAILROOM CLERK	0.00	1.00	1.00	0.00
Total Public Works, Facilities & Parks		197.00	262.50	277.50	15.00
Health					
11A09	DIRECTOR HEALTH SERVICES	1.00	1.00	1.00	0.00
12C05	ASSISTANT DIRECTOR OF HEALTH SERVICES	1.00	1.00	1.00	0.00
12E04	BUREAU CHIEF	5.00	5.00	5.00	0.00
14A10	PROJECT MANAGER I	1.00	1.00	1.00	0.00
14B21	ASSOCIATE PERSONNEL ANALYST	4.00	6.00	6.00	0.00
14B32	SENIOR PERSONNEL ANALYST	2.00	3.00	3.00	0.00
14B66	DEPARTMENTAL HR MANAGER	1.00	1.00	1.00	0.00
14C30	MANAGEMENT ANALYST II	14.50	19.50	24.50	5.00
14C31	MANAGEMENT ANALYST III	13.00	14.00	16.00	2.00
14C48	PUBLIC HEALTH PROGRAM MANAGER II	3.00	3.00	3.00	0.00
14C70	ADMINISTRATIVE SERVICES ASSISTANT	1.00	1.00	1.00	0.00
14C80	PUBLIC HEALTH PROGRAM MANAGER I	2.00	2.00	2.00	0.00
14G02	MANAGEMENT ANALYST I	5.00	4.00	4.00	0.00
14H03	PERSONNEL TECHNICIAN-CONFIDENTIAL	5.00	6.00	6.00	0.00
14H24	EDUCATOR AND VOLUNTEER COORDINATOR	1.00	1.00	1.00	0.00
14H66	OUTPATIENT SERVICES DIRECTOR	1.00	1.00	1.00	0.00
14K32	BEHAVIORAL HEALTH SERVICES MANAGER I	1.00	0.00	0.00	0.00
14K41	BEHAVIORAL HEALTH SERVICES MANAGER II	15.00	16.00	16.00	0.00
14K44	ASSISTANT BUREAU CHIEF	3.00	3.00	4.00	1.00
14K61	ENVIRONMENTAL HEALTH PROGRAM MANAGER	1.00	1.00	1.00	0.00
14N06	OPERATIONS MANAGER	2.00	2.00	2.00	0.00
14N10	OUTPATIENT SERVICES MANAGER I	4.00	4.00	4.00	0.00
14N11	OUTPATIENT SERVICES MANAGER II	4.00	4.00	4.00	0.00
16C87	BUSINESS TECHNOLOGY ANALYST II	1.00	2.00	2.00	0.00
16C88	BUSINESS TECHNOLOGY ANALYST III	2.00	2.00	2.00	0.00
16C93	BUSINESS TECHNOLOGY ANALYST IV	2.00	3.00	3.00	0.00
16F41	DEPARTMENTAL INFORMATION SYSTEMS MANAGER II	1.00	1.00	1.00	0.00
20B10	ACCOUNTANT I	2.00	3.00	3.00	0.00
20B11	ACCOUNTANT II	8.00	8.00	9.00	1.00
20B12	ACCOUNTANT III	6.00	7.00	8.00	1.00
20B93	FINANCE MANAGER II	3.00	4.00	4.00	0.00
20B94	FINANCE MANAGER III	1.00	1.00	1.00	0.00
20B95	FINANCE MANAGER I	3.00	2.00	1.00	(1.00)
25G21	CA CHILDRENS SERVICES CASE WORKER II	3.00	3.00	3.00	0.00
30J01	ENVIRONMENTAL HEALTH TECHNICIAN	0.00	0.00	1.00	1.00
30J21	ENVIRONMENTAL HEALTH SPECIALIST II	25.00	27.00	25.00	(2.00)
30J31	ENVIRONMENTAL HEALTH SPECIALIST III	17.00	17.00	17.00	0.00
30J81	RECYCLING/RESOURCE RECOVERY SPECIALIST	2.00	2.00	2.00	0.00

Adopted FY 2022-23 to Recommended FY 2023-24 Positions

Classification Code	Classification Label	Adopted Budget 2021-2022	Adopted Budget 2022-2023	Recommended Budget 2023-2024	Change
30J84	ENVIRONMENTAL HEALTH SPECIALIST IV	8.00	8.00	8.00	0.00
34C01	ANIMAL CONTROL OFFICER	3.00	5.00	5.00	0.00
34C02	SENIOR ANIMAL CONTROL OFFICER	1.00	1.00	1.00	0.00
34C11	ANIMAL SERVICES SUPERVISOR	2.00	2.00	2.00	0.00
34H24	DEPUTY PUBLIC ADMINISTRATOR/GUARDIAN/CONSERVATOR I	2.50	2.50	2.50	0.00
34H34	DEPUTY PUBLIC ADMINISTRATOR/GUARDIAN/CONSERVATOR II	4.00	4.00	4.00	0.00
43B02	WATER QUALITY SPECIALIST	1.00	1.00	1.00	0.00
43J04	DEPARTMENTAL INFORMATION SYSTEMS SPECIALIST	9.00	9.00	10.00	1.00
43J05	DEPARTMENTAL INFORMATION SYSTEMS COORDINATOR	6.00	6.00	7.00	1.00
43J09	SENIOR DEPARTMENTAL INFORMATION SYSTEMS COORDINATOR	2.00	2.00	2.00	0.00
43J15	SUPERVISING DEPARTMENTAL INFORMATION SYSTEMS COORDINATOR	1.00	2.00	2.00	0.00
50B12	EMERGENCY MEDICAL SERVICES ANALYST	4.00	4.00	4.00	0.00
50C22	PUBLIC HEALTH MICROBIOLOGIST II	3.00	3.00	3.00	0.00
50C23	SENIOR PUBLIC HEALTH MICROBIOLOGIST	1.00	1.00	1.00	0.00
50C70	ASSISTANT DIRECTOR - PUBLIC HEALTH LABORATORY	1.00	1.00	1.00	0.00
50C80	DIRECTOR PUBLIC HEALTH LABORATORY	1.00	1.00	1.00	0.00
50C81	PUBLIC HEALTH CHEMIST	1.00	1.00	1.00	0.00
50E23	LABORATORY ASSISTANT	3.00	3.00	3.00	0.00
50F20	OCCUPATIONAL THERAPIST	1.00	1.00	1.00	0.00
50F23	OCCUPATIONAL THERAPIST-PHYSICALLY HANDICAPPED CHILDREN	3.40	3.40	3.40	0.00
50G23	PHYSICAL THERAPIST-PHYSICALLY HANDICAPPED CHILDREN	3.65	3.65	3.65	0.00
50G25	SENIOR THERAPIST-PHYSICALLY HANDICAPPED CHILDREN	0.80	0.80	1.80	1.00
50G31	SUPERVISING THERAPIST-MED THER PROG	1.00	1.00	1.00	0.00
50J01	CHRONIC DISEASE PREVENTION SPECIALIST I	24.00	24.00	24.00	0.00
50J11	CHRONIC DISEASE PREVENTION SPECIALIST II	9.00	10.00	13.00	3.00
50J21	CHRONIC DISEASE PREVENTION COORDINATOR	12.00	14.00	16.00	2.00
50K18	HEALTH PROGRAM COORDINATOR	6.00	6.00	5.00	(1.00)
50K19	HEALTH EDUCATION ASSISTANT	7.00	7.00	14.00	7.00
50K22	HEALTH EDUCATOR	1.00	1.00	0.00	(1.00)
50K23	SENIOR HEALTH EDUCATOR	2.00	2.00	1.00	(1.00)
50L22	PUBLIC HEALTH NUTRITIONIST II	3.00	3.00	4.00	1.00
50L80	SUPERVISING PUBLIC HEALTH NUTRITIONIST	3.00	3.00	3.00	0.00
50M21	REGISTERED VETERINARY TECHNICIAN	1.00	1.00	1.50	0.50
50M80	VETERINARIAN	1.00	1.00	1.50	0.50
50N11	PUBLIC HEALTH EPIDEMIOLOGIST II	5.00	4.00	5.00	1.00
50N22	SUPERVISING PUBLIC HEALTH EPIDEMIOLOGIST	1.00	2.00	2.00	0.00
50T01	MEDICAL RECORD TECHNICIAN I	1.00	1.00	2.00	1.00
50U16	BEHAVIORAL HEALTH AIDE	20.03	25.10	25.10	0.00
50U42	MEDICAL ASSISTANT	157.00	168.00	176.00	8.00
52A21	CLINIC NURSE	1.00	1.00	1.00	0.00
52A22	SENIOR CLINIC NURSE	9.00	10.00	9.00	(1.00)
52A83	SUPERVISING CLINIC NURSE	0.00	0.00	1.00	1.00
52A94	PSYCHIATRIC NURSE PRACTITIONER	3.00	3.00	3.00	0.00
52A97	CLINIC NURSE PRACTITIONER	9.00	9.00	9.00	0.00
52E01	PUBLIC HEALTH LICENSED VOCATIONAL NURSE	8.00	21.00	21.00	0.00
52E20	DIRECTOR OF PUBLIC HEALTH NURSING	1.00	1.00	1.00	0.00
52E22	PUBLIC HEALTH NURSE II	23.00	23.00	26.00	3.00
52E23	PUBLIC HEALTH NURSE III	3.00	3.00	3.00	0.00
52E80	SUPERVISING PUBLIC HEALTH NURSE	6.75	9.75	9.75	0.00
54B04	GENERAL INTERNIST	2.00	2.00	2.00	0.00

Adopted FY 2022-23 to Recommended FY 2023-24 Positions

Classification Code	Classification Label	Adopted Budget 2021-2022	Adopted Budget 2022-2023	Recommended Budget 2023-2024	Change
54B12	CONTRACT PHYSICIAN	44.60	44.60	45.60	1.00
54B13	CLINIC SERVICES MEDICAL DIRECTOR	1.00	1.00	1.00	0.00
54B90	CLINIC PHYSICIAN II	5.00	5.00	4.00	(1.00)
54C03	CLINIC PHYSICIAN ASSISTANT	9.00	9.00	9.00	0.00
54C05	PSYCHIATRIC PHYSICIAN ASSISTANT	2.00	2.00	2.00	0.00
60A21	CLINICAL PSYCHOLOGIST	14.50	12.50	12.00	(0.50)
60B21	PSYCHIATRIC SOCIAL WORKER II	201.00	198.00	186.00	(12.00)
60B23	BEHAVIORAL HEALTH UNIT SUPERVISOR	30.00	35.00	35.00	0.00
60B25	SENIOR PSYCHIATRIC SOCIAL WORKER	23.00	26.00	36.00	10.00
60C21	SOCIAL WORKER II	0.00	1.00	1.00	0.00
60C22	SOCIAL WORKER III	39.00	55.00	60.00	5.00
60C80	SOCIAL WORK SUPERVISOR I	0.00	1.00	1.00	0.00
60I10	DEPUTY DIRECTOR BEHAVIORAL HEALTH	3.00	5.00	4.00	(1.00)
60L01	PATIENT RIGHTS ADVOCATE	1.00	1.00	1.00	0.00
60P21	COMMUNITY SERVICE AIDE II	3.00	26.00	27.00	1.00
60P22	COMMUNITY SERVICE AIDE III	5.00	5.00	7.00	2.00
60P23	COMMUNITY SERVICE AIDE IV	3.00	3.00	4.00	1.00
60V11	BEHAVIORAL HEALTH GROUP COUNSELOR II	2.00	1.00	0.00	(1.00)
70B03	ANIMAL CARE TECHNICIAN II	6.00	7.00	7.00	0.00
70B04	SENIOR ANIMAL CARE TECHNICIAN	1.00	1.00	1.00	0.00
72A23	BUILDING MAINTENANCE WORKER	1.00	1.00	1.00	0.00
72A81	BUILDING MAINTENANCE SUPERVISOR	0.00	0.00	1.00	1.00
80A31	SECRETARY	1.00	1.00	1.00	0.00
80A32	SENIOR SECRETARY	4.00	4.00	4.00	0.00
80A99	ADMINISTRATIVE SECRETARY-CONFIDENTIAL	1.00	1.00	1.00	0.00
80E01	OFFICE ASSISTANT I	1.00	2.00	2.00	0.00
80E21	OFFICE ASSISTANT II	9.00	11.00	11.00	0.00
80E22	OFFICE ASSISTANT III	19.00	20.00	24.00	4.00
80E80	PRINCIPAL OFFICE ASSISTANT	4.00	5.00	5.00	0.00
80E82	SUPERVISING OFFICE ASSISTANT II	1.00	1.00	1.00	0.00
80E93	SUPERVISING VITAL RECORDS SPECIALIST	1.00	1.00	1.00	0.00
80J20	ACCOUNTING CLERICAL SUPERVISOR	0.00	0.00	1.00	1.00
80J22	SENIOR ACCOUNT CLERK	6.00	6.00	6.00	0.00
80J30	ACCOUNTING TECHNICIAN	7.00	9.00	12.00	3.00
80K20	CLINIC OFFICE SUPERVISOR	2.00	0.00	0.00	0.00
80K25	CLINIC OPERATIONS SUPERVISOR	7.00	8.00	11.00	3.00
80L02	PATIENT SERVICES REPRESENTATIVE II	74.00	76.00	81.00	5.00
80L03	SENIOR PATIENT SERVICES REPRESENTATIVE	1.00	1.00	1.00	0.00
80L04	SUPERVISING PATIENT SERVICES REPRESENTATIVE	3.00	5.00	5.00	0.00
80M02	PATIENT ACCOUNT REPRESENTATIVE II	18.00	17.00	16.00	(1.00)
80M03	SENIOR PATIENT ACCOUNT REPRESENTATIVE	0.00	1.00	2.00	1.00
80M04	SUPERVISING PATIENT ACCOUNT REPRESENTATIVE	2.00	2.00	2.00	0.00
80U21	TELEPHONE OPERATOR	1.00	1.00	1.00	0.00
Total Health		1,104.73	1,214.80	1,271.30	56.50
Social Services					
11A12	DIRECTOR OF SOCIAL SERVICES	1.00	1.00	1.00	0.00
12C13	ASSISTANT DIRECTOR SOCIAL SERVICES	1.00	1.00	1.00	0.00
14B21	ASSOCIATE PERSONNEL ANALYST	4.00	4.00	4.00	0.00
14B32	SENIOR PERSONNEL ANALYST	1.00	2.00	2.00	0.00
14B51	DEPARTMENTAL HR MANAGER-MERIT SYSTEMS	1.00	1.00	1.00	0.00

Adopted FY 2022-23 to Recommended FY 2023-24 Positions

Classification Code	Classification Label	Adopted Budget 2021-2022	Adopted Budget 2022-2023	Recommended Budget 2023-2024	Change
14C30	MANAGEMENT ANALYST II	18.00	20.00	20.00	0.00
14C31	MANAGEMENT ANALYST III	15.00	16.00	17.00	1.00
14C70	ADMINISTRATIVE SERVICES ASSISTANT	8.00	8.00	8.00	0.00
14C72	ADMINISTRATIVE SERVICES MANAGER	1.00	1.00	1.00	0.00
14G02	MANAGEMENT ANALYST I	1.00	1.00	1.00	0.00
14H03	PERSONNEL TECHNICIAN-CONFIDENTIAL	4.00	5.00	5.00	0.00
14H70	STAFF TRAINER II	12.00	12.00	12.00	0.00
14N05	ADMINISTRATIVE OPERATIONS MANAGER	1.00	1.00	1.00	0.00
16C87	BUSINESS TECHNOLOGY ANALYST II	5.00	5.00	5.00	0.00
16C88	BUSINESS TECHNOLOGY ANALYST III	1.00	1.00	2.00	1.00
16C93	BUSINESS TECHNOLOGY ANALYST IV	1.00	2.00	2.00	0.00
16F40	DEPARTMENTAL INFORMATION SYSTEMS MANAGER I	1.00	1.00	1.00	0.00
16F41	DEPARTMENTAL INFORMATION SYSTEMS MANAGER II	1.00	1.00	1.00	0.00
20B10	ACCOUNTANT I	2.00	3.00	3.00	0.00
20B11	ACCOUNTANT II	4.00	5.00	5.00	0.00
20B12	ACCOUNTANT III	1.00	1.00	1.00	0.00
20B93	FINANCE MANAGER II	2.00	2.00	2.00	0.00
20B94	FINANCE MANAGER III	1.00	1.00	1.00	0.00
20B95	FINANCE MANAGER I	0.00	0.00	1.00	1.00
25E21	ELIGIBILITY SPECIALIST II	168.00	182.00	182.00	0.00
25E22	ELIGIBILITY SPECIALIST III	107.00	111.00	111.00	0.00
25E80	ELIGIBILITY SUPERVISOR	38.00	40.00	40.00	0.00
43J05	DEPARTMENTAL INFORMATION SYSTEMS COORDINATOR	3.00	3.00	5.00	2.00
43J09	SENIOR DEPARTMENTAL INFORMATION SYSTEMS COORDINATOR	6.00	6.00	6.00	0.00
43J15	SUPERVISING DEPARTMENTAL INFORMATION SYSTEMS COORDINATOR	2.00	2.00	2.00	0.00
52E22	PUBLIC HEALTH NURSE II	3.00	3.00	2.00	(1.00)
60C22	SOCIAL WORKER III	40.00	40.00	40.00	0.00
60C24	SOCIAL WORKER V	81.00	92.00	92.00	0.00
60C80	SOCIAL WORK SUPERVISOR I	8.00	8.00	8.00	0.00
60C81	SOCIAL WORK SUPERVISOR II	17.00	19.00	19.00	0.00
60D10	SOCIAL SERVICES AIDE I	2.00	2.00	2.00	0.00
60D11	SOCIAL SERVICES AIDE II	66.00	66.00	66.00	0.00
60H11	EMPLOYMENT & TRAINING WORKER II	2.00	1.00	1.00	0.00
60H21	EMPLOYMENT & TRAINING WORKER III	33.00	32.00	32.00	0.00
60H31	EMPLOYMENT & TRAINING SUPERVISOR	7.00	7.00	7.00	0.00
60H32	SUPERVISING STAFF TRAINER	1.00	1.00	1.00	0.00
60I01	DEPUTY DIRECTOR SOCIAL SERVICES	4.00	4.00	4.00	0.00
60I02	PROGRAM MANAGER II	14.00	14.00	15.00	1.00
60U11	MILITARY & VETERANS REPRESENTATIVE II	2.00	2.00	2.00	0.00
60U20	MILITARY & VETERAN AFFAIRS OFFICER	1.00	1.00	1.00	0.00
60U21	MILITARY & VETERANS REPRESENTATIVE III	4.00	4.00	4.00	0.00
60X01	COMMUNITY AFFILIATION MANAGER	1.00	1.00	2.00	1.00
70A21	CUSTODIAN	1.00	1.00	1.00	0.00
70F21	COURIER	1.00	1.00	1.00	0.00
70F23	STOREKEEPER	0.00	2.00	2.00	0.00
70F79	WAREHOUSE WORKER	2.00	0.00	0.00	0.00
70F81	SUPERVISING STOREKEEPER	0.00	1.00	1.00	0.00
70F82	SUPERVISING WAREHOUSE WORKER	1.00	0.00	0.00	0.00
70N01	OFFICE MAINTENANCE WORKER	2.00	3.00	3.00	0.00
80A31	SECRETARY	13.00	13.00	13.00	0.00

Adopted FY 2022-23 to Recommended FY 2023-24 Positions

Classification Code	Classification Label	Adopted Budget 2021-2022	Adopted Budget 2022-2023	Recommended Budget 2023-2024	Change
80A32	SENIOR SECRETARY	6.00	6.00	5.00	(1.00)
80A99	ADMINISTRATIVE SECRETARY-CONFIDENTIAL	1.00	1.00	1.00	0.00
80E21	OFFICE ASSISTANT II	82.00	81.00	81.00	0.00
80E22	OFFICE ASSISTANT III	36.00	36.00	36.00	0.00
80E80	PRINCIPAL OFFICE ASSISTANT	13.00	13.00	13.00	0.00
80E81	SUPERVISING OFFICE ASSISTANT I	17.00	17.00	17.00	0.00
80E82	SUPERVISING OFFICE ASSISTANT II	2.00	2.00	2.00	0.00
80E98	PRINCIPAL CLERK-CONFIDENTIAL	2.00	0.00	0.00	0.00
80J20	ACCOUNTING CLERICAL SUPERVISOR	1.00	1.00	1.00	0.00
80J22	SENIOR ACCOUNT CLERK	2.00	1.00	0.00	(1.00)
80J30	ACCOUNTING TECHNICIAN	3.00	4.00	6.00	2.00
Total Social Services		882.00	919.00	925.00	6.00
Library					
11A05	LIBRARY DIRECTOR	1.00	1.00	1.00	0.00
12C04	ASSISTANT LIBRARY DIRECTOR	1.00	1.00	1.00	0.00
14C71	ADMINISTRATIVE SERVICES OFFICER	1.00	1.00	1.00	0.00
43J05	DEPARTMENTAL INFORMATION SYSTEMS COORDINATOR	1.00	1.00	1.00	0.00
65A31	LIBRARIAN I	1.00	1.50	1.50	0.00
65A33	LIBRARIAN II	12.00	9.00	10.00	1.00
65A40	LIBRARIAN III	3.00	4.00	4.00	0.00
65A85	MANAGING LIBRARIAN	2.00	2.00	2.00	0.00
80C01	LIBRARY ASSISTANT I	6.00	5.00	5.00	0.00
80C21	LIBRARY ASSISTANT II	25.00	27.00	27.00	0.00
80C22	LIBRARY ASSISTANT III	11.00	11.00	11.00	0.00
80J21	ACCOUNT CLERK	1.00	1.00	1.00	0.00
80J22	SENIOR ACCOUNT CLERK	1.00	1.00	1.00	0.00
Total Library		66.00	65.50	66.50	1.00
Cooperative Extension Service					
14C70	ADMINISTRATIVE SERVICES ASSISTANT	1.00	1.00	1.00	0.00
80A31	SECRETARY	1.00	1.00	1.00	0.00
80J30	ACCOUNTING TECHNICIAN	1.00	1.00	1.00	0.00
Total Cooperative Extension Service		3.00	3.00	3.00	0.00
Natividad Medical Center					
11A25	HOSPITAL CHIEF EXECUTIVE OFFICER	1.00	1.00	1.00	0.00
12C28	HOSPITAL CHIEF NURSING OFFICER	1.00	1.00	1.00	0.00
12C29	HOSPITAL ASSISTANT ADMINISTRATOR	4.00	3.00	3.00	0.00
14A10	PROJECT MANAGER I	1.00	1.00	1.00	0.00
14A12	PROJECT MANAGER III	1.00	1.00	1.00	0.00
14A70	HOSPITAL REVENUE CYCLE EXAMINER	2.00	2.00	2.00	0.00
14A80	HOSPITAL DECISION SUPPORT MANAGER	1.00	1.00	1.00	0.00
14B01	PERSONNEL ANALYST	0.00	4.00	4.00	0.00
14B21	ASSOCIATE PERSONNEL ANALYST	1.00	1.00	1.00	0.00
14B28	SUPERVISING PERSONNEL ANALYST	1.00	1.00	1.00	0.00
14B32	SENIOR PERSONNEL ANALYST	3.00	3.00	3.00	0.00
14B66	DEPARTMENTAL HR MANAGER	1.00	1.00	1.00	0.00
14C30	MANAGEMENT ANALYST II	8.00	11.00	12.00	1.00
14C31	MANAGEMENT ANALYST III	5.00	5.00	5.00	0.00
14C36	HOSPITAL DECISION SUPPORT ANALYST	2.00	2.00	1.00	(1.00)
14C52	PATIENT FINANCIAL SERVICES DIRECTOR	2.00	3.00	3.00	0.00
14C60	HOSPITAL CHIEF FINANCIAL OFFICER	1.00	1.00	1.00	0.00

Adopted FY 2022-23 to Recommended FY 2023-24 Positions

Classification Code	Classification Label	Adopted Budget 2021-2022	Adopted Budget 2022-2023	Recommended Budget 2023-2024	Change
14C70	ADMINISTRATIVE SERVICES ASSISTANT	2.00	2.00	2.00	0.00
14E20	BUYER II	5.00	6.00	6.00	0.00
14E90	DIRECTOR OF MATERIAL MANAGEMENT	1.00	1.00	1.00	0.00
14G02	MANAGEMENT ANALYST I	5.00	3.00	1.00	(2.00)
14H03	PERSONNEL TECHNICIAN-CONFIDENTIAL	6.00	3.00	3.00	0.00
14H24	EDUCATOR AND VOLUNTEER COORDINATOR	1.00	1.00	1.00	0.00
14H60	DIRECTOR OF MARKETING AND COMMUNITY RELATIONS	1.00	1.00	1.00	0.00
14H65	MEDICAL STAFF COORDINATOR	1.00	1.00	1.00	0.00
14K26	MANAGED CARE OPERATIONS MANAGER	1.00	1.00	1.00	0.00
14K31	MANAGER OF DIAGNOSTIC IMAGING SERVICES	1.00	1.00	1.00	0.00
14K32	BEHAVIORAL HEALTH SERVICES MANAGER I	1.50	1.50	1.50	0.00
14K33	HOSP DIRECTOR OF ENGINEERING AND SAFETY	1.00	1.00	1.00	0.00
14K35	NMC HUMAN RESOURCES ADMINISTRATOR	1.00	1.00	1.00	0.00
14K43	HOSPITAL CHIEF INFORMATION OFFICER	1.00	1.00	1.00	0.00
14K67	HOSPITAL PURCHASING & MATERIALS SUPPORT DIRECTOR	1.00	1.00	1.00	0.00
14K72	HOSPITAL CHIEF MEDICAL INFORMATION OFFICER	0.00	0.00	1.00	1.00
14M02	HOSPITAL INTERPRETER SERVICES MANAGER	1.00	1.00	1.00	0.00
14M30	TRAUMA PROGRAM MANAGER	0.00	0.00	1.00	1.00
14M31	HOSPITAL DIRECTOR OF NURSING EDUCATION	1.00	1.00	1.00	0.00
14M32	HOSPITAL RISK ASSESSMENT AND COMPLIANCE OFFICER	1.00	1.00	0.00	(1.00)
14M43	HOSPITAL PATIENT SAFETY MANAGER	0.00	0.00	1.00	1.00
14M44	HOSPITAL COMPLIANCE OFFICER	0.00	0.00	1.00	1.00
14N11	OUTPATIENT SERVICES MANAGER II	1.00	3.00	3.00	0.00
14N30	HOSPITAL PATIENT ADMITTING MANAGER	1.00	1.00	1.00	0.00
14N31	HOSPITAL DIRECTOR OF ENVIRONMENTAL SERVICES	1.00	1.00	1.00	0.00
14P10	DIRECTOR OF MEDICAL CENTER PHYSICIAN SERVICES	1.00	1.00	1.00	0.00
16C55	INFORMATION TECHNOLOGY SYSTEMS ANALYST III	2.00	2.00	2.00	0.00
16C60	HOSPITAL SOFTWARE ANALYST I	1.00	0.00	0.00	0.00
16C61	HOSPITAL SOFTWARE ANALYST II	5.00	5.00	4.00	(1.00)
16C62	HOSPITAL SOFTWARE ANALYST III	10.00	10.00	10.00	0.00
16E50	HOSPITAL SECURITY & DATABASE ADMINISTRATOR	3.00	3.00	2.00	(1.00)
20B12	ACCOUNTANT III	2.00	2.00	2.00	0.00
20B91	CHIEF HOSPITAL ACCOUNTANT	1.00	1.00	1.00	0.00
20B92	HOSPITAL CONTROLLER	1.00	1.00	1.00	0.00
20B94	FINANCE MANAGER III	1.00	1.00	1.00	0.00
20B95	FINANCE MANAGER I	1.00	1.00	1.00	0.00
41K01	HOSPITAL NETWORK & SYSTEMS ENGINEER	2.00	2.00	2.00	0.00
43G01	INFORMATION TECHNOLOGY MANAGER	3.00	3.00	2.00	(1.00)
43G04	INFORMATION TECHNOLOGY PROJECT MANAGER III	2.00	2.00	2.00	0.00
43J05	DEPARTMENTAL INFORMATION SYSTEMS COORDINATOR	1.00	1.00	1.00	0.00
43M40	HOSPITAL INFORMATION SYSTEMS SUPPORT TECHNICIAN	4.00	4.00	4.00	0.00
50A21	PHARMACIST I	12.20	12.20	12.20	0.00
50A23	PHARMACY DIRECTOR	1.00	1.00	1.00	0.00
50A25	CLINICAL PHARMACY COORDINATOR	2.00	2.00	2.00	0.00
50D11	MEDICAL LABORATORY TECHNICIAN	1.60	1.80	1.80	0.00
50D12	CLINICAL LABORATORY ASSISTANT	17.90	17.90	17.90	0.00
50D13	SENIOR CLINICAL LABORATORY ASSISTANT	2.00	2.00	2.00	0.00
50D21	CLINICAL LABORATORY SCIENTIST	15.00	15.00	15.00	0.00
50D22	SENIOR CLINICAL LABORATORY SCIENTIST	9.00	9.00	9.00	0.00
50D23	SUPERVISING CLINICAL LABORATORY SCIENTIST	1.00	2.00	2.00	0.00
50D80	CLINICAL LABORATORY MANAGER	1.00	1.00	1.00	0.00

Adopted FY 2022-23 to Recommended FY 2023-24 Positions

Classification Code	Classification Label	Adopted Budget 2021-2022	Adopted Budget 2022-2023	Recommended Budget 2023-2024	Change
50F10	SUPERVISING THERAPIST	2.00	2.00	2.00	0.00
50F20	OCCUPATIONAL THERAPIST	11.20	11.40	11.40	0.00
50G11	PHYSICAL THERAPIST	13.80	13.80	13.80	0.00
50G41	SPEECH PATHOLOGIST	6.00	6.00	6.00	0.00
50G95	REHABILITATIVE SERVICES MANAGER	1.00	1.00	1.00	0.00
50K19	HEALTH EDUCATION ASSISTANT	4.00	4.00	5.00	1.00
50K23	SENIOR HEALTH EDUCATOR	0.00	0.00	1.00	1.00
50P21	RESPIRATORY CARE PRACTITIONER	19.30	22.90	22.00	(0.90)
50P22	SENIOR RESPIRATORY CARE PRACTITIONER	1.00	1.00	1.00	0.00
50P24	SUPERVISING RESPIRATORY CARE PRACTITIONER	1.00	1.00	1.00	0.00
50P80	DIRECTOR OF RESPIRATORY CARE SERVICES	1.00	1.00	1.00	0.00
50R18	INTERVENTIONAL RADIOLOGIC TECHNOLOGIST	0.00	0.00	4.90	4.90
50R20	SENIOR INTERVENTIONAL RADIOLOGIC TECHNOLOGIST	0.00	0.00	1.00	1.00
50R21	RADIOLOGIC TECHNOLOGIST	26.30	27.00	21.40	(5.60)
50R22	SENIOR RADIOLOGIC TECHNOLOGIST	5.00	5.00	5.00	0.00
50R25	DIAGNOSTIC IMAGING SUPERVISOR	2.00	2.00	2.00	0.00
50R31	SONOGRAPHER	8.60	8.60	5.60	(3.00)
50R32	SENIOR SONOGRAPHER	1.00	1.00	1.00	0.00
50R35	CARDIAC SONOGRAPHER	0.00	0.00	3.00	3.00
50R41	NUCLEAR MEDICINE TECHNOLOGIST	1.00	1.00	1.00	0.00
50T03	HEALTH INFORMATION MANAGEMENT CODER II	7.00	7.00	8.00	1.00
50T22	HEALTH INFORMATION MANAGEMENT CODING SUPERVISOR	1.00	1.00	1.00	0.00
50T33	HEALTH INFORMATION MANAGEMENT DATA INTEGRITY EXAMINER	1.00	0.00	0.00	0.00
50T41	DIRECTOR OF HEALTH INFORMATION MANAGEMENT	1.00	1.00	1.00	0.00
50U17	PHYSICAL THERAPIST ASSISTANT	6.00	6.00	6.00	0.00
50U18	PHARMACY TECHNICIAN	11.40	13.30	14.10	0.80
50U20	NURSING ASSISTANT	125.80	106.60	106.80	0.20
50U22	HEALTH CARE TECHNICIAN	3.70	1.60	0.70	(0.90)
50U23	OBSTETRICAL TECHNICIAN	6.30	6.30	6.30	0.00
50U25	ORTHOPEDIC TECHNICIAN	1.00	1.00	2.00	1.00
50U26	SENIOR OBSTETRICAL TECHNICIAN	0.90	0.90	0.90	0.00
50U27	SURGICAL TECHNICIAN	11.60	11.60	11.60	0.00
50U28	SENIOR PHARMACY TECHNICIAN	2.00	2.00	2.00	0.00
50U29	ENDOSCOPY TECHNICIAN	1.90	1.90	1.90	0.00
50U30	DIETITIAN AIDE	8.50	8.50	6.00	(2.50)
50U31	ANESTHESIA TECHNICIAN	0.00	1.80	1.80	0.00
50U42	MEDICAL ASSISTANT	2.00	2.00	3.70	1.70
50U43	CENTRAL STERILE TECHNICIAN	5.80	5.80	5.80	0.00
50U44	SENIOR CENTRAL STERILE TECHNICIAN	1.00	1.00	1.00	0.00
50U51	TELEMETRY TECHNICIAN	4.70	4.70	4.70	0.00
50Y21	DIETITIAN	5.40	5.40	5.40	0.00
50Y31	SUPERVISING DIETITIAN	1.00	1.00	1.00	0.00
52A02	LICENSED VOCATIONAL NURSE	11.30	11.30	10.80	(0.50)
52A16	SUPERVISING NURSE I	15.40	15.40	15.40	0.00
52A17	SUPERVISING NURSE II	1.90	1.90	1.90	0.00
52A19	STAFF NURSE II	369.95	368.05	385.15	17.10
52A20	STAFF NURSE III	36.60	37.40	37.40	0.00
52A21	CLINIC NURSE	4.00	3.00	3.00	0.00
52A22	SENIOR CLINIC NURSE	8.60	13.60	13.60	0.00
52A31	INFECTION CONTROL NURSE	2.00	2.00	2.00	0.00
52A33	CASE MANAGEMENT NURSE	15.00	15.00	13.50	(1.50)

Adopted FY 2022-23 to Recommended FY 2023-24 Positions

Classification Code	Classification Label	Adopted Budget 2021-2022	Adopted Budget 2022-2023	Recommended Budget 2023-2024	Change
52A34	UTILIZATION MANAGEMENT COORDINATOR	2.00	2.00	2.00	0.00
52A40	HOSPITAL NURSE AUDITOR	2.00	0.00	0.00	0.00
52A50	HOSPITAL QUALITY ASSURANCE NURSE	6.90	8.90	8.40	(0.50)
52A60	CLINICAL NURSE SPECIALIST	4.00	4.00	4.00	0.00
52A83	SUPERVISING CLINIC NURSE	2.00	2.00	2.00	0.00
52A84	QUALITY/COMPLIANCE ADMINISTRATOR	1.00	1.00	1.00	0.00
52A88	NURSING SERVICES DIVISION MANAGER	5.00	6.00	6.00	0.00
52A89	ADMIN NURSE/HOUSE SUPV	6.30	6.30	6.30	0.00
52A92	NURSING SERVICES UNIT MANAGER	3.00	3.00	2.00	(1.00)
52A96	DIRECTOR OF SURGICAL SERVICES	1.00	1.00	1.00	0.00
52A97	CLINIC NURSE PRACTITIONER	2.40	2.40	2.00	(0.40)
52A98	HOSPITAL NURSE PRACTITIONER	12.50	12.80	12.50	(0.30)
54A03	RESIDENT PHYSICIAN III	33.00	33.00	33.00	0.00
54B10	CHIEF OB/GYN SURGEON	1.00	1.00	1.00	0.00
54B12	CONTRACT PHYSICIAN	49.00	61.00	59.50	(1.50)
54B15	NEUROSURGEON	1.00	1.00	1.00	0.00
54B16	TRAUMA SURGEON	3.00	3.00	3.00	0.00
54B17	VASCULAR SURGEON	1.00	1.00	1.00	0.00
54B70	HOSPITAL CHIEF MEDICAL OFFICER	2.00	2.00	2.00	0.00
54B82	CHIEF OF SURGERY	1.00	1.00	1.00	0.00
54B92	ASSISTANT DIRECTOR FAMILY PRACTICE RESIDENCY PROGRAM	1.00	1.00	1.00	0.00
54C03	CLINIC PHYSICIAN ASSISTANT	3.00	2.00	1.00	(1.00)
60B21	PSYCHIATRIC SOCIAL WORKER II	0.00	5.90	6.90	1.00
60C24	SOCIAL WORKER V	11.00	6.00	6.00	0.00
60C81	SOCIAL WORK SUPERVISOR II	1.00	2.00	2.00	0.00
65A22	MEDICAL LIBRARIAN	1.00	1.00	0.00	(1.00)
70A10	HOSPITAL ENVIRONMENTAL SERVICES AIDE	60.70	59.90	59.90	0.00
70A12	HOSPITAL SENIOR ENVIRONMENTAL SERVICES AIDE	3.00	3.80	3.80	0.00
70A13	HOSPITAL SUPERVISING ENVIRONMENTAL SERVICES AIDE	2.00	2.00	2.00	0.00
70C21	GROUNDSKEEPER	1.00	1.00	1.00	0.00
70F21	COURIER	1.00	1.00	1.00	0.00
70F23	STOREKEEPER	14.00	16.00	13.00	(3.00)
70F81	SUPERVISING STOREKEEPER	1.00	2.00	2.00	0.00
70K21	FOOD SERVICE WORKER II	18.50	18.50	18.50	0.00
70K23	COOK	4.50	5.00	5.00	0.00
70K25	SENIOR COOK	2.00	2.00	2.00	0.00
70K80	HEAD COOK	2.00	2.00	2.00	0.00
70K84	HOSPITAL DIRECTOR OF FOOD SERVICES	1.00	1.00	1.00	0.00
70M02	PATIENT TRANSPORTER	6.00	6.00	6.00	0.00
72A23	BUILDING MAINTENANCE WORKER	1.00	1.00	1.00	0.00
72A24	MAINTENANCE PAINTER	2.00	2.00	2.00	0.00
72A80	HOSPITAL MAINTENANCE SUPERVISOR	1.00	1.00	1.00	0.00
72A87	PHYSICAL PLANT MANAGER	1.00	1.00	1.00	0.00
72C19	HOSPITAL MAINTENANCE MECHANIC	9.00	9.00	9.00	0.00
80A32	SENIOR SECRETARY	5.00	6.00	6.00	0.00
80A33	ADMINISTRATIVE SECRETARY	2.00	2.00	2.00	0.00
80A34	SENIOR SECRETARY-CONFIDENTIAL	1.00	1.00	1.00	0.00
80A99	ADMINISTRATIVE SECRETARY-CONFIDENTIAL	3.00	4.00	3.00	(1.00)
80E21	OFFICE ASSISTANT II	8.50	7.50	7.00	(0.50)
80E22	OFFICE ASSISTANT III	17.30	17.30	16.30	(1.00)
80E80	PRINCIPAL OFFICE ASSISTANT	15.25	15.25	17.25	2.00

Adopted FY 2022-23 to Recommended FY 2023-24 Positions

Classification Code	Classification Label	Adopted Budget 2021-2022	Adopted Budget 2022-2023	Recommended Budget 2023-2024	Change
80E81	SUPERVISING OFFICE ASSISTANT I	1.00	1.00	1.00	0.00
80E82	SUPERVISING OFFICE ASSISTANT II	2.00	2.00	2.00	0.00
80G21	DATA ENTRY OPERATOR II	1.00	1.00	1.00	0.00
80J19	CASHIER	1.50	1.00	1.00	0.00
80J20	ACCOUNTING CLERICAL SUPERVISOR	1.00	1.00	1.00	0.00
80J22	SENIOR ACCOUNT CLERK	4.00	4.00	4.00	0.00
80J30	ACCOUNTING TECHNICIAN	3.00	3.00	4.00	1.00
80K21	MEDICAL UNIT CLERK	20.10	28.60	29.60	1.00
80K23	HOSPITAL MEDICAL INTERPRETER	8.00	10.00	9.00	(1.00)
80L01	PATIENT SERVICES REPRESENTATIVE I	0.00	0.60	0.60	0.00
80L02	PATIENT SERVICES REPRESENTATIVE II	54.70	61.70	58.10	(3.60)
80L03	SENIOR PATIENT SERVICES REPRESENTATIVE	3.00	4.00	4.00	0.00
80L04	SUPERVISING PATIENT SERVICES REPRESENTATIVE	3.00	3.00	4.00	1.00
80M02	PATIENT ACCOUNT REPRESENTATIVE II	30.30	30.30	30.40	0.10
80M03	SENIOR PATIENT ACCOUNT REPRESENTATIVE	3.00	3.00	3.00	0.00
80M05	PATIENT ACCOUNT MANAGER	2.00	2.00	2.00	0.00
80U11	HOSPITAL COMMUNICATIONS OPERATOR II	6.80	7.00	7.00	0.00
80U14	HOSPITAL SUPERVISING COMMUNICATIONS OPERATOR	1.00	1.00	1.00	0.00
Total Natividad Medical Center		1,435.40	1,466.90	1,473.00	6.10
Grand Total		5,516.63	5,737.20	5,841.30	104.10



This page intentionally left blank.

Board of Supervisors

General Overview:

Monterey County is governed by five supervisors elected by district to represent the distinct needs of individual districts as well as the County in its entirety. District One, represented by Supervisor Luis A. Alejo, encompasses the urban east, west, north, and downtown areas of the City of Salinas. District Two, an area spanning from Boronda north through Castroville and Pajaro to the Santa Cruz County line, is represented by Supervisor Glenn Church. Supervisor Chris Lopez represents District Three, which includes a small part of east Salinas, the four Salinas Valley cities of Gonzales, Greenfield, Soledad, and King City, and south to the San Luis Obispo County line. District Four, represented by Supervisor Wendy Root Askew, includes south Salinas, Fort Ord, and the cities of Marina, Seaside, Del Rey Oaks, and Sand City. Supervisor Mary Adams represents District Five, covering the Highway 68 corridor, Carmel Valley and Pebble Beach, the cities of Carmel-by-the-Sea, Monterey, and Pacific Grove, and south along the Big Sur coastline.

Program and Functions:

The Board of Supervisors is responsible for establishing and directing the implementation of policies consistent with public needs and the requirements of State and federal laws. As the governing body of Monterey County, the Board of Supervisors also acts in the capacity of the Board of Directors of the Monterey County Water Resources Agency and as the governing Board of the Successor Agency and Housing Successor Agency of the County Redevelopment Agency. Board members provide review and policy guidance through committees of the Board of Supervisors, including the Budget, Health, Housing & Human Services, Capital Improvement, Legislative, Human Resources, Economic Development, and Alternative Energy and the Environment Committees. Additionally, Board members represent the interests of Monterey County as members of numerous local and regional committees, boards, and special districts. District Offices coordinate Board business through the Clerk of the Board and the County Administrative Office. The Board of Supervisors' budget provides for the payment of salaries and benefits to Board members and their staff, as well as costs for countywide internal services, such as information technology, telecommunications, general liability insurance, and workers' compensation insurance. Appropriations also provide for expenses related to the business needs of each district, including office supplies, equipment and maintenance, and travel requirements.

Contributions to Monterey County's Strategic Initiatives:

The Board of Supervisors develops and adopts the Strategic Initiatives setting forth policies, key objectives, and performance measures for Economic Development, Administration, Health and Human Services, Infrastructure, and Public Safety.



Operating Budget: \$4,958,011
Positions (FTEs): 20.00

Board of Supervisors

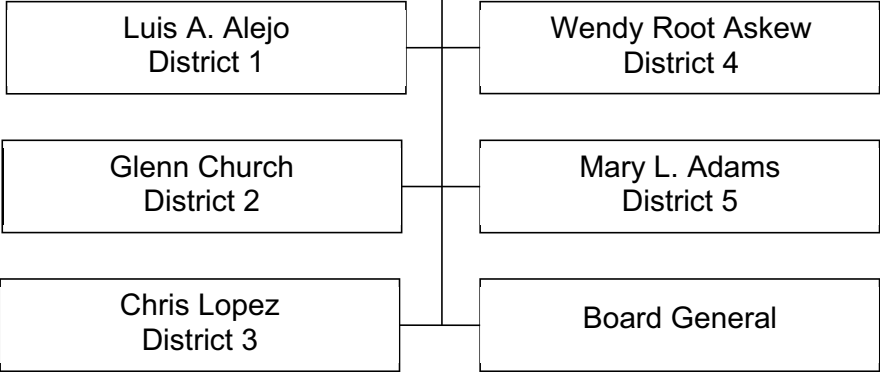

Staffing Trends

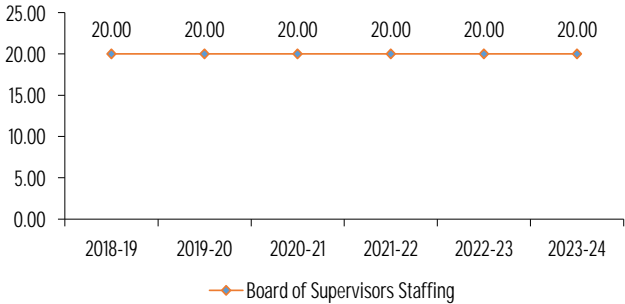

Expenditure/Revenue History (in millions)

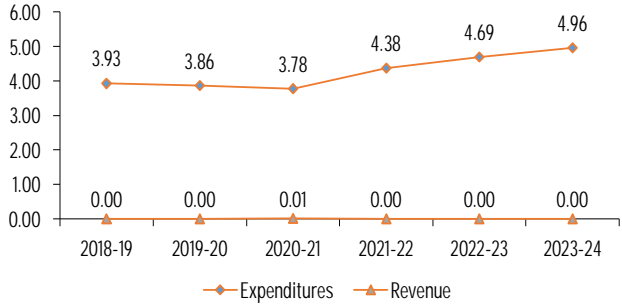

Use of Funds

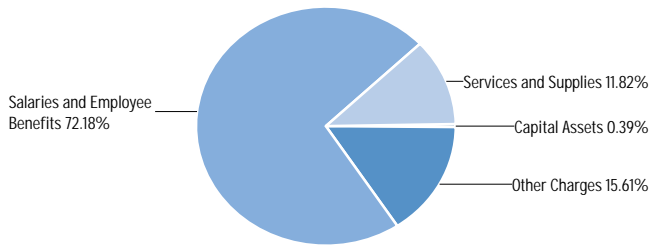

Source of Funds

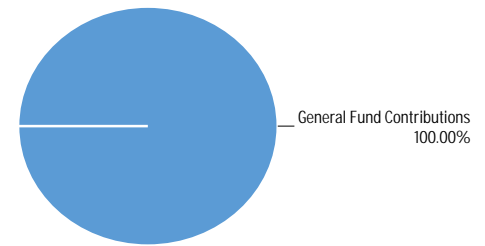

Use of Funds

Expenditures	Prior Year 2021-2022	Adopted Budget 2022-2023	CY Estimate 2022-2023	Requested Budget 2023-2024	Recommended Budget 2023-2024	Recommended Change from Adopted
Salaries and Employee Benefits	\$3,291,815	\$3,561,248	\$3,498,322	\$3,578,756	\$3,578,756	\$17,508
Services and Supplies	\$293,795	\$396,486	\$322,607	\$585,999	\$585,999	\$189,513
Other Charges	\$758,138	\$837,597	\$837,603	\$773,756	\$773,756	\$(63,841)
Capital Assets	\$34,566	—	\$33,687	\$19,500	\$19,500	\$19,500
Subtotal	\$4,378,314	\$4,795,331	\$4,692,219	\$4,958,011	\$4,958,011	\$162,680

Source of Funds

Revenues	Prior Year 2021-2022	Adopted Budget 2022-2023	CY Estimate 2022-2023	Requested Budget 2023-2024	Recommended Budget 2023-2024	Recommended Change from Adopted
Miscellaneous Revenues	\$10	—	—	—	—	—
Subtotal	\$10	—	—	—	—	—
General Fund Contributions	\$4,378,304	\$4,795,331	\$4,692,219	\$4,958,011	\$4,958,011	\$162,680
Total Source of Funds	\$4,378,314	\$4,795,331	\$4,692,219	\$4,958,011	\$4,958,011	\$162,680

Summary of Recommendation

The County Administrative Office (CAO) prepares the budget for the Board of Supervisors, working with district staff to identify funding requirements. The FY 2023-24 Recommended Budget includes appropriations for each Board district to meet salary and benefits requirements at a level consistent with negotiated salary, benefits, and earned step increases. Appropriations also provide for fixed, non-discretionary expenditures and day-to-day business-related costs necessary to meet district and County representation requirements.

Recommended appropriations total \$4,958,011, an increase of \$162,680 (3%) above the FY 2022-23 Adopted Budget. The increase is attributed to a raise in general liability, pension contributions, and various services and supplies; partially offset by a decrease in cost plan costs.

Budget Impacts

The Recommended Budget maintains status quo staffing and operations.

Prior Year Accomplishments

The Board of Supervisors adopted Strategic Initiatives setting forth policies, key objectives and performance measures for Economic

Development, Administration, Health and Human Services, Infrastructure, and Public Safety:

Economic Development- "Enhancing the well-being and prosperity of Monterey County Residents"

Strategic Initiative: Through collaboration, strengthen economic development to ensure a diversified and healthy economy.

Administration- "Efficient and Effective Government Operations"

Strategic Initiative: Promote an organization that practices efficient and effective resource management and is recognized for responsiveness, strong customer orientation, accountability and transparency.

Health and Human Services- "Health and Wellness for Monterey County Residents"

Strategic Initiative: Improve health and quality of life through County supported policies, programs, and services; promoting access to equitable opportunities for healthy choices and healthy environments in collaboration with communities.

Infrastructure- "Meeting our Facilities, Water, Technology and Transportation Needs"

Strategic Initiative: Plan and develop a sustainable, physical infrastructure that improves the quality of life for County residents and supports economic development results.

consistently meet Board-adopted goals on behalf of Monterey County citizens. The Board will remain actively engaged with directing and achieving policy area Strategic Initiatives to meet key objectives.

Public Safety- "Creating Safe Communities"

Strategic Initiative: Create a safe environment for people to achieve their potential, leading businesses and communities to thrive and grow while reducing violent crimes.

Pending Issues

There are no pending issues.

Policy Considerations

There are no policy considerations.

Budget Year Goals

Continue implementation of adopted Strategic Initiatives and Key Objectives, which assure that County functions are performed to

Appropriation Expenditure Detail

	Prior Year 2021-2022	Adopted Budget 2022-2023	CY Estimate 2022-2023	Requested Budget 2023-2024	Recommended Budget 2023-2024	Recommended Change from Adopted	Fund Code	Budget Unit Code
Board-General (BOA001)	915,282	1,004,011	995,980	1,013,841	1,013,841	9,830	001	8012
District 1 (BOA001)	657,906	754,364	718,725	784,934	784,934	30,570	001	8013
District 2 (BOA001)	730,134	754,364	703,565	784,934	784,934	30,570	001	8014
District 3 (BOA001)	705,683	773,864	779,008	804,434	804,434	30,570	001	8015
District 4 (BOA001)	689,309	754,364	744,569	784,934	784,934	30,570	001	8016
District 5 (BOA001)	680,000	754,364	750,372	784,934	784,934	30,570	001	8017
Subtotal	\$4,378,314	\$4,795,331	\$4,692,219	\$4,958,011	\$4,958,011	\$162,680		

Budget Units

	Prior Year 2021-2022	Adopted Budget 2022-2023	CY Estimate 2022-2023	Requested Budget 2023-2024	Recommended Budget 2023-2024	Recommended Change from Adopted
Board-General	\$915,282	\$1,004,011	\$995,980	\$1,013,841	1,013,841	\$9,830
District 1	\$657,906	\$754,364	\$718,725	\$784,934	784,934	\$30,570
District 2	\$730,134	\$754,364	\$703,565	\$784,934	784,934	\$30,570
District 3	\$705,683	\$773,864	\$779,008	\$804,434	804,434	\$30,570
District 4	\$689,309	\$754,364	\$744,569	\$784,934	784,934	\$30,570
District 5	\$680,000	\$754,364	\$750,372	\$784,934	784,934	\$30,570
Subtotal	\$4,378,314	\$4,795,331	\$4,692,219	\$4,958,011	\$4,958,011	\$162,680

Adopted FY 2022-23 to Recommended FY 2023-24 Positions

Classification Code	Classification Label	Adopted Budget 2021-2022	Adopted Budget 2022-2023	Recommended Budget 2023-2024	Change
10A01	BOARD OF SUPERVISORS CHAIRMAN	1.00	1.00	1.00	0.00
10A02	BOARD OF SUPERVISORS MEMBER	4.00	4.00	4.00	0.00
14H02	BOARD OF SUPERVISORS POLICY ANALYST	5.00	5.00	10.00	5.00
14H10	BOARD OF SUPERVISORS CHIEF OF STAFF	5.00	5.00	5.00	0.00
80A90	BOARD OF SUPERVISORS EXECUTIVE ASSISTANT	5.00	5.00	0.00	(5.00)
	Total	20.00	20.00	20.00	0.00

Emergency Management

Departmental Overview:

The Department of Emergency Management (DEM) leads and coordinates major countywide services including community disaster preparedness, public preparedness education, emergency planning, public employees' emergency and disaster skills development, response planning, alert and warning, operational area incident response management and short-term recovery. The Department develops and sustains effective relationships with residents, County departments, cities, special districts, state and federal agencies, community-based organizations and other allied stakeholder organizations.

Programs and Functions:

The Department has been developing to 8 functional program areas in the process of transitioning from a division of the County Administrative Office to a standalone department.

1) Administrative Services is responsible for management and coordination of internal administrative functions for the Department. 2) Grants and Finance is responsible for applying for and administering grants. 3) Community Resilience is responsible for developing and implementing a robust Community Resilience Plan detailing 61 initiatives for creating stronger communities. 4) Emergency Services Planning is responsible for developing and maintaining the Operational Area Emergency Operations Plan, functional annexes, hazard annexes, County's Continuity of Operations Plan (COOP) Program, hazard mitigation strategies, and long-term strategic planning. 5) Training and Exercise is responsible for building a Disaster Service Worker training program and conducting training for County staff and Operational Area jurisdictions and facilitating exercises to validate plans and training. 6) The 24/7 Duty Officer program coordinates the and manages emergency resources during incidents. Duty Officer is the point of contact and action agent for all threat notifications and public warning missions and the on-scene liaison to County departments, municipalities, and special districts during emergencies. 7) The Alert & Warning program maintains the 24/7 communications technology, policies, training, multi-jurisdictional coordination that enables delivery of public warnings via the Alert Monterey County, Wireless Emergency Alert, Emergency Alert System, and National Oceanic and Atmospheric Administration (NOAA) weather radio system. 8) Emergency Operations Center is managed and maintained by the Department including the facility and systems, department response fleet vehicles, and coordinating services provided in an emergency, including but not limited to mass care, commodity distribution, transportation, environmental health, infrastructure protection, communications, Community Emergency Response Teams, situational assessment, information dissemination, and planning.

The Department's Contributions to Monterey County's Strategic Initiatives:

Encouraging municipalities to consider health equity and "Health in All Policies" in future community development plans. Conducting ongoing quality improvement activities; using customer satisfaction survey results to improve public services. Ensuring equitable access to physical and emotional health services and working with community partners to address the root causes of health disparities. Assuring well water, stream, and beach water quality through ongoing testing and public information announcements. Promoting protective factors against violence; advocating for the use of safety equipment and safe routes to school; assuring timely and appropriate pre-hospital transportation; and responding to disasters.



Operating Budget: \$4,396,683
Positions (FTEs): 9.00

Kelsey Scanlon
Director of Emergency Management

Department of Emergency Management

Staffing Trends

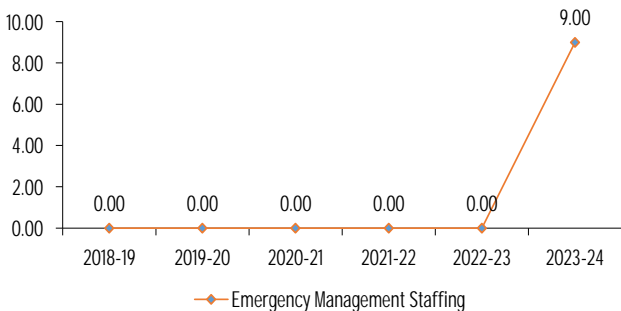

Expenditure/Revenue History (in millions)

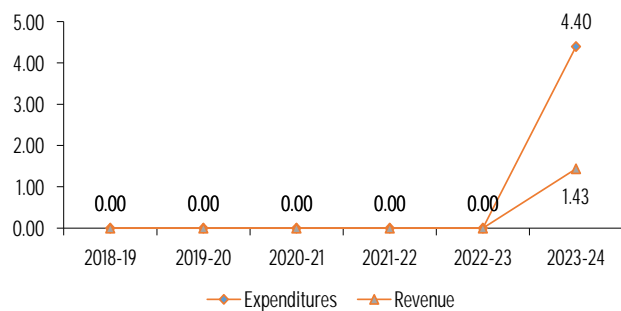

'The Department of Emergency Management (DEM) leads and coordinates major countywide services including community disaster preparedness, public preparedness education, emergency planning, public employees' emergency and disaster skills development, response planning, alert and warning, operational area incident response management and short-term recovery.

Key Performance Measures	2020-21 Actual	2021-22 Actual	2022-23 Mid-Year
Emergency Alerts Disseminated.	N/A	N/A	200
Local Emergencies Proclaimed.	N/A	N/A	3
Plans Developed or Updated.	N/A	N/A	4

Use of Funds

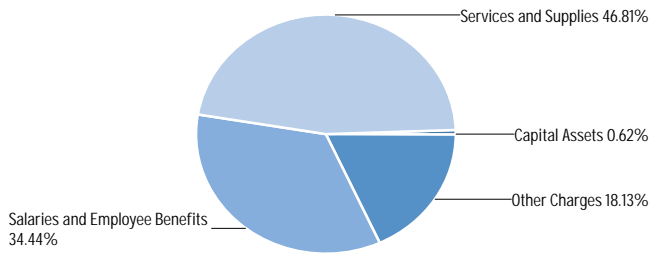

Source of Funds

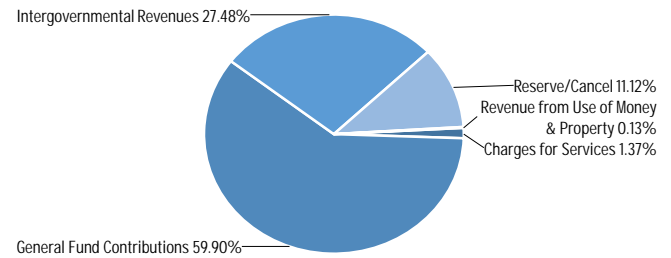

Use of Funds

Expenditures	Prior Year 2021-2022	Adopted Budget 2022-2023	CY Estimate 2022-2023	Requested Budget 2023-2024	Recommended Budget 2023-2024	Recommended Change from Adopted
Salaries and Employee Benefits	—	—	—	\$1,514,347	\$1,514,347	\$1,514,347
Services and Supplies	—	—	—	\$2,293,091	\$2,058,091	\$2,058,091
Other Charges	—	—	—	\$796,954	\$796,954	\$796,954
Capital Assets	—	—	—	\$107,291	\$27,291	\$27,291
Subtotal	—	—	—	\$4,711,683	\$4,396,683	\$4,396,683

Source of Funds

Revenues	Prior Year 2021-2022	Adopted Budget 2022-2023	CY Estimate 2022-2023	Requested Budget 2023-2024	Recommended Budget 2023-2024	Recommended Change from Adopted
Revenue from Use of Money & Property	—	—	—	\$6,444	\$6,444	\$6,444
Intergovernmental Revenues	—	—	—	\$1,359,239	\$1,359,239	\$1,359,239
Charges for Services	—	—	—	\$68,000	\$68,000	\$68,000
Subtotal	—	—	—	\$1,433,683	\$1,433,683	\$1,433,683
General Fund Contributions	—	—	—	\$2,728,000	\$2,413,000	\$2,413,000
General Fund - Assigned Fund Balance	—	—	—	\$550,000	\$550,000	\$550,000
Total Source of Funds	—	—	—	\$4,711,683	\$4,396,683	\$4,396,683

Summary of Recommendation

The FY 2023-24 budget is recommended at \$4,396,683 in expenditures, revenues of \$1,433,683, general fund contribution of \$2,413,000, and \$550,000 of restricted fund balance use. The recommendation includes \$95,000 in augmentations (\$45,000 for cloud based WebEOC upgrade and \$50,000 for the winter storm after action report) but excludes \$315,000 for other augmentations. This department was created in the middle of FY 2022-23 and this is the first fiscal year a recommended budget was developed for the department.

Budget Impacts

The recommended budget includes funding for core operations but does not include funding for a new duty officer vehicle (\$80,000), the emergency operations center site review and needs assessment (\$80,000), a new grant program development request (\$115,000), and website development (\$40,000).

Prior Year Accomplishments

Fiscal Year 22-23 was a significant year for the Office of Emergency Services. On December 7, 2022, the County of Monterey Board of Supervisors created the County of Monterey Department of Emergency Management, Chapters 2.12 and 2.68 of the Monterey County Code. The Department transitioned from a division of the County Administrative Office to an independent department of the County of Monterey. With the change of the status of the emergency management organization and addition of new positions, the Department of Emergency Management worked with the County Communications Division to develop a new brand. The new brand established a logo for the agency. With the change of the status of the emergency management organization and addition of new positions, the Department of Emergency Management worked with the County Communications Division to develop a new brand. The new brand established a logo for the agency. The Monterey County Operational Area Emergency Operations Center remained activated throughout the duration of FY22-23 in the response to the COVID-19 Pandemic. As of July 2022, the last remaining COVID-19+ Alternate Housing Site at San Lorenzo Park was demobilized. The San Lorenzo Park RV Campground in King City, which served as an Alternate Housing Site supporting Covid-19 recovery in Monterey County for more than two

years, reopened to the public on November 1, 2022. The Monterey County Department of Social Services (MCDSS), through the Care and Shelter Branch of the Emergency Operations Center, has been responsible for staffing and managing the COVID-19 Monterey County Alternate Housing Site Program since March 2020. Cumulatively, this program served approximately 1,390 community members throughout the duration of the program.

The COVID-19 Funeral and Burial Assistance Program remains active since its inception in Summer 2021.

In May 2023, the COVID-19 Emergency Proclamation was allowed to expire. In January and March 2023, the Monterey County Operational Area Emergency Operations Center was activated to Level 1, its highest level in response to heavy rain and wind events causing damage to public infrastructure and private property within Monterey County including localized flooding, roadway slope erosion and embankment slip-outs, debris flows, landslides, and culvert failure affecting the safety of said roadways; obstruction of public roadways from storm water, storm debris and roadway failure; damage to storm drain infrastructure; and damage to public and private utilities and damage to public facilities and parks; such damages resulting in road closures, areas of isolation, loss of power and other critical infrastructure affecting the public's safety.

- Disseminated 200+ emergency alerts and warnings to the community.

- Reinvigorated the countywide Tsunami Ready program and collaborated with California Geological Survey, California Governor's Office of Emergency Services, and the National Weather Service to host a Tsunami Response Planning Workshop.

- Developed, approved, and implemented the 2022-2025 Strategic Plan, Evacuation and Transportation Plan, Community Resilience Plan, Multi-Jurisdictional Hazard Mitigation Plan.

- Worked with Monterey County Free Libraries to establish Libraries as Disaster Hubs. During the 2022 Excessive Heat Event, the San Lucas Branch of the Monterey County Free Libraries was utilized as a cooling center for 3 days and served 85 community members seeking relief from 115-degree heat waves.

- Utilized Public Safety Power Shutoff grant funds to update the electrical infrastructure to allow the connection of portable generators at the Laguna Seca Fuel Depot, Greenfield Branch, San Lucas Branch, and Castroville Branch of the Monterey County Free Libraries.

- The annual Monterey County EOC Exercise was a functional exercise based on a catastrophic earthquake and fast-moving wildfire in the Del Monte Forest. The exercise focused on testing and practicing the following core capabilities: Critical Transportation, Operational Coordination, Logistics and Supply Chain Management, Public Information and Warning, Operational Communication, and Mass Care and Shelter. The Monterey County Operational Area Emergency Operations Center was fully activated. Additionally, as part of the Hospital Preparedness Program (HPP) Medical Response and Surge Exercise (MRSE), the Community Hospital of the Monterey Peninsula (CHOMP), Salinas Valley Memorial Hospital (SVMH), and Natividad Hospital. A total of 81 people participated in the exercise, with 63 County staff and 18 representatives from external agencies.

- The Community Resilience program initiated 36 of the 61 initiatives and reached over 3000+ community members. Funding for this program ended in March 2023.

- In 2022, the agency began evaluating Alert and Warning Systems (AWS) in response to the potential significant pricing changes from the existing AWS vendor, Everbridge Inc, and the lack of a consistent AWS vendor from the California Office of Emergency Services (Cal OES) Next Generation 9-1-1 (NG9-1-1) program. On October 28th, 2022, the agency entered into an agreement for an Emergency Notification Platform and Comprehensive Evacuation Management Platform with Genasys Inc. for the use of the Genasys GEMS

Platform and the Genasys Zonehaven Platform. The Genasys GEMS Emergency Notification Platform provides mass notification across a range of social media and web interfaces and has FEMA demonstrated IPAWS capabilities as an Alert Origination Software Provider. The Genasys Zonehaven system is a comprehensive evacuation management platform that consolidates a range of first response and public information tools for evacuation planning, support, and operations. This includes an evacuation mapping feature that offers digital, cloud-based, and printable options for dissemination.

- The Equity Officer position in the Emergency Operations Center was established and staffed for the first time during the 2023 Winter Storm events in January and March. The Equity Officer position is a management position that provides technical expertise, advice, and recommendations directly to the EOC Manager/Director regarding equity issues in emergency services, operations, and communications. This role will ensure that equity issues are considered in operational period objectives, response strategies and tactics. Vulnerable groups include those who are most at-risk of disparate impacts and experience inequities, such as access and functional needs and historically disadvantaged populations (ex. racial minorities, those with limited English proficiency, and immigrant populations).

- Provided direct support during large-pre-planned events at the request of the Monterey County Sheriff's Office Community Services Division to assist in the reduction of threats to soft targets and crowded spaces.

- Hosted the annual Countywide Winter Season and Wildfire Season Coordination Meetings. These meetings provide for the coordination of information sharing and strategizing amongst county departments, first responder agencies, municipal jurisdictions, and non-profit stakeholders.

Budget Year Goals

- The Department will continue to coordinate short-term recovery operations and support the planning of long-term recovery efforts for communities affected by the 4683DR-CA – 2022-23 Severe Winter Storms, Flooding, Landslides, and Mudslides and 4699DR-CA – 2023 March Severe Winter Storms, Flooding, Landslides, and Mudslides.

- The Department will continue to develop Emergency Operations Center Teams and conduct training for Disaster Service Workers.

- The Department will support the Monterey County Water Resources Agency to plan and conduct a functional exercise of the Emergency Operations Center utilizing a scenario based on the failure of the Nacimiento Dam.

- The Department will test, transition, and promote the new Alert and Warning System utilizing the Genasys, Inc. software, Genasys Emergency Management System, and the Evacuation Tool, Zonehaven.

Pending Issues

The Department is responsible for coordinating and providing general oversight of financial cost recovery of eligible expenses related to disasters. At present, the Department is still processing reimbursements from projects affiliated with the following Gubernatorial Declarations: 4482DR-CA – 2020 COVID-19 Pandemic; 4558DR-CA – 2020 Carmel, Dolan, and River Fires; 4683DR-CA – 2022-23 Severe Winter Storms, Flooding, Landslides, and Mudslides; 4699DR-CA – 2023 March Severe Winter Storms, Straight-line Winds, Flooding, Landslides, and Mudslides. Recovery planning and initiatives will be a robust and on-going effort that will place additional staffing and workload demands on the new

department; Some non-essential or unmandated functions may be suspended to prioritize recovery needs for the community of Pajaro.

Policy Considerations

There are no policy considerations.

Appropriation Expenditure Detail

	Prior Year 2021-2022	Adopted Budget 2022-2023	CY Estimate 2022-2023	Requested Budget 2023-2024	Recommended Budget 2023-2024	Recommended Change from Adopted	Fund Code	Budget Unit Code
Emergency Management (DEM001)	—	—	—	2,929,737	2,614,737	2,614,737	001	8588
Emergency Operations Center (DEM001)	—	—	—	630,715	630,715	630,715	001	8589
Homeland Security Grant (DEM002)	—	—	—	1,151,231	1,151,231	1,151,231	024	8590
Subtotal	—	—	—	\$4,711,683	\$4,396,683	\$4,396,683		

Budget Units

	Prior Year 2021-2022	Adopted Budget 2022-2023	CY Estimate 2022-2023	Requested Budget 2023-2024	Recommended Budget 2023-2024	Recommended Change from Adopted
Emergency Management	—	—	—	\$2,929,737	2,614,737	\$2,614,737
Emergency Operations Center	—	—	—	\$630,715	630,715	\$630,715
Homeland Security Grant	—	—	—	\$1,151,231	1,151,231	\$1,151,231
Subtotal	—	—	—	\$4,711,683	\$4,396,683	\$4,396,683

Adopted FY 2022-23 to Recommended FY 2023-24 Positions

Classification Code	Classification Label	Adopted Budget 2021-2022	Adopted Budget 2022-2023	Recommended Budget 2023-2024	Change
11A13	DIRECTOR OF EMERGENCY MANAGEMENT	0.00	0.00	1.00	1.00
14A25	EMERGENCY SERVICES MANAGER	0.00	0.00	1.00	1.00
14C30	MANAGEMENT ANALYST II	0.00	0.00	1.00	1.00
20B95	FINANCE MANAGER I	0.00	0.00	1.00	1.00
41G01	EMERGENCY SERVICES PLANNER	0.00	0.00	4.00	4.00
80A33	ADMINISTRATIVE SECRETARY	0.00	0.00	1.00	1.00
	Total	0.00	0.00	9.00	9.00

Augmentation Requests

Request Code	Request Name	Ranking Type Name	Requested Amount	Requested FTE	Recommended Budget	Recommended FTE
1040-8588-001-AUG1	Duty Officer Vehicle	New Program/Service w/ General Fund Funding	80,000	-	-	-
1040-8588-001-AUG2	Grant Program Development	New Program/Service w/ General Fund Funding	115,000	-	-	-
1040-8588-001-AUG3	EOC Site Review and Needs Assessment	New Program/Service w/ General Fund Funding	80,000	-	-	-
1040-8588-001-AUG4	Outreach/ Website Development	New Program/Service w/ General Fund Funding	40,000	-	-	-
1040-8588-001-AUG5	Cloud Based WebEOC Upgrade	New Program/Service w/ General Fund Funding	45,000	-	45,000	-
1040-8589-001-AUG1	Winter Storm After Action Report	New Mandated Program/ Service w/ General Fund Funding	50,000	-	50,000	-
	Grand Total:		\$410,000	-	\$95,000	-

Emergency Management

(Budget Unit 8588—Fund 001—Appropriation Unit DEM001)

Use of Funds

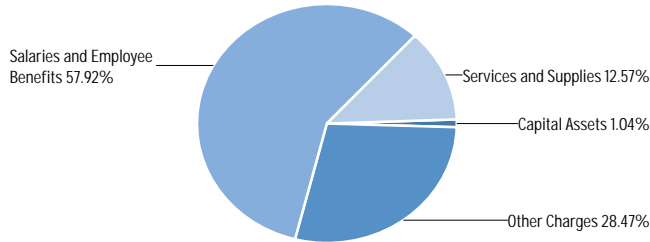

Source of Funds

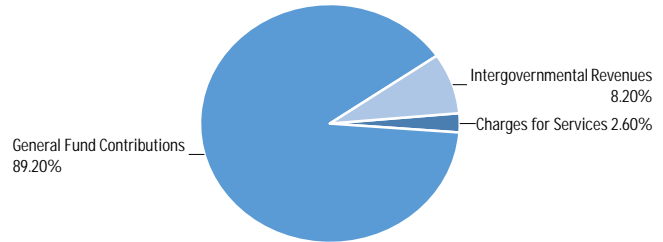

Use of Funds

Expenditures	Prior Year 2021-2022	Adopted Budget 2022-2023	CY Estimate 2022-2023	Requested Budget 2023-2024	Recommended Budget 2023-2024	Recommended Change from Adopted
Salaries and Employee Benefits	—	—	—	\$1,514,347	\$1,514,347	\$1,514,347
Services and Supplies	—	—	—	\$563,729	\$328,729	\$328,729
Other Charges	—	—	—	\$744,370	\$744,370	\$744,370
Capital Assets	—	—	—	\$107,291	\$27,291	\$27,291
Subtotal	—	—	—	\$2,929,737	\$2,614,737	\$2,614,737

Source of Funds

Revenues	Prior Year 2021-2022	Adopted Budget 2022-2023	CY Estimate 2022-2023	Requested Budget 2023-2024	Recommended Budget 2023-2024	Recommended Change from Adopted
Intergovernmental Revenues	—	—	—	\$214,452	\$214,452	\$214,452
Charges for Services	—	—	—	\$68,000	\$68,000	\$68,000
Subtotal	—	—	—	\$282,452	\$282,452	\$282,452
General Fund Contributions	—	—	—	\$2,647,285	\$2,332,285	\$2,332,285
Total Source of Funds	—	—	—	\$2,929,737	\$2,614,737	\$2,614,737

Unit Description

The Department of Emergency Management (DEM) ensures that Monterey County has the capability and sustained capacity to prepare for, respond to, and recover from any natural, technological, or human-related emergency or disaster. Responsibilities include coordinating public awareness and education on community risks, hazards, and preparedness actions. The DEM also ensures that the whole community, including public safety, governmental leadership, private and non-profit agencies are fully prepared to engage in response, recovery, and mitigation operations. To accomplish this, the DEM develops and maintains a variety of emergency planning efforts, including incident response plans, and hazard and function-specific plans. The coordination and collaboration between federal, state, local, and non-government agencies is the cornerstone of DEM

operations. The DEM operates and activates the Monterey County Emergency Operations Center (EOC) during emergency conditions.

Recommended FY 2023-24 Positions

Classification Code	Classification Label	FTE
11A13	DIRECTOR OF EMERGENCY MANAGEMENT	1.00
14A25	EMERGENCY SERVICES MANAGER	1.00
14C30	MANAGEMENT ANALYST II	1.00
20B95	FINANCE MANAGER I	1.00
41G01	EMERGENCY SERVICES PLANNER	4.00
80A33	ADMINISTRATIVE SECRETARY	1.00
Total		9.00

Emergency Operations Center

(Budget Unit 8589—Fund 001—Appropriation Unit DEM001)

Use of Funds

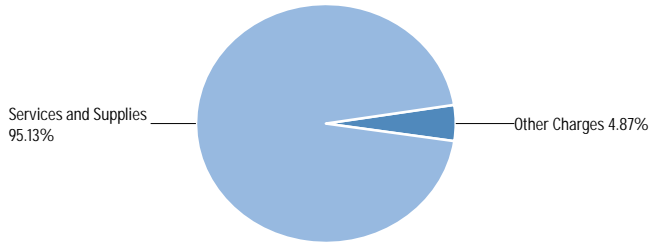

Source of Funds

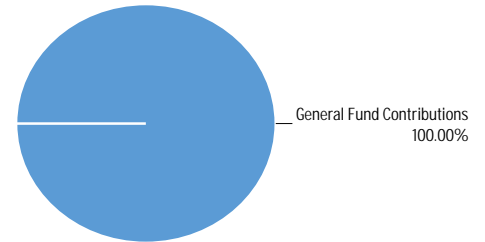

Use of Funds

Expenditures	Prior Year 2021-2022	Adopted Budget 2022-2023	CY Estimate 2022-2023	Requested Budget 2023-2024	Recommended Budget 2023-2024	Recommended Change from Adopted
Services and Supplies	-	-	-	\$600,000	\$600,000	\$600,000
Other Charges	-	-	-	\$30,715	\$30,715	\$30,715
Subtotal	-	-	-	\$630,715	\$630,715	\$630,715

Source of Funds

Revenues	Prior Year 2021-2022	Adopted Budget 2022-2023	CY Estimate 2022-2023	Requested Budget 2023-2024	Recommended Budget 2023-2024	Recommended Change from Adopted
General Fund Contributions	-	-	-	\$80,715	\$80,715	\$80,715
Cannabis Tax Assignment	-	-	-	\$550,000	\$550,000	\$550,000
Fund Balance						
Total Source of Funds	-	-	-	\$630,715	\$630,715	\$630,715

Unit Description

The Department of Emergency Management (DEM) operates and activates the Monterey County Emergency Operations Center (EOC)

during emergency conditions. This unit will capture emergency activities not related to normal operations of DEM.

DEM Grants

(Budget Unit 8590—Fund 024—Appropriation Unit DEM002)

Use of Funds

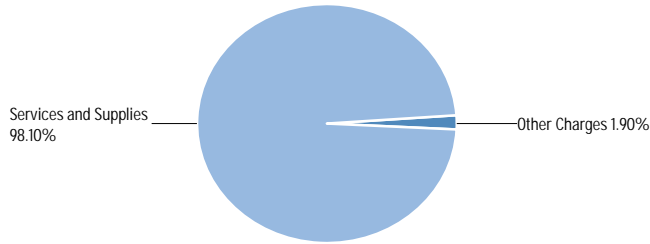

Source of Funds

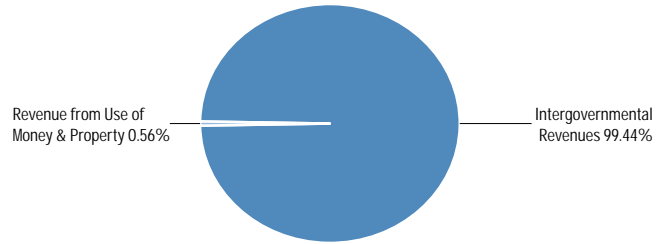

Use of Funds

Expenditures	Prior Year 2021-2022	Adopted Budget 2022-2023	CY Estimate 2022-2023	Requested Budget 2023-2024	Recommended Budget 2023-2024	Recommended Change from Adopted
Services and Supplies	—	—	—	\$1,129,362	\$1,129,362	\$1,129,362
Other Charges	—	—	—	\$21,869	\$21,869	\$21,869
Subtotal	—	—	—	\$1,151,231	\$1,151,231	\$1,151,231

Source of Funds

Revenues	Prior Year 2021-2022	Adopted Budget 2022-2023	CY Estimate 2022-2023	Requested Budget 2023-2024	Recommended Budget 2023-2024	Recommended Change from Adopted
Revenue from Use of Money & Property	—	—	—	\$6,444	\$6,444	\$6,444
Intergovernmental Revenues	—	—	—	\$1,144,787	\$1,144,787	\$1,144,787
Subtotal	—	—	—	\$1,151,231	\$1,151,231	\$1,151,231
Fund Balance	—	—	—	—	—	—
Total Source of Funds	—	—	—	\$1,151,231	\$1,151,231	\$1,151,231

Unit Description

The Homeland Security Grant unit was created in FY 2012-13 to separate the grant funds from the Department of Emergency Management (DEM) operational expenditures. The separation of

funds facilitates improved tracking and auditing. The DEM administers funds for authorized training, projects, and purchases for participating agencies.

County Administrative Office

Departmental Overview:

The County Administrative Office (CAO) serves as the chief policy and fiscal advisor to the County Administrative Officer and the Board of Supervisors (BOS). The CAO aids and advises the BOS through coordination of County operations and responses to and resolution of countywide issues and challenges. The CAO promotes responsible resource allocation, protects the financial integrity of the County and provides independent analysis on policies. This responsibility includes the recommendation of the annual County budget, representation of the BOS in relationships with other agencies, and assistance to departments in analyzing new or changed systems, procedures, and organizations.

Programs and Functions:

The CAO has six major divisions within its organization: Administration and Finance, Budget and Analysis, Contracts-Purchasing, Intergovernmental and Legislative Affairs (IGLA), Office of Community Engagement & Strategic Advocacy (OCESA), and Economic Development Administration. The Administration and Finance Division includes the County Administrative Officer, administrative staff, and finance staff. Budget and Analysis provides countywide financial management and policy analysis. The IGLA Division includes the IGLA, Cannabis, Sustainability, Media/ Communications, Homeless Services, Office of Emergency Services (OES), and Workforce Development Board (WDB). The OCESA includes all CAO outreach programs to foster community engagement and involvement.

In addition, the CAO performs countywide (non-departmental) functions, including: annual debt service, contributions to fire agencies, contributions to other funds within the County and external agencies, appropriations for contingencies, memberships in governmental organizations, enterprise resource planning, required support for trial courts, and appropriations of realignment monies for health and social services programs.

The CAO continues to engage in leadership and change management with the focus to provide continuous improvement in the quality, efficiency, and effectiveness of County operations.

The Office's Contributions to Monterey County's Strategic Initiatives:

The CAO addresses each of the Strategic Initiative Policy Areas (Economic Development, Administration, Health & Human Services, Infrastructure, and Public Safety) by achieving a balanced budget each year that sustains core County services, improving efficiency and effectiveness of County programs, providing leadership for an array of countywide initiatives and projects, and recognized for responsiveness, strong customer orientation, accountability, and transparency.

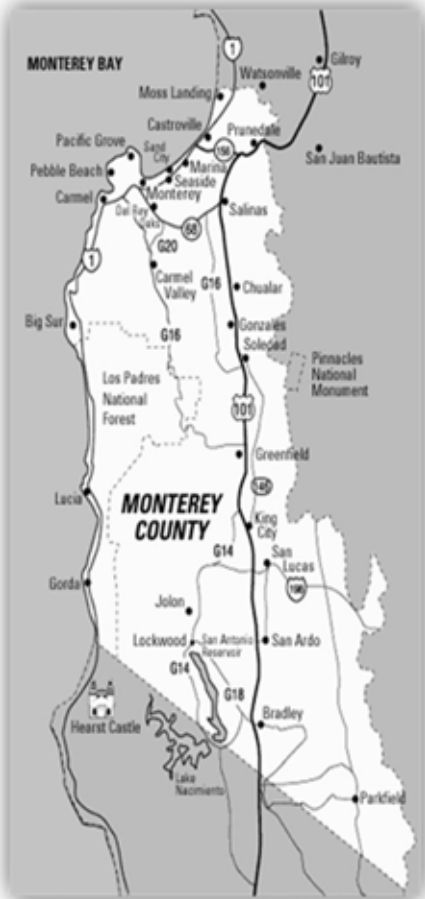

County Administrative Office

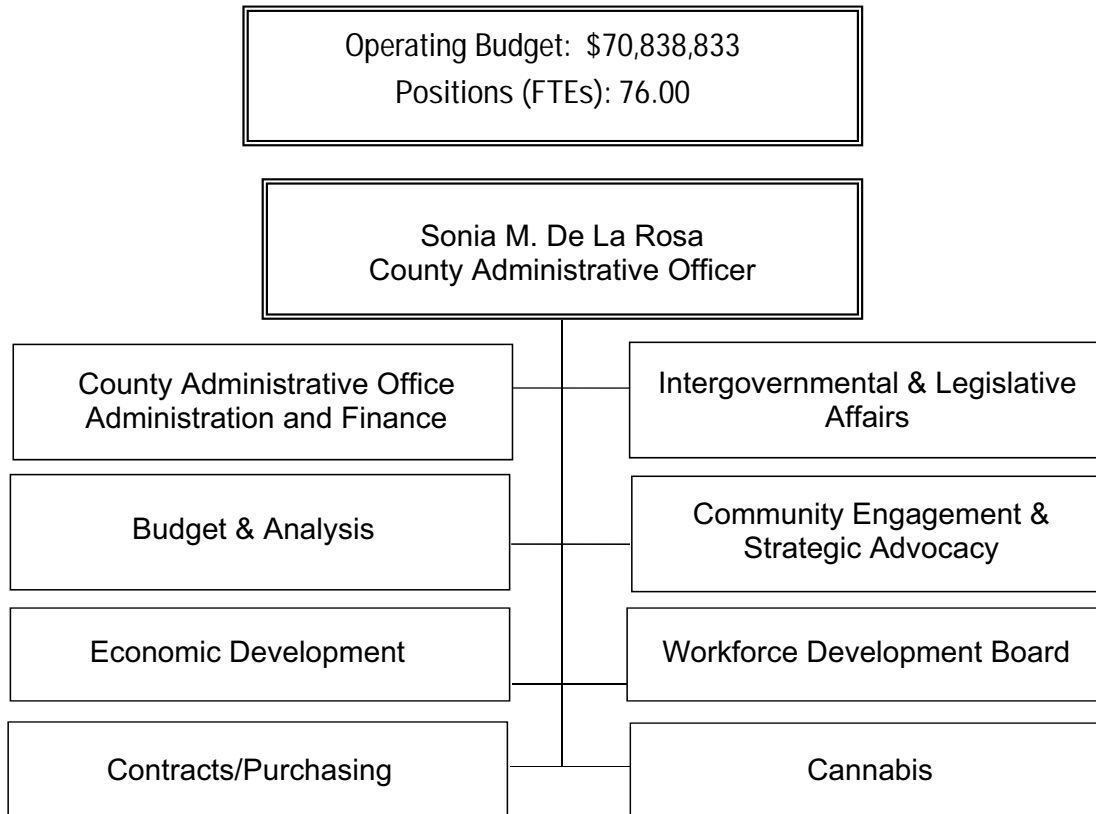

Staffing Trends

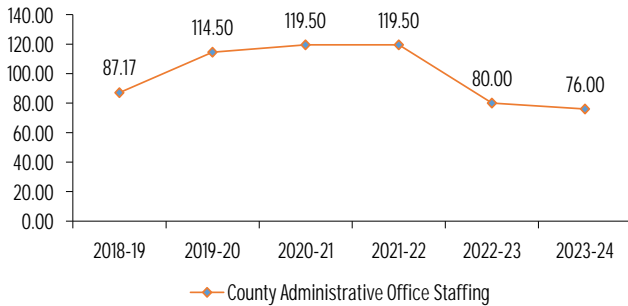

Expenditure/Revenue History (in millions)

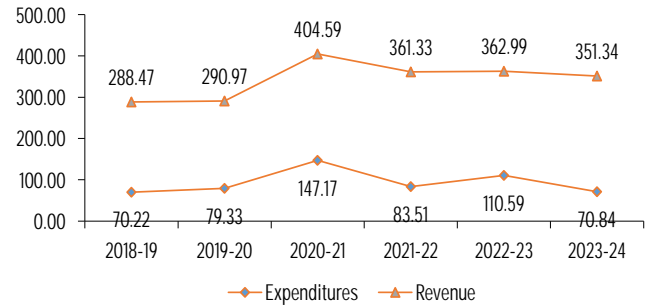

The County Administrative Office (CAO) functions as the chief policy and fiscal advisor to the County Administrative Officer and the Board of Supervisors for countywide priorities and issues.

Key Performance Measures	2020-21 Actual	2021-22 Actual	2022-23 Mid-Year
Ratings of General Obligation Bonds (Fitch and S&P). Target = AAA	AAA	AAA	AAA
General Fund annual operating surplus: actual revenue minus actual expenditures. Target = >\$0	\$24,995,250	\$14,402,382	N/A
Percent of general fund budget reserved for unanticipated emergencies (contingencies). Target = 1%.	1.00%	1.00%	0.65%
Total utility costs for Monterey County facilities except NMC.	\$9,157,219	\$9,901,007	\$4,478,117

Use of Funds

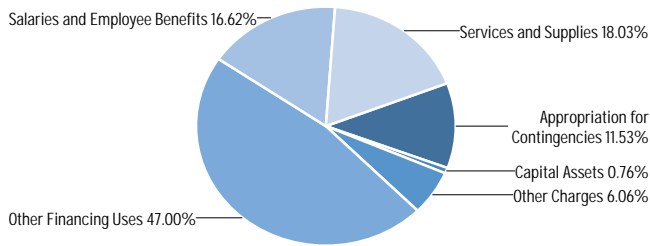

Source of Funds

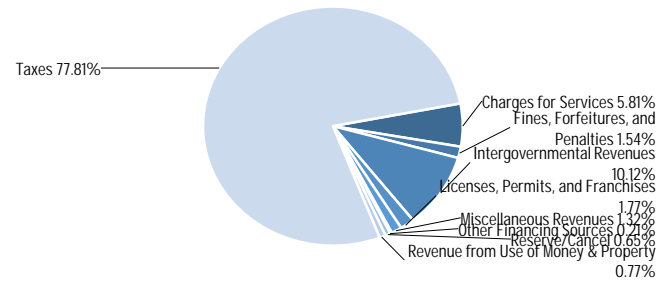

Use of Funds

Expenditures	Prior Year 2021-2022	Adopted Budget 2022-2023	CY Estimate 2022-2023	Requested Budget 2023-2024	Recommended Budget 2023-2024	Recommended Change from Adopted
Salaries and Employee Benefits	\$13,701,324	\$12,190,017	\$11,599,206	\$12,119,568	\$11,776,385	\$(413,632)
Services and Supplies	\$35,162,361	\$14,026,742	\$11,057,953	\$13,195,696	\$12,770,672	\$(1,256,070)
Other Charges	\$(4,938,429)	\$4,434,755	\$4,420,855	\$4,335,442	\$4,295,442	\$(139,313)
Capital Assets	\$2,930,684	\$1,137,503	\$1,114,318	\$534,969	\$534,969	\$(602,534)
Other Financing Uses	\$36,556,647	\$73,796,489	\$81,350,180	\$30,853,419	\$33,291,419	\$(40,505,070)
Appropriation for Contingencies	\$97,536	\$7,899,722	\$1,042,660	\$8,169,946	\$8,169,946	\$270,224
Subtotal	\$83,510,122	\$113,485,228	\$110,585,172	\$69,209,040	\$70,838,833	\$(42,646,395)

Source of Funds

Revenues	Prior Year 2021-2022	Adopted Budget 2022-2023	CY Estimate 2022-2023	Requested Budget 2023-2024	Recommended Budget 2023-2024	Recommended Change from Adopted
Taxes	\$262,403,221	\$250,489,150	\$265,563,764	\$275,148,829	\$275,148,829	\$24,659,679
Licenses, Permits, and Franchises	\$7,766,352	\$5,715,477	\$6,260,703	\$6,260,703	\$6,260,703	\$545,226
Fines, Forfeitures, and Penalties	\$6,838,103	\$6,105,650	\$4,827,341	\$5,444,712	\$5,444,712	\$(660,938)
Revenue from Use of Money & Property	\$20,207,549	\$2,544,509	\$4,177,478	\$2,735,765	\$2,735,765	\$191,256
Intergovernmental Revenues	\$35,122,096	\$40,288,983	\$40,390,091	\$22,182,873	\$35,792,055	\$(4,496,928)
Charges for Services	\$9,760,108	\$5,322,578	\$5,378,006	\$20,559,673	\$20,559,673	\$15,237,095
Miscellaneous Revenues	\$6,463,402	\$4,465,304	\$4,878,988	\$4,664,635	\$4,664,635	\$199,331
Other Financing Sources	\$12,773,710	\$16,114,082	\$31,516,620	\$736,544	\$736,544	\$(15,377,538)
Subtotal	\$361,334,542	\$331,045,733	\$362,992,991	\$337,733,734	\$351,342,916	\$20,297,183
Other Funds - Fund Balance	\$(26,682,853)	\$(11,153,180)	\$(23,555,079)	\$(18,467,267)	\$(17,557,267)	\$(6,404,087)
General Fund Contributions	\$(251,141,567)	\$(206,407,325)	\$(228,852,740)	\$(252,345,427)	\$(265,234,816)	\$(58,827,491)
General Fund - Fund Balance	—	—	—	\$2,288,000	\$2,288,000	\$2,288,000
Total Source of Funds	\$83,510,122	\$113,485,228	\$110,585,172	\$69,209,040	\$70,838,833	\$(42,646,395)

Summary of Recommendation

The FY 2023-24 Recommended Budget for the CAO is \$70,838,833, a decrease of \$42,646,395 from the prior year adopted budget. The decrease is primarily attributed to transfers to outside funds for Other Financing Uses and Building Improvement/ Replacement, and the reorganization of the Department of Emergency Management. The FY 2023-24 Recommended Budget also includes augmentations to support four new positions; one position in IGLA-Homeless Services and three positions for the ERP replacement project (1) in Budget & Analysis and (2) in Contracts-Purchasing. Nine positions were reallocated to the Department of Emergency Management. Recommended staffing for the CAO totals 59 FTE.

Budget Impacts

The FY 2023-24 Recommended Budget includes a \$18.6 million increase in discretionary revenue when compared to the FY 2022-23 budget. Most of this increase results from increases in property taxes (\$12.2 million) and transient occupancy taxes (\$12.2 million) with a corresponding decrease in cannabis revenue (\$2.8 million) and a decrease in American Rescue Plan Act (ARPA) revenue (\$6.8 million). The decrease in cannabis revenue results from a reduction of the cannabis tax rate in order to respond to the industry's challenges to remain a viable industry in the County. The reduction in the ARPA revenue is a result of the implementation of the County's three-year plan to use ARPA funds in diminishing amounts each subsequent fiscal year. Since FY 2023-24 represents the last fiscal year ARPA

funds are available, the amount allocated to this fiscal year is lower than the prior fiscal year and is also the last fiscal year these funds will be available. Beginning with FY 2024-25, the County will have to make adjustments to its expenditures to match only available ongoing local funds.

Prior Year Accomplishments

Published the Budget End of Year Report, a mid-year report recommending budget solutions to unfunded needs, County Financial Forecast, and the FY 2022-23 Recommended Budget. Facilitated budget workshops with department heads and the Board of Supervisors. Continued implementation of the American Rescue Plan Act (ARPA) spending plan which brought to the County \$84.3 million in federal funds. Continued oversight of the Monterey County Cannabis Program in collaboration with nine County departments.

Secured Victims of Crime Act (VOCA XC 22) grant funding from the California Governor's Office of Emergency Services (Cal OES) in the amount of \$222,870 for the provision of direct services to victims of crime in the County of Monterey. Funding sustains cost of direct services, referral and case management, training and education services conducted in partnership between the County and internal/external community partners within the county.

Developed and implemented the 2021-22 Legislative Program and 2022 Strategic Grant Services Program. Planned and facilitated the Board's annual Legislative Workshop with state and federal legislators representing the County. Advocated on proposed state and federal legislation that would directly impact the County and community. Developed and submitted the County's 2023 State Budget and FY 2023 Congressionally Designated Spending requests. Continued advocacy efforts as directed by the Board of Supervisors related to the County's COVID-19 pandemic response/ recovery and other emergency/ disaster events.

Conducted extensive background work required to begin preparation of the Community Climate Action Plan for Monterey County, a requirement of the County General Plan. This included extensive technical analysis related to the sources of greenhouse gas emissions in the County and a significant level of public outreach and stakeholder engagement with a broad range of community and economic interests. Developed a County policy on EV procurement in collaboration with Fleet management. Began work with County Facilities and Fleet programs to expand the availability of EV charging stations. Successfully obtained grant funding for several energy-related projects. Participated actively in a regional local government consortium created to facilitate regional competitiveness with energy-related grants.

The Monterey County Workforce Development Board (MCWDB) has applied for and received over \$5 million in grant funding to support residents of Monterey County and the region. A Regional Equity and Recovery Partnerships grant from the State will fund job training programs in the areas of Health Care, Ag Tech, and Culinary Arts in collaboration with the community colleges of Monterey, San Benito and Santa Cruz counties. The MCWDB has also received State grant funding to develop and implement a 325-hour pre-apprenticeship program, in partnership with the Monterey/Santa Cruz Building and Construction Trades Council, to train 126 individuals for apprenticeships in the various building trades. In response to a series of weather-related disasters affecting Monterey County this past winter, the MCWDB applied for a National Dislocated Worker Grant to provide temporary help to assist with the clean-up and restoration of public lands in Monterey County. The funding will provide wages

for 44 workers at various worksites, including County and State Parks.

The Homeless Services Program established the Monterey County Interdepartmental Committee on Homelessness (MC ICH) in partnership with the various divisions/bureaus/branches within the Departments of Social Services, Health, Public Works, County Administrative Office, Housing and Community Development, Military and Veterans Affairs, Water Resources Agency, and Sheriff's Office. Key functions of this committee are to reduce barriers for people experiencing homelessness, increase interdepartmental collaboration, empower frontline staff, identify and fill gaps in the County's homelessness response system, identify and address racial inequities, and build capacity to combat homelessness.

The County of Monterey Board of Supervisor's Homelessness Committee officially launched in August 2022. This committee receives regular updates and presentations on the current state of homelessness, including available and upcoming funding opportunities, housing/bed inventory, and census data.

The newly established homeless services position in the Department of Emergency Management provided much-needed resources to unsheltered Monterey County residents impacted by the storms by connecting people to shelter and long-term services to steward individuals and families toward permanent housing.

Budget Year Goals

Provide quality and informative budget products such as the Budget End of Year Report, County Financial Forecast, budget workshop materials, and the Recommended Budget to effectively communicate the condition of County finances, fiscal perspectives, and recommendations to assist policymakers in managing countywide resources.

Continuously manage ten diverse countywide programs and special projects, as assigned, and enhance the County's emergency response capabilities by increasing community engagement, increasing community preparedness, and expanding training.

Pending Issues

Discretionary revenue has continued to grow over the years, but this growth has not been sufficient to keep pace with the growth of county obligations. This imbalance was exacerbated during the pandemic, but the imbalance was covered by the County's receipt of one-time federal funds. The County has used these one-time funds to balance its budget over the last couple of fiscal years in order to respond to the pandemic. However, once these funds are exhausted, the County will have to make adjustments to balance the growth in obligations with the growth in discretionary revenue.

Policy Considerations

The recommended budget presents the Board with Transient Occupancy Tax (TOT) contributions to outside agencies as a fixed amount based on the FY 2019-20 contribution as directed by the Board during the adoption of the FY 2022-23 budget. The percentages for the Monterey County Business Council (MCCVB), the Arts Council, and the Film Commission remain at 6%, 1.98%, and 0.95%, respectively. The General Fund's contribution to the Road Fund is recommended to meet the Maintenance of Effort (MOE) of \$6,222,054.

Appropriation Expenditure Detail

	Prior Year 2021-2022	Adopted Budget 2022-2023	CY Estimate 2022-2023	Requested Budget 2023-2024	Recommended Budget 2023-2024	Recommended Change from Adopted	Fund Code	Budget Unit Code
Contributions - Proposition 172 (CAO007)	3,295,753	3,529,729	3,529,729	4,041,183	4,041,183	511,454	001	8028
Contributions-Other Agencies (CAO007)	4,831,337	3,238,847	1,438,847	836,945	836,945	(2,401,902)	001	8029
Trial Courts (CAO008)	7,971,665	8,937,113	7,963,192	8,288,269	8,288,269	(648,844)	001	8031
Contingencies (CAO020)	0	7,398,322	541,260	7,933,546	7,933,546	535,224	001	8034
County Memberships (CAO013)	81,682	81,682	81,682	85,664	85,664	3,982	001	8035
Medical Care Services (CAO016)	3,900,648	3,900,648	3,900,648	3,900,648	3,900,648	0	001	8037
Other Financing Uses (CAO017)	29,617,287	49,581,916	54,656,532	19,144,381	20,632,381	(28,949,535)	001	8038
Other General Expenditures (CAO014)	(106,253)	288,674	288,674	200,000	200,000	(88,674)	001	8039
Administration & Finance (CAO001)	492,575	242,830	129,133	(491,856)	(491,856)	(734,686)	001	8045
Budget & Analysis (CAO001)	1,361,341	1,545,814	1,530,151	1,664,492	1,707,856	162,042	001	8046
Contracts/Purchasing (CAO002)	(1,257,709)	(740,870)	(777,886)	(872,666)	(1,043,868)	(302,998)	001	8047
Intergovernmental & Legislative Affairs (CAO004)	1,923,592	2,957,949	3,078,962	2,711,401	2,395,032	(562,917)	001	8054
Office of Emergency Services (CAO005)	1,784,411	2,966,091	2,770,623	0	0	(2,966,091)	001	8056
Homeland Security Grant (CAO023)	529,162	1,645,959	1,660,959	0	0	(1,645,959)	024	8412
Office of Community Engagement & Strategic Advocacy (CAO024)	826,080	810,973	825,165	679,364	489,364	(321,609)	001	8440
Fleet Administration (CAO025)	(169,562)	0	0	0	0	0	001	8451
Shuttle (CAO025)	491	0	0	0	0	0	001	8452
Auxiliary Services (CAO027)	24,131	26,144	12,000	51,125	51,125	24,981	001	8472
Records Retention (CAO028)	(151,377)	0	0	0	0	0	001	8474
Workforce Development Board (CAO030)	8,496,290	8,681,924	8,391,372	10,470,579	10,430,579	1,748,655	021	8478
Vehicle Replacement Planning (CAO032)	2,330,080	0	0	0	0	0	478	8483
Rifle Range (CAO029)	209,126	0	0	0	0	0	001	8504
Enterprise Resource Planning (CAO034)	(599,082)	494,776	899,949	3,623,974	3,623,974	3,129,198	478	8506
Courier (CAO035)	(349,551)	0	0	0	0	0	001	8508
Mail (CAO035)	(131,541)	0	0	0	0	0	001	8509
Development Set-Aside (CAO036)	3,454,664	6,231,129	3,752,000	3,722,000	3,722,000	(2,509,129)	001	8512
Economic Development Administration (CAO038)	435,952	1,028,523	1,052,388	631,206	612,206	(416,317)	001	8514
Revolving Loan Program (CAO040)	511,873	1,150,500	1,150,500	1,150,500	1,150,500	0	011	8516
Cannabis (CAO004)	956,057	2,352,073	2,350,735	2,989,715	2,989,715	637,642	001	8533
Laguna Seca Track (CAO046)	21,769,139	0	0	0	0	0	453	8536
Building Improvement and Replacement (CAO047)	(10,447,078)	7,089,250	11,368,325	(3,412,698)	(2,462,698)	(9,551,948)	478	8539

County Administrative Office

Appropriation Expenditure Detail

	Prior Year 2021-2022	Adopted Budget 2022-2023	CY Estimate 2022-2023	Requested Budget 2023-2024	Recommended Budget 2023-2024	Recommended Change from Adopted	Fund Code	Budget Unit Code
Emergency Operations Center (CA0005)	3,147,200	305,000	0	0	0	(305,000)	001	8541
Equipment Replacement (CA0048)	(1,274,121)	(259,768)	(259,768)	(501,606)	(501,606)	(241,838)	478	8568
Pension Unfunded Liability (CA0049)	45,859	0	250,000	300,000	300,000	300,000	030	8570
Sustainability (CA0004)	0	0	0	2,062,874	1,947,874	1,947,874	001	8587
Subtotal	\$83,510,122	\$113,485,228	\$110,585,172	\$69,209,040	\$70,838,833	\$(42,646,395)		

Budget Units

	Prior Year 2021-2022	Adopted Budget 2022-2023	CY Estimate 2022-2023	Requested Budget 2023-2024	Recommended Budget 2023-2024	Recommended Change from Adopted
Contributions - Proposition 172	\$3,295,753	\$3,529,729	\$3,529,729	\$4,041,183	4,041,183	\$511,454
Contributions-Other Agencies	\$4,831,337	\$3,238,847	\$1,438,847	\$836,945	836,945	\$(2,401,902)
Trial Courts	\$7,971,665	\$8,937,113	\$7,963,192	\$8,288,269	8,288,269	\$(648,844)
Contingencies	—	\$7,398,322	\$541,260	\$7,933,546	7,933,546	\$535,224
County Memberships	\$81,682	\$81,682	\$81,682	\$85,664	85,664	\$3,982
Medical Care Services	\$3,900,648	\$3,900,648	\$3,900,648	\$3,900,648	3,900,648	—
Other Financing Uses	\$29,617,287	\$49,581,916	\$54,656,532	\$19,144,381	20,632,381	\$(28,949,535)
Other General Expenditures	\$(106,253)	\$288,674	\$288,674	\$200,000	200,000	\$(88,674)
Administration & Finance	\$492,575	\$242,830	\$129,133	\$(491,856)	(491,856)	\$(734,686)
Budget & Analysis	\$1,361,341	\$1,545,814	\$1,530,151	\$1,664,492	1,707,856	\$162,042
Contracts/Purchasing	\$(1,257,709)	\$(740,870)	\$(777,886)	\$(872,666)	(1,043,868)	\$(302,998)
Intergovernmental & Legislative Affairs	\$1,923,592	\$2,957,949	\$3,078,962	\$2,711,401	2,395,032	\$(562,917)
Office of Emergency Services	\$1,784,411	\$2,966,091	\$2,770,623	—	—	\$(2,966,091)
Homeland Security Grant	\$529,162	\$1,645,959	\$1,660,959	—	—	\$(1,645,959)
Office of Community Engagement & Strategic Advocacy	\$826,080	\$810,973	\$825,165	\$679,364	489,364	\$(321,609)
Fleet Administration	\$(169,562)	—	—	—	—	—
Shuttle	\$491	—	—	—	—	—
Auxiliary Services	\$24,131	\$26,144	\$12,000	\$51,125	51,125	\$24,981
Records Retention	\$(151,377)	—	—	—	—	—
Workforce Development Board	\$8,496,290	\$8,681,924	\$8,391,372	\$10,470,579	10,430,579	\$1,748,655
Vehicle Replacement Planning	\$2,330,080	—	—	—	—	—
Rifle Range	\$209,126	—	—	—	—	—
Enterprise Resource Planning	\$(599,082)	\$494,776	\$899,949	\$3,623,974	3,623,974	\$3,129,198
Courier	\$(349,551)	—	—	—	—	—
Mail	\$(131,541)	—	—	—	—	—
Development Set-Aside	\$3,454,664	\$6,231,129	\$3,752,000	\$3,722,000	3,722,000	\$(2,509,129)
Economic Development Administration	\$435,952	\$1,028,523	\$1,052,388	\$631,206	612,206	\$(416,317)
Revolving Loan Program	\$511,873	\$1,150,500	\$1,150,500	\$1,150,500	1,150,500	—
Cannabis	\$956,057	\$2,352,073	\$2,350,735	\$2,989,715	2,989,715	\$637,642
Laguna Seca Track	\$21,769,139	—	—	—	—	—
Building Improvement and Replacement	\$(10,447,078)	\$7,089,250	\$11,368,325	\$(3,412,698)	(2,462,698)	\$(9,551,948)
Emergency Operations Center	\$3,147,200	\$305,000	—	—	—	\$(305,000)
Equipment Replacement	\$(1,274,121)	\$(259,768)	\$(259,768)	\$(501,606)	(501,606)	\$(241,838)
Pension Unfunded Liability	\$45,859	—	\$250,000	\$300,000	300,000	\$300,000
Sustainability	—	—	—	\$2,062,874	1,947,874	\$1,947,874
Subtotal	\$83,510,122	\$113,485,228	\$110,585,172	\$69,209,040	\$70,838,833	\$(42,646,395)

Adopted FY 2022-23 to Recommended FY 2023-24 Positions

Classification Code	Classification Label	Adopted Budget 2021-2022	Adopted Budget 2022-2023	Recommended Budget 2023-2024	Change
11A01	ADMINISTRATIVE OFFICER	1.00	1.00	1.00	0.00
12E01	CHIEF ASSISTANT COUNTY ADMINISTRATIVE OFFICER	0.00	0.00	1.00	1.00
12E03	ASSISTANT COUNTY ADMINISTRATIVE OFFICER	2.00	2.00	1.00	(1.00)
12E16	WIB EXECUTIVE DIRECTOR	1.00	1.00	1.00	0.00
14A23	PRINCIPAL ADMINISTRATIVE ANALYST	5.00	5.00	6.00	1.00
14A24	COUNTY BUDGET DIRECTOR	1.00	1.00	1.00	0.00
14A25	EMERGENCY SERVICES MANAGER	1.00	1.00	0.00	(1.00)
14A28	COUNTY COMMUNICATIONS DIRECTOR	1.00	1.00	1.00	0.00
14C30	MANAGEMENT ANALYST II	5.00	7.00	6.00	(1.00)
14C31	MANAGEMENT ANALYST III	10.00	9.00	10.00	1.00
14C37	COUNTY MEDIA ANALYST	1.00	1.00	1.00	0.00
14E20	BUYER II	2.00	2.00	3.00	1.00
14G02	MANAGEMENT ANALYST I	5.00	2.00	2.00	0.00
14H64	FLEET MANAGER	1.00	0.00	0.00	0.00
14M05	CANNABIS PROGRAM MANAGER	0.00	0.00	1.00	1.00
14M12	ECONOMIC DEVELOPMENT MANAGER	1.00	1.00	1.00	0.00
14M25	COUNTY HOMELESS SERVICES DIRECTOR	0.00	1.00	1.00	0.00
14N05	ADMINISTRATIVE OPERATIONS MANAGER	1.00	0.00	0.00	0.00
14N35	CONTRACTS & PURCHASING OFFICER	1.00	1.00	1.00	0.00
20B10	ACCOUNTANT I	2.00	2.00	0.00	(2.00)
20B11	ACCOUNTANT II	2.00	1.00	2.00	1.00
20B12	ACCOUNTANT III	0.00	0.00	1.00	1.00
20B93	FINANCE MANAGER II	2.00	2.00	2.00	0.00
41G01	EMERGENCY SERVICES PLANNER	4.00	4.00	0.00	(4.00)
43C11	PERMIT TECHNICIAN II	1.00	1.00	1.00	0.00
43J09	SENIOR DEPARTMENTAL INFORMATION SYSTEMS COORDINATOR	1.00	1.00	1.00	0.00
43L18	COMMUNICATIONS TECHNICIAN III	1.00	0.00	0.00	0.00
43L20	COMMUNICATIONS TECHNICIAN I	1.00	0.00	0.00	0.00
60G21	WIB EMPLOYMENT PROGRAMS REPRESENTATIVE II	3.00	3.00	3.00	0.00
60G33	WIB EMPLOYMENT PROGRAMS REPRESENTATIVE III	1.00	1.00	1.00	0.00
60I02	PROGRAM MANAGER II	1.00	1.00	0.00	(1.00)
68A30	RANGE MASTER	1.00	0.00	0.00	0.00
68C02	RANGE AIDE	1.00	0.00	0.00	0.00
70F21	COURIER	4.00	0.00	0.00	0.00
70F23	STOREKEEPER	1.00	0.00	0.00	0.00
70F79	WAREHOUSE WORKER	5.00	1.00	0.00	(1.00)
70F80	SENIOR STOREKEEPER	1.00	0.00	1.00	1.00
70F82	SUPERVISING WAREHOUSE WORKER	1.00	0.00	0.00	0.00
72C20	MECHANIC I	2.00	0.00	0.00	0.00
72C23	MECHANIC II	11.00	0.00	0.00	0.00
72C26	MECHANIC III	2.00	0.00	0.00	0.00
72C83	FLEET SERVICE WRITER	1.00	0.00	0.00	0.00
80A32	SENIOR SECRETARY	3.00	5.00	4.00	(1.00)
80A97	EXECUTIVE ASSISTANT TO ADMINISTRATIVE OFFICER	1.00	1.00	1.00	0.00
80A99	ADMINISTRATIVE SECRETARY-CONFIDENTIAL	2.00	2.00	2.00	0.00
80E01	OFFICE ASSISTANT I	1.00	0.00	0.00	0.00

County Administrative Office

Adopted FY 2022-23 to Recommended FY 2023-24 Positions

Classification Code	Classification Label	Adopted Budget 2021-2022	Adopted Budget 2022-2023	Recommended Budget 2023-2024	Change
80G21	DATA ENTRY OPERATOR II	1.00	0.00	0.00	0.00
80J22	SENIOR ACCOUNT CLERK	2.00	1.00	1.00	0.00
80J30	ACCOUNTING TECHNICIAN	2.00	1.00	1.00	0.00
80O22	MAILROOM CLERK	1.50	0.00	0.00	0.00
80O23	SENIOR MAILROOM CLERK	1.00	0.00	0.00	0.00
99ZXX	ALLOCATION ON LOAN XX	17.00	17.00	17.00	0.00
Total		119.50	80.00	76.00	(4.00)

Augmentation Requests

Request Code	Request Name	Ranking Type Name	Requested Amount	Requested FTE	Recommended Budget	Recommended FTE
1050-8038-001-AUG1	Restore ECD vacant positions	Contribution to Other Funds	115,489	-	115,489	-
1050-8045-001-AUG1	Chief Assistant CAO	Status Quo Vacant Position	51,355	-	51,355	-
1050-8046-001-AUG1	B&A Principal Admin Analyst	ERP Replacement Project Backfill	-	1.00	-	1.00
1050-8047-001-AUG1	C/P Management Analyst II	Request New Position	171,202	1.00	-	-
1050-8047-001-AUG2	Contracts Purchasing Academy	Status Quo Other	25,000	-	25,000	-
1050-8047-001-AUG3	C/P Buyer II	ERP Replacement Project Backfill	-	1.00	-	1.00
1050-8047-001-AUG4	C/P Management Analyst III	ERP Replacement Project Backfill	-	1.00	-	1.00
1050-8054-001-AUG1	IGLA Homeless Management Analyst I	Request New Position	152,835	1.00	-	-
1050-8054-001-AUG2	GLA Homeless Management Analyst II	Request New Position	171,202	1.00	142,668	1.00
1050-8054-001-AUG3	IGLA Homeless Encampment Mitigation Program	New Program/Service w/ General Fund Funding	100,000	-	-	-
1050-8054-001-AUG4	IGLA Media/ Communications Operating Budget	Status Quo Other	235,000	-	200,000	-
1050-8054-001-AUG5	IGLA Legislative Advocacy Contracts	Status Quo Other	103,500	-	103,500	-
1050-8054-001-AUG6	IGLA Homeless Services Operating Budget	Status Quo Other	50,000	-	50,000	-
1050-8440-001-AUG1	Monterey County Violence Prevention Initiative Update	Status Quo Other	190,000	-	-	-
1050-8472-001-AUG1	Cafe & Daycare (Aux Servs) Operating Budget	Status Quo Other	19,852	-	19,852	-
1050-8514-001-AUG1	Econ Dev Association Memberships	New Program/Service w/ General Fund Funding	12,000	-	-	-
1050-8514-001-AUG2	Econ Dev Conferences/Lodging/Travel/Marketing	New Program/Service w/ General Fund Funding	7,000	-	-	-
1050-8514-001-AUG3	Monterey Bay Economic Partnership Membership	Status Quo Other	10,000	-	10,000	-
1050-8514-001-AUG4	ARPA Natl Dev Council Contract	Status Quo Other	75,000	-	75,000	-
1050-8587-001-AUG1	Grant Writing (Regional Climate Proj Work Grp Membership)	Status Quo Other	20,000	-	-	-
1050-8587-001-AUG2	Climate Action Plan (CAP)	Status Quo Other	275,000	-	275,000	-
1050-8587-001-AUG3	Sustainability Operating Budget	Status Quo Other	95,000	-	-	-
1050-8478-021-AUG1	WDB Support Services	Contribution to Other Funds	40,000	-	-	-
Grand Total:			\$1,919,435	6.00	\$1,067,864	4.00

CAO Departmental

Use of Funds

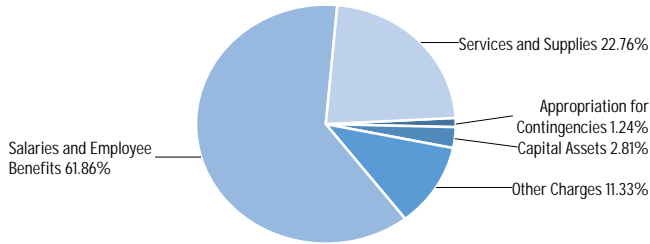

Source of Funds

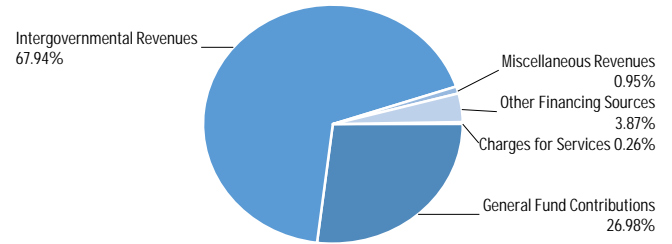

Use of Funds

Expenditures	Prior Year 2021-2022	Adopted Budget 2022-2023	CY Estimate 2022-2023	Requested Budget 2023-2024	Recommended Budget 2023-2024	Recommended Change from Adopted
Salaries and Employee Benefits	\$13,701,324	\$12,190,017	\$11,599,206	\$12,119,568	\$11,776,385	\$(413,632)
Services and Supplies	\$30,389,387	\$4,682,820	\$4,474,019	\$4,757,137	\$4,332,113	\$(350,707)
Other Charges	\$(6,473,787)	\$2,335,921	\$2,322,021	\$2,197,035	\$2,157,035	\$(178,886)
Capital Assets	\$344,151	\$440,149	\$453,997	\$534,969	\$534,969	\$94,820
Other Financing Uses	\$1,283,905	—	—	—	—	—
Appropriation for Contingencies	\$97,536	\$501,400	\$501,400	\$236,400	\$236,400	\$(265,000)
Subtotal	\$39,342,515	\$20,150,307	\$19,350,643	\$19,845,109	\$19,036,902	\$(1,113,405)

Source of Funds

Revenues	Prior Year 2021-2022	Adopted Budget 2022-2023	CY Estimate 2022-2023	Requested Budget 2023-2024	Recommended Budget 2023-2024	Recommended Change from Adopted
Revenue from Use of Money & Property	\$19,181,365	—	—	—	—	—
Intergovernmental Revenues	\$8,885,847	\$9,553,012	\$9,564,018	\$12,932,751	\$12,932,751	\$3,379,739
Charges for Services	\$149,401	\$65,000	\$132,686	\$50,000	\$50,000	\$(15,000)
Miscellaneous Revenues	\$1,391,023	\$142,936	\$292,936	\$181,707	\$181,707	\$38,771
Other Financing Sources	\$607,828	\$711,544	\$711,544	\$736,544	\$736,544	\$25,000
Subtotal	\$30,215,465	\$10,472,492	\$10,701,184	\$13,901,002	\$13,901,002	\$3,428,510
Fund Balance	\$1,075,946	—	\$(290,552)	\$40,000	—	—
General Fund Contributions	\$8,051,104	\$9,677,815	\$8,940,011	\$5,904,107	\$5,135,900	\$(4,541,915)
Total Source of Funds	\$39,342,515	\$20,150,307	\$19,350,643	\$19,845,109	\$19,036,902	\$(1,113,405)

Division Description

The CAO's departmental operations include: Administration and Finance, Budget and Analysis, Contracts-Purchasing, Intergovernmental & Legislative Affairs, Cannabis, the Office of Community Engagement and Strategic Advocacy, Workforce Development Board, Economic Development Administration, and Sustainability.

The responsibilities and programs for each respective unit are discussed in unit narratives following this section.

Summary of Recommendation

The FY 2023-24 Recommended Budget for the CAO's departmental operations is \$19,036,902, a decrease of \$1,113,405 from the prior year adopted budget. The decrease is mainly attributed to the reorganization of the Department of Emergency Management and increased departmental cost plan recoveries. Cost plan recoveries are treated as expenditure offsets; increases in recoveries, therefore, decrease expenditures. Partially offsetting these reductions includes increases attributed to expenses financed by grant revenues in Cannabis and Sustainability.

Appropriation Expenditure Detail

	Prior Year 2021-2022	Adopted Budget 2022-2023	CY Estimate 2022-2023	Requested Budget 2023-2024	Recommended Budget 2023-2024	Recommended Change from Adopted	Fund Code	Budget Unit Code
Administration & Finance (CA0001)	492,575	242,830	129,133	(491,856)	(491,856)	(734,686)	001	8045
Budget & Analysis (CA0001)	1,361,341	1,545,814	1,530,151	1,664,492	1,707,856	162,042	001	8046
Contracts/Purchasing (CA0002)	(1,257,709)	(740,870)	(777,886)	(872,666)	(1,043,868)	(302,998)	001	8047
Intergovernmental & Legislative Affairs (CA0004)	1,923,592	2,957,949	3,078,962	2,711,401	2,395,032	(562,917)	001	8054
Office of Emergency Services (CA0005)	1,784,411	2,966,091	2,770,623	0	0	(2,966,091)	001	8056
Office of Community Engagement & Strategic Advocacy (CA0024)	826,080	810,973	825,165	679,364	489,364	(321,609)	001	8440
Fleet Administration (CA0025)	(169,562)	0	0	0	0	0	001	8451
Shuttle (CA0025)	491	0	0	0	0	0	001	8452
Records Retention (CA0028)	(151,377)	0	0	0	0	0	001	8474
Workforce Development Board (CA0030)	8,496,290	8,681,924	8,391,372	10,470,579	10,430,579	1,748,655	021	8478
Rifle Range (CA0029)	209,126	0	0	0	0	0	001	8504
Courier (CA0035)	(349,551)	0	0	0	0	0	001	8508
Mail (CA0035)	(131,541)	0	0	0	0	0	001	8509
Economic Development Administration (CA0038)	435,952	1,028,523	1,052,388	631,206	612,206	(416,317)	001	8514
Cannabis (CA0004)	956,057	2,352,073	2,350,735	2,989,715	2,989,715	637,642	001	8533
Laguna Seca Track (CA0046)	21,769,139	0	0	0	0	0	453	8536
Emergency Operations Center (CA0005)	3,147,200	305,000	0	0	0	(305,000)	001	8541
Sustainability (CA0004)	0	0	0	2,062,874	1,947,874	1,947,874	001	8587
Subtotal	\$39,342,515	\$20,150,307	\$19,350,643	\$19,845,109	\$19,036,902	\$(1,113,405)		

Administration & Finance

(Budget Unit 8045—Fund 001—Appropriation Unit CAO001)

Use of Funds

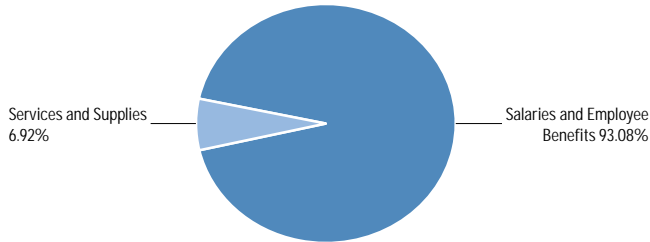

Source of Funds

Intentionally Left Blank

Use of Funds

Expenditures	Prior Year 2021-2022	Adopted Budget 2022-2023	CY Estimate 2022-2023	Requested Budget 2023-2024	Recommended Budget 2023-2024	Recommended Change from Adopted
Salaries and Employee Benefits	\$1,727,367	\$2,141,068	\$2,042,704	\$2,166,351	\$2,166,351	\$25,283
Services and Supplies	\$135,651	\$163,979	\$146,484	\$161,135	\$161,135	\$(2,844)
Other Charges	\$(1,372,430)	\$(2,062,217)	\$(2,062,217)	\$(2,819,342)	\$(2,819,342)	\$(757,125)
Capital Assets	\$1,988	—	\$2,162	—	—	—
Subtotal	\$492,575	\$242,830	\$129,133	\$(491,856)	\$(491,856)	\$(734,686)

Source of Funds

Revenues	Prior Year 2021-2022	Adopted Budget 2022-2023	CY Estimate 2022-2023	Requested Budget 2023-2024	Recommended Budget 2023-2024	Recommended Change from Adopted
General Fund Contributions	\$492,575	\$242,830	\$129,133	\$(491,856)	\$(491,856)	\$(734,686)
Total Source of Funds	\$492,575	\$242,830	\$129,133	\$(491,856)	\$(491,856)	\$(734,686)

Unit Description

The Administration and Finance unit consists of countywide executive management and staff for fiscal/financial support to all divisions within the CAO, the Board of Supervisors (BOS), and Clerk of the Board. Daily departmental support includes payroll, accounts payable, accounts receivable, purchase requisitions, expense reimbursements, cost accounting, fiscal grant management, and related interactions with the Auditor-Controller’s Office. CAO provides support to Board of Supervisors’ district offices in the development of their annual budget requests and budget maintenance throughout the fiscal year.

Recommended FY 2023-24 Positions

Classification Code	Classification Label	FTE
11A01	ADMINISTRATIVE OFFICER	1.00
12E01	CHIEF ASSISTANT COUNTY ADMINISTRATIVE OFFICER	1.00
14C31	MANAGEMENT ANALYST III	1.00
20B11	ACCOUNTANT II	1.00
20B12	ACCOUNTANT III	1.00
20B93	FINANCE MANAGER II	1.00
80A32	SENIOR SECRETARY	1.00
80A97	EXECUTIVE ASSISTANT TO ADMINISTRATIVE OFFICER	1.00
80A99	ADMINISTRATIVE SECRETARY-CONFIDENTIAL	1.00
80J22	SENIOR ACCOUNT CLERK	1.00
80J30	ACCOUNTING TECHNICIAN	1.00
99ZXX	ALLOCATION ON LOAN XX	17.00
Total		28.00

Budget & Analysis

(Budget Unit 8046—Fund 001—Appropriation Unit CA0001)

Use of Funds

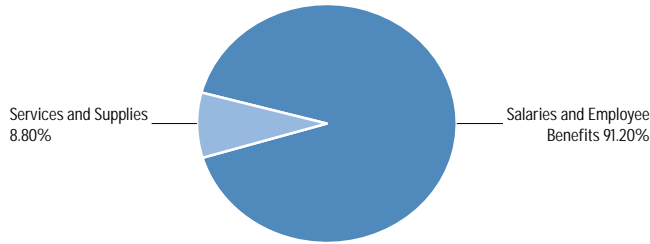

Source of Funds

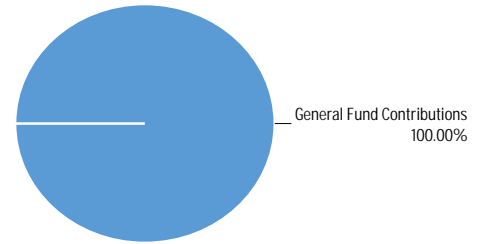

Use of Funds

Expenditures	Prior Year 2021-2022	Adopted Budget 2022-2023	CY Estimate 2022-2023	Requested Budget 2023-2024	Recommended Budget 2023-2024	Recommended Change from Adopted
Salaries and Employee Benefits	\$1,314,010	\$1,447,843	\$1,445,121	\$1,775,570	\$1,775,570	\$327,727
Services and Supplies	\$47,243	\$118,998	\$105,114	\$127,893	\$171,257	\$52,259
Other Charges	\$(822)	\$(21,027)	\$(21,027)	\$(238,971)	\$(238,971)	\$(217,944)
Capital Assets	\$910	—	\$943	—	—	—
Subtotal	\$1,361,341	\$1,545,814	\$1,530,151	\$1,664,492	\$1,707,856	\$162,042

Source of Funds

Revenues	Prior Year 2021-2022	Adopted Budget 2022-2023	CY Estimate 2022-2023	Requested Budget 2023-2024	Recommended Budget 2023-2024	Recommended Change from Adopted
Intergovernmental Revenues	\$13,532	\$46,695	\$57,701	—	—	\$(46,695)
Subtotal	\$13,532	\$46,695	\$57,701	—	—	\$(46,695)
General Fund Contributions	\$1,347,809	\$1,499,119	\$1,472,450	\$1,664,492	\$1,707,856	\$208,737
Total Source of Funds	\$1,361,341	\$1,545,814	\$1,530,151	\$1,664,492	\$1,707,856	\$162,042

Unit Description

The Budget and Analysis Division develops and presents the County's annual Recommended Budget, aligning recommendations with the adopted goals, policies, and priorities of the BOS. The Division also prepares the annual Three-Year Financial Forecast, Budget End of Year Report, and other financial analysis products such as reports providing analysis and recommendations for solving mid-year unfunded needs. Other responsibilities include: analyzing weekly Board meeting agenda items to ensure transparency and that recommendations are consistent with Board policy; working with County departments to monitor performance in meeting countywide goals and priorities; providing advisory assistance and analysis to departments on recommendations for new or changing organizational

programs, systems, policies and procedures; and evaluating organizational improvements to maximize countywide service delivery and efficiencies. In addition, the Budget and Analysis Division coordinates and provides professional staff support to the Board's Budget Committee and Capital Improvement Committee.

Recommended FY 2023-24 Positions

Classification Code	Classification Label	FTE
14A23	PRINCIPAL ADMINISTRATIVE ANALYST	6.00
14A24	COUNTY BUDGET DIRECTOR	1.00
Total		7.00

Contracts/Purchasing

(Budget Unit 8047—Fund 001—Appropriation Unit CAO002)

Use of Funds

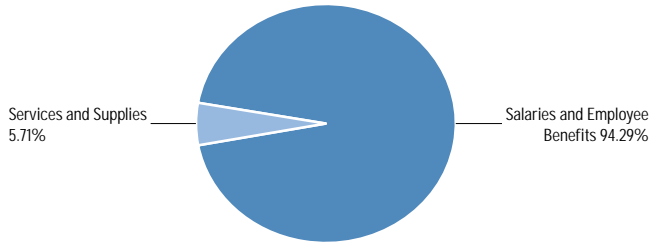

Source of Funds

Intentionally Left Blank

Use of Funds

Expenditures	Prior Year 2021-2022	Adopted Budget 2022-2023	CY Estimate 2022-2023	Requested Budget 2023-2024	Recommended Budget 2023-2024	Recommended Change from Adopted
Salaries and Employee Benefits	\$1,119,460	\$1,263,728	\$1,265,329	\$1,814,219	\$1,647,711	\$383,983
Services and Supplies	\$247,533	\$100,929	\$54,986	\$104,395	\$99,701	\$(1,228)
Other Charges	\$(2,631,585)	\$(2,105,527)	\$(2,105,110)	\$(2,791,280)	\$(2,791,280)	\$(685,753)
Capital Assets	\$6,883	—	\$6,909	—	—	—
Subtotal	\$(1,257,709)	\$(740,870)	\$(777,886)	\$(872,666)	\$(1,043,868)	\$(302,998)

Source of Funds

Revenues	Prior Year 2021-2022	Adopted Budget 2022-2023	CY Estimate 2022-2023	Requested Budget 2023-2024	Recommended Budget 2023-2024	Recommended Change from Adopted
Miscellaneous Revenues	\$10	—	—	—	—	—
Subtotal	\$10	—	—	—	—	—
General Fund Contributions	\$(1,257,719)	\$(740,870)	\$(777,886)	\$(872,666)	\$(1,043,868)	\$(302,998)
Total Source of Funds	\$(1,257,709)	\$(740,870)	\$(777,886)	\$(872,666)	\$(1,043,868)	\$(302,998)

Unit Description

The Contracts and Purchasing Division provides County departments with knowledgeable assistance in the procurement of services, goods and general management of contract-related issues. The division's services include, but are not limited to; developing and coordinating competitive bid processes (Request for Proposals and Request for Qualifications); Countywide oversight of contract management; management and oversight of the County Procurement Card program; management of the County Surplus Program and Personal Protective Equipment (PPE) distribution; maintains the County Contracts & Purchasing Academy; management and oversight of the County Cafe's and Daycare leases; operates and functions as the expert

Logistics Section in the Emergency Operation Center during an activation.

Recommended FY 2023-24 Positions

Classification Code	Classification Label	FTE
14C30	MANAGEMENT ANALYST II	1.00
14C31	MANAGEMENT ANALYST III	3.00
14E20	BUYER II	3.00
14G02	MANAGEMENT ANALYST I	1.00
14N35	CONTRACTS & PURCHASING OFFICER	1.00
70F80	SENIOR STOREKEEPER	1.00
Total		10.00

Intergovernmental & Legislative Affairs

(Budget Unit 8054—Fund 001—Appropriation Unit CAO004)

Use of Funds

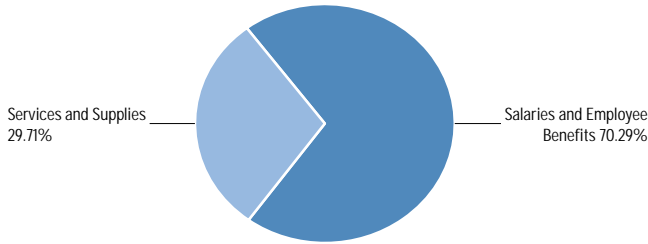

Source of Funds

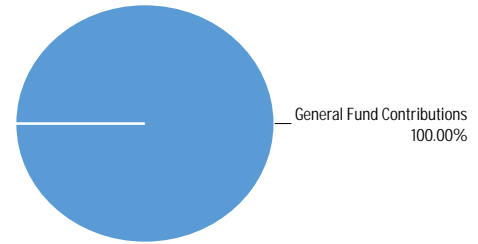

Use of Funds

Expenditures	Prior Year 2021-2022	Adopted Budget 2022-2023	CY Estimate 2022-2023	Requested Budget 2023-2024	Recommended Budget 2023-2024	Recommended Change from Adopted
Salaries and Employee Benefits	\$1,094,813	\$1,774,652	\$1,736,111	\$1,860,251	\$1,683,576	\$(91,076)
Services and Supplies	\$828,021	\$1,183,297	\$1,342,065	\$851,150	\$711,456	\$(471,841)
Capital Assets	\$759	—	\$786	—	—	—
Subtotal	\$1,923,592	\$2,957,949	\$3,078,962	\$2,711,401	\$2,395,032	\$(562,917)

Source of Funds

Revenues	Prior Year 2021-2022	Adopted Budget 2022-2023	CY Estimate 2022-2023	Requested Budget 2023-2024	Recommended Budget 2023-2024	Recommended Change from Adopted
Intergovernmental Revenues	—	\$100,000	\$100,000	—	—	\$(100,000)
Miscellaneous Revenues	\$20,000	—	\$150,000	—	—	—
Subtotal	\$20,000	\$100,000	\$250,000	—	—	\$(100,000)
General Fund Contributions	\$1,903,592	\$2,857,949	\$2,828,962	\$2,711,401	\$2,395,032	\$(462,917)
Total Source of Funds	\$1,923,592	\$2,957,949	\$3,078,962	\$2,711,401	\$2,395,032	\$(562,917)

Unit Description

The Intergovernmental and Legislative Affairs (IGLA) Division's responsibilities include the Board's Strategic Initiatives and Key Objectives; the annual Board/department head strategic planning sessions; cannabis program; sustainability program; legislative coordination and advocacy; workforce development; community engagement; communications/public information/media relations and government channel programming; strategic grant services and coordination of homeless services. IGLA staffs the following Board of Supervisors standing committees: Legislative Committee, Cannabis Committee; Health, Human Services and Housing Committee; Workforce Development Board, Homelessness and the Alternate Energy and Environment Committee. IGLA also staffs the Board's ad hoc committee on Covid-19 communications. The Division's Assistant CAO is the Administrative Office liaison to various County departments including the Housing and Community Development, Agricultural Commissioner, Emergency Communications and the Department of Emergency Management.

The IGLA Division staff also undertakes a wide array of special projects as assigned by the CAO.

Recommended FY 2023-24 Positions

Classification Code	Classification Label	FTE
12E03	ASSISTANT COUNTY ADMINISTRATIVE OFFICER	1.00
14A28	COUNTY COMMUNICATIONS DIRECTOR	1.00
14C30	MANAGEMENT ANALYST II	1.00
14C31	MANAGEMENT ANALYST III	2.00
14C37	COUNTY MEDIA ANALYST	1.00
14M25	COUNTY HOMELESS SERVICES DIRECTOR	1.00
80A32	SENIOR SECRETARY	1.00
80A99	ADMINISTRATIVE SECRETARY-CONFIDENTIAL	1.00
Total		9.00

Cannabis

(Budget Unit 8533—Fund 001—Appropriation Unit CAO004)

Use of Funds

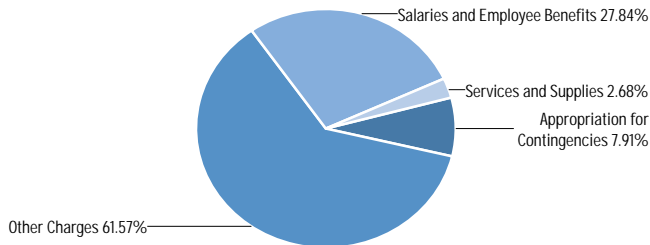

Source of Funds

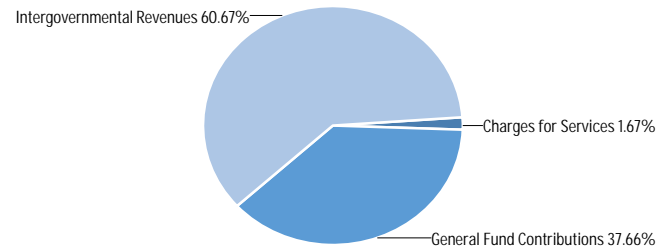

Use of Funds

Expenditures	Prior Year 2021-2022	Adopted Budget 2022-2023	CY Estimate 2022-2023	Requested Budget 2023-2024	Recommended Budget 2023-2024	Recommended Change from Adopted
Salaries and Employee Benefits	\$741,025	\$777,466	\$817,570	\$832,225	\$832,225	\$54,759
Services and Supplies	\$113,246	\$79,187	\$36,089	\$80,222	\$80,222	\$1,035
Other Charges	—	\$994,020	\$994,020	\$1,840,868	\$1,840,868	\$846,848
Capital Assets	\$4,251	—	\$1,656	—	—	—
Appropriation for Contingencies	\$97,536	\$501,400	\$501,400	\$236,400	\$236,400	\$(265,000)
Subtotal	\$956,057	\$2,352,073	\$2,350,735	\$2,989,715	\$2,989,715	\$637,642

Source of Funds

Revenues	Prior Year 2021-2022	Adopted Budget 2022-2023	CY Estimate 2022-2023	Requested Budget 2023-2024	Recommended Budget 2023-2024	Recommended Change from Adopted
Intergovernmental Revenues	\$14,572	\$976,251	\$976,251	\$1,813,758	\$1,813,758	\$837,507
Charges for Services	\$80,131	\$65,000	\$65,000	\$50,000	\$50,000	\$(15,000)
Subtotal	\$94,703	\$1,041,251	\$1,041,251	\$1,863,758	\$1,863,758	\$822,507
General Fund Contributions	\$861,354	\$1,310,822	\$1,309,484	\$1,125,957	\$1,125,957	\$(184,865)
Total Source of Funds	\$956,057	\$2,352,073	\$2,350,735	\$2,989,715	\$2,989,715	\$637,642

Unit Description

The Cannabis Program is the local regulatory agency that manages the Cannabis Business Permit, oversight and coordination of the cannabis compliance inspection process between the Environmental Health Bureau, Housing and Community Development and local Fire agencies to ensure operator compliance; coordination of the seven other County departments to collaborate and share information related to permits, licenses, and other requirements; management of cannabis-related grants pertaining to equity, enforcement, and public outreach; and serving as ombudsperson to assist the industry in navigating County processes and requirements. Additional Cannabis Program responsibilities include implementation of the Strategic Plan, monitoring and updating the Board of Supervisors with the balance of the cannabis assignment, permit/license statuses, resource utilization of the eight participating departments, and cannabis tax revenue

collection outcomes. The Cannabis Program is in a unique position that requires County leadership to be adaptive when addressing emergent issues to ensure the sustainability of this new cannabis industry within Monterey County, which is yet to stabilize across the state and nation.

Recommended FY 2023-24 Positions

Classification Code	Classification Label	FTE
14C30	MANAGEMENT ANALYST II	1.00
14C31	MANAGEMENT ANALYST III	1.00
14M05	CANNABIS PROGRAM MANAGER	1.00
43C11	PERMIT TECHNICIAN II	1.00
80A32	SENIOR SECRETARY	1.00
Total		5.00

Sustainability

(Budget Unit 8587—Fund 001—Appropriation Unit CA0004)

Use of Funds

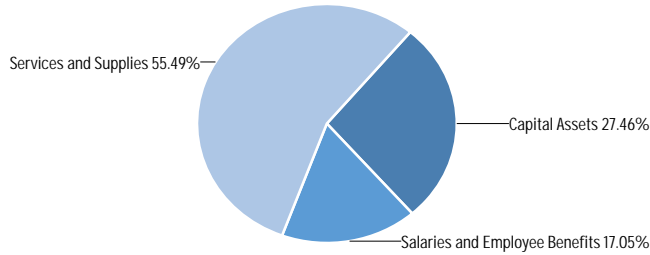

Source of Funds

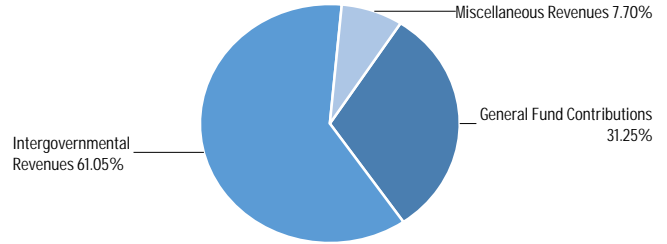

Use of Funds

Expenditures	Prior Year 2021-2022	Adopted Budget 2022-2023	CY Estimate 2022-2023	Requested Budget 2023-2024	Recommended Budget 2023-2024	Recommended Change from Adopted
Salaries and Employee Benefits	—	—	—	\$332,050	\$332,050	\$332,050
Services and Supplies	—	—	—	\$1,195,855	\$1,080,855	\$1,080,855
Capital Assets	—	—	—	\$534,969	\$534,969	\$534,969
Subtotal	—	—	—	\$2,062,874	\$1,947,874	\$1,947,874

Source of Funds

Revenues	Prior Year 2021-2022	Adopted Budget 2022-2023	CY Estimate 2022-2023	Requested Budget 2023-2024	Recommended Budget 2023-2024	Recommended Change from Adopted
Intergovernmental Revenues	—	—	—	\$1,189,164	\$1,189,164	\$1,189,164
Miscellaneous Revenues	—	—	—	\$150,000	\$150,000	\$150,000
Subtotal	—	—	—	\$1,339,164	\$1,339,164	\$1,339,164
General Fund Contributions	—	—	—	\$723,710	\$608,710	\$608,710
Total Source of Funds	—	—	—	\$2,062,874	\$1,947,874	\$1,947,874

Unit Description

The Sustainability Program manages projects and programs ensuring compliance with State law and local regulations related to greenhouse gas emissions and sustainable energy. The Program develops and implements the Community Climate Action Plan and the Municipal Climate Action Plan. These plans contain strategies for reducing emissions from greenhouse gases internally within County government operations as well as externally countywide through the development of policies and local regulations. The Program staffs the Board of Supervisors Alternate Energy and Environment Committee and develops policies and regulations regarding sustainability for

consideration by the Board of Supervisors. In addition, the Program recommends sustainable infrastructure projects to County departments and applies for, manages and implements energy-related grants.

Recommended FY 2023-24 Positions

Classification Code	Classification Label	FTE
14C31	MANAGEMENT ANALYST III	1.00
14G02	MANAGEMENT ANALYST I	1.00
Total		2.00

Office of Emergency Services

(Budget Unit 8056—Fund 001—Appropriation Unit CAO005)

Use of Funds	Source of Funds
Intentionally Left Blank	Intentionally Left Blank

Use of Funds

Expenditures	Prior Year 2021-2022	Adopted Budget 2022-2023	CY Estimate 2022-2023	Requested Budget 2023-2024	Recommended Budget 2023-2024	Recommended Change from Adopted
Salaries and Employee Benefits	\$981,103	\$1,549,120	\$1,321,654	—	—	\$(1,549,120)
Services and Supplies	\$170,154	\$434,071	\$464,455	—	—	\$(434,071)
Other Charges	\$551,806	\$542,751	\$543,288	—	—	\$(542,751)
Capital Assets	\$81,349	\$440,149	\$441,226	—	—	\$(440,149)
Subtotal	\$1,784,411	\$2,966,091	\$2,770,623	—	—	\$(2,966,091)

Source of Funds

Revenues	Prior Year 2021-2022	Adopted Budget 2022-2023	CY Estimate 2022-2023	Requested Budget 2023-2024	Recommended Budget 2023-2024	Recommended Change from Adopted
Intergovernmental Revenues	\$108,996	\$214,452	\$214,452	—	—	\$(214,452)
Charges for Services	—	—	\$67,686	—	—	—
Subtotal	\$108,996	\$214,452	\$282,138	—	—	\$(214,452)
General Fund Contributions	\$1,675,415	\$2,751,639	\$2,488,485	—	—	\$(2,751,639)
Total Source of Funds	\$1,784,411	\$2,966,091	\$2,770,623	—	—	\$(2,966,091)

Unit Description

Beginning in FY 2023-24 this unit was moved to its own department.

Office of Community Engagement & Strategic Advocacy

(Budget Unit 8440—Fund 001—Appropriation Unit CAO024)

Use of Funds

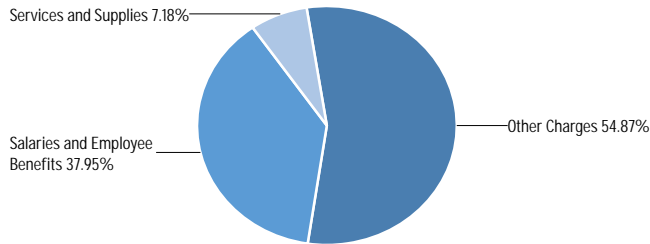

Source of Funds

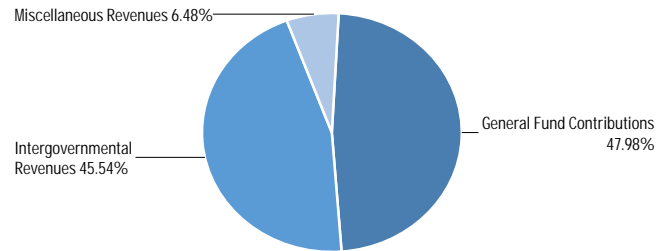

Use of Funds

Expenditures	Prior Year 2021-2022	Adopted Budget 2022-2023	CY Estimate 2022-2023	Requested Budget 2023-2024	Recommended Budget 2023-2024	Recommended Change from Adopted
Salaries and Employee Benefits	\$192,763	\$184,410	\$218,457	\$185,703	\$185,703	\$1,293
Services and Supplies	\$350,887	\$225,533	\$220,217	\$225,155	\$35,155	\$(190,378)
Other Charges	\$282,127	\$401,030	\$386,176	\$268,506	\$268,506	\$(132,524)
Capital Assets	\$303	—	\$315	—	—	—
Subtotal	\$826,080	\$810,973	\$825,165	\$679,364	\$489,364	\$(321,609)

Source of Funds

Revenues	Prior Year 2021-2022	Adopted Budget 2022-2023	CY Estimate 2022-2023	Requested Budget 2023-2024	Recommended Budget 2023-2024	Recommended Change from Adopted
Intergovernmental Revenues	\$245,234	\$245,234	\$245,234	\$222,870	\$222,870	\$(22,364)
Miscellaneous Revenues	\$44,496	\$142,936	\$142,936	\$31,707	\$31,707	\$(111,229)
Subtotal	\$289,730	\$388,170	\$388,170	\$254,577	\$254,577	\$(133,593)
General Fund Contributions	\$536,350	\$422,803	\$436,995	\$424,787	\$234,787	\$(188,016)
Total Source of Funds	\$826,080	\$810,973	\$825,165	\$679,364	\$489,364	\$(321,609)

Unit Description

The Office of Community Engagement & Strategic Advocacy (OCESA) provides management capacity and community engagement support to the Board of Supervisors and County departments. A key role of this program is to develop and implement measures to communicate County programs and priorities to the full range of the community, particularly those historically underserved segments. Another key function of the program is communicating community priorities and key issues to the County government structure. The program is also responsible for the Monterey County

Gang Violence Prevention Initiative, a strategic priority adopted by the BOS in May 2013, which implements a framework of collaboration among stakeholders and engages the public at large. The program functions as staff for the Health, Housing, and Human Services Committee of the Board of Supervisors.

Recommended FY 2023-24 Positions

Classification Code	Classification Label	FTE
14C31	MANAGEMENT ANALYST III	1.00
Total		1.00

Fleet Administration

(Budget Unit 8451—Fund 001—Appropriation Unit CAO025)

Use of Funds	Source of Funds
Intentionally Left Blank	Intentionally Left Blank

Use of Funds						
Expenditures	Prior Year 2021-2022	Adopted Budget 2022-2023	CY Estimate 2022-2023	Requested Budget 2023-2024	Recommended Budget 2023-2024	Recommended Change from Adopted
Salaries and Employee Benefits	\$2,831,576	—	—	—	—	—
Services and Supplies	\$4,533,899	—	—	—	—	—
Other Charges	\$(7,608,756)	—	—	—	—	—
Capital Assets	\$73,720	—	—	—	—	—
Subtotal	\$(169,562)	—	—	—	—	—

Source of Funds						
Revenues	Prior Year 2021-2022	Adopted Budget 2022-2023	CY Estimate 2022-2023	Requested Budget 2023-2024	Recommended Budget 2023-2024	Recommended Change from Adopted
Charges for Services	\$69,270	—	—	—	—	—
Miscellaneous Revenues	\$1,935	—	—	—	—	—
Other Financing Sources	\$3,250	—	—	—	—	—
Subtotal	\$74,455	—	—	—	—	—
General Fund Contributions	\$(244,017)	—	—	—	—	—
Total Source of Funds	\$(169,562)	—	—	—	—	—

Unit Description

Beginning in FY 2022-23 this unit transferred to Public Works Facilities and Parks.

Shuttle

(Budget Unit 8452—Fund 001—Appropriation Unit CA0025)

Use of Funds

Intentionally Left Blank

Source of Funds

Intentionally Left Blank

Use of Funds

Expenditures	Prior Year 2021-2022	Adopted Budget 2022-2023	CY Estimate 2022-2023	Requested Budget 2023-2024	Recommended Budget 2023-2024	Recommended Change from Adopted
Services and Supplies	\$491	—	—	—	—	—
Subtotal	\$491	—	—	—	—	—

Source of Funds

Revenues	Prior Year 2021-2022	Adopted Budget 2022-2023	CY Estimate 2022-2023	Requested Budget 2023-2024	Recommended Budget 2023-2024	Recommended Change from Adopted
General Fund Contributions	\$491	—	—	—	—	—
Total Source of Funds	\$491	—	—	—	—	—

Unit Description

Beginning in FY 2022-23 this unit transferred to Public Works Facilities and Parks.

Records Retention

(Budget Unit 8474—Fund 001—Appropriation Unit CAO028)

Use of Funds

Intentionally Left Blank

Source of Funds

Intentionally Left Blank

Use of Funds

Expenditures	Prior Year 2021-2022	Adopted Budget 2022-2023	CY Estimate 2022-2023	Requested Budget 2023-2024	Recommended Budget 2023-2024	Recommended Change from Adopted
Salaries and Employee Benefits	\$510,574	—	—	—	—	—
Services and Supplies	\$138,803	—	—	—	—	—
Other Charges	\$(815,609)	—	—	—	—	—
Capital Assets	\$14,855	—	—	—	—	—
Subtotal	\$(151,377)	—	—	—	—	—

Source of Funds

Revenues	Prior Year 2021-2022	Adopted Budget 2022-2023	CY Estimate 2022-2023	Requested Budget 2023-2024	Recommended Budget 2023-2024	Recommended Change from Adopted
General Fund Contributions	\$(151,377)	—	—	—	—	—
Total Source of Funds	\$(151,377)	—	—	—	—	—

Unit Description

Beginning in FY 2022-23 this unit was transferred to Public Works Facilities and Parks.

Workforce Development Board

(Budget Unit 8478—Fund 021—Appropriation Unit CAO030)

Use of Funds

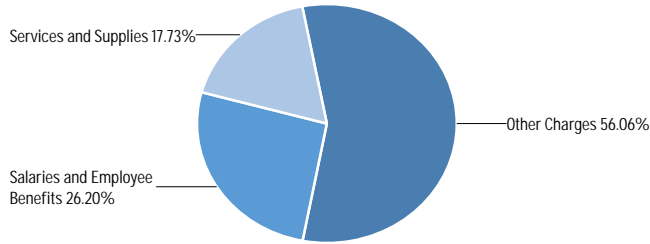

Source of Funds

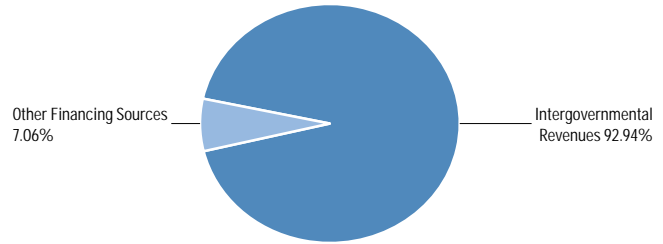

Use of Funds

Expenditures	Prior Year 2021-2022	Adopted Budget 2022-2023	CY Estimate 2022-2023	Requested Budget 2023-2024	Recommended Budget 2023-2024	Recommended Change from Adopted
Salaries and Employee Benefits	\$2,017,838	\$2,651,154	\$2,374,770	\$2,733,217	\$2,733,217	\$82,063
Services and Supplies	\$1,546,334	\$1,934,742	\$1,920,574	\$1,849,837	\$1,849,837	\$(84,905)
Other Charges	\$4,932,118	\$4,096,028	\$4,096,028	\$5,887,525	\$5,847,525	\$1,751,497
Subtotal	\$8,496,290	\$8,681,924	\$8,391,372	\$10,470,579	\$10,430,579	\$1,748,655

Source of Funds

Revenues	Prior Year 2021-2022	Adopted Budget 2022-2023	CY Estimate 2022-2023	Requested Budget 2023-2024	Recommended Budget 2023-2024	Recommended Change from Adopted
Revenue from Use of Money & Property	\$(409)	—	—	—	—	—
Intergovernmental Revenues	\$8,213,174	\$7,970,380	\$7,970,380	\$9,694,035	\$9,694,035	\$1,723,655
Miscellaneous Revenues	\$96,100	—	—	—	—	—
Other Financing Sources	\$596,728	\$711,544	\$711,544	\$736,544	\$736,544	\$25,000
Subtotal	\$8,905,593	\$8,681,924	\$8,681,924	\$10,430,579	\$10,430,579	\$1,748,655
Fund Balance	\$(409,303)	—	\$(290,552)	\$40,000	—	—
Total Source of Funds	\$8,496,290	\$8,681,924	\$8,391,372	\$10,470,579	\$10,430,579	\$1,748,655

Unit Description

The Monterey County Workforce Development Board (WDB) was established through the Workforce Investment Act (WIA) in 1998 and superseded by the Workforce Innovation and Opportunity Act (WIOA) on July 22, 2014. The WDB includes business and community leaders that represent one of the five Monterey County Board of Supervisors' districts, representing a strong alignment of business, labor, education, economic development, community based and youth-serving organizations, and mandated partners such as the California Employment Development Department Wagner-Peyser program, and California Department Vocational Rehabilitation Services.

The WDB oversees three Career Centers located in Salinas, Marina and Greenfield to ensure the residents have the skills, training, and education to achieve career goals and where employers can hire, train and retain qualified employees.

Recommended FY 2023-24 Positions

Classification Code	Classification Label	FTE
12E16	WIB EXECUTIVE DIRECTOR	1.00
14C30	MANAGEMENT ANALYST II	2.00
14C31	MANAGEMENT ANALYST III	1.00
20B11	ACCOUNTANT II	1.00
20B93	FINANCE MANAGER II	1.00
43J09	SENIOR DEPARTMENTAL INFORMATION SYSTEMS COORDINATOR	1.00
60G21	WIB EMPLOYMENT PROGRAMS REPRESENTATIVE II	3.00
60G33	WIB EMPLOYMENT PROGRAMS REPRESENTATIVE III	1.00
80A32	SENIOR SECRETARY	1.00
Total		12.00

Rifle Range

(Budget Unit 8504—Fund 001—Appropriation Unit CAO029)

Use of Funds

Intentionally Left Blank

Source of Funds

Intentionally Left Blank

Use of Funds

Expenditures	Prior Year 2021-2022	Adopted Budget 2022-2023	CY Estimate 2022-2023	Requested Budget 2023-2024	Recommended Budget 2023-2024	Recommended Change from Adopted
Salaries and Employee Benefits	\$156,382	—	—	—	—	—
Services and Supplies	\$46,043	—	—	—	—	—
Other Charges	\$6,701	—	—	—	—	—
Subtotal	\$209,126	—	—	—	—	—

Source of Funds

Revenues	Prior Year 2021-2022	Adopted Budget 2022-2023	CY Estimate 2022-2023	Requested Budget 2023-2024	Recommended Budget 2023-2024	Recommended Change from Adopted
Revenue from Use of Money & Property	\$134,217	—	—	—	—	—
Subtotal	\$134,217	—	—	—	—	—
General Fund Contributions	\$74,909	—	—	—	—	—
Total Source of Funds	\$209,126	—	—	—	—	—

Unit Description

Beginning in FY 2022-23 this unit was transferred to Public Works Facilities and Parks.

Courier

(Budget Unit 8508—Fund 001—Appropriation Unit CAO035)

Use of Funds

Source of Funds

Intentionally Left Blank

Intentionally Left Blank

Use of Funds

Expenditures	Prior Year 2021-2022	Adopted Budget 2022-2023	CY Estimate 2022-2023	Requested Budget 2023-2024	Recommended Budget 2023-2024	Recommended Change from Adopted
Salaries and Employee Benefits	\$367,699	—	—	—	—	—
Services and Supplies	\$58,006	—	—	—	—	—
Other Charges	\$(775,256)	—	—	—	—	—
Subtotal	\$(349,551)	—	—	—	—	—

Source of Funds

Revenues	Prior Year 2021-2022	Adopted Budget 2022-2023	CY Estimate 2022-2023	Requested Budget 2023-2024	Recommended Budget 2023-2024	Recommended Change from Adopted
General Fund Contributions	\$(349,551)	—	—	—	—	—
Total Source of Funds	\$(349,551)	—	—	—	—	—

Unit Description

Beginning in FY 2022-23 this unit was moved to Public Works Facilities and Parks.

Mail

(Budget Unit 8509—Fund 001—Appropriation Unit CAO035)

Use of Funds	Source of Funds
Intentionally Left Blank	Intentionally Left Blank

Use of Funds	Prior Year 2021-2022	Adopted Budget 2022-2023	CY Estimate 2022-2023	Requested Budget 2023-2024	Recommended Budget 2023-2024	Recommended Change from Adopted
Expenditures						
Salaries and Employee Benefits	\$86,448	—	—	—	—	—
Services and Supplies	\$72,322	—	—	—	—	—
Other Charges	\$(332,387)	—	—	—	—	—
Capital Assets	\$42,076	—	—	—	—	—
Subtotal	\$(131,541)	—	—	—	—	—

Source of Funds	Prior Year 2021-2022	Adopted Budget 2022-2023	CY Estimate 2022-2023	Requested Budget 2023-2024	Recommended Budget 2023-2024	Recommended Change from Adopted
Revenues						
General Fund Contributions	\$(131,541)	—	—	—	—	—
Total Source of Funds	\$(131,541)	—	—	—	—	—

Unit Description

Beginning in FY 2022-23 this unit was transferred to Public Works Facilities and Parks.

Economic Development Administration

(Budget Unit 8514—Fund 001—Appropriation Unit CA0038)

Use of Funds

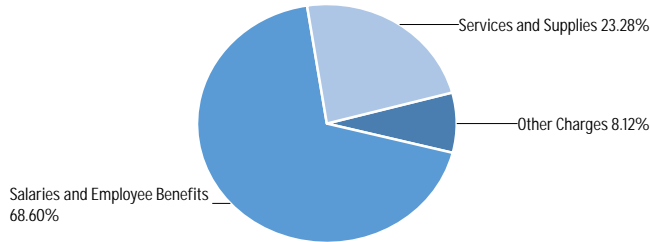

Source of Funds

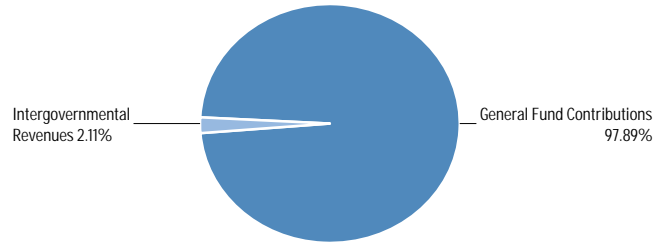

Use of Funds

Expenditures	Prior Year 2021-2022	Adopted Budget 2022-2023	CY Estimate 2022-2023	Requested Budget 2023-2024	Recommended Budget 2023-2024	Recommended Change from Adopted
Salaries and Employee Benefits	\$225,249	\$400,576	\$377,490	\$419,982	\$419,982	\$19,406
Services and Supplies	\$111,806	\$137,084	\$184,035	\$161,495	\$142,495	\$5,411
Other Charges	\$98,897	\$490,863	\$490,863	\$49,729	\$49,729	\$(441,134)
Subtotal	\$435,952	\$1,028,523	\$1,052,388	\$631,206	\$612,206	\$(416,317)

Source of Funds

Revenues	Prior Year 2021-2022	Adopted Budget 2022-2023	CY Estimate 2022-2023	Requested Budget 2023-2024	Recommended Budget 2023-2024	Recommended Change from Adopted
Intergovernmental Revenues	—	—	—	\$12,924	\$12,924	\$12,924
Subtotal	—	—	—	\$12,924	\$12,924	\$12,924
General Fund Contributions	\$435,952	\$1,028,523	\$1,052,388	\$618,282	\$599,282	\$(429,241)
Total Source of Funds	\$435,952	\$1,028,523	\$1,052,388	\$631,206	\$612,206	\$(416,317)

Unit Description

This unit contains the staff and administrative costs of the Economic Development Administration. Staff within this unit are responsible for the County's economic development, Development Set Aside Agencies funding, and small business loans. Other responsibilities include staffing the Economic Opportunity Committee (EOC).

This unit is formerly known as Housing and Economic Development Administration. The housing functions were reorganized to Housing and Community Development Department in Fiscal Year 2021-22.

Recommended FY 2023-24 Positions

Classification Code	Classification Label	FTE
14C30	MANAGEMENT ANALYST II	1.00
14M12	ECONOMIC DEVELOPMENT MANAGER	1.00
Total		2.00

Laguna Seca Recreational Area

(Budget Unit 8536—Fund 453—Appropriation Unit CA0046)

Use of Funds

Intentionally Left Blank

Source of Funds

Intentionally Left Blank

Use of Funds

Expenditures	Prior Year 2021-2022	Adopted Budget 2022-2023	CY Estimate 2022-2023	Requested Budget 2023-2024	Recommended Budget 2023-2024	Recommended Change from Adopted
Salaries and Employee Benefits	\$335,019	—	—	—	—	—
Services and Supplies	\$18,992,191	—	—	—	—	—
Other Charges	\$1,052,555	—	—	—	—	—
Capital Assets	\$105,469	—	—	—	—	—
Other Financing Uses	\$1,283,905	—	—	—	—	—
Subtotal	\$21,769,139	—	—	—	—	—

Source of Funds

Revenues	Prior Year 2021-2022	Adopted Budget 2022-2023	CY Estimate 2022-2023	Requested Budget 2023-2024	Recommended Budget 2023-2024	Recommended Change from Adopted
Revenue from Use of Money & Property	\$19,047,557	—	—	—	—	—
Miscellaneous Revenues	\$1,228,482	—	—	—	—	—
Other Financing Sources	\$7,850	—	—	—	—	—
Subtotal	\$20,283,889	—	—	—	—	—
Fund Balance	\$1,485,249	—	—	—	—	—
Total Source of Funds	\$21,769,139	—	—	—	—	—

Unit Description

Beginning in FY 2022-23 this unit was transferred to Public Works Facilities and Parks.

Emergency Operations Center

(Budget Unit 8541—Fund 001—Appropriation Unit CAO005)

Use of Funds	Source of Funds
Intentionally Left Blank	Intentionally Left Blank

Use of Funds						
Expenditures	Prior Year 2021-2022	Adopted Budget 2022-2023	CY Estimate 2022-2023	Requested Budget 2023-2024	Recommended Budget 2023-2024	Recommended Change from Adopted
Services and Supplies	\$2,996,757	\$305,000	—	—	—	\$(305,000)
Other Charges	\$138,854	—	—	—	—	—
Capital Assets	\$11,589	—	—	—	—	—
Subtotal	\$3,147,200	\$305,000	—	—	—	\$(305,000)

Source of Funds						
Revenues	Prior Year 2021-2022	Adopted Budget 2022-2023	CY Estimate 2022-2023	Requested Budget 2023-2024	Recommended Budget 2023-2024	Recommended Change from Adopted
Intergovernmental Revenues	\$290,338	—	—	—	—	—
Subtotal	\$290,338	—	—	—	—	—
General Fund Contributions	\$2,856,862	\$305,000	—	—	—	\$(305,000)
Total Source of Funds	\$3,147,200	\$305,000	—	—	—	\$(305,000)

Unit Description

Beginning in FY 2023-24 this unit was transferred to the Department of Emergency Management.

CAO Non-Departmental

Use of Funds

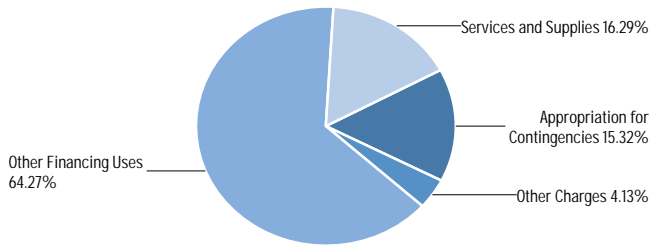

Source of Funds

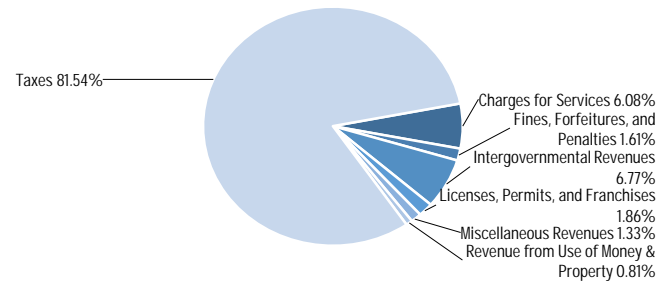

Use of Funds

Expenditures	Prior Year 2021-2022	Adopted Budget 2022-2023	CY Estimate 2022-2023	Requested Budget 2023-2024	Recommended Budget 2023-2024	Recommended Change from Adopted
Services and Supplies	\$4,772,974	\$9,343,922	\$6,583,934	\$8,438,559	\$8,438,559	\$(905,363)
Other Charges	\$1,535,358	\$2,098,834	\$2,098,834	\$2,138,407	\$2,138,407	\$39,573
Capital Assets	\$2,586,533	\$697,354	\$660,321	—	—	\$(697,354)
Other Financing Uses	\$35,272,742	\$73,796,489	\$81,350,180	\$30,853,419	\$33,291,419	\$(40,505,070)
Appropriation for Contingencies	—	\$7,398,322	\$541,260	\$7,933,546	\$7,933,546	\$535,224
Subtotal	\$44,167,607	\$93,334,921	\$91,234,529	\$49,363,931	\$51,801,931	\$(41,532,990)

Source of Funds

Revenues	Prior Year 2021-2022	Adopted Budget 2022-2023	CY Estimate 2022-2023	Requested Budget 2023-2024	Recommended Budget 2023-2024	Recommended Change from Adopted
Taxes	\$262,403,221	\$250,489,150	\$265,563,764	\$275,148,829	\$275,148,829	\$24,659,679
Licenses, Permits, and Franchises	\$7,766,352	\$5,715,477	\$6,260,703	\$6,260,703	\$6,260,703	\$545,226
Fines, Forfeitures, and Penalties	\$6,838,103	\$6,105,650	\$4,827,341	\$5,444,712	\$5,444,712	\$(660,938)
Revenue from Use of Money & Property	\$1,026,184	\$2,544,509	\$4,177,478	\$2,735,765	\$2,735,765	\$191,256
Intergovernmental Revenues	\$26,236,249	\$30,735,971	\$30,826,073	\$9,250,122	\$22,859,304	\$(7,876,667)
Charges for Services	\$9,610,707	\$5,257,578	\$5,245,320	\$20,509,673	\$20,509,673	\$15,252,095
Miscellaneous Revenues	\$5,072,379	\$4,322,368	\$4,586,052	\$4,482,928	\$4,482,928	\$160,560
Other Financing Sources	\$12,165,882	\$15,402,538	\$30,805,076	—	—	\$(15,402,538)
Subtotal	\$331,119,077	\$320,573,241	\$352,291,807	\$323,832,732	\$337,441,914	\$16,868,673
Other Fund - Fund Balance	\$(27,758,799)	\$(11,153,180)	\$(23,264,527)	\$(18,507,267)	\$(17,557,267)	\$(6,404,087)
General Fund - Assigned Fund Balance	—	—	—	\$2,288,000	\$2,288,000	\$2,288,000
General Fund Contributions	\$(259,192,671)	\$(216,085,140)	\$(237,792,751)	\$(258,249,534)	\$(270,370,716)	\$(54,285,576)
Total Source of Funds	\$44,167,607	\$93,334,921	\$91,234,529	\$49,363,931	\$51,801,931	\$(41,532,990)

Division Description

The CAO's non-departmental operations consist of annual debt service, contributions to fire agencies, contributions to other funds within the County and external agencies, appropriation for contingencies, economic development set-asides, memberships in governmental organizations (e.g., California State Association of Counties), Resource Planning Internal Service Fund, support required for trial courts, and appropriation of realignment monies for health and social services programs.

Summary of Recommendation

The FY 2023-24 Recommended Budget for the CAO's non-departmental operations is \$51,801,931, a decrease of \$41,532,990 from the prior year adopted budget, including \$40,426,483 decrease in transfers to outside funds and \$1,645,959 decrease due to reorganization of the Department of Emergency Management's Homeland Security Grant Fund. Partially offsetting these reductions include \$3,129,198 increase for Enterprise Resource Planning and \$535,224 increase in contingencies to the level required by policy.

Appropriation Expenditure Detail

	Prior Year 2021-2022	Adopted Budget 2022-2023	CY Estimate 2022-2023	Requested Budget 2023-2024	Recommended Budget 2023-2024	Recommended Change from Adopted	Fund Code	Budget Unit Code
Contributions - Proposition 172 (CAO007)	3,295,753	3,529,729	3,529,729	4,041,183	4,041,183	511,454	001	8028
Contributions-Other Agencies (CAO007)	4,831,337	3,238,847	1,438,847	836,945	836,945	(2,401,902)	001	8029
Trial Courts (CAO008)	7,971,665	8,937,113	7,963,192	8,288,269	8,288,269	(648,844)	001	8031
Contingencies (CAO020)	0	7,398,322	541,260	7,933,546	7,933,546	535,224	001	8034
County Memberships (CAO013)	81,682	81,682	81,682	85,664	85,664	3,982	001	8035
Medical Care Services (CAO016)	3,900,648	3,900,648	3,900,648	3,900,648	3,900,648	0	001	8037
Other Financing Uses (CAO017)	29,617,287	49,581,916	54,656,532	19,144,381	20,632,381	(28,949,535)	001	8038
Other General Expenditures (CAO014)	(106,253)	288,674	288,674	200,000	200,000	(88,674)	001	8039
Homeland Security Grant (CAO023)	529,162	1,645,959	1,660,959	0	0	(1,645,959)	024	8412
Laguna Seca Track (CAO029)	0	0	0	0	0	0	001	8441
Auxiliary Services (CAO027)	24,131	26,144	12,000	51,125	51,125	24,981	001	8472
Vehicle Replacement Planning (CAO032)	2,330,080	0	0	0	0	0	478	8483
Enterprise Resource Planning (CAO034)	(599,082)	494,776	899,949	3,623,974	3,623,974	3,129,198	478	8506
Development Set-Aside (CAO036)	3,454,664	6,231,129	3,752,000	3,722,000	3,722,000	(2,509,129)	001	8512
Inclusionary Housing (CAO039)	0	0	0	0	0	0	009	8515
Revolving Loan Program (CAO040)	511,873	1,150,500	1,150,500	1,150,500	1,150,500	0	011	8516
Community Development Reuse (CAO041)	0	0	0	0	0	0	013	8517
Community Development Grant (CAO042)	(0)	0	0	0	0	0	013	8518
Boronda HS-A (CAO043)	0	0	0	0	0	0	176	8519
Castro/Paj HS-A (CAO044)	0	0	0	0	0	0	175	8520
Building Improvement and Replacement (CAO047)	(10,447,078)	7,089,250	11,368,325	(3,412,698)	(2,462,698)	(9,551,948)	478	8539
Equipment Replacement (CAO048)	(1,274,121)	(259,768)	(259,768)	(501,606)	(501,606)	(241,838)	478	8568
Pension Unfunded Liability (CAO049)	45,859	0	250,000	300,000	300,000	300,000	030	8570
Subtotal	\$44,167,607	\$93,334,921	\$91,234,529	\$49,363,931	\$51,801,931	\$(41,532,990)		

Contributions - Proposition 172

(Budget Unit 8028—Fund 001—Appropriation Unit CAO007)

Use of Funds

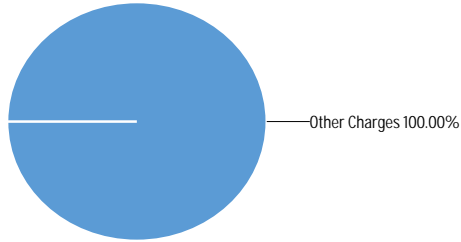

Source of Funds

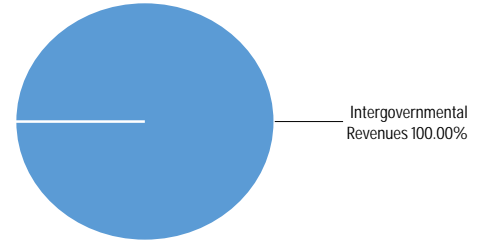

Use of Funds

Expenditures	Prior Year 2021-2022	Adopted Budget 2022-2023	CY Estimate 2022-2023	Requested Budget 2023-2024	Recommended Budget 2023-2024	Recommended Change from Adopted
Other Charges	\$3,295,753	\$3,529,729	\$3,529,729	\$4,041,183	\$4,041,183	\$511,454
Subtotal	\$3,295,753	\$3,529,729	\$3,529,729	\$4,041,183	\$4,041,183	\$511,454

Source of Funds

Revenues	Prior Year 2021-2022	Adopted Budget 2022-2023	CY Estimate 2022-2023	Requested Budget 2023-2024	Recommended Budget 2023-2024	Recommended Change from Adopted
Intergovernmental Revenues	\$4,041,183	\$3,529,729	\$3,529,729	\$4,041,183	\$4,041,183	\$511,454
Subtotal	\$4,041,183	\$3,529,729	\$3,529,729	\$4,041,183	\$4,041,183	\$511,454
General Fund Contributions	\$(745,430)	—	—	—	—	—
Total Source of Funds	\$3,295,753	\$3,529,729	\$3,529,729	\$4,041,183	\$4,041,183	\$511,454

Unit Description

This unit accounts for the County's Public Safety Sales Tax (Proposition 172) revenues that the County contributes to fire protection service providers in the unincorporated areas. In FY 2011-12, the CAO and the Association of Fire Fighters and Volunteer Fire

Companies agreed to a disbursement model for Proposition 172 revenues. Beginning FY 2011-12, the County began sharing with the Association 9.13% of Proposition 172 revenues for the most recently audited fiscal year.

Contributions-Other Agencies

(Budget Unit 8029—Fund 001—Appropriation Unit CA0007)

Use of Funds

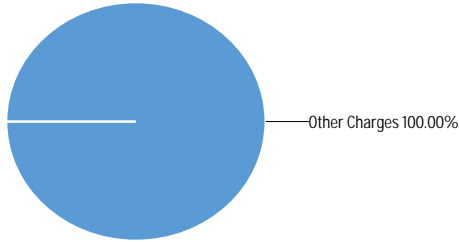

Source of Funds

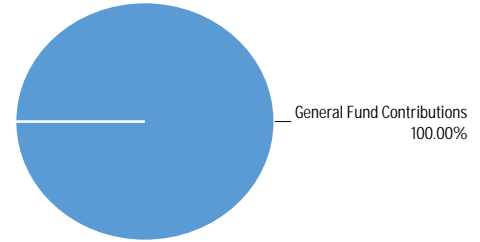

Use of Funds

Expenditures	Prior Year 2021-2022	Adopted Budget 2022-2023	CY Estimate 2022-2023	Requested Budget 2023-2024	Recommended Budget 2023-2024	Recommended Change from Adopted
Services and Supplies	\$109,332	—	—	—	—	—
Other Charges	\$4,722,005	\$1,438,847	\$1,438,847	\$836,945	\$836,945	\$(601,902)
Other Financing Uses	—	\$1,800,000	—	—	—	\$(1,800,000)
Subtotal	\$4,831,337	\$3,238,847	\$1,438,847	\$836,945	\$836,945	\$(2,401,902)

Source of Funds

Revenues	Prior Year 2021-2022	Adopted Budget 2022-2023	CY Estimate 2022-2023	Requested Budget 2023-2024	Recommended Budget 2023-2024	Recommended Change from Adopted
Other Financing Sources	\$2,000,000	—	—	—	—	—
Subtotal	\$2,000,000	—	—	—	—	—
General Fund Contributions	\$2,831,337	\$3,238,847	\$1,438,847	\$836,945	\$836,945	\$(2,401,902)
Total Source of Funds	\$4,831,337	\$3,238,847	\$1,438,847	\$836,945	\$836,945	\$(2,401,902)

Unit Description

This unit tracks contributions made to other agencies, including: Association of Monterey Bay Area Governments; CA Cannabis Authority JPA; Court Appointed Special Advocates; Local Agency

Formation Commission; Monterey Bay Unified Air Pollution Control District; Pajaro River Watershed Flood Prevention Authority; Pajaro/Sunny Mesa Community Services District; Prunedale Senior Center.

Trial Courts

(Budget Unit 8031—Fund 001—Appropriation Unit CAO008)

Use of Funds

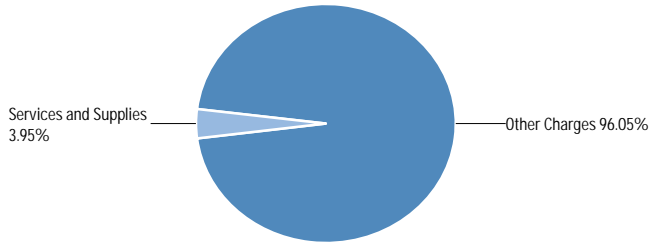

Source of Funds

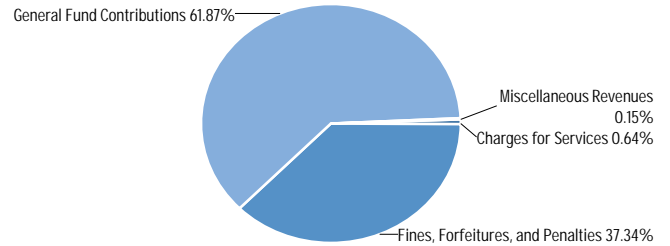

Use of Funds

Expenditures	Prior Year 2021-2022	Adopted Budget 2022-2023	CY Estimate 2022-2023	Requested Budget 2023-2024	Recommended Budget 2023-2024	Recommended Change from Adopted
Services and Supplies	\$10,707	\$976,155	\$2,234	\$327,311	\$327,311	\$(648,844)
Other Charges	\$7,960,958	\$7,960,958	\$7,960,958	\$7,960,958	\$7,960,958	—
Subtotal	\$7,971,665	\$8,937,113	\$7,963,192	\$8,288,269	\$8,288,269	\$(648,844)

Source of Funds

Revenues	Prior Year 2021-2022	Adopted Budget 2022-2023	CY Estimate 2022-2023	Requested Budget 2023-2024	Recommended Budget 2023-2024	Recommended Change from Adopted
Fines, Forfeitures, and Penalties	\$2,863,813	\$3,753,132	\$2,474,823	\$3,092,194	\$3,092,194	\$(660,938)
Revenue from Use of Money & Property	\$649	\$678	\$4,655	\$6,472	\$6,472	\$5,794
Charges for Services	\$39,848	\$52,910	\$44,818	\$52,968	\$52,968	\$58
Miscellaneous Revenues	\$2,550	\$6,350	\$13,493	\$12,592	\$12,592	\$6,242
Subtotal	\$2,906,859	\$3,813,070	\$2,537,789	\$3,164,226	\$3,164,226	\$(648,844)
General Fund Contributions	\$5,064,806	\$5,124,043	\$5,425,403	\$5,124,043	\$5,124,043	—
Total Source of Funds	\$7,971,665	\$8,937,113	\$7,963,192	\$8,288,269	\$8,288,269	\$(648,844)

Unit Description

The Trial Courts budget accounts for the County’s obligations to the State on behalf of the Courts as outlined in Senate Bill (SB) 1732 and subsequently amended by Assembly Bill (AB) 233, the Trial Courts Funding Act of 2002 (the Act). AB 233 authorized the transfer of responsibility for Trial Courts funding from counties to the State and established an expenditure and revenue Maintenance of Effort (MOE) obligation for each county. The County MOE is based on the amount of County General Fund dollars expended for Trial Courts operations and the amount of certain designated fines and forfeiture revenues distributed to the State in the base year (FY 1994-95). Additionally, AB 233 required the County to share with the State any increase in revenues on 50-50 basis that occurred beyond the revenue base set forth in the Act. The Trial Courts budget provides for local Trial Courts activities that affect County expenditures and revenues, including: Trial Courts MOE payments; County Facility Payments (CFPs); 50-50 revenue share with the State; revenue collection related costs for specified fines and fees; judicial benefits and other court

collection costs, as agreed by the County, the Superior Court of Monterey County, and the Administration Office of the Courts (AOC).

Revenues reflect all fines, forfeitures, and fees currently collected on behalf of the County by both the Superior Court of Monterey County and the Revenue Division of the Treasurer -Tax Collector’s Office. The Revenue Division is responsible for the Criminal Court Collections Program (CCCP) for the County. Pursuant to the Act, the County transferred the Marina Courthouse title to the AOC, effective December 31, 2008. On March 30, 2009, the County executed a transfer of responsibility for the Monterey, King City, and Juvenile Court facilities. Responsibility for the Salinas North Wing Court Facility transferred to the AOC on October 12, 2010. However, title to the North Wing and Monterey facilities will not transfer to the AOC until the bonded indebtedness, to which the buildings are subject, is paid. CFPs associated with these transfers are budgeted in this unit.

Contingencies

(Budget Unit 8034—Fund 001—Appropriation Unit CAO020)

Use of Funds

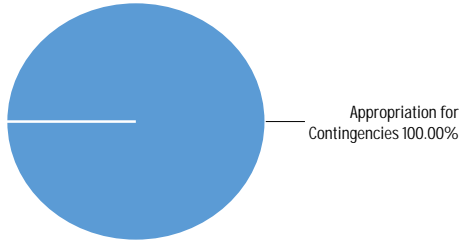

Source of Funds

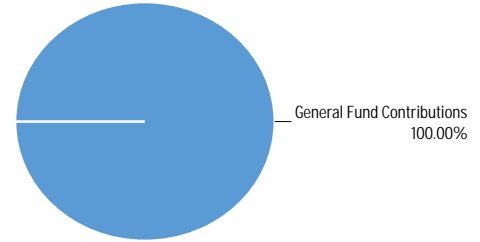

Use of Funds

Expenditures	Prior Year 2021-2022	Adopted Budget 2022-2023	CY Estimate 2022-2023	Requested Budget 2023-2024	Recommended Budget 2023-2024	Recommended Change from Adopted
Appropriation for Contingencies	—	\$7,398,322	\$541,260	\$7,933,546	\$7,933,546	\$535,224
Subtotal	—	\$7,398,322	\$541,260	\$7,933,546	\$7,933,546	\$535,224

Source of Funds

Revenues	Prior Year 2021-2022	Adopted Budget 2022-2023	CY Estimate 2022-2023	Requested Budget 2023-2024	Recommended Budget 2023-2024	Recommended Change from Adopted
General Fund Contributions	—	\$7,398,322	\$541,260	\$7,933,546	\$7,933,546	\$535,224
Total Source of Funds	—	\$7,398,322	\$541,260	\$7,933,546	\$7,933,546	\$535,224

Unit Description

The County maintains a portion of the General Fund as an appropriation for operational contingencies to provide the County with sufficient working capital and a margin of safety for such impacts as natural disasters, economic shocks resulting in significant revenue shortfalls and/or program changes. Monterey County's

financial policies specify an annual appropriation for contingencies equivalent to 1% of total General Fund estimated revenues. In the event of an emergency and/or unexpected revenue decline, the appropriation for contingencies may be used at the discretion of and by action of the BOS. These funds are utilized only after all other budget sources have been examined.

County Memberships

(Budget Unit 8035—Fund 001—Appropriation Unit CAO013)

Use of Funds

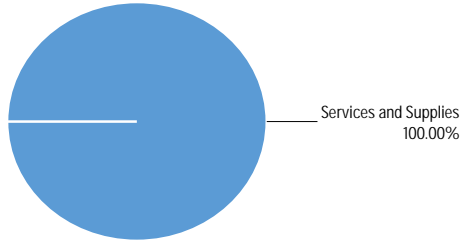

Source of Funds

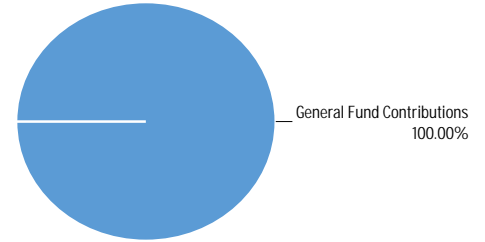

Use of Funds

Expenditures	Prior Year 2021-2022	Adopted Budget 2022-2023	CY Estimate 2022-2023	Requested Budget 2023-2024	Recommended Budget 2023-2024	Recommended Change from Adopted
Services and Supplies	\$81,682	\$81,682	\$81,682	\$85,664	\$85,664	\$3,982
Subtotal	\$81,682	\$81,682	\$81,682	\$85,664	\$85,664	\$3,982

Source of Funds

Revenues	Prior Year 2021-2022	Adopted Budget 2022-2023	CY Estimate 2022-2023	Requested Budget 2023-2024	Recommended Budget 2023-2024	Recommended Change from Adopted
General Fund Contributions	\$81,682	\$81,682	\$81,682	\$85,664	\$85,664	\$3,982
Total Source of Funds	\$81,682	\$81,682	\$81,682	\$85,664	\$85,664	\$3,982

Unit Description

This unit provides payment for annual memberships to California Coastal Trail Association (CCTA), California State Association of Counties (CSAC), National Association of Counties (NACO), Rural

County Representatives of California (RCRC). These organizations provide information on issues of interest to the County and provide an opportunity for the County to network with other boards and administrative staff.

Medical Care Services

(Budget Unit 8037—Fund 001—Appropriation Unit CA0016)

Use of Funds

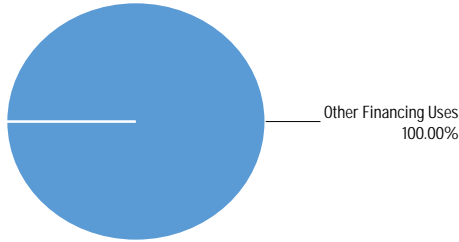

Source of Funds

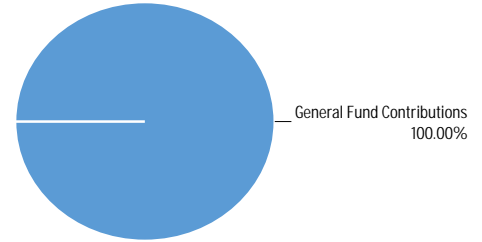

Use of Funds

Expenditures	Prior Year 2021-2022	Adopted Budget 2022-2023	CY Estimate 2022-2023	Requested Budget 2023-2024	Recommended Budget 2023-2024	Recommended Change from Adopted
Other Financing Uses	\$3,900,648	\$3,900,648	\$3,900,648	\$3,900,648	\$3,900,648	—
Subtotal	\$3,900,648	\$3,900,648	\$3,900,648	\$3,900,648	\$3,900,648	—

Source of Funds

Revenues	Prior Year 2021-2022	Adopted Budget 2022-2023	CY Estimate 2022-2023	Requested Budget 2023-2024	Recommended Budget 2023-2024	Recommended Change from Adopted
General Fund Contributions	\$3,900,648	\$3,900,648	\$3,900,648	\$3,900,648	\$3,900,648	—
Total Source of Funds	\$3,900,648	\$3,900,648	\$3,900,648	\$3,900,648	\$3,900,648	—

Unit Description

Pursuant to Welfare and Institutions Code Section 17000, counties are required to provide medical care to indigent residents lawfully residing in the County when such persons are not supported by some other means. In prior fiscal years, the Medical Care Services unit provided a General Fund payment to Natividad Medical Center and the Health Department to cover costs associated with indigent medical care. Beginning in FY 2012-13, a change in accounting for realignment dollars resulted in this unit being used to appropriate Vehicle License Fee (VLF) for the Health Department and the

Department of Social Services; the County’s portion of the Sales Tax Revenue match for health services; and the Sales Tax Revenue match for Mental Health Services. However, changes in statutes eliminated the requirement for counties to deposit VLF into the General Fund; therefore, they are deposited directly into their respective trust fund accounts.

The Recommended Budget allocates the Public Health Realignment funds as follows: \$532,678 Behavioral Health Mental Health Services and \$3.4 million Health Department’s Maintenance of Effort.

Other Financing Uses

(Budget Unit 8038—Fund 001—Appropriation Unit CA0017)

Use of Funds

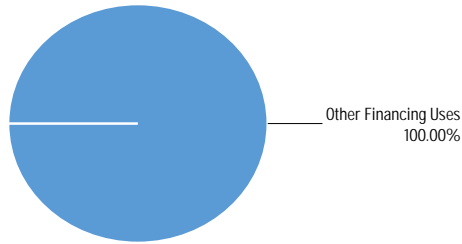

Source of Funds

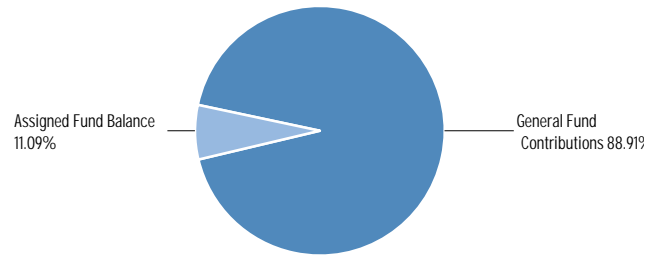

Use of Funds

Expenditures	Prior Year 2021-2022	Adopted Budget 2022-2023	CY Estimate 2022-2023	Requested Budget 2023-2024	Recommended Budget 2023-2024	Recommended Change from Adopted
Other Financing Uses	\$29,617,287	\$49,581,916	\$54,656,532	\$19,144,381	\$20,632,381	\$(28,949,535)
Subtotal	\$29,617,287	\$49,581,916	\$54,656,532	\$19,144,381	\$20,632,381	\$(28,949,535)

Source of Funds

Revenues	Prior Year 2021-2022	Adopted Budget 2022-2023	CY Estimate 2022-2023	Requested Budget 2023-2024	Recommended Budget 2023-2024	Recommended Change from Adopted
General Fund Contributions	\$29,617,287	\$49,581,916	\$54,656,532	\$16,856,381	\$18,344,381	\$(31,237,535)
General Fund - Assigned Fund Balance	—	—	—	\$2,288,000	\$2,288,000	\$2,288,000
Total Source of Funds	\$29,617,287	\$49,581,916	\$54,656,532	\$19,144,381	\$20,632,381	\$(28,949,535)

Unit Description

This unit makes payments and contributions from the General Fund to other County Funds for debt service, capital projects, contributions and general subsidies. Funding may also be included for issues requiring additional review, analysis, County services, and issues that are exempt from the Brown Act, such as real estate/property

negotiations. The FY 2023-24 Recommended Budget for Other Financing Uses totals \$20,632,381, a decrease of \$28,949,535 from the prior year attributed mainly to the pension liability trust fund transfer. The FY 2023-24 Recommended Budget includes annual transfers to the Road Fund and debt service.

Other General Expenditures

(Budget Unit 8039—Fund 001—Appropriation Unit CA0014)

Use of Funds

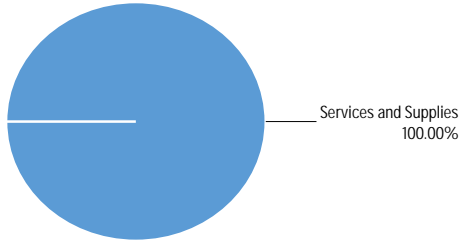

Source of Funds

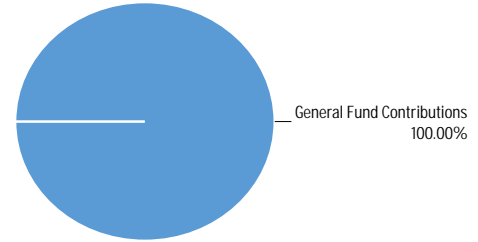

Use of Funds

Expenditures	Prior Year 2021-2022	Adopted Budget 2022-2023	CY Estimate 2022-2023	Requested Budget 2023-2024	Recommended Budget 2023-2024	Recommended Change from Adopted
Services and Supplies	\$154,540	\$441,940	\$441,940	\$200,000	\$200,000	\$(241,940)
Other Charges	\$(260,793)	\$(153,266)	\$(153,266)	—	—	\$153,266
Subtotal	\$(106,253)	\$288,674	\$288,674	\$200,000	\$200,000	\$(88,674)

Source of Funds

Revenues	Prior Year 2021-2022	Adopted Budget 2022-2023	CY Estimate 2022-2023	Requested Budget 2023-2024	Recommended Budget 2023-2024	Recommended Change from Adopted
General Fund Contributions	\$(106,253)	\$288,674	\$288,674	\$200,000	\$200,000	\$(88,674)
Total Source of Funds	\$(106,253)	\$288,674	\$288,674	\$200,000	\$200,000	\$(88,674)

Unit Description

This unit provides for general purpose expenses not allocated to an existing department or program, including external audit services and the Budget Committee.

External audit services include financial statements, Single Audits, and non-CAFR entities.

The Budget Committee budget allows for the engagement of outside firms to conduct audits to ensure independence and oversight of the County's financial reporting process. The committee will assist the Board to fulfill responsibilities regarding financial reporting, internal control systems, and the audit process.

Non-Program Revenue

(Budget Unit 8041—Fund 001—Appropriation Unit CAO019)

Source of Funds

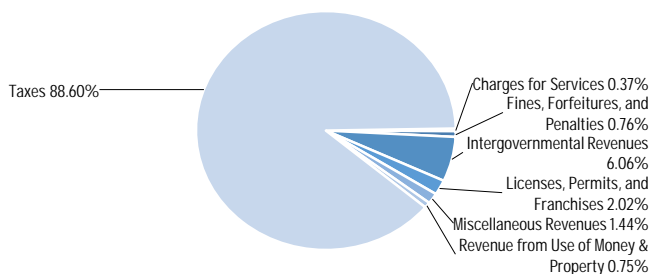

Source of Funds

Revenues	Prior Year 2021-2022	Adopted Budget 2022-2023	CY Estimate 2022-2023	Requested Budget 2023-2024	Recommended Budget 2023-2024	Recommended Change from Adopted
Taxes	\$262,403,221	\$250,489,150	\$265,563,764	\$275,148,829	\$275,148,829	\$24,659,679
Licenses, Permits, and Franchises	\$7,766,352	\$5,715,477	\$6,260,703	\$6,260,703	\$6,260,703	\$545,226
Fines, Forfeitures, and Penalties	\$3,974,291	\$2,352,518	\$2,352,518	\$2,352,518	\$2,352,518	—
Revenue from Use of Money & Property	\$1,980,873	\$2,336,605	\$2,336,605	\$2,336,605	\$2,336,605	—
Intergovernmental Revenues	\$20,539,417	\$25,564,101	\$25,739,203	\$5,208,939	\$18,818,121	\$(6,745,980)
Charges for Services	\$1,554,857	\$1,154,668	\$1,154,668	\$1,154,668	\$1,154,668	—
Miscellaneous Revenues	\$5,067,575	\$4,316,018	\$4,470,336	\$4,470,336	\$4,470,336	\$154,318
Subtotal	\$303,286,585	\$291,928,537	\$307,877,797	\$296,932,598	\$310,541,780	\$18,613,243
General Fund Contributions	\$(303,286,585)	\$(291,928,537)	\$(307,877,797)	\$(296,932,598)	\$(310,541,780)	\$(18,613,243)
Total Source of Funds	—	—	—	—	—	—

Unit Description

This unit includes all non-program revenues that are not directly associated with operating departments. Non-program revenues are discretionary funds. Primary sources of non-program revenues

include property taxes, sales taxes, Transient Occupancy Tax, interest earnings, property transfer tax, utility franchises, tobacco settlement monies, cannabis tax revenue, open space subventions, discretionary State and federal aid, and property tax administrative cost recoveries.

Homeland Security Grant

(Budget Unit 8412—Fund 024—Appropriation Unit CA0023)

Use of Funds	Source of Funds
Intentionally Left Blank	Intentionally Left Blank

Use of Funds

Expenditures	Prior Year 2021-2022	Adopted Budget 2022-2023	CY Estimate 2022-2023	Requested Budget 2023-2024	Recommended Budget 2023-2024	Recommended Change from Adopted
Services and Supplies	\$258,596	\$942,020	\$994,053	—	—	\$(942,020)
Other Charges	\$10,167	\$6,585	\$6,585	—	—	\$(6,585)
Capital Assets	\$260,399	\$697,354	\$660,321	—	—	\$(697,354)
Subtotal	\$529,162	\$1,645,959	\$1,660,959	—	—	\$(1,645,959)

Source of Funds

Revenues	Prior Year 2021-2022	Adopted Budget 2022-2023	CY Estimate 2022-2023	Requested Budget 2023-2024	Recommended Budget 2023-2024	Recommended Change from Adopted
Revenue from Use of Money & Property	\$3,259	\$3,818	\$3,818	—	—	\$(3,818)
Intergovernmental Revenues	\$20,036	\$1,642,141	\$1,557,141	—	—	\$(1,642,141)
Miscellaneous Revenues	\$2,531	—	\$100,000	—	—	—
Subtotal	\$25,827	\$1,645,959	\$1,660,959	—	—	\$(1,645,959)
Fund Balance	\$503,335	—	—	—	—	—
Total Source of Funds	\$529,162	\$1,645,959	\$1,660,959	—	—	\$(1,645,959)

Unit Description

Beginning in FY 2023-24 this unit was transferred to the Department of Emergency Management.

Auxiliary Services

(Budget Unit 8472—Fund 001—Appropriation Unit CAO027)

Use of Funds

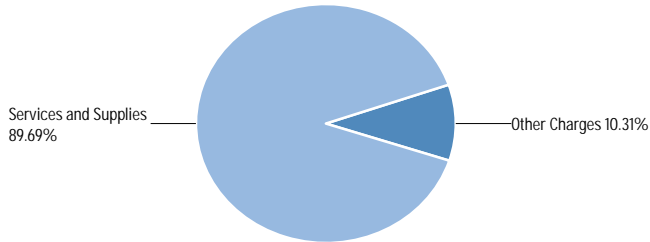

Source of Funds

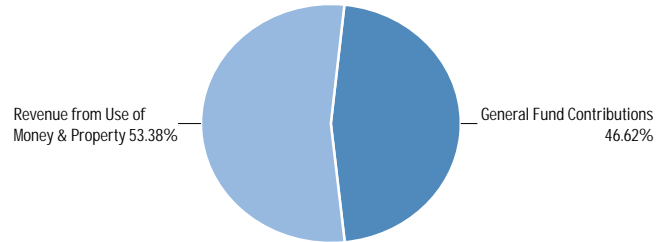

Use of Funds

Expenditures	Prior Year 2021-2022	Adopted Budget 2022-2023	CY Estimate 2022-2023	Requested Budget 2023-2024	Recommended Budget 2023-2024	Recommended Change from Adopted
Services and Supplies	\$21,401	\$26,169	\$12,025	\$45,856	\$45,856	\$19,687
Other Charges	\$2,730	\$(25)	\$(25)	\$5,269	\$5,269	\$5,294
Subtotal	\$24,131	\$26,144	\$12,000	\$51,125	\$51,125	\$24,981

Source of Funds

Revenues	Prior Year 2021-2022	Adopted Budget 2022-2023	CY Estimate 2022-2023	Requested Budget 2023-2024	Recommended Budget 2023-2024	Recommended Change from Adopted
Revenue from Use of Money & Property	\$28,959	\$28,008	\$12,000	\$27,288	\$27,288	\$(720)
Subtotal	\$28,959	\$28,008	\$12,000	\$27,288	\$27,288	\$(720)
General Fund Contributions	\$(4,828)	\$(1,864)	—	\$23,837	\$23,837	\$25,701
Total Source of Funds	\$24,131	\$26,144	\$12,000	\$51,125	\$51,125	\$24,981

Unit Description

The Auxiliary Service unit oversees services for the County cafeterias and the daycare located at the Schilling Place complex.

Vehicle Replacement Planning

(Budget Unit 8483—Fund 478—Appropriation Unit CA0032)

Use of Funds

Source of Funds

Intentionally Left Blank

Intentionally Left Blank

Use of Funds

Expenditures	Prior Year 2021-2022	Adopted Budget 2022-2023	CY Estimate 2022-2023	Requested Budget 2023-2024	Recommended Budget 2023-2024	Recommended Change from Adopted
Other Charges	\$3,945	—	—	—	—	—
Capital Assets	\$2,326,135	—	—	—	—	—
Subtotal	\$2,330,080	—	—	—	—	—

Source of Funds

Revenues	Prior Year 2021-2022	Adopted Budget 2022-2023	CY Estimate 2022-2023	Requested Budget 2023-2024	Recommended Budget 2023-2024	Recommended Change from Adopted
Charges for Services	\$4,016,002	—	—	—	—	—
Other Financing Sources	\$179,062	—	—	—	—	—
Subtotal	\$4,195,064	—	—	—	—	—
Fund Balance	\$(1,864,984)	—	—	—	—	—
Total Source of Funds	\$2,330,080	—	—	—	—	—

Unit Description

Beginning in FY 2022-23 this unit was transferred to Public Works Facilities and Parks. Under the Vehicle Asset Management Program (VAMP), participating departments are charged a monthly future

replacement fee during the useful life of the vehicle. These funds are then used to replace the vehicle after it has been fully depreciated, typically six to eight years.

Enterprise Resource Planning

(Budget Unit 8506—Fund 478—Appropriation Unit CA0034)

Use of Funds

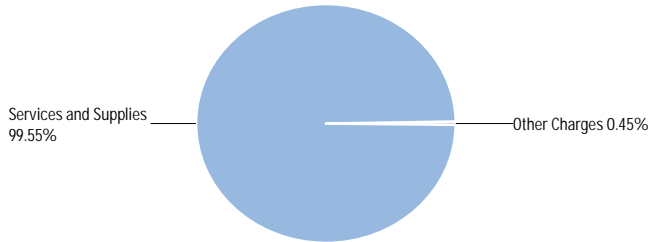

Source of Funds

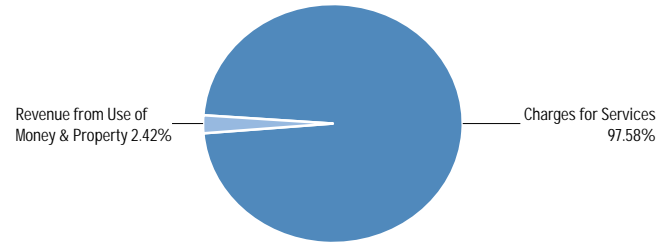

Use of Funds

Expenditures	Prior Year 2021-2022	Adopted Budget 2022-2023	CY Estimate 2022-2023	Requested Budget 2023-2024	Recommended Budget 2023-2024	Recommended Change from Adopted
Services and Supplies	\$124,319	\$494,827	\$900,000	\$3,607,728	\$3,607,728	\$3,112,901
Other Charges	\$(723,401)	\$(51)	\$(51)	\$16,246	\$16,246	\$16,297
Subtotal	\$(599,082)	\$494,776	\$899,949	\$3,623,974	\$3,623,974	\$3,129,198

Source of Funds

Revenues	Prior Year 2021-2022	Adopted Budget 2022-2023	CY Estimate 2022-2023	Requested Budget 2023-2024	Recommended Budget 2023-2024	Recommended Change from Adopted
Revenue from Use of Money & Property	\$240,429	\$45,000	\$110,000	\$100,000	\$100,000	\$55,000
Charges for Services	\$4,000,000	\$4,000,000	\$3,995,834	\$4,024,334	\$4,024,334	\$24,334
Subtotal	\$4,240,429	\$4,045,000	\$4,105,834	\$4,124,334	\$4,124,334	\$79,334
Fund Balance	\$(4,839,511)	\$(3,550,224)	\$(3,205,885)	\$(500,360)	\$(500,360)	\$3,049,864
Total Source of Funds	\$(599,082)	\$494,776	\$899,949	\$3,623,974	\$3,623,974	\$3,129,198

Unit Description

The Enterprise Resource Planning (ERP) unit is a component of the Resource Planning Internal Service Fund (ISF). The ERP unit is composed of an ERP replacement/upgrade reserve to be used for the cost of the County's upcoming ERP replacement. Departments are

billed annually for the reserve, thus minimizing fiscal impacts on departmental operations. A given department's allocation may change from year to year due to changes in the number of adopted full-time equivalents.

Development Set-Aside

(Budget Unit 8512—Fund 001—Appropriation Unit CA0036)

Use of Funds

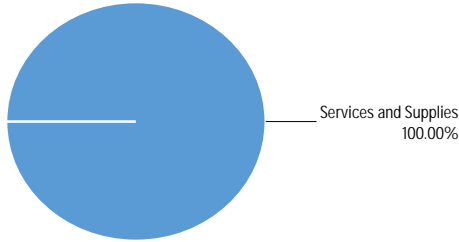

Source of Funds

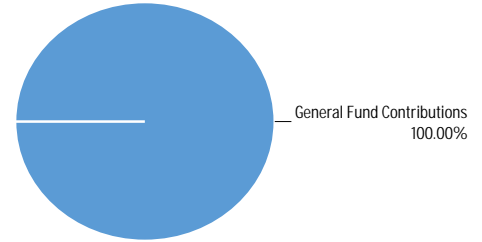

Use of Funds

Expenditures	Prior Year 2021-2022	Adopted Budget 2022-2023	CY Estimate 2022-2023	Requested Budget 2023-2024	Recommended Budget 2023-2024	Recommended Change from Adopted
Services and Supplies	\$3,454,664	\$6,231,129	\$3,752,000	\$3,722,000	\$3,722,000	\$(2,509,129)
Subtotal	\$3,454,664	\$6,231,129	\$3,752,000	\$3,722,000	\$3,722,000	\$(2,509,129)

Source of Funds

Revenues	Prior Year 2021-2022	Adopted Budget 2022-2023	CY Estimate 2022-2023	Requested Budget 2023-2024	Recommended Budget 2023-2024	Recommended Change from Adopted
General Fund Contributions	\$3,454,664	\$6,231,129	\$3,752,000	\$3,722,000	\$3,722,000	\$(2,509,129)
Total Source of Funds	\$3,454,664	\$6,231,129	\$3,752,000	\$3,722,000	\$3,722,000	\$(2,509,129)

Unit Description

The Development Set-Aside (DSA) unit provides funding for economic development, tourism marketing filmmaking cultural arts programs, and small business outreach that strengthen the workforce in Monterey County and broaden the County’s economic base to increase revenue and promote the creation and retention of jobs. The Board of Supervisors designated the Arts Council of Monterey County (ACMC), the Monterey County Convention and Visitors Bureau (MCCVB), the Monterey County Film Commission (MCFC), and the Monterey County Business Council (MCBC) to implement specific aspects of the DSA program. Funding is provided on a formula basis for MCCVB, ACMC, MCFC, and a flat rate for

MCBC. More details can be found in the Contributions/Obligations, Liabilities, and Other section.

The Arts Council provides cultural arts programs throughout the County. The MCCVB implements a destination-marketing program to attract new and repeat visitors to Monterey County. The MCFC markets the County as an ideal location for filming commercials, made-for-TV movies, feature films, and still catalogs. The Monterey County Business Council facilitates implementation of the Competitive Clusters Program, and accelerating regional development of small business and the creation and retention of jobs through the joint efforts of the MCBC and Monterey Bay Procurement Technical Assistance Center (PTAC).

Inclusionary Housing

(Budget Unit 8515—Fund 009—Appropriation Unit CAO039)

Source of Funds

Intentionally Left Blank

Source of Funds

Revenues	Prior Year 2021-2022	Adopted Budget 2022-2023	CY Estimate 2022-2023	Requested Budget 2023-2024	Recommended Budget 2023-2024	Recommended Change from Adopted
Revenue from Use of Money & Property	\$1,374	—	—	—	—	—
Subtotal	\$1,374	—	—	—	—	—
Fund Balance	\$(1,374)	—	—	—	—	—
Total Source of Funds	—	—	—	—	—	—

Unit Description

This unit was moved to Housing and Community Development Department in Fiscal Year 2021-22.

The Inclusionary Housing Program was established through an Ordinance adopted by the Board of Supervisors in FY 1979-80. The Ordinance has been amended several times, most recently in 2011. The purpose of the Inclusionary Housing Fund is to facilitate development of housing for low and moderate income residents of Monterey County. The Fund is capitalized through payment of in-lieu fees by developers of subdivision projects and repayment of project loans made from inclusionary funds.

Revenue from the funds are distributed to eligible for-profit and non-profit developers to assist with the cost of providing affordable housing to households earning less than 120% of the County median

income. The County Housing Advisory Committee reviews affordable housing proposals. The Fund also supports the cost of administering and monitoring the existing loan portfolio, monitoring inclusionary units, and administering and monitoring all other compliance matters relating to the Inclusionary Housing Ordinance, as well as the land entitlement process. All revenue must be spent in accordance with the requirements of the adopted Inclusionary Housing Ordinance.

The Inclusionary Housing Program provides an opportunity for very low, low and moderate income households to purchase or rent affordable inclusionary units throughout the unincorporated areas of the County of Monterey. Currently, there are approximately 241 owner-occupied inclusionary units, and 423 tenant-occupied units in the Inclusionary Housing Program.

Revolving Loan Program

(Budget Unit 8516—Fund 011—Appropriation Unit CA0040)

Use of Funds

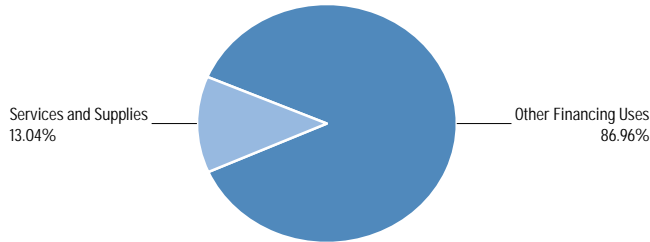

Source of Funds

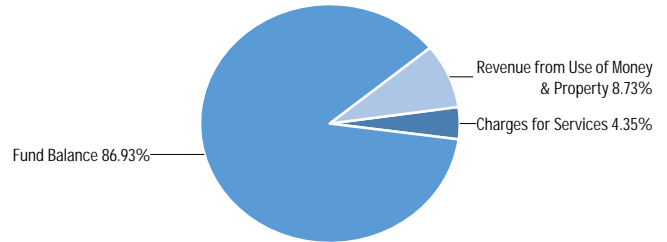

Use of Funds

Expenditures	Prior Year 2021-2022	Adopted Budget 2022-2023	CY Estimate 2022-2023	Requested Budget 2023-2024	Recommended Budget 2023-2024	Recommended Change from Adopted
Services and Supplies	\$511,873	\$150,000	\$150,000	\$150,000	\$150,000	—
Other Charges	—	\$500	\$500	\$500	\$500	—
Other Financing Uses	—	\$1,000,000	\$1,000,000	\$1,000,000	\$1,000,000	—
Subtotal	\$511,873	\$1,150,500	\$1,150,500	\$1,150,500	\$1,150,500	—

Source of Funds

Revenues	Prior Year 2021-2022	Adopted Budget 2022-2023	CY Estimate 2022-2023	Requested Budget 2023-2024	Recommended Budget 2023-2024	Recommended Change from Adopted
Revenue from Use of Money & Property	\$75,294	\$100,400	\$100,400	\$100,400	\$100,400	—
Intergovernmental Revenues	\$1,635,614	—	—	—	—	—
Charges for Services	—	\$50,000	\$50,000	\$50,000	\$50,000	—
Miscellaneous Revenues	\$(61,136)	—	\$2,223	—	—	—
Subtotal	\$1,649,771	\$150,400	\$152,623	\$150,400	\$150,400	—
Fund Balance	\$(1,137,898)	\$1,000,100	\$997,877	\$1,000,100	\$1,000,100	—
Total Source of Funds	\$511,873	\$1,150,500	\$1,150,500	\$1,150,500	\$1,150,500	—

Unit Description

This unit was established for the reuse of grant funds in the form of loans that are repaid. It currently includes the County's Small Business Revolving Loan Fund (RLF), which supports the expansion, retention, and attraction of small business, commerce, industry and agriculture in Monterey County.

The RLF is intended to help diversify and strengthen the economic base of the local area by assisting businesses that are unable to secure suitable private financing for start-up and expansion costs. RLF loans range in size from \$10,000 to \$250,000 and have created or helped retain more than 1,000 jobs since 1990.

Community Development Reuse

(Budget Unit 8517—Fund 013—Appropriation Unit CA0041)

Source of Funds

Intentionally Left Blank

Source of Funds

Revenues	Prior Year 2021-2022	Adopted Budget 2022-2023	CY Estimate 2022-2023	Requested Budget 2023-2024	Recommended Budget 2023-2024	Recommended Change from Adopted
Revenue from Use of Money & Property	\$5,486	—	—	—	—	—
Subtotal	\$5,486	—	—	—	—	—
Fund Balance	\$(5,486)	—	—	—	—	—
Total Source of Funds	—	—	—	—	—	—

Unit Description

This unit was moved to Housing and Community Development Department in Fiscal Year 2021-22.

This unit provides for the reuse of payments on loans that were originally funded by State Community Development Block Grant (CDBG) and HOME Investment Partnership program funds.

Grant funds are loaned to low and very low-income households for first-time homebuyer down payment assistance activities and to nonprofits for affordable housing projects. All program income must be spent on eligible activities in accordance with State regulations and adopted Program Income Reuse Plans and Guidelines.

Boronda HS-A

(Budget Unit 8519—Fund 176—Appropriation Unit CA0043)

Source of Funds

Intentionally Left Blank

Source of Funds

Revenues	Prior Year 2021-2022	Adopted Budget 2022-2023	CY Estimate 2022-2023	Requested Budget 2023-2024	Recommended Budget 2023-2024	Recommended Change from Adopted
Revenue from Use of Money & Property	\$48	—	—	—	—	—
Subtotal	\$48	—	—	—	—	—
Fund Balance	\$(48)	—	—	—	—	—
Total Source of Funds	—	—	—	—	—	—

Unit Description

This unit was moved to Housing and Community Development Department in Fiscal Year 2021-22.

The Boronda Housing Set-Aside provided Redevelopment funding for the provision of affordable housing to low and moderate-income families within the Boronda Redevelopment Project Area. In accordance with State law, all funds deposited into the Housing Set-

Aside Fund were used to increase the supply or improve the condition of very low, low, and moderate-income housing.

Since the State dissolution of Redevelopment Agencies and the loss of funds, the County took required actions to become the Housing Successor Agency. Any repayment of loans can be used to reinvest in housing.

Castro/Paj HS-A

(Budget Unit 8520—Fund 175—Appropriation Unit CAO044)

Use of Funds	Source of Funds
Intentionally Left Blank	Intentionally Left Blank

		Prior Year 2021-2022	Adopted Budget 2022-2023	CY Estimate 2022-2023	Requested Budget 2023-2024	Recommended Budget 2023-2024	Recommended Change from Adopted
Revenues							
Revenue from Use of Money & Property		\$72,460	—	—	—	—	—
Subtotal		\$72,460	—	—	—	—	—
Fund Balance		\$(72,460)	—	—	—	—	—
Total Source of Funds		—	—	—	—	—	—

Unit Description

This unit was moved to Housing and Community Development Department in Fiscal Year 2021-22.

The Castroville/Pajaro Housing Set-Aside unit was established to facilitate the provision of affordable housing to very low, low and moderate-income families within the Castroville/Pajaro Redevelopment Project Area. In accordance with Redevelopment

Law, all funds deposited into the Housing Set-Aside Fund were to be used to increase the supply or improve the condition of very low, low, and moderate-income housing.

Since the State’s dissolution of Redevelopment Agencies and the loss of funds, the County took required action to become the Housing Successor Agency. Any repayment of loans can be used to reinvest in housing.

Building Improvement and Replacement

(Budget Unit 8539—Fund 478—Appropriation Unit CA0047)

Use of Funds

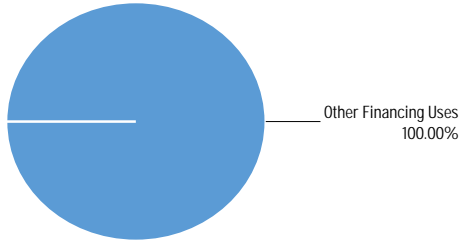

Source of Funds

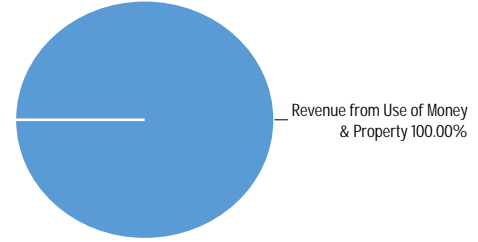

Use of Funds

Expenditures	Prior Year 2021-2022	Adopted Budget 2022-2023	CY Estimate 2022-2023	Requested Budget 2023-2024	Recommended Budget 2023-2024	Recommended Change from Adopted
Other Charges	\$(12,201,885)	\$(10,424,675)	\$(10,424,675)	\$(10,221,088)	\$(10,221,088)	\$203,587
Other Financing Uses	\$1,754,807	\$17,513,925	\$21,793,000	\$6,808,390	\$7,758,390	\$(9,755,535)
Subtotal	\$(10,447,078)	\$7,089,250	\$11,368,325	\$(3,412,698)	\$(2,462,698)	\$(9,551,948)

Source of Funds

Revenues	Prior Year 2021-2022	Adopted Budget 2022-2023	CY Estimate 2022-2023	Requested Budget 2023-2024	Recommended Budget 2023-2024	Recommended Change from Adopted
Revenue from Use of Money & Property	—	\$25,000	\$200,000	\$150,000	\$150,000	\$125,000
Miscellaneous Revenues	\$60,860	—	—	—	—	—
Other Financing Sources	\$4	—	—	—	—	—
Subtotal	\$60,864	\$25,000	\$200,000	\$150,000	\$150,000	\$125,000
Fund Balance	\$(10,507,942)	\$7,064,250	\$11,168,325	\$(3,562,698)	\$(2,612,698)	\$(9,676,948)
Total Source of Funds	\$(10,447,078)	\$7,089,250	\$11,368,325	\$(3,412,698)	\$(2,462,698)	\$(9,551,948)

Unit Description

The Building Improvement and Replacement (BIR) unit is a component of the Resource Planning Internal Service Fund (ISF). This unit is composed of the allocation of the building depreciation

overhead recovered through the County's annual Countywide Cost Allocation Plan (COWCAP). Depreciation is allocated among the County departments based on the square footage occupied. Funds are used to fund building improvement and replacement projects.

Equipment Replacement

(Budget Unit 8568—Fund 478—Appropriation Unit CA0048)

Use of Funds

Intentionally Left Blank

Source of Funds

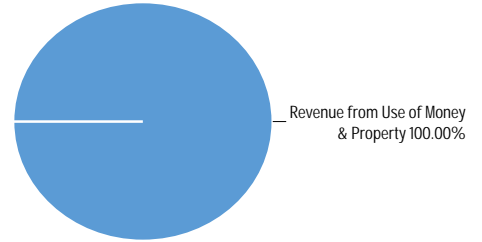

Use of Funds

Expenditures	Prior Year 2021-2022	Adopted Budget 2022-2023	CY Estimate 2022-2023	Requested Budget 2023-2024	Recommended Budget 2023-2024	Recommended Change from Adopted
Other Charges	\$(1,274,121)	\$(259,768)	\$(259,768)	\$(501,606)	\$(501,606)	\$(241,838)
Subtotal	\$(1,274,121)	\$(259,768)	\$(259,768)	\$(501,606)	\$(501,606)	\$(241,838)

Source of Funds

Revenues	Prior Year 2021-2022	Adopted Budget 2022-2023	CY Estimate 2022-2023	Requested Budget 2023-2024	Recommended Budget 2023-2024	Recommended Change from Adopted
Revenue from Use of Money & Property	—	\$5,000	\$10,000	\$15,000	\$15,000	\$10,000
Subtotal	—	\$5,000	\$10,000	\$15,000	\$15,000	\$10,000
Fund Balance	\$(1,274,121)	\$(264,768)	\$(269,768)	\$(516,606)	\$(516,606)	\$(251,838)
Total Source of Funds	\$(1,274,121)	\$(259,768)	\$(259,768)	\$(501,606)	\$(501,606)	\$(241,838)

Unit Description

The Equipment Replacement unit is a component of the Resource Planning Internal Service Fund (ISF). This unit is composed of the allocation of the equipment depreciation overhead recovered through the County's annual Countywide Cost Allocation Plan (COWCAP).

Depreciation is allocated among the County general fund departments using the straight-line method based on the assigned useful life of the asset. Funds are used to fund equipment improvement and replacement projects.

Pension Liability Fund

(Budget Unit 8570—Fund 030—Appropriation Unit CA0049)

Use of Funds

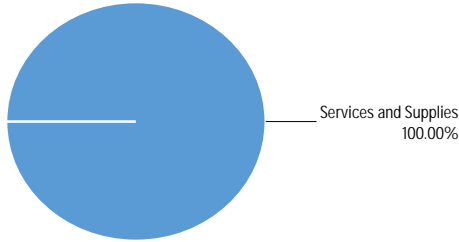

Source of Funds

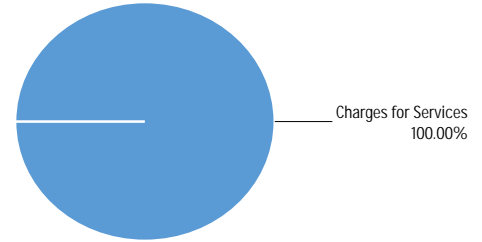

Use of Funds

Expenditures	Prior Year 2021-2022	Adopted Budget 2022-2023	CY Estimate 2022-2023	Requested Budget 2023-2024	Recommended Budget 2023-2024	Recommended Change from Adopted
Services and Supplies	\$45,859	—	\$250,000	\$300,000	\$300,000	\$300,000
Subtotal	\$45,859	—	\$250,000	\$300,000	\$300,000	\$300,000

Source of Funds

Revenues	Prior Year 2021-2022	Adopted Budget 2022-2023	CY Estimate 2022-2023	Requested Budget 2023-2024	Recommended Budget 2023-2024	Recommended Change from Adopted
Revenue from Use of Money & Property	\$(1,382,646)	—	\$1,400,000	—	—	—
Charges for Services	—	—	—	\$15,227,703	\$15,227,703	\$15,227,703
Other Financing Sources	\$9,986,815	\$15,402,538	\$30,805,076	—	—	\$(15,402,538)
Subtotal	\$8,604,169	\$15,402,538	\$32,205,076	\$15,227,703	\$15,227,703	\$(174,835)
Fund Balance	\$(8,558,310)	\$(15,402,538)	\$(31,955,076)	\$(14,927,703)	\$(14,927,703)	\$474,835
Total Source of Funds	\$45,859	—	\$250,000	\$300,000	\$300,000	\$300,000

Unit Description

This Pension Liability Fund was established for the collection of unfunded accrued liability (UAL) supplemental pension payments and discretionary revenue contributions to address the County's

unfunded pension liability. Contributions from the supplemental payments are held in a Section 115 Trust with an external trust administrator.

Human Resources

Departmental Overview:

The Human Resources Department's primary duties include handling the employment process, classification and compensation, managing employee benefits programs, maintaining employee records, coordinating employee training, labor relations, employee counseling on rights and personnel matters, and conducting human resources strategic planning.

Programs and Functions:

The Administration Division is responsible for countywide human resources leadership, direction, and support through the promulgation of policies, the performance of liaison activities with County departments and other agencies, processing of public inquiries and information requests, logistics support, gathering and analyzing data, performing research and analysis, and developing programs.

The Employee and Labor Relations Division researches, negotiates, implements and enforces labor agreements, trains supervisors and managers, and represents the County in the meet and confer process, grievances, and in disciplinary matters.

The Employment Services Division utilizes a variety of methods and strategies to attract, recruit, and employ a talented and diverse workforce that delivers essential services to the public. This division also provides and monitors a competitive and fair compensation system and maintains a standardized and equitable classification system.

The Employee Benefits Division administers a full range of benefit programs and services to eligible employees, retirees, and their dependents.

The HR Information Systems Division supports all County departments through the implementation of secure and effective processes and technologies in areas such as data management, reporting and analysis, workforce management, recruiting, compensation, benefits administration, and compliance.

Department's Contributions to Monterey County's Strategic Initiatives:

ECONOMIC DEVELOPMENT

Ensure County employees receive a competitive salary and benefits package to thrive, live, and grow in our community.

ADMINISTRATION

Attract, employ, develop, and retain a diverse and talented workforce to serve our community.

HEALTH AND HUMAN SERVICES

Collaborate with our healthcare professionals in support of creating and developing programs that promote healthy work environments and lifestyles.

PUBLIC SAFETY

Provide a work atmosphere that is safe, healthy, and secure.



Operating Budget: \$15,100,658
Positions (FTEs): 42.00

Irma Ramirez-Bough
Human Resources Director

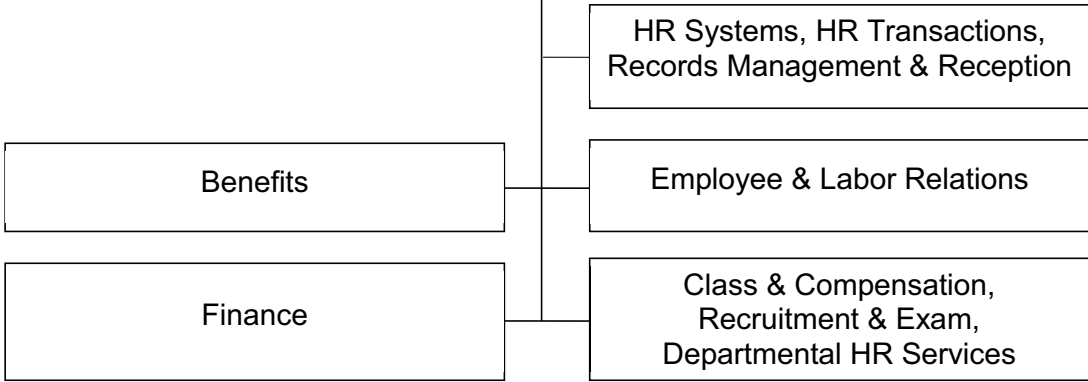

Staffing Trends

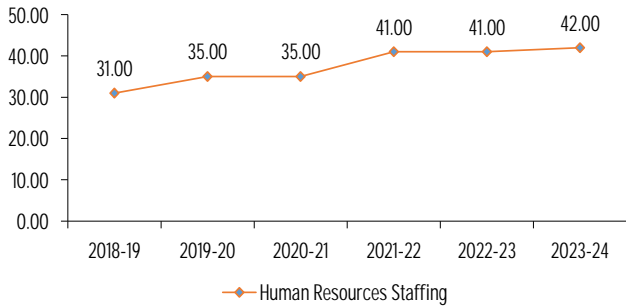

Expenditure/Revenue History (in millions)

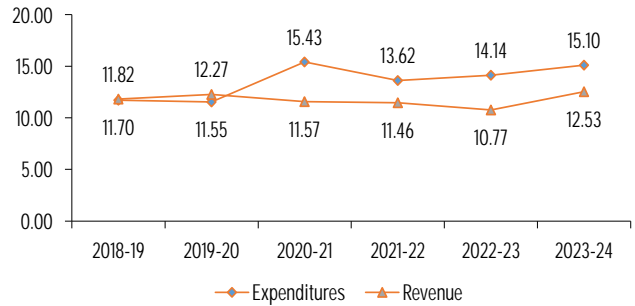

The Human Resources Department develops and delivers human resources services and programs designed to support the strategic initiatives of the County.

Key Performance Measures	2020-21 Actual	2021-22 Actual	2022-23 Mid-Year
Number of recruitments conducted.	255	282	94
Number of applications received.	15,375	13,290	6,214
Number of new hires (permanent and temporary employees).	849	851	455
Number of promotions (competitive, flexible, and reclassifications).	492	695	316
Number of voluntary separations (retirement and resignation).	498	594	285

Use of Funds

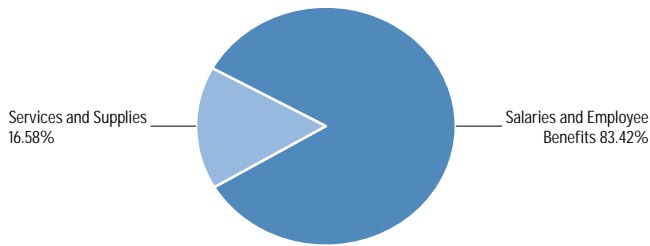

Source of Funds

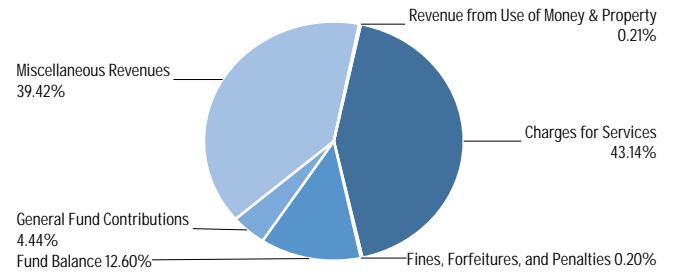

Use of Funds

Expenditures	Prior Year 2021-2022	Adopted Budget 2022-2023	CY Estimate 2022-2023	Requested Budget 2023-2024	Recommended Budget 2023-2024	Recommended Change from Adopted
Salaries and Employee Benefits	\$11,418,349	\$12,269,308	\$12,303,786	\$13,119,449	\$12,766,699	\$497,391
Services and Supplies	\$1,933,644	\$2,205,308	\$1,873,413	\$2,626,268	\$2,537,813	\$332,505
Other Charges	\$265,254	\$1,483,227	\$(47,338)	\$(209,804)	\$(209,804)	\$(1,693,031)
Capital Assets	—	—	\$5,358	\$5,950	\$5,950	\$5,950
Subtotal	\$13,617,246	\$15,957,843	\$14,135,219	\$15,541,863	\$15,100,658	\$(857,185)

Source of Funds

Revenues	Prior Year 2021-2022	Adopted Budget 2022-2023	CY Estimate 2022-2023	Requested Budget 2023-2024	Recommended Budget 2023-2024	Recommended Change from Adopted
Fines, Forfeitures, and Penalties	\$46,836	\$30,000	\$30,000	\$30,000	\$30,000	—
Revenue from Use of Money & Property	\$39,675	\$30,900	\$60,906	\$31,200	\$31,200	\$300
Charges for Services	\$6,305,036	\$6,292,887	\$6,239,903	\$6,513,999	\$6,513,999	\$221,112
Miscellaneous Revenues	\$5,065,859	\$5,314,443	\$4,435,716	\$5,953,350	\$5,953,350	\$638,907
Subtotal	\$11,457,407	\$11,668,230	\$10,766,525	\$12,528,549	\$12,528,549	\$860,319
Fund Balance	\$1,363,548	\$2,819,207	\$2,244,177	\$1,902,282	\$1,902,282	\$(916,925)
General Fund Contributions	\$796,291	\$1,470,406	\$1,124,517	\$1,111,032	\$669,827	\$(800,579)
Total Source of Funds	\$13,617,246	\$15,957,843	\$14,135,219	\$15,541,863	\$15,100,658	\$(857,185)

Summary of Recommendation

The Recommended Budget for the Human Resources Department is \$15,100,658 in appropriations with total expenditures of \$22,929,462, financed by \$12,528,549 in revenue, \$6,369,466 in cost plan credits, \$1,459,358 in interfund reimbursements, \$1,902,282 in fund balance, and a general fund contribution of \$669,827. The Recommended Budget represents an appropriation decrease of \$857,185 compared to the FY 2022-23 Adopted Budget due to a decrease in unemployment insurance claims and OPEB contributions. The Recommended Budget reflects a revenue increase of \$860,319 compared to the FY 2022-23 Adopted Budget from higher employee benefit program premiums. The estimated use of \$1,902,282 in fund balance results from the costs of benefits exceeding revenues, which is purposely budgeted to reduce the surplus fund balance.

The Recommended Budget includes 42 positions. During FY 2022-23, a Management Analyst III position was reallocated to an HR Program Manager position and an Associate Personnel Analyst position was reallocated to a Management Analyst II position. The FY 2023-24 Recommended Budget includes four new positions to serve as Enterprise Resource Program (ERP) backfills; these four

positions will be funded by the ERP sub-fund. An Associate Personnel Analyst and a Personnel Technician-Confidential positions were transferred from the Human Resources Department to the Public Works, Facilities, and Parks Department.

Budget Impacts

Due to increased personnel costs, an HR Program Manager position in the Employee and Labor Relations Division was removed from the Recommended Budget to balance the budget. Augmentation requests for the HR Program Manager position and a new Risk & Benefits Specialist-Confidential position were requested to provide funding to maintain current levels of service. The Recommended Budget does not include funding for these positions.

Prior Year Accomplishments

Worked in collaboration with Salinas Unified High School District to host career exploration fairs at high schools.

Collaborated with LGBTQ+ Employee Resource Group to promote County career opportunities at the Monterey Peninsula Pride event.

Attended career fairs at California State University Monterey Bay, Hartnell College, and Monterey Peninsula College (MPC).

Partnered with the Information Technology Department to develop and launch the following programs: Electronic Personnel Action Form (EPAF), Employee Relations Tracker, Electronic Class and Comp Request to Classify (RTC) Form, Human Resources Services Tracker, Disaster Service Worker Management Portal, On-Boarding Portal, and the Recruitment Subject Matter Expert Database.

Updated the following policies: Compensation Philosophy, Staff Mobile and Wireless Device Policy, COVID-19 policies and procedures, and Personnel Policies and Practices Resolutions (PPPR) amendments (e.g., Employment Bonus Program, Additional Pay for Employees in Exempt Classifications, Employee Wellbeing and Work-Life Resources Paid Leave).

Conducted 48 classification and base wage compensation studies, of which 23 were completed by Natividad and reviewed and approved by the HR Department.

Successfully negotiated multi-year agreements with all of the County's bargaining units, including the three newly recognized employee groups.

Successfully rolled out and implemented the expansion of the Blue Shield HMO TRIO plan in the Monterey County region.

Partnered with Blue Shield to offer three virtual open enrollment fairs to provide plan design and benefits to employees.

Completed 3/4 of the Americans with Disabilities Act (ADA) instructional user guide for reasonable accommodation requests countywide and is under review.

Held webinars in conjunction with Nationwide, the plan administrator for the Monterey County Deferred Compensation Plan.

Added leadership development resources and Take the Lead videos created by employees to the Leadership Learning Exchange website.

Created an online comprehensive Stay Interview Toolkit to support leaders in retaining employees.

The first-ever Employee Appreciation Day celebration was launched in March 2023 to honor employees during this annual national event.

Increased the number of BetterUp coaching licenses; initially purchased 36 in year one and then 63 licenses in year two.

Conducted three surveys in 2022: "Intent to Stay," "New Hire and Onboarding," and "Former Employees who Retired and Resigned."

Completed the development, review, and finalized human resources, position control, and benefit system requirements in support of the replacement of the ERP system.

Budget Year Goals

Host career exploration fairs with Salinas Unified High School District high schools.

Partner with departments to create videos highlighting the County of Monterey's diverse career paths.

Continue collaboration with our local educational institutions and community partners (e.g., Employment Development Department, disabled and veterans organizations) to participate in internships and career fairs.

Partner with Department Heads through committees to explore and implement initiatives to target recruitment and retention efforts and employee engagement.

Continue collaboration with Health, Social Services, Natividad, and California State University Monterey Bay to establish a Bachelor's in Social Work in conjunction with an accelerated Master's Degree in Social Work.

Update the Human Resources Department's Strategic Plan.

Review the flexible staffing program and identify needed changes to guidelines and procedures to ensure the program is effective in meeting the County's operational needs.

Review, streamline and enable online completion of the Position Description Questionnaire (PDQ) form.

Carefully monitor CalPERS' further expansion of medical plans to coordinate implementation.

Complete and distribute the Americans with Disabilities Act (ADA) instructional user guide for reasonable accommodation requests countywide.

Pursue the implementation of State Disability Insurance (SDI) for the management and non-represented groups to be more consistent with other groups and restructure the Short-Term Disability Plan for applicable said groups.

Offer Leadership Learning Exchange (LLE) webinars to promote the LLE and support employees at all levels in leveraging this online leadership development resource.

Identify additional departments to pilot the Stay Interview Toolkit before launching Countywide.

Collaborate with departments to develop a policy and obtain the Board of Supervisors' approval to launch a Countywide initiative based on the U.S. Surgeon General's model for Workplace Mental Health and Wellbeing.

Coordinate activities/events to celebrate three annual events to honor employees: Employee Appreciation Day, Public Service Recognition Week, and Customer Service Week.

Design, implement, and deploy the Perform electronic performance evaluation system in Fall 2023.

Provide training and system support to all users to maximize user acceptance of the County's Perform system rollout. Partner with the Information Technology Department to design and deploy the Human Resources Department (HRD) Document Management system (DMS) to enable electronic storage of Personnel and Recruitment files.

Human Resources Information Systems will implement, test, and validate the Human Capital Management modules to include personnel, position control, and benefits management.

Pending Issues

There are no pending issues.

Policy Considerations

There are no policy considerations.

Appropriation Expenditure Detail

	Prior Year 2021-2022	Adopted Budget 2022-2023	CY Estimate 2022-2023	Requested Budget 2023-2024	Recommended Budget 2023-2024	Recommended Change from Adopted	Fund Code	Budget Unit Code
Employee & Labor Relations (HRD001)	770,739	824,349	643,250	926,724	700,009	(124,340)	001	8401
Employment Services (HRD001)	2,980,124	3,307,097	3,113,372	2,950,318	2,950,318	(356,779)	001	8402
Employee Benefits (HRD001)	635,966	668,662	713,770	877,604	751,569	82,907	001	8404
Dental (HRD002)	5,178,819	6,830,301	5,679,276	6,480,067	6,480,067	(350,234)	477	8413
Vision (HRD002)	939,162	1,054,103	912,733	1,156,440	1,156,440	102,337	477	8414
Employee Assistance Program (HRD002)	103,032	106,920	101,574	106,920	106,920	0	477	8415
Disability (HRD002)	397,655	396,946	408,306	463,753	463,753	66,807	477	8416
Unemployment (HRD002)	507,322	736,323	471,438	636,362	636,362	(99,961)	477	8417
Misc Benefits (HRD002)	986,920	427,937	513,815	874,163	874,163	446,226	477	8418
Other Post-Employment Benefits (HRD002)	4,708,045	4,934,907	4,923,560	4,713,126	4,713,126	(221,781)	477	8419
Human Resources Administration (HRD001)	(4,150,643)	(3,953,995)	(3,945,645)	(4,422,935)	(4,422,935)	(468,940)	001	8445
HR Information System (HRD001)	560,105	624,293	599,770	779,321	690,866	66,573	001	8496
Subtotal	\$13,617,246	\$15,957,843	\$14,135,219	\$15,541,863	\$15,100,658	\$(857,185)		

Budget Units

	Prior Year 2021-2022	Adopted Budget 2022-2023	CY Estimate 2022-2023	Requested Budget 2023-2024	Recommended Budget 2023-2024	Recommended Change from Adopted
Employee & Labor Relations	\$770,739	\$824,349	\$643,250	\$926,724	700,009	\$(124,340)
Employment Services	\$2,980,124	\$3,307,097	\$3,113,372	\$2,950,318	2,950,318	\$(356,779)
Employee Benefits	\$635,966	\$668,662	\$713,770	\$877,604	751,569	\$82,907
Dental	\$5,178,819	\$6,830,301	\$5,679,276	\$6,480,067	6,480,067	\$(350,234)
Vision	\$939,162	\$1,054,103	\$912,733	\$1,156,440	1,156,440	\$102,337
Employee Assistance Program	\$103,032	\$106,920	\$101,574	\$106,920	106,920	—
Disability	\$397,655	\$396,946	\$408,306	\$463,753	463,753	\$66,807
Unemployment	\$507,322	\$736,323	\$471,438	\$636,362	636,362	\$(99,961)
Misc Benefits	\$986,920	\$427,937	\$513,815	\$874,163	874,163	\$446,226
Other Post-Employment Benefits	\$4,708,045	\$4,934,907	\$4,923,560	\$4,713,126	4,713,126	\$(221,781)
Human Resources Administration	\$(4,150,643)	\$(3,953,995)	\$(3,945,645)	\$(4,422,935)	(4,422,935)	\$(468,940)
HR Information System	\$560,105	\$624,293	\$599,770	\$779,321	690,866	\$66,573
Subtotal	\$13,617,246	\$15,957,843	\$14,135,219	\$15,541,863	\$15,100,658	\$(857,185)

Adopted FY 2022-23 to Recommended FY 2023-24 Positions

Classification Code	Classification Label	Adopted Budget 2021-2022	Adopted Budget 2022-2023	Recommended Budget 2023-2024	Change
11A07	DIRECTOR OF HUMAN RESOURCES	1.00	1.00	1.00	0.00
12C37	ASSISTANT DIRECTOR OF HUMAN RESOURCES	1.00	2.00	2.00	0.00
14B21	ASSOCIATE PERSONNEL ANALYST	13.00	13.00	12.00	(1.00)
14B28	SUPERVISING PERSONNEL ANALYST	1.00	1.00	1.00	0.00
14B32	SENIOR PERSONNEL ANALYST	5.00	5.00	5.00	0.00
14B60	RISK & BENEFITS SPECIALIST-CONFIDENTIAL	1.00	1.00	1.00	0.00

Adopted FY 2022-23 to Recommended FY 2023-24 Positions

Classification Code	Classification Label	Adopted Budget 2021-2022	Adopted Budget 2022-2023	Recommended Budget 2023-2024	Change
14B62	ASSOCIATE RISK & BENEFITS ANALYST	2.00	2.00	2.00	0.00
14B63	SENIOR RISK & BENEFITS ANALYST	1.00	1.00	2.00	1.00
14C30	MANAGEMENT ANALYST II	1.00	1.00	2.00	1.00
14C31	MANAGEMENT ANALYST III	3.00	3.00	2.00	(1.00)
14G02	MANAGEMENT ANALYST I	0.00	1.00	1.00	0.00
14H03	PERSONNEL TECHNICIAN-CONFIDENTIAL	5.00	5.00	4.00	(1.00)
14M61	HR PROGRAM MANAGER	4.00	3.00	5.00	2.00
20B93	FINANCE MANAGER II	1.00	1.00	1.00	0.00
80A99	ADMINISTRATIVE SECRETARY-CONFIDENTIAL	1.00	0.00	0.00	0.00
80J30	ACCOUNTING TECHNICIAN	1.00	1.00	1.00	0.00
Total		41.00	41.00	42.00	1.00

Augmentation Requests

Request Code	Request Name	Ranking Type Name	Requested Amount	Requested FTE	Recommended Budget	Recommended FTE
1060-8401-001-AUG1	Status Quo Vacant HR Program Manager	Status Quo Vacant Position	226,715	1.00	-	-
1060-8401-001-AUG2	Legal Services for Labor Negotiations	Status Quo Other	50,000	-	50,000	-
1060-8401-001-AUG5	ERP Backfill HR Program Manager	ERP Replacement Project Backfill	-	1.00	-	1.00
1060-8404-001-AUG7	ERP Backfill Senior Risk & Benefits Analyst	ERP Replacement Project Backfill	-	1.00	-	1.00
1060-8404-001-AUG9	New Risk & Benefits Specialist-Conf.	Request New Position	126,035	1.00	-	-
1060-8496-001-AUG3	Qualtrics Agreement	New Program/Service w/ General Fund Funding	88,455	-	-	-
1060-8496-001-AUG6	ERP Backfill HR Program Manager	ERP Replacement Project Backfill	-	1.00	-	1.00
1060-8496-001-AUG8	ERP Backfill Associate Personnel Analyst	ERP Replacement Project Backfill	-	1.00	-	1.00
Grand Total:			\$491,205	6.00	\$50,000	4.00

Human Resources Departmental

Use of Funds

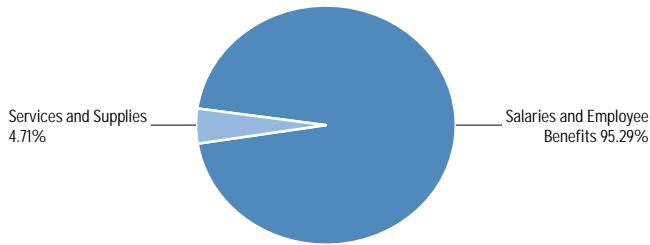

Source of Funds

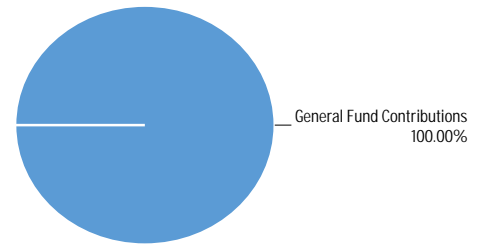

Use of Funds

Expenditures	Prior Year 2021-2022	Adopted Budget 2022-2023	CY Estimate 2022-2023	Requested Budget 2023-2024	Recommended Budget 2023-2024	Recommended Change from Adopted
Salaries and Employee Benefits	\$6,367,933	\$7,393,308	\$7,010,780	\$8,475,449	\$8,122,699	\$729,391
Services and Supplies	\$450,742	\$312,620	\$314,545	\$489,920	\$401,465	\$88,845
Other Charges	\$(6,022,384)	\$(6,235,522)	\$(6,206,166)	\$(7,860,287)	\$(7,860,287)	\$(1,624,765)
Capital Assets	—	—	\$5,358	\$5,950	\$5,950	\$5,950
Subtotal	\$796,291	\$1,470,406	\$1,124,517	\$1,111,032	\$669,827	\$(800,579)

Source of Funds

Revenues	Prior Year 2021-2022	Adopted Budget 2022-2023	CY Estimate 2022-2023	Requested Budget 2023-2024	Recommended Budget 2023-2024	Recommended Change from Adopted
General Fund Contributions	\$796,291	\$1,470,406	\$1,124,517	\$1,111,032	\$669,827	\$(800,579)
Total Source of Funds	\$796,291	\$1,470,406	\$1,124,517	\$1,111,032	\$669,827	\$(800,579)

Division Description

The Human Resources departmental section includes Employee and Labor Relations, Employment Services, Employee Benefits, HR Administration, and HR Information Systems. Responsibilities and programs for each of these divisions are detailed in their budget unit description.

Summary of Recommendation

The Recommended Budget for the Human Resources departmental units is \$669,827, which reflects \$8,530,114 in expenditures and \$7,860,287 in reimbursements from the Countywide Cost Allocation Plan (COWCAP), Enterprise Resource Planning sub-fund, and Benefit Programs internal service fund. The Recommended Budget reflects a decrease of \$800,579 in expenditures compared to the FY 2022-23 Adopted Budget due to the increase in the COWCAP reimbursements.

Appropriation Expenditure Detail

	Prior Year 2021-2022	Adopted Budget 2022-2023	CY Estimate 2022-2023	Requested Budget 2023-2024	Recommended Budget 2023-2024	Recommended Change from Adopted	Fund Code	Budget Unit Code
Employee & Labor Relations (HRD001)	770,739	824,349	643,250	926,724	700,009	(124,340)	001	8401
Employment Services (HRD001)	2,980,124	3,307,097	3,113,372	2,950,318	2,950,318	(356,779)	001	8402
Employee Benefits (HRD001)	635,966	668,662	713,770	877,604	751,569	82,907	001	8404
Human Resources Administration (HRD001)	(4,150,643)	(3,953,995)	(3,945,645)	(4,422,935)	(4,422,935)	(468,940)	001	8445
HR Information System (HRD001)	560,105	624,293	599,770	779,321	690,866	66,573	001	8496
Subtotal	796,291	1,470,406	1,124,517	1,111,032	669,827	(800,579)		

Employee & Labor Relations

(Budget Unit 8401—Fund 001—Appropriation Unit HRD001)

Use of Funds

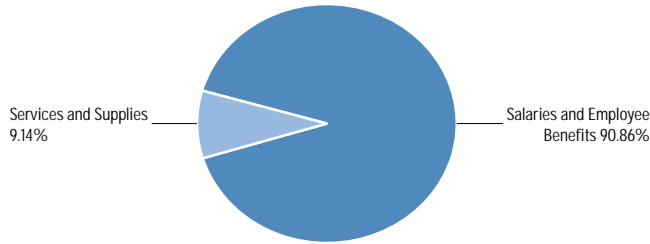

Source of Funds

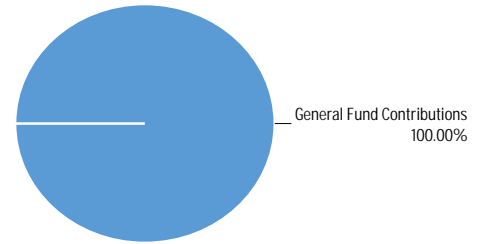

Use of Funds

Expenditures	Prior Year 2021-2022	Adopted Budget 2022-2023	CY Estimate 2022-2023	Requested Budget 2023-2024	Recommended Budget 2023-2024	Recommended Change from Adopted
Salaries and Employee Benefits	\$685,339	\$808,715	\$631,063	\$1,068,249	\$841,534	\$32,819
Services and Supplies	\$85,400	\$15,634	\$11,731	\$84,690	\$84,690	\$69,056
Other Charges	—	—	—	\$(226,715)	\$(226,715)	\$(226,715)
Capital Assets	—	—	\$456	\$500	\$500	\$500
Subtotal	\$770,739	\$824,349	\$643,250	\$926,724	\$700,009	\$(124,340)

Source of Funds

Revenues	Prior Year 2021-2022	Adopted Budget 2022-2023	CY Estimate 2022-2023	Requested Budget 2023-2024	Recommended Budget 2023-2024	Recommended Change from Adopted
General Fund Contributions	\$770,739	\$824,349	\$643,250	\$926,724	\$700,009	\$(124,340)
Total Source of Funds	\$770,739	\$824,349	\$643,250	\$926,724	\$700,009	\$(124,340)

Unit Description

To promote a high-quality workforce, the Employee and Labor Relations Division is responsible for fostering a positive employer/employee work environment by promoting collaborative relationships between employees, management, and employee organizations. Employee and Labor Relations is responsible for administering 13 labor agreements for 20 bargaining units, resolving contract disputes, interpreting statutes and policies, and providing guidance, training and recommendations pertaining to performance management and progressive discipline.

Recommended FY 2023-24 Positions

Classification Code	Classification Label	FTE
14B21	ASSOCIATE PERSONNEL ANALYST	1.00
14B32	SENIOR PERSONNEL ANALYST	2.00
14M61	HUMAN RESOURCES PROGRAM MANAGER	1.00
Total		4.00

Employment Services

(Budget Unit 8402—Fund 001—Appropriation Unit HRD001)

Use of Funds

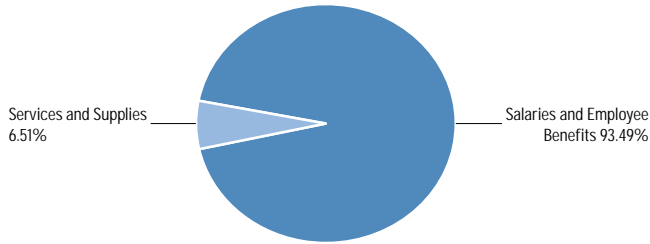

Source of Funds

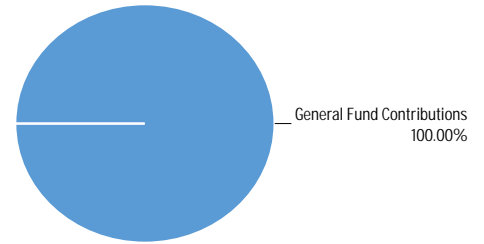

Use of Funds

Expenditures	Prior Year 2021-2022	Adopted Budget 2022-2023	CY Estimate 2022-2023	Requested Budget 2023-2024	Recommended Budget 2023-2024	Recommended Change from Adopted
Salaries and Employee Benefits	\$2,712,978	\$3,122,265	\$2,924,925	\$2,755,936	\$2,755,936	\$(366,329)
Services and Supplies	\$267,146	\$184,832	\$186,129	\$191,882	\$191,882	\$7,050
Capital Assets	—	—	\$2,318	\$2,500	\$2,500	\$2,500
Subtotal	\$2,980,124	\$3,307,097	\$3,113,372	\$2,950,318	\$2,950,318	\$(356,779)

Source of Funds

Revenues	Prior Year 2021-2022	Adopted Budget 2022-2023	CY Estimate 2022-2023	Requested Budget 2023-2024	Recommended Budget 2023-2024	Recommended Change from Adopted
General Fund Contributions	\$2,980,124	\$3,307,097	\$3,113,372	\$2,950,318	\$2,950,318	\$(356,779)
Total Source of Funds	\$2,980,124	\$3,307,097	\$3,113,372	\$2,950,318	\$2,950,318	\$(356,779)

Unit Description

The Employment Services Division provides innovative, responsive, fair and consistent recruitment selection services to County departments, employees, and job applicants to ensure the County employs a qualified and diverse workforce that delivers essential services to the community. This division provides and monitors a competitive and fair compensation system and maintains a standardized and equitable classification system which defines the scope and nature of job assignments, provides ongoing updates of classification specifications, identifies job expectations, and supports career development options which enables the County to employ and retain qualified employees.

Recommended FY 2023-24 Positions

Classification Code	Classification Label	FTE
14B21	ASSOCIATE PERSONNEL ANALYST	9.00
14B28	SUPERVISING PERSONNEL ANALYST	1.00
14B32	SENIOR PERSONNEL ANALYST	2.00
14H03	PERSONNEL TECHNICIAN-CONFIDENTIAL	2.00
14M61	HUMAN RESOURCES PROGRAM MANAGER	1.00
Total		15.00

Employee Benefits

(Budget Unit 8404—Fund 001—Appropriation Unit HRD001)

Use of Funds

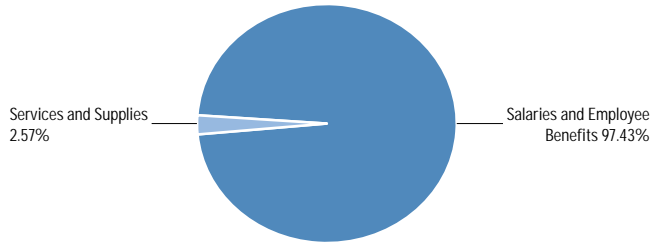

Source of Funds

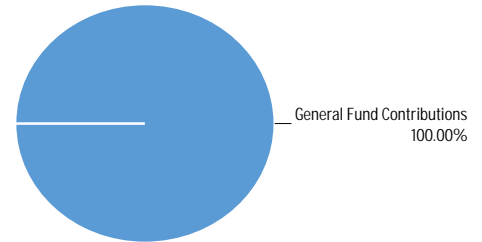

Use of Funds

Expenditures	Prior Year 2021-2022	Adopted Budget 2022-2023	CY Estimate 2022-2023	Requested Budget 2023-2024	Recommended Budget 2023-2024	Recommended Change from Adopted
Salaries and Employee Benefits	\$966,207	\$1,046,870	\$1,047,635	\$1,416,836	\$1,290,801	\$243,931
Services and Supplies	\$24,879	\$28,534	\$29,647	\$33,991	\$33,991	\$5,457
Other Charges	\$(355,121)	\$(406,742)	\$(364,272)	\$(574,023)	\$(574,023)	\$(167,281)
Capital Assets	—	—	\$760	\$800	\$800	\$800
Subtotal	\$635,966	\$668,662	\$713,770	\$877,604	\$751,569	\$82,907

Source of Funds

Revenues	Prior Year 2021-2022	Adopted Budget 2022-2023	CY Estimate 2022-2023	Requested Budget 2023-2024	Recommended Budget 2023-2024	Recommended Change from Adopted
General Fund Contributions	\$635,966	\$668,662	\$713,770	\$877,604	\$751,569	\$82,907
Total Source of Funds	\$635,966	\$668,662	\$713,770	\$877,604	\$751,569	\$82,907

Unit Description

The Employee Benefits Division administers the County's comprehensive benefit programs, provides benefits education, and helps resolve benefits-related problems for employees, retirees, and family members.

Recommended FY 2023-24 Positions

Classification Code	Classification Label	FTE
14B32	SENIOR PERSONNEL ANALYST	1.00
14B60	RISK & BENEFITS SPECIALIST-CONFIDENTIAL	1.00
14B62	ASSOCIATE RISK & BENEFITS ANALYST	2.00
14B63	SENIOR RISK & BENEFITS ANALYST	2.00
14M61	HUMAN RESOURCES PROGRAM MANAGER	1.00
Total		7.00

Human Resources Administration

(Budget Unit 8445—Fund 001—Appropriation Unit HRD001)

Use of Funds

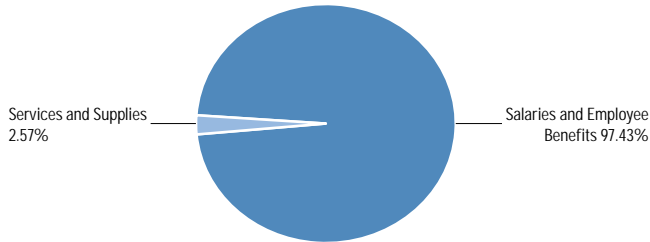

Source of Funds

Intentionally Left Blank

Use of Funds

Expenditures	Prior Year 2021-2022	Adopted Budget 2022-2023	CY Estimate 2022-2023	Requested Budget 2023-2024	Recommended Budget 2023-2024	Recommended Change from Adopted
Salaries and Employee Benefits	\$1,457,839	\$1,837,909	\$1,839,101	\$2,175,725	\$2,175,725	\$337,816
Services and Supplies	\$42,715	\$36,876	\$40,932	\$57,450	\$57,450	\$20,574
Other Charges	\$(5,651,197)	\$(5,828,780)	\$(5,826,894)	\$(6,657,610)	\$(6,657,610)	\$(828,830)
Capital Assets	—	—	\$1,216	\$1,500	\$1,500	\$1,500
Subtotal	\$(4,150,643)	\$(3,953,995)	\$(3,945,645)	\$(4,422,935)	\$(4,422,935)	\$(468,940)

Source of Funds

Revenues	Prior Year 2021-2022	Adopted Budget 2022-2023	CY Estimate 2022-2023	Requested Budget 2023-2024	Recommended Budget 2023-2024	Recommended Change from Adopted
General Fund Contributions	\$(4,150,643)	\$(3,953,995)	\$(3,945,645)	\$(4,422,935)	\$(4,422,935)	\$(468,940)
Total Source of Funds	\$(4,150,643)	\$(3,953,995)	\$(3,945,645)	\$(4,422,935)	\$(4,422,935)	\$(468,940)

Unit Description

The Human Resources Administration Division is responsible for countywide human resources leadership, direction, and support through the promulgation of policies, performance of liaison activities with County departments and other agencies, processing of public inquiries and information requests, logistics support, gathering and analyzing data, performing research and analysis, and developing programs. Other responsibilities include ensuring compliance with legal mandates, minimizing liability related to personnel functions, and maintaining of policies and procedures. The division provides staff support to the Board of Supervisors' Human Resources Committee. This division includes the finance section, which provides support to all divisions within the department and is responsible for budget development and management, contract development and management, and Benefit Programs Fund management. Daily financial departmental support includes accounts

payable, accounts receivable, payroll, purchase requisitions, expense reimbursements, and cost accounting.

Recommended FY 2023-24 Positions

Classification Code	Classification Label	FTE
11A07	DIRECTOR OF HUMAN RESOURCES	1.00
12C37	ASSISTANT DIRECTOR OF HUMAN RESOURCES	2.00
14C30	MANAGEMENT ANALYST II	2.00
14C31	MANAGEMENT ANALYST III	2.00
14G02	MANAGEMENT ANALYST I	1.00
20B93	FINANCE MANAGER II	1.00
80J30	ACCOUNTING TECHNICIAN	1.00
Total		10.00

HR Information System

(Budget Unit 8496—Fund 001—Appropriation Unit HRD001)

Use of Funds

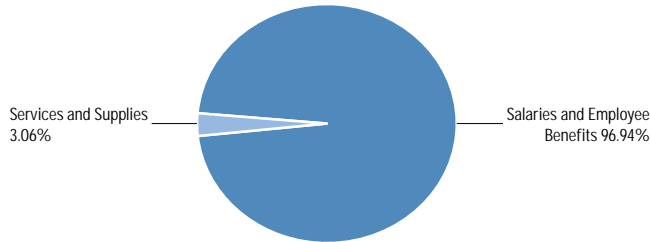

Source of Funds

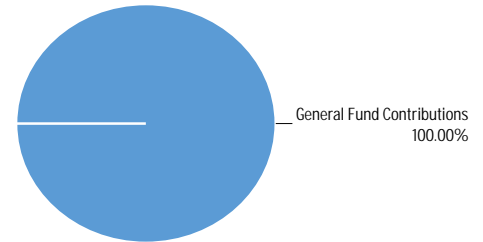

Use of Funds

Expenditures	Prior Year 2021-2022	Adopted Budget 2022-2023	CY Estimate 2022-2023	Requested Budget 2023-2024	Recommended Budget 2023-2024	Recommended Change from Adopted
Salaries and Employee Benefits	\$545,571	\$577,549	\$568,056	\$1,058,703	\$1,058,703	\$481,154
Services and Supplies	\$30,601	\$46,744	\$46,106	\$121,907	\$33,452	\$(13,292)
Other Charges	\$(16,066)	—	\$(15,000)	\$(401,939)	\$(401,939)	\$(401,939)
Capital Assets	—	—	\$608	\$650	\$650	\$650
Subtotal	\$560,105	\$624,293	\$599,770	\$779,321	\$690,866	\$66,573

Source of Funds

Revenues	Prior Year 2021-2022	Adopted Budget 2022-2023	CY Estimate 2022-2023	Requested Budget 2023-2024	Recommended Budget 2023-2024	Recommended Change from Adopted
General Fund Contributions	\$560,105	\$624,293	\$599,770	\$779,321	\$690,866	\$66,573
Total Source of Funds	\$560,105	\$624,293	\$599,770	\$779,321	\$690,866	\$66,573

Unit Description

The HR Information Systems Division supports the strategic vision of the County through the implementation of secure and effective processes and technologies in areas such as data management, reporting and analysis, workforce management, recruiting, compensation, benefits administration and compliance.

Recommended FY 2023-24 Positions

Classification Code	Classification Label	FTE
14B21	ASSOCIATE PERSONNEL ANALYST	2.00
14H03	PERSONNEL TECHNICIAN- CONFIDENTIAL	2.00
14M61	HUMAN RESOURCES PROGRAM MANAGER	2.00
Total		6.00

Human Resources Non-Departmental

Use of Funds

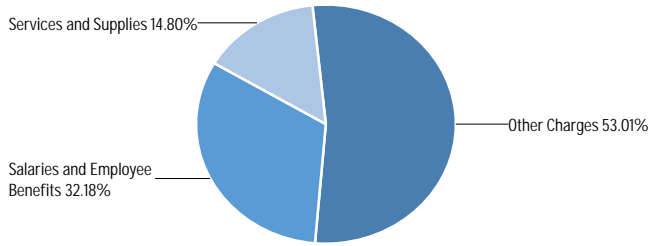

Source of Funds

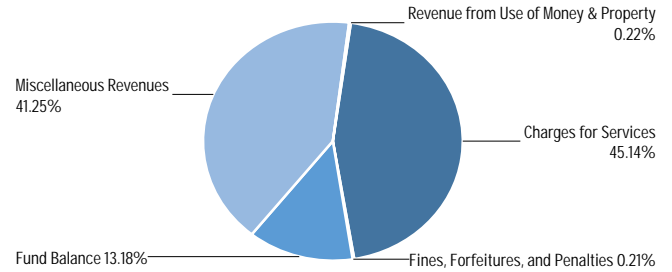

Use of Funds

Expenditures	Prior Year 2021-2022	Adopted Budget 2022-2023	CY Estimate 2022-2023	Requested Budget 2023-2024	Recommended Budget 2023-2024	Recommended Change from Adopted
Salaries and Employee Benefits	\$5,050,415	\$4,876,000	\$5,293,006	\$4,644,000	\$4,644,000	\$(232,000)
Services and Supplies	\$1,482,902	\$1,892,688	\$1,558,868	\$2,136,348	\$2,136,348	\$243,660
Other Charges	\$6,287,638	\$7,718,749	\$6,158,828	\$7,650,483	\$7,650,483	\$(68,266)
Subtotal	\$12,820,956	\$14,487,437	\$13,010,702	\$14,430,831	\$14,430,831	\$(56,606)

Source of Funds

Revenues	Prior Year 2021-2022	Adopted Budget 2022-2023	CY Estimate 2022-2023	Requested Budget 2023-2024	Recommended Budget 2023-2024	Recommended Change from Adopted
Fines, Forfeitures, and Penalties	\$46,836	\$30,000	\$30,000	\$30,000	\$30,000	—
Revenue from Use of Money & Property	\$39,675	\$30,900	\$60,906	\$31,200	\$31,200	\$300
Charges for Services	\$6,305,036	\$6,292,887	\$6,239,903	\$6,513,999	\$6,513,999	\$221,112
Miscellaneous Revenues	\$5,065,859	\$5,314,443	\$4,435,716	\$5,953,350	\$5,953,350	\$638,907
Subtotal	\$11,457,407	\$11,668,230	\$10,766,525	\$12,528,549	\$12,528,549	\$860,319
Fund Balance	\$1,363,548	\$2,819,207	\$2,244,177	\$1,902,282	\$1,902,282	\$(916,925)
Total Source of Funds	\$12,820,956	\$14,487,437	\$13,010,702	\$14,430,831	\$14,430,831	\$(56,606)

Division Description

The Human Resources non-departmental section consists of the Benefit Programs Fund under the management and control of the Human Resources Department. This fund includes separate budget units for Dental, Vision, Employee Assistance Program, Disability, Unemployment, Miscellaneous Benefits, and Other Post-Employment Benefits (OPEB).

The Recommended Budget reflects an increase of \$860,319 in revenues and a decrease of \$56,606 in appropriations compared to the FY 2022-23 Adopted Budget. The increase in revenues is due to an increase in collected dental insurance premiums and miscellaneous benefits departmental allocations. The decrease in appropriations is due to a combination of decreased costs in unemployment insurance claims and OPEB contributions.

Summary of Recommendation

The Recommended Budget for the Human Resources Non-Departmental units is \$14,430,831 in appropriations, financed by \$12,528,549 in revenues and the use of \$1,902,282 in fund balance.

The charges to departments are based on employee utilization and plan design. Over the past years, the Dental, Vision, Employee Assistance Program, Unemployment, and Miscellaneous Benefits sub-funds have accumulated a fund balance surplus; hence the use of fund balance to bring the balance down.

Appropriation Expenditure Detail

	Prior Year 2021-2022	Adopted Budget 2022-2023	CY Estimate 2022-2023	Requested Budget 2023-2024	Recommended Budget 2023-2024	Recommended Change from Adopted	Fund Code	Budget Unit Code
Dental (HRD002)	5,178,819	6,830,301	5,679,276	6,480,067	6,480,067	(350,234)	477	8413
Vision (HRD002)	939,162	1,054,103	912,733	1,156,440	1,156,440	102,337	477	8414
Employee Assistance Program (HRD002)	103,032	106,920	101,574	106,920	106,920	0	477	8415
Disability (HRD002)	397,655	396,946	408,306	463,753	463,753	66,807	477	8416
Unemployment (HRD002)	0	0	0	0	0	0	478	8417
Unemployment (HRD002)	507,322	736,323	471,438	636,362	636,362	(99,961)	477	8417
Misc Benefits (HRD002)	986,920	427,937	513,815	874,163	874,163	446,226	477	8418
Other Post-Employment Benefits (HRD002)	4,708,045	4,934,907	4,923,560	4,713,126	4,713,126	(221,781)	477	8419
Subtotal	\$12,820,956	\$14,487,437	\$13,010,702	\$14,430,831	\$14,430,831	\$(56,606)		

Dental

(Budget Unit 8413—Fund 477—Appropriation Unit HRD002)

Use of Funds

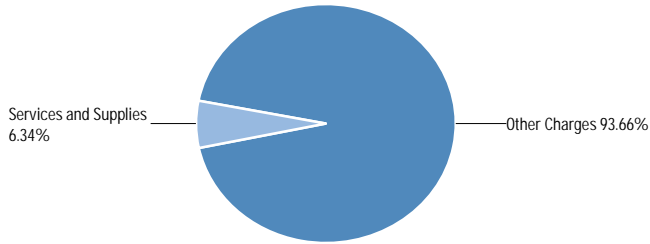

Source of Funds

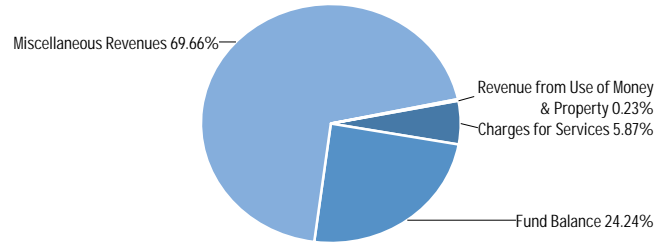

Use of Funds

Expenditures	Prior Year 2021-2022	Adopted Budget 2022-2023	CY Estimate 2022-2023	Requested Budget 2023-2024	Recommended Budget 2023-2024	Recommended Change from Adopted
Services and Supplies	\$244,970	\$771,829	\$780,172	\$411,067	\$411,067	\$(360,762)
Other Charges	\$4,933,849	\$6,058,472	\$4,899,104	\$6,069,000	\$6,069,000	\$10,528
Subtotal	\$5,178,819	\$6,830,301	\$5,679,276	\$6,480,067	\$6,480,067	\$(350,234)

Source of Funds

Revenues	Prior Year 2021-2022	Adopted Budget 2022-2023	CY Estimate 2022-2023	Requested Budget 2023-2024	Recommended Budget 2023-2024	Recommended Change from Adopted
Revenue from Use of Money & Property	\$24,579	\$20,000	\$38,285	\$15,000	\$15,000	\$(5,000)
Charges for Services	\$457,110	\$420,000	\$366,308	\$380,530	\$380,530	\$(39,470)
Miscellaneous Revenues	\$3,584,293	\$3,951,958	\$3,143,657	\$4,513,850	\$4,513,850	\$561,892
Subtotal	\$4,065,982	\$4,391,958	\$3,548,250	\$4,909,380	\$4,909,380	\$517,422
Fund Balance	\$1,112,837	\$2,438,343	\$2,131,026	\$1,570,687	\$1,570,687	\$(867,656)
Total Source of Funds	\$5,178,819	\$6,830,301	\$5,679,276	\$6,480,067	\$6,480,067	\$(350,234)

Unit Description

The Dental Unit is a component of the Benefit Programs Fund that contains revenue and expenditures related to the County's self-insured dental program. Contributions are calculated on a cost recovery basis through premiums charged to County departments and participating employees. Dental insurance premiums may change from year to year due to changes in the cost of utilization claims. An actuarial is

completed on an annual basis by a third party to provide an estimate of projected funding requirements and recommended premium rates.

Whenever there is excess revenue in a specific fiscal year, it is kept in the Benefit Programs Fund to be used in future years when expenditures exceed revenue.

Vision

(Budget Unit 8414—Fund 477—Appropriation Unit HRD002)

Use of Funds

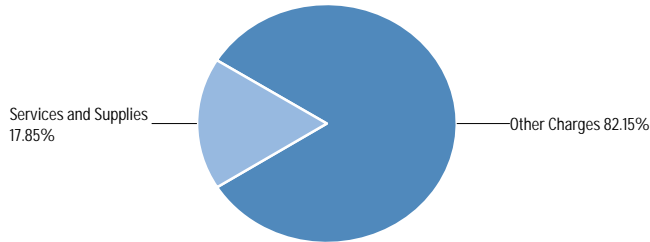

Source of Funds

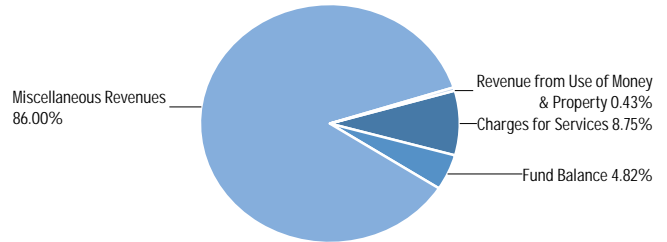

Use of Funds

Expenditures	Prior Year 2021-2022	Adopted Budget 2022-2023	CY Estimate 2022-2023	Requested Budget 2023-2024	Recommended Budget 2023-2024	Recommended Change from Adopted
Services and Supplies	\$90,361	\$93,826	\$88,638	\$206,440	\$206,440	\$112,614
Other Charges	\$848,801	\$960,277	\$824,095	\$950,000	\$950,000	\$(10,277)
Subtotal	\$939,162	\$1,054,103	\$912,733	\$1,156,440	\$1,156,440	\$102,337

Source of Funds

Revenues	Prior Year 2021-2022	Adopted Budget 2022-2023	CY Estimate 2022-2023	Requested Budget 2023-2024	Recommended Budget 2023-2024	Recommended Change from Adopted
Revenue from Use of Money & Property	\$2,987	\$3,000	\$7,351	\$5,000	\$5,000	\$2,000
Charges for Services	\$97,865	\$88,470	\$89,375	\$101,200	\$101,200	\$12,730
Miscellaneous Revenues	\$983,889	\$912,329	\$879,860	\$994,500	\$994,500	\$82,171
Subtotal	\$1,084,741	\$1,003,799	\$976,586	\$1,100,700	\$1,100,700	\$96,901
Fund Balance	\$(145,579)	\$50,304	\$(63,853)	\$55,740	\$55,740	\$5,436
Total Source of Funds	\$939,162	\$1,054,103	\$912,733	\$1,156,440	\$1,156,440	\$102,337

Unit Description

The Vision Unit is a component of the Benefit Programs Fund that contains revenue and expenditures related to the County's self-insured vision program. Contributions are calculated on a cost recovery basis through premiums charged to County departments and participating employees. Vision insurance premiums may change from year to year due to changes in the cost of utilization claims. An actuarial is

completed on an annual basis by a third party to provide an estimate of projected funding requirements and recommended premium rates.

Whenever there is excess revenue in a specific fiscal year, it is kept in the Benefit Programs Fund to be used in future years when expenditures exceed revenue.

Employee Assistance Program

(Budget Unit 8415—Fund 477—Appropriation Unit HRD002)

Use of Funds

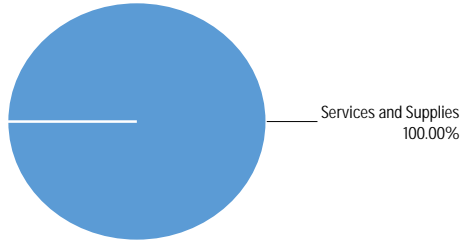

Source of Funds

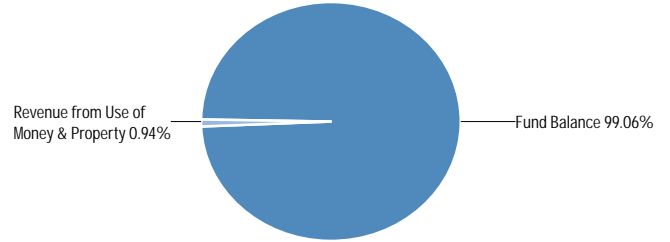

Use of Funds

Expenditures	Prior Year 2021-2022	Adopted Budget 2022-2023	CY Estimate 2022-2023	Requested Budget 2023-2024	Recommended Budget 2023-2024	Recommended Change from Adopted
Services and Supplies	\$103,032	\$106,920	\$101,574	\$106,920	\$106,920	—
Subtotal	\$103,032	\$106,920	\$101,574	\$106,920	\$106,920	—

Source of Funds

Revenues	Prior Year 2021-2022	Adopted Budget 2022-2023	CY Estimate 2022-2023	Requested Budget 2023-2024	Recommended Budget 2023-2024	Recommended Change from Adopted
Revenue from Use of Money & Property	\$1,543	\$1,500	\$3,466	\$1,000	\$1,000	\$(500)
Miscellaneous Revenues	\$110,635	\$53,460	\$9,467	—	—	\$(53,460)
Subtotal	\$112,178	\$54,960	\$12,933	\$1,000	\$1,000	\$(53,960)
Fund Balance	\$(9,146)	\$51,960	\$88,641	\$105,920	\$105,920	\$53,960
Total Source of Funds	\$103,032	\$106,920	\$101,574	\$106,920	\$106,920	—

Unit Description

The Employee Assistance Program (EAP) Unit is a component of the Benefit Programs Fund that contains revenue and expenditures related to the County's Employee Assistance Program. Contributions are calculated on a cost recovery basis through charges allocated to County departments based on a flat fee per employee. A given

department's allocation may change from year to year due to any changes in number of employees and cost of benefits.

Whenever there is excess revenue in a specific fiscal year, it is kept in the Benefit Programs Fund to be used in future years when expenditures exceed revenue.

Disability

(Budget Unit 8416—Fund 477—Appropriation Unit HRD002)

Use of Funds

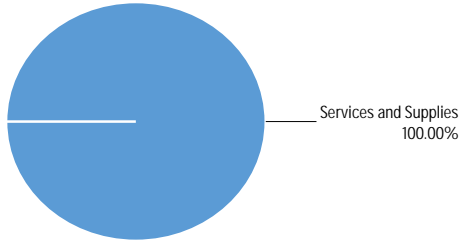

Source of Funds

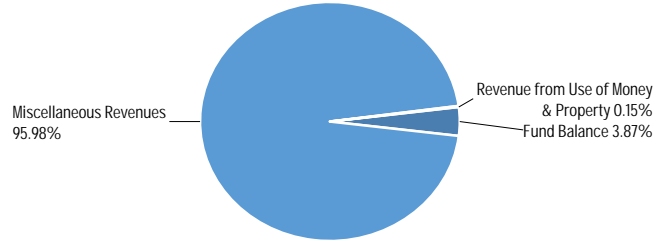

Use of Funds

Expenditures	Prior Year 2021-2022	Adopted Budget 2022-2023	CY Estimate 2022-2023	Requested Budget 2023-2024	Recommended Budget 2023-2024	Recommended Change from Adopted
Salaries and Employee Benefits	\$397,655	—	\$408,306	—	—	—
Services and Supplies	—	\$396,946	—	\$463,753	\$463,753	\$66,807
Subtotal	\$397,655	\$396,946	\$408,306	\$463,753	\$463,753	\$66,807

Source of Funds

Revenues	Prior Year 2021-2022	Adopted Budget 2022-2023	CY Estimate 2022-2023	Requested Budget 2023-2024	Recommended Budget 2023-2024	Recommended Change from Adopted
Revenue from Use of Money & Property	\$389	\$400	\$870	\$700	\$700	\$300
Charges for Services	\$183	\$250	\$53	\$100	\$100	\$(150)
Miscellaneous Revenues	\$387,043	\$396,696	\$402,732	\$445,000	\$445,000	\$48,304
Subtotal	\$387,615	\$397,346	\$403,655	\$445,800	\$445,800	\$48,454
Fund Balance	\$10,040	\$(400)	\$4,651	\$17,953	\$17,953	\$18,353
Total Source of Funds	\$397,655	\$396,946	\$408,306	\$463,753	\$463,753	\$66,807

Unit Description

The Disability Unit is a component of the Benefit Programs Fund that contains revenue and expenditures related to the County's disability (long-term and short-term) program. Contributions are calculated on a cost recovery basis through charges allocated to County departments based on a flat fee per eligible employee. A given department's

allocation may change from year to year due to any changes in number of eligible employees and cost of benefits.

Whenever there is excess revenue in a specific fiscal year, it is kept in the Benefit Programs Fund to be used in future years when expenditures exceed revenue.

Unemployment

(Budget Unit 8417—Fund 477—Appropriation Unit HRD002)

Use of Funds

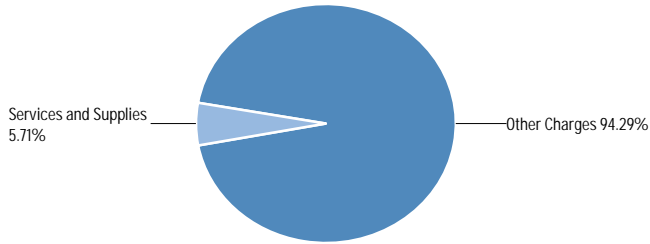

Source of Funds

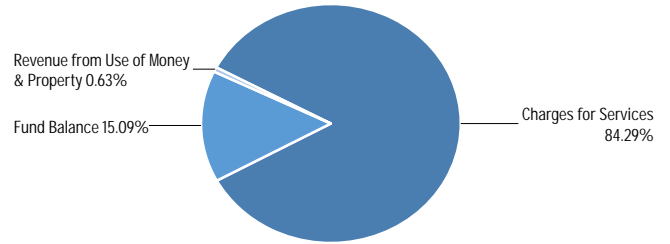

Use of Funds

Expenditures	Prior Year 2021-2022	Adopted Budget 2022-2023	CY Estimate 2022-2023	Requested Budget 2023-2024	Recommended Budget 2023-2024	Recommended Change from Adopted
Services and Supplies	\$35,722	\$36,323	\$35,809	\$36,362	\$36,362	\$39
Other Charges	\$471,600	\$700,000	\$435,629	\$600,000	\$600,000	\$(100,000)
Subtotal	\$507,322	\$736,323	\$471,438	\$636,362	\$636,362	\$(99,961)

Source of Funds

Revenues	Prior Year 2021-2022	Adopted Budget 2022-2023	CY Estimate 2022-2023	Requested Budget 2023-2024	Recommended Budget 2023-2024	Recommended Change from Adopted
Revenue from Use of Money & Property	\$2,249	\$2,000	\$4,542	\$4,000	\$4,000	\$2,000
Charges for Services	\$470,642	\$486,323	\$486,323	\$536,362	\$536,362	\$50,039
Subtotal	\$472,891	\$488,323	\$490,865	\$540,362	\$540,362	\$52,039
Fund Balance	\$34,431	\$248,000	\$(19,427)	\$96,000	\$96,000	\$(152,000)
Total Source of Funds	\$507,322	\$736,323	\$471,438	\$636,362	\$636,362	\$(99,961)

Unit Description

The Unemployment Unit is a component of the Benefit Programs Fund that contains revenue and expenditures related to the County's self-insured unemployment program. Contributions are calculated on a cost recovery basis through charges allocated to County departments based on employee count. A given department's

allocation may change from year to year due to any changes in number of employees and cost of benefits.

Whenever there is excess revenue in a specific fiscal year, it is kept in the Benefit Programs Fund to be used in future years when expenditures exceed revenue.

Misc Benefits

(Budget Unit 8418—Fund 477—Appropriation Unit HRD002)

Use of Funds

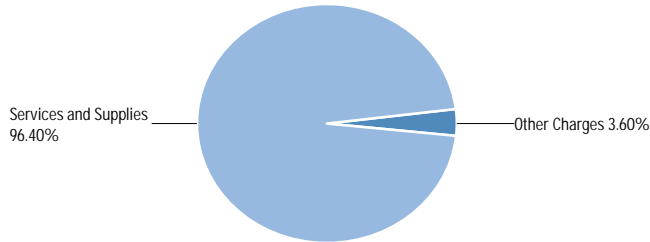

Source of Funds

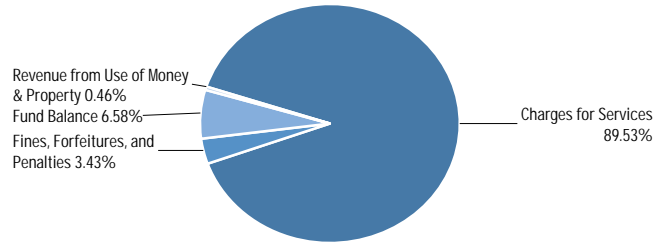

Use of Funds

Expenditures	Prior Year 2021-2022	Adopted Budget 2022-2023	CY Estimate 2022-2023	Requested Budget 2023-2024	Recommended Budget 2023-2024	Recommended Change from Adopted
Services and Supplies	\$953,532	\$427,937	\$513,815	\$842,680	\$842,680	\$414,743
Other Charges	\$33,388	—	—	\$31,483	\$31,483	\$31,483
Subtotal	\$986,920	\$427,937	\$513,815	\$874,163	\$874,163	\$446,226

Source of Funds

Revenues	Prior Year 2021-2022	Adopted Budget 2022-2023	CY Estimate 2022-2023	Requested Budget 2023-2024	Recommended Budget 2023-2024	Recommended Change from Adopted
Fines, Forfeitures, and Penalties	\$46,836	\$30,000	\$30,000	\$30,000	\$30,000	—
Revenue from Use of Money & Property	\$3,353	\$3,000	\$4,712	\$4,000	\$4,000	\$1,000
Charges for Services	\$585,787	\$362,937	\$362,937	\$782,681	\$782,681	\$419,744
Subtotal	\$635,976	\$395,937	\$397,649	\$816,681	\$816,681	\$420,744
Fund Balance	\$350,944	\$32,000	\$116,166	\$57,482	\$57,482	\$25,482
Total Source of Funds	\$986,920	\$427,937	\$513,815	\$874,163	\$874,163	\$446,226

Unit Description

The Miscellaneous Benefits Unit is a component of the Benefit Programs Fund that contains revenue and expenses related to other miscellaneous benefit programs such as the Flexible Spending Account, Dependent Care Assistance Program, Voluntary Benefit Options, and health insurance administration fees. Contributions are calculated on a cost recovery basis through charges allocated to

County departments based on employee count. A given department's allocation may change from year to year due to changes in number of employees and cost of benefits administration.

Whenever there is excess revenue in a specific fiscal year, it is kept in the Benefit Programs Fund to be used in future years when expenditures exceed revenue.

Other Post-Employment Benefits

(Budget Unit 8419—Fund 477—Appropriation Unit HRD002)

Use of Funds

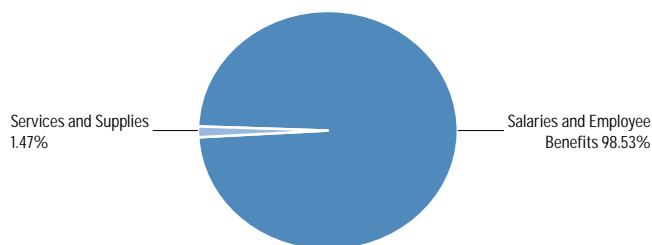

Source of Funds

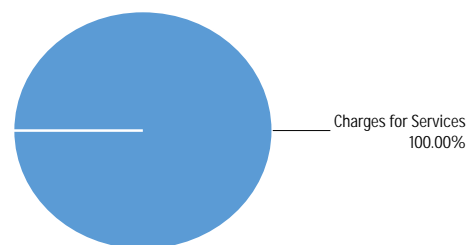

Use of Funds

Expenditures	Prior Year 2021-2022	Adopted Budget 2022-2023	CY Estimate 2022-2023	Requested Budget 2023-2024	Recommended Budget 2023-2024	Recommended Change from Adopted
Salaries and Employee Benefits	\$4,652,760	\$4,876,000	\$4,884,700	\$4,644,000	\$4,644,000	\$(232,000)
Services and Supplies	\$55,285	\$58,907	\$38,860	\$69,126	\$69,126	\$10,219
Subtotal	\$4,708,045	\$4,934,907	\$4,923,560	\$4,713,126	\$4,713,126	\$(221,781)

Source of Funds

Revenues	Prior Year 2021-2022	Adopted Budget 2022-2023	CY Estimate 2022-2023	Requested Budget 2023-2024	Recommended Budget 2023-2024	Recommended Change from Adopted
Revenue from Use of Money & Property	\$4,574	\$1,000	\$1,680	\$1,500	\$1,500	\$500
Charges for Services	\$4,693,450	\$4,934,907	\$4,934,907	\$4,713,126	\$4,713,126	\$(221,781)
Subtotal	\$4,698,024	\$4,935,907	\$4,936,587	\$4,714,626	\$4,714,626	\$(221,281)
Fund Balance	\$10,021	\$(1,000)	\$(13,027)	\$(1,500)	\$(1,500)	\$(500)
Total Source of Funds	\$4,708,045	\$4,934,907	\$4,923,560	\$4,713,126	\$4,713,126	\$(221,781)

Unit Description

The Other Post-Employment Benefits (OPEB) Unit is a component of the Benefit Programs Fund that contains revenue and expenses related to OPEB. The County's OPEB are limited to the State mandated amount that the County pays for retirees' health care, including payments for current retirees and Board of Supervisors' authorized pre-funding of benefit costs for future retirees. Biennial actuarial analyses are performed which determine the County's annual

contributions. Contributions are charged to County departments based on employee count and transmitted to the California Employers' Retirement Benefit Trust for investment purposes.

Whenever there is excess revenue in a specific fiscal year, it is contributed to the California Employers' Retirement Benefit Trust as an additional contribution.



This page intentionally left blank.

Civil Rights Office

Department Overview:

The Civil Rights Office (CRO) helps the County respect civil rights, provide equal opportunity for all, and pursue equity in all operations. Through training, the department strives to develop a culture that treats everyone that interacts with or works at the County equally and with respect. The CRO advises County departments on diversity, equity, and inclusion, and enforces Titles VI and VII of the Civil Rights Act of 1964, the Americans with Disabilities Act of 1990, the California Fair Employment and Housing Act, the County of Monterey nondiscrimination ordinances (Chapters 2.19 and 2.80 of the Monterey County Code), related policies (Nondiscrimination, Sexual Harassment, Language Access and Effective Communication, and Reasonable Accommodation), and the County of Monterey Equal Opportunity (EOP) and Title VI Plans.

Programs and Functions:

The Civil Rights Office develops and provides two mandatory trainings: the California-mandated Harassment and Discrimination Prevention (HDP) training and the Civil Rights training (CRT). The Office advises departments on applying equal opportunity law, developing and using equitable tools to support fair recruitment efforts, community engagement, and workplace diversity, equity, and inclusion practices in their operations. The Office also reviews and resolves complaints of unlawful discrimination, harassment, and retaliation, in violation of federal and California civil rights statutes.

In addition to internally handling equity, diversity, and inclusion issues, the Civil Rights Office also reviews the same problems related to Monterey County residents, as established by Title VI of the Civil Rights Act of 1964. In that role, the Civil Rights Office acts as a conduit to help residents address discrimination when interacting with the County and ensure equitable and fair access to services.

Department's Contribution to Monterey County's Strategic Initiatives:

ADMINISTRATION: Administers the County's Equal Opportunity Plan and Title VI Implementation Plan. Implements mandatory HDP and CRT training. Handles unlawful discrimination, harassment, and retaliation complaints.

HEALTH AND HUMAN SERVICES: Provides training that seeks to improve and maintain work satisfaction at a high level by creating a more respectful and inclusive workplace culture free from harassment, discrimination, and abusive conduct. Helps participants understand and gain tools to address implicit bias and inequities at individual and institutional levels, understand cultural competence, and strive for cultural humility.

INFRASTRUCTURE: Supports departments tasked with planning and developing physical infrastructure by focusing on fairness and equitable access to infrastructure. The CRO aids departments in complying with the Americans with Disabilities Act, ensuring County buildings and services are accessible to people with disabilities thereby providing equitable access to County services, according to Title VI of the Civil Rights Act of 1964.

PUBLIC SAFETY: Supports the County's public safety branches in achieving their goals while interacting with the public to create a safe environment for people to fulfill their potential, allowing businesses and communities to thrive and grow.



train



advise



enforce



Operating Budget: \$407,997
Positions (FTEs): 5.00

Juan P. Rodriguez
Civil Rights Officer

Civil Rights Office

Staffing Trends

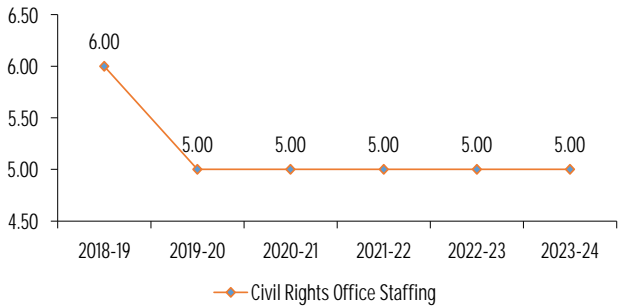

Expenditure/Revenue History (in millions)

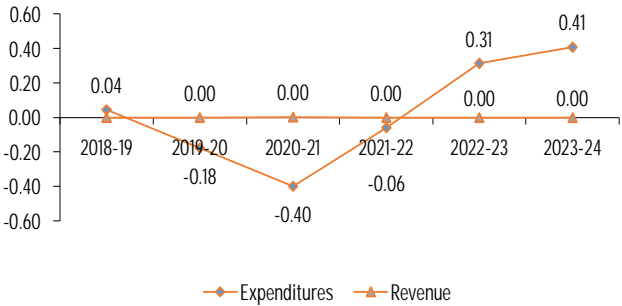

The Civil Rights Office helps the County respect civil rights, provide equal opportunity for all, and pursue equity in all operations by developing culture of diversity and inclusion.

Key Performance Measures	2020-21 Actual	2021-22 Actual	2022-23 Mid-Year
Percent of County non-management employees completing the Harassment and Discrimination Prevention training requirement. Target = 75%	92%	76%	83%
Percent of County management employees completing the Harassment and Discrimination Prevention training requirement. Target = 75%	92%	81%	85%
Percent of County non-management employees completing the Civil Rights training requirement. Target = 50%	73%	41%	82%
Percent of County management employees completing the Civil Rights training requirement. Target = 75%	36%	48%	80%
Percent of inquiries and complaints of discrimination submitted to the Civil Rights Office processed within 90 days. Target = 75%	91%	93%	91%

Use of Funds

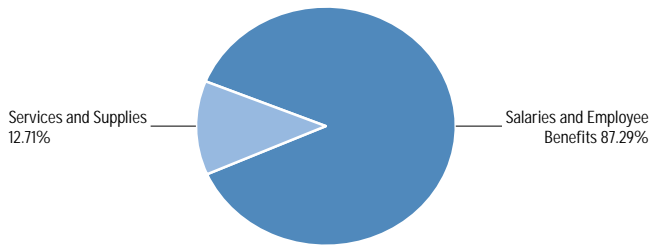

Source of Funds

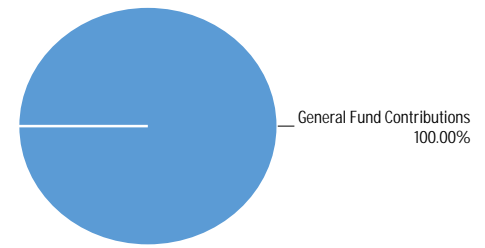

Use of Funds

Expenditures	Prior Year 2021-2022	Adopted Budget 2022-2023	CY Estimate 2022-2023	Requested Budget 2023-2024	Recommended Budget 2023-2024	Recommended Change from Adopted
Salaries and Employee Benefits	\$710,139	\$952,126	\$889,824	\$990,058	\$990,058	\$37,932
Services and Supplies	\$119,606	\$147,889	\$142,074	\$158,141	\$144,141	\$(3,748)
Other Charges	\$(889,746)	\$(718,754)	\$(718,754)	\$(726,202)	\$(726,202)	\$(7,448)
Subtotal	\$(60,001)	\$381,261	\$313,144	\$421,997	\$407,997	\$26,736

Source of Funds

Revenues	Prior Year 2021-2022	Adopted Budget 2022-2023	CY Estimate 2022-2023	Requested Budget 2023-2024	Recommended Budget 2023-2024	Recommended Change from Adopted
General Fund Contributions	\$(60,001)	\$381,261	\$313,144	\$421,997	\$407,997	\$26,736
Total Source of Funds	\$(60,001)	\$381,261	\$313,144	\$421,997	\$407,997	\$26,736

Summary of Recommendation

The FY 2023-24 Recommended Budget for the Civil Rights Office includes a General Fund Contribution (GFC) of \$407,997 and a \$726,202 Countywide Cost Allocation Plan credit to support the department's costs of \$1,134,199. This is a GFC increase of \$26,736 from the current year Adopted Budget due to increased salary and benefit costs.

Budget Impacts

The Civil Rights Office received two of three augmentation requests, including \$22,294 to fund State-mandated online Harassment and Discrimination Prevention training and an electronic case management system for Civil Rights Office complaints and \$16,000 for Equal Opportunity Plan development, implementation, and support. An augmentation request in the amount of \$14,000 to fund American Sign Language Interpretation and Document Translation services was not recommended. The Civil Rights Office will continue to work with other County departments and sister agencies to identify shared resources to lessen budget impacts.

Prior Year Accomplishments

The department hired a Senior Equal Opportunity Analyst to lead the County's Governing for Racial Equity (GRE) initiatives and Racial Equity Action Plan, which advances the Board of Supervisor's efforts to promote diversity, equity, and inclusion in Monterey County. The Civil Rights Office has established monthly meetings with County departments and subject matter experts to develop and implement

GRE goals for the current and upcoming years. The Civil Rights Office debuted a Budget Equity Tool prototype to help departments examine whether budgetary decisions align with advancing the County's commitments to equity and inclusion. The CRO updated the County's Title VI Plan, revised its policies to expand inclusive language, and updated requirements to Title VI initiatives.

The CRO coordinated and facilitated several public workshops in the community to discuss the need for an LGBTQ+ Commission in Monterey. By soliciting and listening to community input, the County learned about some of the needs of the local LGBTQ+ community to provide more responsive services.

The Office relaunched its quarterly newsletters to educate County employees on civil rights and CRO services and projects and introduced monthly office hours where employees meet CRO staff to ask questions about civil rights related issues and best practices.

The CRO continues to work with County employees to promote awareness around Employee Resource Groups (ERGs), also known as affinity groups. After launching ERG services and chartering its first LGBTQ+ ERG (LGBTQ+ Professionals) in FY 2021-2022, the department has also supported the formation of the Monterey County Veteran ERG and Neurodiverse Employee ERG in FY 2022-2023.

The CRO continues its partnership with the County's Probation Department to provide youth in Juvenile Hall and the Youth Center training in civil rights, diversity, equity, and inclusion. These sessions are well received by attendees and Probation Department staff. In addition, the CRO is working with local cities, non-profits, agencies, and other quasi- and non-governmental organizations to facilitate

trainings that align with the County’s goal to promote diversity, equity, and inclusion efforts in the community.

As required by California Government Code Sections 12950.1, employers must train all County employees every two years on preventing harassment and discrimination. The Civil Rights Office helped the County exceed its training compliance goal of 75% by fifteen points. Currently, the County has an overall compliance rate of 90% for all County employees.

Budget Year Goals

Implement an internal Title VI auditing system to ensure departments comply with Title VI requirements.

Institutionalize Governing for Racial Equity (GRE) initiatives to embed them in all County operations.

Partner with community groups dedicated to social action and learning.

Offer a robust training and webinar menu that expands local GRE efforts and Employee Resource Group recognition and opportunities.

Continue to assist the Equal Opportunity and Civil Rights Advisory Commission in monitoring annual departmental Equal Opportunity Plans.

Continue to provide Harassment and Discrimination Prevention (HDP) training and Civil Rights Training (CRT) countywide and implement a structure where departments can stay on track of their compliance throughout the year.

Continue to provide Civil Rights Training to community partners, such as government agencies, non-profits, and other non-governmental organizations.

Continue to provide customized training to departments on cultural competency, cultural humility, and equity issues.

Continue providing timely, unbiased, informed support and investigations to employees and the public.

Continue to provide conflict resolution alternatives outside of the complaint process, as allowed by federal and California laws and County ordinances and policies.

Pending Issues

There are no pending issues.

Policy Considerations

As of January 2021, Government Code Sections 12950 and 12950.1 now require that California employers, including the County, provide harassment and discrimination prevention training to all employees, not just supervisors and managers, every two years. This mandate increased our training requirement significantly.

The 2020 election saw the defeat of Proposition 16. This proposition would have repealed Proposition 209 Affirmative Action Amendment passed in 1996, which prohibits affirmative action policies in employment in California. While this might make it more difficult for the County to reach its diversity, equity, and inclusion goals, it provides the Civil Rights Office with the opportunity to find creative solutions and work collaboratively with other County Departments, sister agencies, and other non-governmental organizations to meet these goals.

Appropriation Expenditure Detail

	Prior Year 2021-2022	Adopted Budget 2022-2023	CY Estimate 2022-2023	Requested Budget 2023-2024	Recommended Budget 2023-2024	Recommended Change from Adopted	Fund Code	Budget Unit Code
Civil Rights Office (CRO001)	(60,001)	381,261	313,144	421,997	407,997	26,736	001	8505
Subtotal	\$(60,001)	\$381,261	\$313,144	\$421,997	\$407,997	\$26,736		

Budget Units

	Prior Year 2021-2022	Adopted Budget 2022-2023	CY Estimate 2022-2023	Requested Budget 2023-2024	Recommended Budget 2023-2024	Recommended Change from Adopted
Civil Rights Office	\$(60,001)	\$381,261	\$313,144	\$421,997	407,997	\$26,736
Subtotal	\$(60,001)	\$381,261	\$313,144	\$421,997	\$407,997	\$26,736

Adopted FY 2022-23 to Recommended FY 2023-24 Positions

Classification Code	Classification Label	Adopted Budget 2021-2022	Adopted Budget 2022-2023	Recommended Budget 2023-2024	Change
14B25	EQUAL OPPORTUNITY OFFICER	1.00	1.00	1.00	0.00
14B47	ASSOCIATE EQUAL OPPORTUNITY ANALYST	2.00	1.00	1.00	0.00
14B49	SENIOR EQUAL OPPORTUNITY ANALYST	1.00	2.00	2.00	0.00
80A99	ADMINISTRATIVE SECRETARY-CONFIDENTIAL	1.00	1.00	1.00	0.00
	Total	5.00	5.00	5.00	0.00

Augmentation Requests

Request Code	Request Name	Ranking Type Name	Requested Amount	Requested FTE	Recommended Budget	Recommended FTE
1080-8505-001-AUG1	Mandated Training and Case Management	Status Quo Other	22,294	-	22,294	-
1080-8505-001-AUG2	Equal Opportunity Plan Performance	Status Quo Other	16,000	-	16,000	-
1080-8505-001-AUG3	ASL and Document Translation	Status Quo Other	14,000	-	-	-
Grand Total:			\$52,294	-	\$38,294	-



This page intentionally left blank.

Auditor-Controller

Departmental Overview:

The Office of the Auditor-Controller is an elected office in the Executive Branch of the County of Monterey Government. The mandated duties of the position are performed under legal authority set forth in the California Government Code, the Revenue and Taxation Code, and the County of Monterey Code, and in accordance with uniform Generally Accepted Accounting Principles (GAAP) and other authoritative bodies on a State and National level. The Auditor-Controller is the County's Chief Accounting Officer and exercises general supervision over accounting forms and methods of organization for County departments and districts under the control of the Board of Supervisors and, districts whose funds are maintained in the County Treasury.

Other responsibilities include disbursement of County funds in Treasury, budgetary control, debt payment administration, compilation and publication of the County's financial statements, cost allocation plan, maintenance of tax rolls, tax rate calculations, apportionment of property tax, payroll preparation, disbursement and maintenance of financial records, and payment of all claims against the County. The Board of Supervisors may assign additional responsibilities.

Programs and Functions:

The Office of the Auditor-Controller consists of five divisions: Auditor-Controller (Administration), Disbursements, General Accounting, Internal Audit, and Systems Management.

The Administration Division is responsible for strategic planning, policy guidance and facilitating office environments. The Disbursements Division oversees Accounts Payable, Payroll and Property Tax. The General Accounting Division provides support and financial oversight via the County's official system of record, adhering to policies, procedures, and processes in accordance with GAAP, County policies and State and Federal guidelines. The Internal Audit Division is responsible for executing audit programs for County departments, special districts, and other agencies. The Systems Management Division maintains the official financial system record for the County.

In addition, the Auditor-Controller performs (non-departmental) functions such as Public Improvement Corporation (PIC) Debt Service; management of consultant service contracts that monitor County's sales tax revenue; preparing reimbursement claims for cost of County's programs mandated by the State; and annual audits.

Department's Contributions to County of Monterey's Strategic Initiatives:

ADMINISTRATION

The Office of the Auditor-Controller promotes an organization that practices efficient and effective resource management and is recognized for responsiveness, strong customer orientation, accountability and transparency which includes budget control and control over the official system of record. This commitment is reflected in this Office's Strategic Plan and the Government Finance Officers Association (GFOA) award winning Annual Comprehensive Financial Report (ACFR).

Auditor-Controller

Serving
Monterey
County



Property Tax Calculations & Disbursements



Payroll & Accounts Payable



Accounting Services



Audit Services



Debt Services



Auditor-Controller

Operating Budget: \$17,779,954
Positions (FTEs): 56.50

Rupa Shah
Auditor-Controller

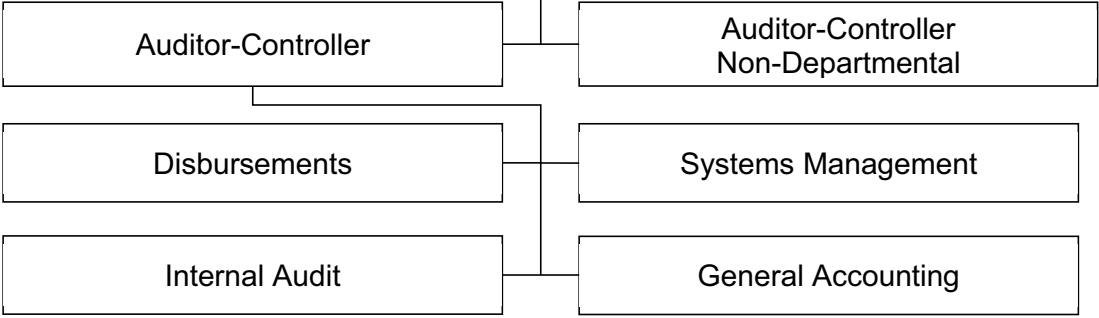

Staffing Trends

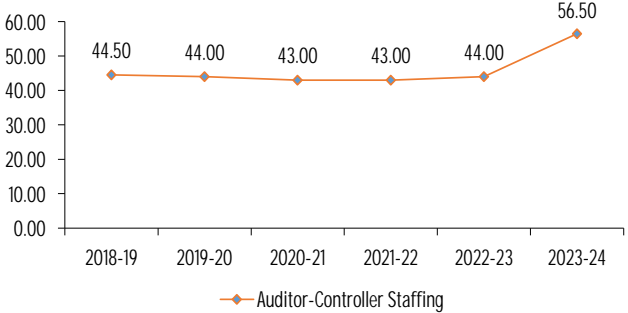

Expenditure/Revenue History (in millions)

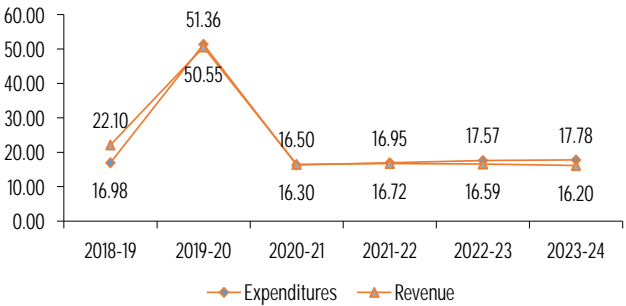

The Office of the Auditor-Controller performs local, State and federally mandated duties, promotes an organization that practices efficient and effective resource management, and is recognized for accountability and transparency.

Key Performance Measures	2020-21 Actual	2021-22 Actual	2022-23 Mid-Year
Number of claims paid by electronic payments. Target = 884	1,561	1,659	810
Percentage of Direct Deposits to banks. Target = 100%.	95%	95%	95%
Standardize pay practices. Target = reduce the number of pay, leave, deduction and benefit events based on MOU.	100,271	98,276	99,702

Use of Funds

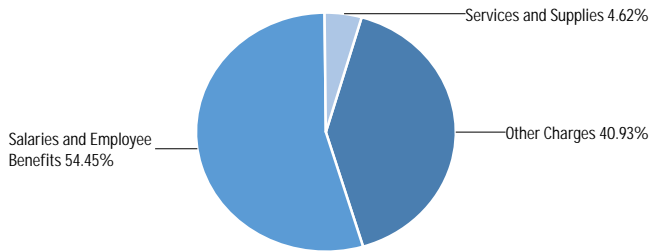

Source of Funds

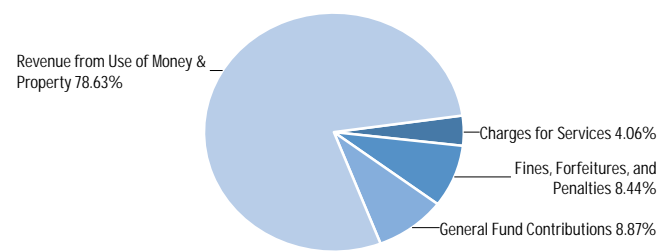

Use of Funds

Expenditures	Prior Year 2021-2022	Adopted Budget 2022-2023	CY Estimate 2022-2023	Requested Budget 2023-2024	Recommended Budget 2023-2024	Recommended Change from Adopted
Salaries and Employee Benefits	\$5,883,622	\$7,144,140	\$6,710,730	\$10,229,732	\$9,681,507	\$2,537,367
Services and Supplies	\$537,616	\$569,679	\$687,683	\$820,934	\$820,934	\$251,255
Other Charges	\$10,490,903	\$10,172,375	\$10,172,375	\$7,277,513	\$7,277,513	\$(2,894,862)
Capital Assets	\$33,544	—	—	—	—	—
Subtotal	\$16,945,684	\$17,886,194	\$17,570,788	\$18,328,179	\$17,779,954	\$(106,240)

Source of Funds

Revenues	Prior Year 2021-2022	Adopted Budget 2022-2023	CY Estimate 2022-2023	Requested Budget 2023-2024	Recommended Budget 2023-2024	Recommended Change from Adopted
Fines, Forfeitures, and Penalties	—	\$1,500,000	\$1,500,000	\$1,500,000	\$1,500,000	—
Revenue from Use of Money & Property	\$5,927,070	\$14,478,525	\$14,478,525	\$13,980,525	\$13,980,525	\$(498,000)
Charges for Services	\$732,737	\$593,371	\$607,845	\$722,060	\$722,060	\$128,689
Miscellaneous Revenues	\$30	—	—	—	—	—
Other Financing Sources	\$10,061,799	—	—	—	—	—
Subtotal	\$16,721,636	\$16,571,896	\$16,586,370	\$16,202,585	\$16,202,585	\$(369,311)
Fund Balance	\$1,481	—	—	—	—	—
General Fund Contributions	\$222,567	\$1,314,298	\$984,418	\$2,125,594	\$1,577,369	\$263,071
Total Source of Funds	\$16,945,684	\$17,886,194	\$17,570,788	\$18,328,179	\$17,779,954	\$(106,240)

Summary of Recommendation

The Fiscal Year (FY) 2023-24 Recommended Budget for the Office of the Auditor-Controller is \$17,779,954 in appropriations with total expenditures of \$25,963,966, financed by \$16,202,585 in revenue, \$5,866,525 cost plan credits, \$2,317,487 in interfund reimbursements, and a general fund contribution (GFC) of \$1,577,369. Expenditures decreased by \$106,240 mainly due to decreased bond related expenditures offset by increases in negotiated salary and employee health insurance costs.

Budget Impacts

The Recommended Budget includes augmentations for 12 new positions for the implementation of the new Enterprise Resource Planning (ERP) replacement project. The positions will support the Systems Management Division operations while existing staff is deployed to the project implementation. The positions will be funded by interfund reimbursements from the Fund 478 - Enterprise Resource Planning.

Prior Year Accomplishments

Sent regular email communication to timekeepers with procedures, negotiated changes or videos.

All special assessments were loaded and balanced, tax rates approved by the Board of Supervisors, and all FY 2022-23 tax information updated in Megabyte.

Secured extension was successfully run mid-September and secured property tax bills were created.

The FY 2022-23 Tax Rate Book was prepared and published on the Auditor-Controller's website in October 2022.

Property tax apportionments were successfully calculated and distributed on December 21, 2022.

The Annual Comprehensive Financial Report (ACFR) for FY 2021-22 was posted to the Auditor-Controller's website on April 7, 2023.

Applied for the Award for Excellence in Financial Reporting from Government Finance Officers Association (GFOA).

Received the GFOA Award for Excellence in Financial Reporting for the FY 2020-21 ACFR.

Assisted with the FY 2021-22 Annual Audit and the Single Audit conducted by the independent auditing firm. Annual Audit and Single Audit were issued by March 31, 2023.

Prepared and submitted the State Financial Transactions report for the County and Special Districts for FY 2021-22 by January 31, 2023.

Prepared and submitted the Countywide Cost Allocation Plan for use in FY 2023-24 by January 31, 2023.

Adopted Budget book published December 12, 2022.

Collaborated with benefits to restructure benefit policy codes to accommodate various cash-out options within bargaining units.

Budget Year Goals

Meet with department timekeepers, finance managers and benefit coordinators via Zoom to disseminate information regarding Memorandum of Understanding (MOU) and Fair Labor Standards Act (FLSA) changes and continue training on Monterey County Travel and Business Expense Reimbursement Policy. Recorded Zoom meetings will be posted for reference and training.

Update and distribute Accounts Payable Training Manual to countywide finance staff.

Updated training documents will be posted for reference and training.

By September 2023, have all special assessments loaded and balanced, tax rates approved by the Board of Supervisors, and FY 2023-24 information updated in property tax system to run the secured extension process for creating the secured property tax roll.

By December 31, 2023, calculate FY 2023-24 apportionment factors and compile information to complete the Tax Rate Book for FY 2023-24 and publish on Auditor-Controller's website.

Prepare the Annual Comprehensive Financial Report (ACFR) for FY 2022-23 and receive an unmodified opinion by December 31, 2023.

Apply for and receive the Award for Excellence in Financial Reporting from GFOA.

By December 31, 2023, assist with completion of the FY 2022-23 Annual Audit for the ACFR and compile the Schedule of Expenditures of Federal Awards (SEFA) for use by the external auditors for the Single Audit.

Prepare the State Financial Transactions report for the County and Special Districts for FY 2023-24 by January 31, 2024.

Prepare the Countywide Cost Allocation Plan for use in FY 2024-25, by December 31, 2023.

Prepare the FY 2023-24 Adopted Budget book by December 1, 2023 and publish on the Auditor-Controller's website by December 31, 2023.

Prepare for the ERP Systems replacement project, such as systems readiness, resource allocation, requirement matching, and implementation services.

Develop and facilitate Advantage HRM Security and Accounting Override Management training to departments, incorporating the requirements for the new ERP system.

Continue to provide coordination for Fiscal Year end roll over process for Human Resources Information System (HRIS).

Pending Issues

Pending completion of the State Controller's review and approval of the preliminary Countywide Cost Allocation Plan in June 2023, the adopted budget may be impacted.

Policy Considerations

There are no policy considerations.

Appropriation Expenditure Detail

	Prior Year 2021-2022	Adopted Budget 2022-2023	CY Estimate 2022-2023	Requested Budget 2023-2024	Recommended Budget 2023-2024	Recommended Change from Adopted	Fund Code	Budget Unit Code
PIC Debt Service (AUD005)	15,990,350	15,978,525	15,978,525	15,480,525	15,480,525	(498,000)	251	8007
Annual Audits (AUD002)	(6,830)	118,885	118,885	216,380	216,380	97,495	001	8010
Auditor Controller (AUD001)	(4,390,245)	(4,651,511)	(4,597,895)	(4,655,541)	(4,655,541)	(4,030)	001	8011
Debt Management (AUD001)	1,752	0	0	0	0	0	001	8371
Disbursements (AUD001)	2,549,748	2,860,045	2,738,394	3,231,685	3,123,779	263,734	001	8372
Systems Management (AUD001)	870,964	1,327,655	1,079,348	1,258,262	1,258,262	(69,393)	001	8373
General Accounting (AUD001)	1,644,807	1,879,463	1,907,674	2,092,875	1,955,620	76,157	001	8374
Internal Audit (AUD001)	285,139	373,132	345,857	703,993	400,929	27,797	001	8375
Subtotal	\$16,945,684	\$17,886,194	\$17,570,788	\$18,328,179	\$17,779,954	\$(106,240)		

Budget Units

	Prior Year 2021-2022	Adopted Budget 2022-2023	CY Estimate 2022-2023	Requested Budget 2023-2024	Recommended Budget 2023-2024	Recommended Change from Adopted
PIC Debt Service	\$15,990,350	\$15,978,525	\$15,978,525	\$15,480,525	15,480,525	\$(498,000)
Annual Audits	\$(6,830)	\$118,885	\$118,885	\$216,380	216,380	\$97,495
Auditor Controller	\$(4,390,245)	\$(4,651,511)	\$(4,597,895)	\$(4,655,541)	(4,655,541)	\$(4,030)
Debt Management	\$1,752	—	—	—	—	—
Disbursements	\$2,549,748	\$2,860,045	\$2,738,394	\$3,231,685	3,123,779	\$263,734
Systems Management	\$870,964	\$1,327,655	\$1,079,348	\$1,258,262	1,258,262	\$(69,393)
General Accounting	\$1,644,807	\$1,879,463	\$1,907,674	\$2,092,875	1,955,620	\$76,157
Internal Audit	\$285,139	\$373,132	\$345,857	\$703,993	400,929	\$27,797
Subtotal	\$16,945,684	\$17,886,194	\$17,570,788	\$18,328,179	\$17,779,954	\$(106,240)

Adopted FY 2022-23 to Recommended FY 2023-24 Positions

Classification Code	Classification Label	Adopted Budget 2021-2022	Adopted Budget 2022-2023	Recommended Budget 2023-2024	Change
10B02	AUDITOR-CONTROLLER	1.00	1.00	1.00	0.00
12A02	ASSISTANT AUDITOR-CONTROLLER	1.00	1.00	1.00	0.00
14B32	SENIOR PERSONNEL ANALYST	0.00	0.00	0.50	0.50
14C71	ADMINISTRATIVE SERVICES OFFICER	1.00	1.00	1.00	0.00
14P32	ERP BUSINESS ANALYST	5.00	5.00	8.00	3.00
16F41	DEPARTMENTAL INFORMATION SYSTEMS MANAGER II	0.00	1.00	1.00	0.00
20B21	ACCOUNTANT AUDITOR II	1.00	1.00	2.00	1.00
20B22	ACCOUNTANT AUDITOR III	6.00	7.00	9.00	2.00
20B24	AUDITOR-CONTROLLER ANALYST I	6.00	6.00	8.00	2.00
20B25	AUDITOR-CONTROLLER ANALYST II	2.00	2.00	5.00	3.00
20B31	INTERNAL AUDITOR II	1.00	1.00	1.00	0.00
20B97	CHIEF DEPUTY AUDITOR-CONTROLLER	3.00	3.00	4.00	1.00
80J21	ACCOUNT CLERK	1.00	1.00	1.00	0.00
80J22	SENIOR ACCOUNT CLERK	3.00	0.00	0.00	0.00
80J30	ACCOUNTING TECHNICIAN	2.00	5.00	5.00	0.00
80J80	ACCOUNTS PAYABLE SUPERVISOR	1.00	0.00	0.00	0.00
80J96	PAYROLL TECHNICIAN-CONFIDENTIAL	6.00	6.00	6.00	0.00
80J97	SENIOR PAYROLL TECHNICIAN - CONFIDENTIAL	2.00	2.00	2.00	0.00
80J98	SUPERVISING PAYROLL COORDINATOR- CONFIDENTIAL	1.00	1.00	1.00	0.00
Total		43.00	44.00	56.50	12.50

Auditor-Controller

Augmentation Requests

Request Code	Request Name	Ranking Type Name	Requested Amount	Requested FTE	Recommended Budget	Recommended FTE
1110-8372-001-AUG1	New Accounting Technician	Request New Position	107,906	1.00	-	-
1110-8372-001-AUG6	Accountant Auditor II	ERP Replacement Project Backfill	-	1.00	-	1.00
1110-8372-001-AUG7	Accountant Auditor III	ERP Replacement Project Backfill	-	1.00	-	1.00
1110-8372-001-AUG8	Auditor Controller Analyst I	ERP Replacement Project Backfill	-	1.00	-	1.00
1110-8373-001-AUG10	ERP Business Analyst	ERP Replacement Project Backfill	-	1.00	-	1.00

Augmentation Requests

1110-8373-001-AUG11	ERP Business Analyst	ERP Replacement Project Backfill	-	1.00	-	1.00
1110-8373-001-AUG9	ERP Business Analyst	ERP Replacement Project Backfill	-	1.00	-	1.00
1110-8374-001-AUG12	Accountant Auditor III	ERP Replacement Project Backfill	-	1.00	-	1.00
1110-8374-001-AUG13	Auditor Controller Analyst I	ERP Replacement Project Backfill	-	1.00	-	1.00
1110-8374-001-AUG14	Auditor Controller Analyst I	ERP Replacement Project Backfill	-	1.00	-	1.00
1110-8374-001-AUG15	Auditor Controller Analyst II	ERP Replacement Project Backfill	-	1.00	-	1.00
1110-8374-001-AUG16	Auditor Controller Analyst II	ERP Replacement Project Backfill	-	1.00	-	1.00
1110-8374-001-AUG18	Chief Deputy Auditor Controller	ERP Replacement Project Backfill	-	1.00	-	1.00
1110-8374-001-AUG5	New Accountant Auditor II	Request New Position	137,255	1.00	-	-
1110-8375-001-AUG2	New Internal Auditor II	Request New Position	137,255	1.00	-	-
1110-8375-001-AUG4	New Internal Auditor III	Request New Position	165,809	1.00	-	-
Grand Total:			\$548,225	16.00	\$ -	12.00

Auditor-Controller Departmental

Use of Funds

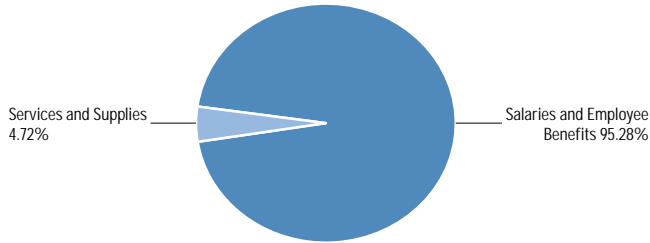

Source of Funds

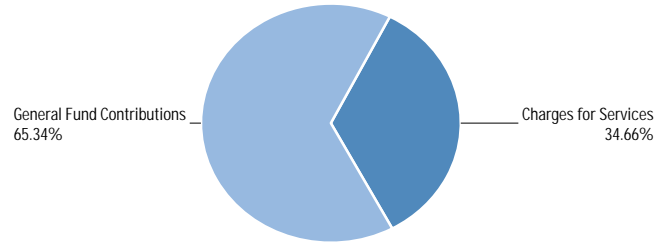

Use of Funds

Expenditures	Prior Year 2021-2022	Adopted Budget 2022-2023	CY Estimate 2022-2023	Requested Budget 2023-2024	Recommended Budget 2023-2024	Recommended Change from Adopted
Salaries and Employee Benefits	\$5,881,870	\$7,144,140	\$6,710,730	\$10,229,732	\$9,681,507	\$2,537,367
Services and Supplies	\$469,945	\$431,794	\$549,798	\$479,364	\$479,364	\$47,570
Other Charges	\$(5,424,946)	\$(5,787,150)	\$(5,787,150)	\$(8,077,822)	\$(8,077,822)	\$(2,290,672)
Capital Assets	\$33,544	—	—	—	—	—
Subtotal	\$960,413	\$1,788,784	\$1,473,378	\$2,631,274	\$2,083,049	\$294,265

Source of Funds

Revenues	Prior Year 2021-2022	Adopted Budget 2022-2023	CY Estimate 2022-2023	Requested Budget 2023-2024	Recommended Budget 2023-2024	Recommended Change from Adopted
Charges for Services	\$732,737	\$593,371	\$607,845	\$722,060	\$722,060	\$128,689
Miscellaneous Revenues	\$30	—	—	—	—	—
Subtotal	\$732,768	\$593,371	\$607,845	\$722,060	\$722,060	\$128,689
General Fund Contributions	\$227,645	\$1,195,413	\$865,533	\$1,909,214	\$1,360,989	\$165,576
Total Source of Funds	\$960,413	\$1,788,784	\$1,473,378	\$2,631,274	\$2,083,049	\$294,265

Division Description

The Office of the Auditor-Controller is organized into five divisions: Auditor-Controller (Administration), Disbursement, General Accounting, Internal Audit, and Systems Management.

appropriations with total expenditures of \$10,160,871, financed by estimated revenue of \$722,060, \$5,832,905 cost plan credit, \$2,244,917 in interfund reimbursements and a GFC contribution of \$1,360,989. Expenditures grew by \$294,265 from FY 2022-23 mainly due to negotiated salaries and employee health insurance cost. The Recommended Budget includes an additional 12 backfill positions for the implementation of the ERP replacement project funded by interfund reimbursements from Fund 478 Enterprise Resource Planning.

Summary of Recommendation

The Fiscal Year (FY) 2023-24 Recommended Budget for the Office of the Auditor-Controller departmental units is \$2,083,049 in

Appropriation Expenditure Detail

	Prior Year 2021-2022	Adopted Budget 2022-2023	CY Estimate 2022-2023	Requested Budget 2023-2024	Recommended Budget 2023-2024	Recommended Change from Adopted	Fund Code	Budget Unit Code
Auditor Controller (AUD001)	(4,390,245)	(4,651,511)	(4,597,895)	(4,655,541)	(4,655,541)	(4,030)	001	8011
Debt Management (AUD001)	1,752	0	0	0	0	0	001	8371
Disbursements (AUD001)	2,549,748	2,860,045	2,738,394	3,231,685	3,123,779	263,734	001	8372
Systems Management (AUD001)	870,964	1,327,655	1,079,348	1,258,262	1,258,262	(69,393)	001	8373
General Accounting (AUD001)	1,644,807	1,879,463	1,907,674	2,092,875	1,955,620	76,157	001	8374
Internal Audit (AUD001)	285,139	373,132	345,857	703,993	400,929	27,797	001	8375
Subtotal	\$962,165	\$1,788,784	\$1,473,378	\$2,631,274	\$2,083,049	\$294,265		

Auditor Controller

(Budget Unit 8011—Fund 001—Appropriation Unit AUD001)

Use of Funds

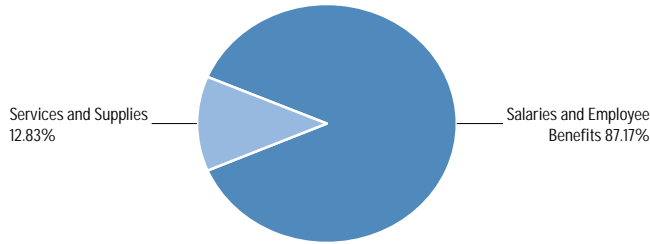

Source of Funds

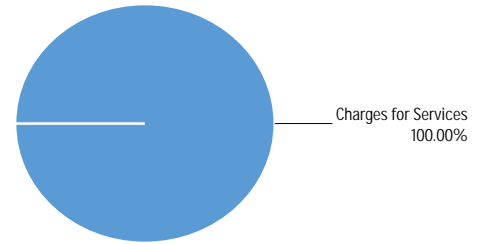

Use of Funds

Expenditures	Prior Year 2021-2022	Adopted Budget 2022-2023	CY Estimate 2022-2023	Requested Budget 2023-2024	Recommended Budget 2023-2024	Recommended Change from Adopted
Salaries and Employee Benefits	\$850,795	\$996,678	\$1,014,949	\$1,026,259	\$1,026,259	\$29,581
Services and Supplies	\$131,676	\$138,961	\$174,306	\$151,105	\$151,105	\$12,144
Other Charges	\$(5,406,260)	\$(5,787,150)	\$(5,787,150)	\$(5,832,905)	\$(5,832,905)	\$(45,755)
Capital Assets	\$33,544	—	—	—	—	—
Subtotal	\$(4,390,245)	\$(4,651,511)	\$(4,597,895)	\$(4,655,541)	\$(4,655,541)	\$(4,030)

Source of Funds

Revenues	Prior Year 2021-2022	Adopted Budget 2022-2023	CY Estimate 2022-2023	Requested Budget 2023-2024	Recommended Budget 2023-2024	Recommended Change from Adopted
Charges for Services	\$429,011	\$403,861	\$418,335	\$418,335	\$418,335	\$14,474
Miscellaneous Revenues	\$30	—	—	—	—	—
Subtotal	\$429,042	\$403,861	\$418,335	\$418,335	\$418,335	\$14,474
General Fund Contributions	\$(4,819,287)	\$(5,055,372)	\$(5,016,230)	\$(5,073,876)	\$(5,073,876)	\$(18,504)
Total Source of Funds	\$(4,390,245)	\$(4,651,511)	\$(4,597,895)	\$(4,655,541)	\$(4,655,541)	\$(4,030)

Unit Description

Auditor-Controller (Administration) Division is responsible for Department administration, strategic planning and policy guidance. Responsibilities include: employee development, budget development and management, general administrative support services, contract development, and high level staff supervision. Administration also provides overall guidance and direction to the County's System of Record, Enterprise Resource Planning (ERP) which includes: Performance Budget, Advantage Financial and Advantage Human Resource Management (HRM), SymPro Debt and Investment, and Convey Taxport.

The Division interfaces with the cities, Monterey County Department of Education, school districts, Monterey Regional Airport District,

Monterey Regional Water Pollution Control Agency, and independent special districts including fire districts, recreation districts and regional park districts providing consultation for financing, property taxes and Successor (former Redevelopment) Agency issues.

Recommended FY 2023-24 Positions

Classification Code	Classification Label	FTE
10B02	AUDITOR-CONTROLLER	1.00
12A02	ASSISTANT AUDITOR-CONTROLLER	1.00
14B32	SENIOR PERSONNEL ANALYST	0.50
14C71	ADMINISTRATIVE SERVICES OFFICER	1.00
80J21	ACCOUNT CLERK	1.00
Total		4.50

Disbursements

(Budget Unit 8372—Fund 001—Appropriation Unit AUD001)

Use of Funds

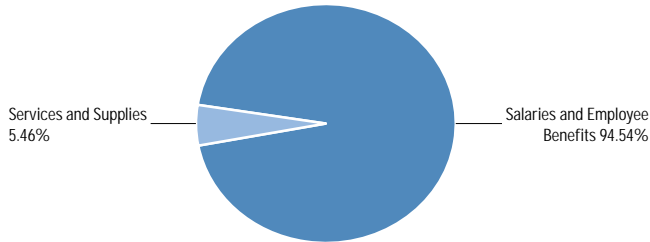

Source of Funds

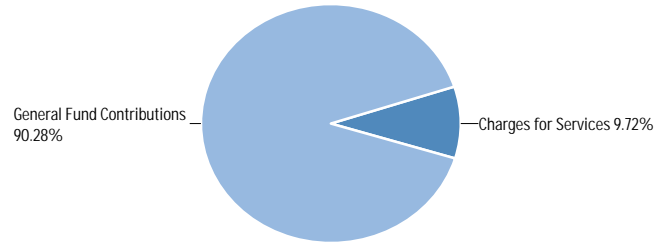

Use of Funds

Expenditures	Prior Year 2021-2022	Adopted Budget 2022-2023	CY Estimate 2022-2023	Requested Budget 2023-2024	Recommended Budget 2023-2024	Recommended Change from Adopted
Salaries and Employee Benefits	\$2,369,572	\$2,685,621	\$2,555,997	\$3,522,775	\$3,414,869	\$729,248
Services and Supplies	\$186,865	\$174,424	\$182,397	\$197,147	\$197,147	\$22,723
Other Charges	\$(6,689)	—	—	\$(488,237)	\$(488,237)	\$(488,237)
Subtotal	\$2,549,748	\$2,860,045	\$2,738,394	\$3,231,685	\$3,123,779	\$263,734

Source of Funds

Revenues	Prior Year 2021-2022	Adopted Budget 2022-2023	CY Estimate 2022-2023	Requested Budget 2023-2024	Recommended Budget 2023-2024	Recommended Change from Adopted
Charges for Services	\$303,726	\$189,510	\$189,510	\$303,725	\$303,725	\$114,215
Subtotal	\$303,726	\$189,510	\$189,510	\$303,725	\$303,725	\$114,215
General Fund Contributions	\$2,246,022	\$2,670,535	\$2,548,884	\$2,927,960	\$2,820,054	\$149,519
Total Source of Funds	\$2,549,748	\$2,860,045	\$2,738,394	\$3,231,685	\$3,123,779	\$263,734

Unit Description

The Disbursements Division is responsible for Accounts Payable, Payroll and Property Tax and provides service to independent special districts.

The Accounts Payable section audits and prepares vendor payments, credit card payments and required Internal Revenue Service (IRS) and California State Franchise Tax Board report information.

The Payroll section prepares bi-weekly checks, calculates benefit and year-end tax information, reviews and processes employee reimbursement claim payments, and reconciles payroll functions. The Payroll section also calculates and reports required payroll taxes, CalPERS payments, employee benefit payments as well as annual IRS and Franchise Tax Board reports. Garnishments, liens, and levies are also processed.

The Property Tax Section is responsible for calculating property taxes and processing property tax refunds, maintaining the property tax rolls and tax allocation systems, and allocating and accounting for property tax apportionments. This section publishes the Monterey County Tax Rates book each year based on additional information provided by the County Assessor and from direct taxing entities (cities, special districts, fire districts, school districts, etc.). After property taxes are collected, this section accounts for and apportions (distributes) property taxes to the appropriate taxing entities. No property tax funds may be disbursed without the approval of the Auditor-Controller's Office.

As a result of the dissolution of redevelopment agencies in the State, the Auditor-Controller's Office has been given a variety of additional responsibilities. The Auditor-Controller administers the Redevelopment Property Tax Trust Fund for the benefit of the holders of the former redevelopment agency enforceable obligations and taxing entities that receive pass-through payments and distributions of property taxes pursuant to legislation.

Recommended FY 2023-24 Positions

Classification Code	Classification Label	FTE
20B21	ACCOUNTANT AUDITOR II	2.00
20B22	ACCOUNTANT AUDITOR III	4.00
20B24	AUDITOR-CONTROLLER ANALYST I	3.00
20B25	AUDITOR-CONTROLLER ANALYST II	1.00
20B97	CHIEF DEPUTY AUDITOR-CONTROLLER	1.00
80J30	ACCOUNTING TECHNICIAN	4.00
80J96	PAYROLL TECHNICIAN-CONFIDENTIAL	6.00
80J97	SENIOR PAYROLL TECHNICIAN - CONFIDENTIAL	2.00
80J98	SUPERVISING PAYROLL COORDINATOR-CONFIDENTIAL	1.00
	Total	24.00

Systems Management

(Budget Unit 8373—Fund 001—Appropriation Unit AUD001)

Use of Funds

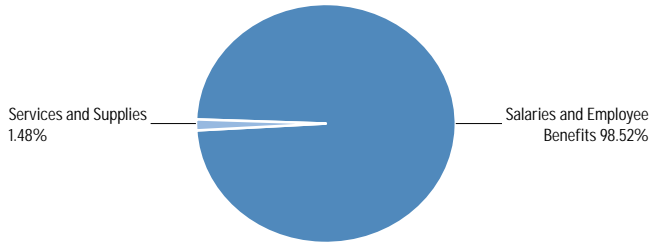

Source of Funds

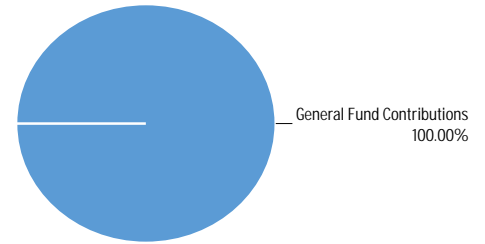

Use of Funds

Expenditures	Prior Year 2021-2022	Adopted Budget 2022-2023	CY Estimate 2022-2023	Requested Budget 2023-2024	Recommended Budget 2023-2024	Recommended Change from Adopted
Salaries and Employee Benefits	\$856,670	\$1,300,988	\$1,051,143	\$1,808,931	\$1,808,931	\$507,943
Services and Supplies	\$18,502	\$26,667	\$28,205	\$27,086	\$27,086	\$419
Other Charges	\$(4,208)	—	—	\$(577,755)	\$(577,755)	\$(577,755)
Subtotal	\$870,964	\$1,327,655	\$1,079,348	\$1,258,262	\$1,258,262	\$(69,393)

Source of Funds

Revenues	Prior Year 2021-2022	Adopted Budget 2022-2023	CY Estimate 2022-2023	Requested Budget 2023-2024	Recommended Budget 2023-2024	Recommended Change from Adopted
General Fund Contributions	\$870,964	\$1,327,655	\$1,079,348	\$1,258,262	\$1,258,262	\$(69,393)
Total Source of Funds	\$870,964	\$1,327,655	\$1,079,348	\$1,258,262	\$1,258,262	\$(69,393)

Unit Description

The Office of the Auditor-Controller maintains the official financial system of record of the County and is responsible for the business computer systems that support the accumulation and reporting of these official records. These systems include Megabyte Property Tax system, SymPro Debt, and the Enterprise Resource Planning (ERP) system, namely CGI Advantage, to include the following modules: Performance Budget, Advantage Financial, Advantage HRM, Vendor Self Service, Employee Self Service, InfoAdvantage reporting.

Systems Management provides procurement, development, implementation and production support for countywide and

department-administered systems in collaboration with the Information Technology Department, other agencies and vendors. Systems Management is staffed by ERP Business Analysts who provide countywide end user business solutions, assure business requirements are met and operations are effective and efficient.

Recommended FY 2023-24 Positions

Classification Code	Classification Label	FTE
14P32	ERP BUSINESS ANALYST	8.00
16F41	DEPARTMENTAL INFORMATION SYSTEMS MANAGER II	1.00
Total		9.00

General Accounting

(Budget Unit 8374—Fund 001—Appropriation Unit AUD001)

Use of Funds

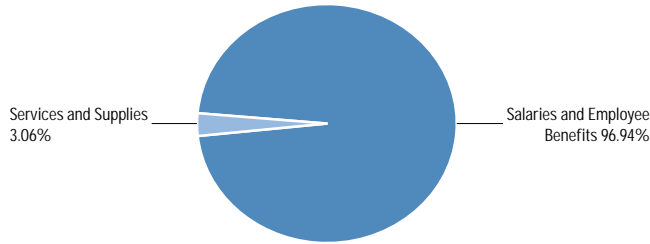

Source of Funds

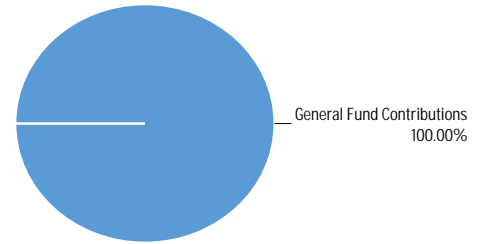

Use of Funds

Expenditures	Prior Year 2021-2022	Adopted Budget 2022-2023	CY Estimate 2022-2023	Requested Budget 2023-2024	Recommended Budget 2023-2024	Recommended Change from Adopted
Salaries and Employee Benefits	\$1,525,570	\$1,792,797	\$1,747,174	\$3,176,034	\$3,038,779	\$1,245,982
Services and Supplies	\$127,026	\$86,666	\$160,500	\$95,766	\$95,766	\$9,100
Other Charges	\$(7,789)	—	—	\$(1,178,925)	\$(1,178,925)	\$(1,178,925)
Subtotal	\$1,644,807	\$1,879,463	\$1,907,674	\$2,092,875	\$1,955,620	\$76,157

Source of Funds

Revenues	Prior Year 2021-2022	Adopted Budget 2022-2023	CY Estimate 2022-2023	Requested Budget 2023-2024	Recommended Budget 2023-2024	Recommended Change from Adopted
General Fund Contributions	\$1,644,807	\$1,879,463	\$1,907,674	\$2,092,875	\$1,955,620	\$76,157
Total Source of Funds	\$1,644,807	\$1,879,463	\$1,907,674	\$2,092,875	\$1,955,620	\$76,157

Unit Description

General Accounting maintains the County’s official system of record, produces, approves and enforces accounting policies, procedures and processes, ensures financial reporting in accordance with Generally Accepted Accounting Principles (GAAP), and ensures County policies and State and federal guidelines are followed. The Unit also prepares the Adopted Budget Book, enforces budgetary controls, and reconciles fixed asset activity to County inventory. General Accounting is responsible for the preparation of the Annual Comprehensive Financial Report (ACFR) and compilation of program data for the Single Audit Report in accordance with Uniform Guidance. The Unit prepares the Countywide Cost Allocation Plan (COWCAP) in accordance with Office of Management and Budget (OMB) 2 CFR Part 200, which is used to claim reimbursement of indirect costs from the federal and State governments. This Unit is also responsible for continuing debt disclosure filings for the County as well as making the debt payments for the County and school

districts. In addition, the Unit calculates GANN Limit for the County and Board of Supervisors governed special districts, prepares the State Controller Financial Transactions Reports, monitors countywide external checking accounts, coordinates Countywide Senate Bill (SB) 90 claiming activities, performs public safety accounting and reporting for Proposition 172, performs Realignment Sales Tax accounting, and monitors the County’s franchise fee collection.

Recommended FY 2023-24 Positions

Classification Code	Classification Label	FTE
20B22	ACCOUNTANT AUDITOR III	5.00
20B24	AUDITOR-CONTROLLER ANALYST I	5.00
20B25	AUDITOR-CONTROLLER ANALYST II	4.00
20B97	CHIEF DEPUTY AUDITOR-CONTROLLER	2.00
80J30	ACCOUNTING TECHNICIAN	1.00
Total		17.00

Internal Audit

(Budget Unit 8375—Fund 001—Appropriation Unit AUD001)

Use of Funds

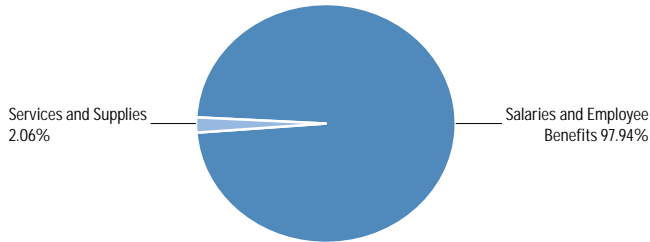

Source of Funds

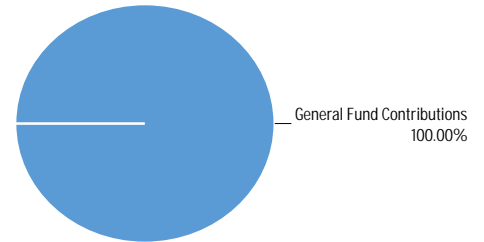

Use of Funds

Expenditures	Prior Year 2021-2022	Adopted Budget 2022-2023	CY Estimate 2022-2023	Requested Budget 2023-2024	Recommended Budget 2023-2024	Recommended Change from Adopted
Salaries and Employee Benefits	\$279,262	\$368,056	\$341,467	\$695,733	\$392,669	\$24,613
Services and Supplies	\$5,876	\$5,076	\$4,390	\$8,260	\$8,260	\$3,184
Subtotal	\$285,139	\$373,132	\$345,857	\$703,993	\$400,929	\$27,797

Source of Funds

Revenues	Prior Year 2021-2022	Adopted Budget 2022-2023	CY Estimate 2022-2023	Requested Budget 2023-2024	Recommended Budget 2023-2024	Recommended Change from Adopted
General Fund Contributions	\$285,139	\$373,132	\$345,857	\$703,993	\$400,929	\$27,797
Total Source of Funds	\$285,139	\$373,132	\$345,857	\$703,993	\$400,929	\$27,797

Unit Description

The Internal Audit Unit promotes efficiency and effectiveness by developing and executing audit programs designed to examine, verify, and analyze financial records, operating procedures, and systems of internal control for County departments, special districts, and other agencies. Audit reports presented to management include unbiased, objective analyses, appraisals, comments, and recommendations

pertaining to departmental achievement of stated objectives and effectiveness of existing internal controls.

Recommended FY 2023-24 Positions

Classification Code	Classification Label	FTE
20B31	INTERNAL AUDITOR II	1.00
20B97	CHIEF DEPUTY AUDITOR-CONTROLLER	1.00
	Total	2.00

Auditor-Controller Non-Departmental

Use of Funds

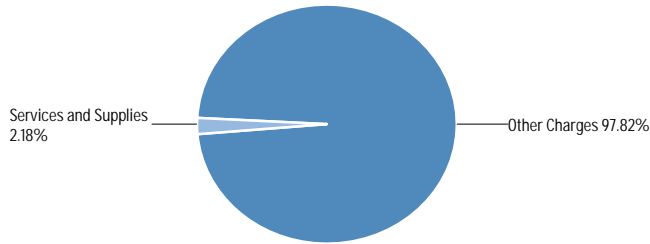

Source of Funds

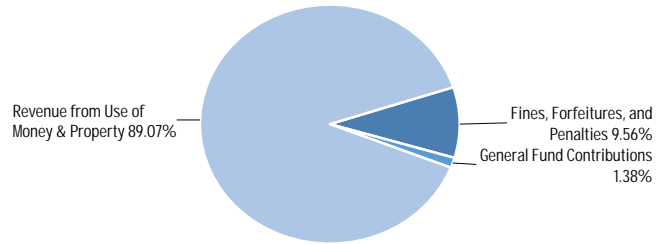

Use of Funds

Expenditures	Prior Year 2021-2022	Adopted Budget 2022-2023	CY Estimate 2022-2023	Requested Budget 2023-2024	Recommended Budget 2023-2024	Recommended Change from Adopted
Services and Supplies	\$67,671	\$137,885	\$137,885	\$341,570	\$341,570	\$203,685
Other Charges	\$15,915,849	\$15,959,525	\$15,959,525	\$15,355,335	\$15,355,335	\$(604,190)
Subtotal	\$15,983,520	\$16,097,410	\$16,097,410	\$15,696,905	\$15,696,905	\$(400,505)

Source of Funds

Revenues	Prior Year 2021-2022	Adopted Budget 2022-2023	CY Estimate 2022-2023	Requested Budget 2023-2024	Recommended Budget 2023-2024	Recommended Change from Adopted
Fines, Forfeitures, and Penalties	—	\$1,500,000	\$1,500,000	\$1,500,000	\$1,500,000	—
Revenue from Use of Money & Property	\$5,927,070	\$14,478,525	\$14,478,525	\$13,980,525	\$13,980,525	\$(498,000)
Other Financing Sources	\$10,061,799	—	—	—	—	—
Subtotal	\$15,988,869	\$15,978,525	\$15,978,525	\$15,480,525	\$15,480,525	\$(498,000)
Fund Balance	\$1,481	—	—	—	—	—
General Fund Contributions	\$(6,830)	\$118,885	\$118,885	\$216,380	\$216,380	\$97,495
Total Source of Funds	\$15,983,520	\$16,097,410	\$16,097,410	\$15,696,905	\$15,696,905	\$(400,505)

Division Description

The Office of the Auditor-Controller non-departmental operations includes two units: Public Improvement Corporation Debt Service, and Annual Audits.

Summary of Recommendation

The Recommended Budget for the Auditor-Controller non-departmental operations is \$15,696,905, a decrease of \$400,505 over FY 2022-23 mainly due to lower bond related expenditures.

Appropriation Expenditure Detail

	Prior Year 2021-2022	Adopted Budget 2022-2023	CY Estimate 2022-2023	Requested Budget 2023-2024	Recommended Budget 2023-2024	Recommended Change from Adopted	Fund Code	Budget Unit Code
PIC Debt Service (AUD005)	15,990,350	15,978,525	15,978,525	15,480,525	15,480,525	(498,000)	251	8007
Annual Audits (AUD002)	(6,830)	118,885	118,885	216,380	216,380	97,495	001	8010
Subtotal	\$15,983,520	\$16,097,410	\$16,097,410	\$15,696,905	\$15,696,905	\$(400,505)		

PIC Debt Service

(Budget Unit 8007—Fund 251—Appropriation Unit AUD005)

Use of Funds

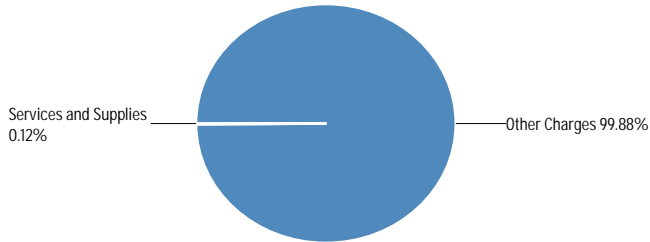

Source of Funds

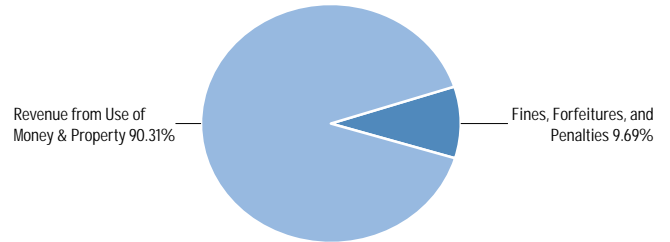

Use of Funds

Expenditures	Prior Year 2021-2022	Adopted Budget 2022-2023	CY Estimate 2022-2023	Requested Budget 2023-2024	Recommended Budget 2023-2024	Recommended Change from Adopted
Services and Supplies	\$7,450	\$19,000	\$19,000	\$19,000	\$19,000	—
Other Charges	\$15,982,900	\$15,959,525	\$15,959,525	\$15,461,525	\$15,461,525	\$(498,000)
Subtotal	\$15,990,350	\$15,978,525	\$15,978,525	\$15,480,525	\$15,480,525	\$(498,000)

Source of Funds

Revenues	Prior Year 2021-2022	Adopted Budget 2022-2023	CY Estimate 2022-2023	Requested Budget 2023-2024	Recommended Budget 2023-2024	Recommended Change from Adopted
Fines, Forfeitures, and Penalties	—	\$1,500,000	\$1,500,000	\$1,500,000	\$1,500,000	—
Revenue from Use of Money & Property	\$5,927,070	\$14,478,525	\$14,478,525	\$13,980,525	\$13,980,525	\$(498,000)
Other Financing Sources	\$10,061,799	—	—	—	—	—
Subtotal	\$15,988,869	\$15,978,525	\$15,978,525	\$15,480,525	\$15,480,525	\$(498,000)
Fund Balance	\$1,481	—	—	—	—	—
Total Source of Funds	\$15,990,350	\$15,978,525	\$15,978,525	\$15,480,525	\$15,480,525	\$(498,000)

Unit Description

The Public Improvement Corporation (PIC) Debt Service funds debt payments and related expenses for Certificates of Participation (COPs) issued by the PIC. COPs are long-term financial

commitments whereby the County transfers title of a particular property to the PIC. The PIC then leases the facility back to the County and sells participation in the lease revenue stream to investors in the form of bonds.

Annual Audits

(Budget Unit 8010—Fund 001—Appropriation Unit AUD002)

Use of Funds

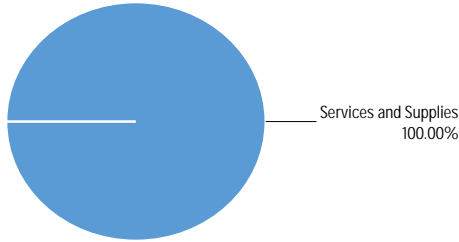

Source of Funds

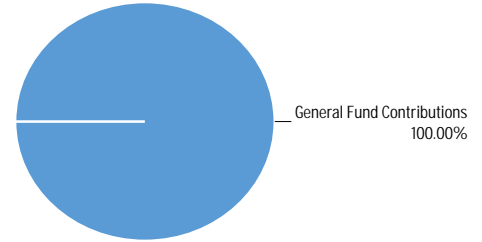

Use of Funds

Expenditures	Prior Year 2021-2022	Adopted Budget 2022-2023	CY Estimate 2022-2023	Requested Budget 2023-2024	Recommended Budget 2023-2024	Recommended Change from Adopted
Services and Supplies	\$60,221	\$118,885	\$118,885	\$322,570	\$322,570	\$203,685
Other Charges	\$(67,051)	—	—	\$(106,190)	\$(106,190)	\$(106,190)
Subtotal	\$(6,830)	\$118,885	\$118,885	\$216,380	\$216,380	\$97,495

Source of Funds

Revenues	Prior Year 2021-2022	Adopted Budget 2022-2023	CY Estimate 2022-2023	Requested Budget 2023-2024	Recommended Budget 2023-2024	Recommended Change from Adopted
General Fund Contributions	\$(6,830)	\$118,885	\$118,885	\$216,380	\$216,380	\$97,495
Total Source of Funds	\$(6,830)	\$118,885	\$118,885	\$216,380	\$216,380	\$97,495

Unit Description

Annual Audits includes funding for the Sales and Use Tax audit, SB 90 State Mandate claiming services, and contracted audits required by the Auditor-Controller. The Sales and Use Tax audit identifies and recovers sales and use tax allocation errors, helps maximize tax

revenues from specific projects and business situations, and provides ongoing data, analyses, and staff expertise to support fiscal planning and economic development. State law (SB 90) provides for reimbursement of costs incurred by local agencies for various State-mandated services.

Treasurer-Tax Collector

Departmental Overview:

The Treasurer-Tax Collector serves the residents of Monterey County and public agencies by protecting the public trust through the delivery of valuable professional and innovative services in the collection of property taxes, other County taxes, fines and fees, and through the implementation and oversight of banking and investment services.

Programs and Functions:

California Government Code Section 27000 directs the Treasurer-Tax Collector, who is elected at large by the voters of Monterey County and serves as a department head within the County organization. The Department of the Treasurer-Tax Collector includes 49 staff members dedicated to performing the duties of the three divisional units: Property Tax, Revenue Division, and Treasury.

Property Tax - Administration and enforcement of State law and County Code providing for collection of all property taxes on behalf of the County, all school districts, cities, special districts, community service districts and libraries throughout Monterey County. The Property Tax Division also collects transient occupancy taxes (TOT) and commercial cannabis business taxes from related businesses in unincorporated areas of the County and administers the County's Business License Ordinance, including requirements for the issuance, annual review, and renewal of business licenses for unincorporated area permitted cannabis operations. These activities historically provide the County's largest sources of annual discretionary revenues, supporting the ability to achieve a balanced budget that sustains core services and efficiently allocates resources to address local priorities and Board established strategic initiatives.

Revenue Division - In-house collection services for various operating departments, including Probation, Public Defender, and Sheriff. The bulk of the Revenue Division's activities involve the billing and collection of court-ordered fines and fees through agreement with the local Superior Court of California, which provides for the Division to recover its costs from a portion of funds collected.

Treasury - Safeguards and prudently invests all deposits for the County, all school districts, and numerous special districts in Monterey County. Treasury responsibility includes oversight and management of a pooled portfolio that provides for the safety and liquidity of all cash assets.

Department's Contributions to Monterey County's Strategic Initiatives:

ADMINISTRATION

The Treasurer-Tax Collector is committed to efficient and effective resource management, and is recognized for responsiveness, strong customer service orientation, accountability, and transparency. The departmental culture includes a broad focus on continual evaluation of operational functions to improve efficiency and effectiveness of County services, deliver excellent customer service, increase general fund revenue, and minimize the cost of collections.



Treasurer-Tax Collector

Operating Budget: \$9,928,945
Positions (FTEs): 49.00

Mary Zeeb
Treasurer-Tax Collector

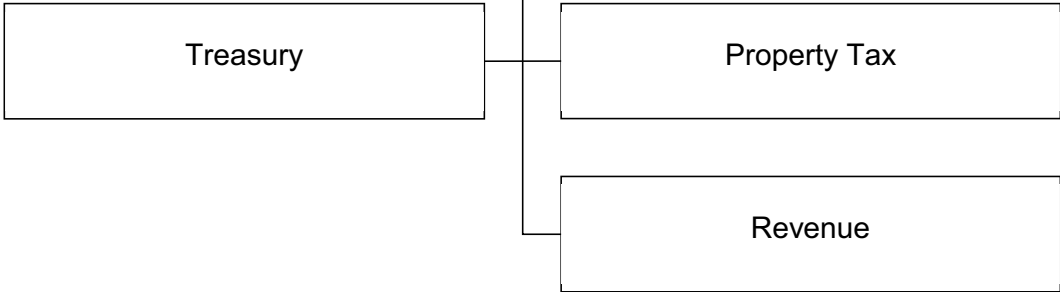

Staffing Trends

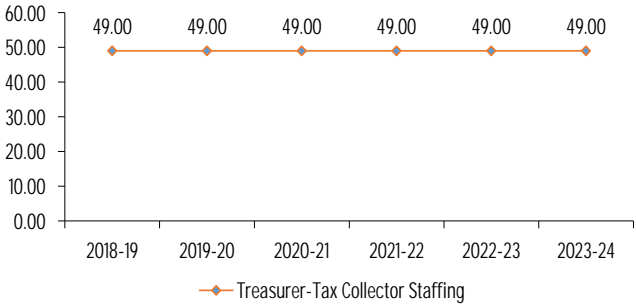

Expenditure/Revenue History (in millions)

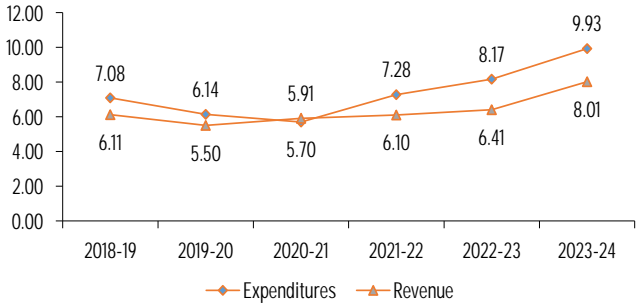

The Department tracks key performance measures to monitor the success and effectiveness of departmental activities and professional services relevant to Treasury banking and investment services, the collection of transient occupancy taxes (TOT) and the collection of property and cannabis business taxes by the Tax Division, as well as customer service ratings related to Court ordered fines, fees, and restitution collected through the collections program.

Key Performance Measures	2020-21 Actual	2021-22 Actual	2022-23 Mid-Year
Treasury – Percentage of invested portfolio maintaining a weighted average maturity (WAM) of two years or less. Target = 100%	100%	100%	100%
Tax – Percentage of property taxes collected – secured. Target (annual) = 97%	98.9%	99.0%	98.8%
Tax – Percentage of property taxes collected – unsecured. Target = 96%	97.4%	97.5%	97.0%
Revenue – Percentage of customers who rate services received as excellent. Target = 90%	99.5%	99.6%	99.1%

Use of Funds

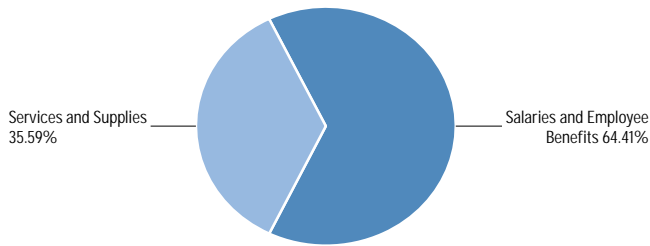

Source of Funds

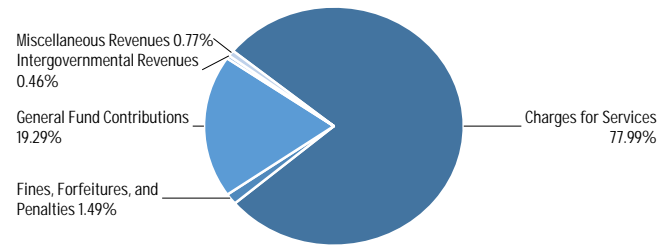

Use of Funds

Expenditures	Prior Year 2021-2022	Adopted Budget 2022-2023	CY Estimate 2022-2023	Requested Budget 2023-2024	Recommended Budget 2023-2024	Recommended Change from Adopted
Salaries and Employee Benefits	\$5,616,993	\$7,001,216	\$5,700,542	\$7,125,866	\$7,125,866	\$124,650
Services and Supplies	\$2,982,754	\$3,399,059	\$3,438,666	\$3,936,957	\$3,936,957	\$537,898
Other Charges	\$(1,321,309)	\$(885,761)	\$(967,140)	\$(1,133,878)	\$(1,133,878)	\$(248,117)
Subtotal	\$7,278,438	\$9,514,514	\$8,172,068	\$9,928,945	\$9,928,945	\$414,431

Source of Funds

Revenues	Prior Year 2021-2022	Adopted Budget 2022-2023	CY Estimate 2022-2023	Requested Budget 2023-2024	Recommended Budget 2023-2024	Recommended Change from Adopted
Licenses, Permits, and Franchises	\$8,936	\$6,110	\$9,150	\$8,150	\$8,150	\$2,040
Fines, Forfeitures, and Penalties	\$153,300	\$146,680	\$153,300	\$147,740	\$147,740	\$1,060
Intergovernmental Revenues	\$56,884	\$34,000	\$40,000	\$45,400	\$45,400	\$11,400
Charges for Services	\$5,817,849	\$7,183,296	\$6,141,700	\$7,737,008	\$7,737,008	\$553,712
Miscellaneous Revenues	\$64,465	\$81,480	\$62,266	\$76,638	\$76,638	\$(4,842)
Subtotal	\$6,101,434	\$7,451,566	\$6,406,416	\$8,014,936	\$8,014,936	\$563,370
General Fund Contributions	\$1,177,004	\$2,062,948	\$1,765,652	\$1,914,009	\$1,914,009	\$(148,939)
Total Source of Funds	\$7,278,438	\$9,514,514	\$8,172,068	\$9,928,945	\$9,928,945	\$414,431

Summary of Recommendation

The Recommended Budget for the Treasurer-Tax Collector (TTC) is \$9,928,945 in appropriations with total expenditures of \$11,062,823, financed by estimated revenues of \$8,014,936, \$155,612 cost plan credits, \$978,266 in intrafund reimbursements, and a general fund contribution (GFC) of \$1,914,009. Expenditures reflect an increase of \$414,431. The increase is primarily attributed to negotiated salaries, Public Employees Retirement System (PERS) contributions, healthcare benefits, workers compensation, earned annual step increases, and banking and investment services as TTC continues to experience a growth in assets; offset by cost plan credits. Revenue is projected to increase by \$563,370 primarily from increased cost recovery service charges for the Revenue Division and Treasury.

The Department's Recommended Budget includes an augmentation request for \$38,690 supplementing increased non-discretionary salary, benefits, and indirect charges to the cannabis business tax and business license team.

Budget Impacts

The TTC's recommended budget prioritizes retention of current staffing and existing levels of service. Costs for services and supplies have been reduced where possible to fund non-discretionary increases for salaries and benefits and internal service charges within allocated levels of available GFC and estimated revenues. Reductions to services and supplies expenditures particularly impact the Property Tax Division, which is funded almost entirely by the Department's allocation of GFC. Increases to services and supplies primarily include banking and investment services as the TTC continues to experience a growth of assets under management by the Treasury. Assembly Bills 177 and 199 decreased revenues in the Revenue Division by approximately \$927,000, and potential backfill of funds from the State Controller's Office will not make up for the total revenue loss. The Revenue Division and the majority of Treasury costs are funded through cost recovery for services provided. The TTC carefully monitors actual expenditures throughout the course of the fiscal year to minimize increased cost impacts to other public agencies that rely on TTC services, including the local Superior Court and Treasury portfolio participants. The TTC's budget, as submitted, has no flexibility to fund new workloads, programs, or unanticipated events without additional GFC.

Prior Year Accomplishments

Updated the department fee schedule to accurately represent staff effort of multiple processes and appropriately recover related departmental revenue.

Conducted annual safety training for all staff on appropriate responses to various emergency scenarios.

Increased staff development through participation in various departmentwide growth opportunities, such as cross-training, team building, and celebration of successes and service years.

Cross-trained staff to achieve effective succession planning and continuity of operations despite retirements and promotions.

Fortified employee engagement while maintaining exceptional customer service through rotational remote and in-office staffing initially began in response to the COVID-19 Pandemic.

Assisted in emergency response to Monterey County floods by deploying staff as Disaster Service Workers to shelters to service impacted residents.

Completed the annual discharge of accountability project to eliminate 26,410 uncollectible Superior Court accounts with an approximate balance of \$8.8 million.

Analyzed materials from a request for information and executed an agreement for third party collection agency services to support collection of court-ordered debt.

Programmed technical specifications in the Revenue Division's case management system to vacate fees required by Assembly Bills 177 and 199.

Implemented on-site check scanners integrated with depository bank to remote deposit checks electronically.

Preserved the safety of all invested assets while maintaining adequate liquidity for expenditures. Implemented multiple online payment solutions for customers of other County departments.

Increased timeliness and efficiency of reconciliation through education and enforcement of new fees for treasury services.

Trained staff on the County accounts payable process and to assist in timely payment of all invoices.

Deployed online business license and renewal applications and an online business license payment provision.

Implemented procedures for the collection of commercial cannabis tax collections, including a waiver of penalties for the second through fourth quarter of FY 21-22 and a payment plan for payment of delinquent FY 21-22 commercial cannabis business tax for cultivation in response to Board of Supervisor's direction.

Leveraged a third-party lockbox solution to begin processing property tax payments to ensure continuity of operations and improve efficiencies in the collection of property taxes with processing of unsecured property tax payments.

Created an Excess Proceeds Guide and claim form for parties seeking excess proceeds following the auction of tax defaulted property.

Budget Year Goals

Enhance employee engagement through regular departmental activities, such as one-on-one individual development meetings, staff job shadowing sessions, recurring teambuilding efforts, special recognition events, and departmentwide celebrations.

Engage staff in emergency preparedness, including regular cross-training, to ensure uninterrupted support of critical functions and reinforce internal commitments and requirements for Continuity of Operations Plan (COOP).

Maximize the use of SharePoint and backup hardware to secure and preserve relevant records, enhance employee remote work capabilities, increase efficiency in staff processes, and ensure seamless service for customers.

Redesign the Department's external website to increase traffic and engagement while improving the overall customer experience.

Conduct annual safety training for all staff on appropriate responses to various emergency scenarios.

Coordinate with the Probation Department and local Superior Court to complete required activities for an annual discharge of accountability of uncollectible accounts.

Upgrade the Revenue Division case management system to enable electronic funds transfer (EFT) recurring payment options, increase ease of use by staff, and add automations to streamline internal processes.

Onboard a new third-party collection agency to assist in the collection of court-ordered debt. Preserve the safety of all invested assets while ensuring adequate liquidity to meet all expenditure obligations.

Leverage additional technology and automation to increase operational efficiencies, including new cash management software in the Treasury and remote deposit capability within other County departments.

Analyze processes for improvements and streamlining to support effective operations and create additional best practices.

Facilitate online payment opportunities for County departments to optimize efficiency of revenue collection process.

Create a Transient Occupancy Tax (TOT) Handbook to educate the public and disseminate information related to TOT collection upon implementation of a short-term rental ordinance.

Implement procedures in response to changes in legislation that impact internal operations for property and commercial cannabis tax collections.

Continue working with a third-party lockbox solution to process property tax payments to ensure continuity of operations and improve efficiency in the collection of property taxes.

Pending Issues

There are no pending issues.

Policy Considerations

There are no policy considerations.

Appropriation Expenditure Detail

	Prior Year 2021-2022	Adopted Budget 2022-2023	CY Estimate 2022-2023	Requested Budget 2023-2024	Recommended Budget 2023-2024	Recommended Change from Adopted	Fund Code	Budget Unit Code
Property Tax (TRE001)	2,795,419	3,105,905	2,595,277	3,247,383	3,247,383	141,478	001	8263
Revenue (TRE001)	3,481,411	4,503,195	3,791,904	4,793,082	4,793,082	289,887	001	8264
Treasury (TRE001)	1,001,608	1,905,414	1,784,887	1,888,480	1,888,480	(16,934)	001	8266
Subtotal	\$7,278,438	\$9,514,514	\$8,172,068	\$9,928,945	\$9,928,945	\$414,431		

Budget Units

	Prior Year 2021-2022	Adopted Budget 2022-2023	CY Estimate 2022-2023	Requested Budget 2023-2024	Recommended Budget 2023-2024	Recommended Change from Adopted
Property Tax	\$2,795,419	\$3,105,905	\$2,595,277	\$3,247,383	\$3,247,383	\$141,478
Revenue	\$3,481,411	\$4,503,195	\$3,791,904	\$4,793,082	\$4,793,082	\$289,887
Treasury	\$1,001,608	\$1,905,414	\$1,784,887	\$1,888,480	\$1,888,480	\$(16,934)
Subtotal	\$7,278,438	\$9,514,514	\$8,172,068	\$9,928,945	\$9,928,945	\$414,431

Adopted FY 2022-23 to Recommended FY 2023-24 Positions

Classification Code	Classification Label	Adopted Budget 2021-2022	Adopted Budget 2022-2023	Recommended Budget 2023-2024	Change
10B06	TREASURER-TAX COLLECTOR	1.00	1.00	1.00	0.00
12A24	ASSISTANT TREASURER-TAX COLLECTOR	1.00	1.00	1.00	0.00
14C31	MANAGEMENT ANALYST III	3.00	3.00	3.00	0.00
14C45	TREASURY MANAGER	1.00	0.00	0.00	0.00
14C47	CHIEF DEPUTY TREASURER-TAX COLLECTOR	2.00	3.00	3.00	0.00
14C70	ADMINISTRATIVE SERVICES ASSISTANT	1.00	1.00	1.00	0.00
14C71	ADMINISTRATIVE SERVICES OFFICER	1.00	1.00	1.00	0.00
16C88	BUSINESS TECHNOLOGY ANALYST III	1.00	1.00	1.00	0.00
20B10	ACCOUNTANT I	1.00	1.00	1.00	0.00
20B11	ACCOUNTANT II	2.00	2.00	2.00	0.00
20B12	ACCOUNTANT III	2.00	2.00	2.00	0.00
20B41	TREASURY OFFICER II	3.00	3.00	3.00	0.00
20B93	FINANCE MANAGER II	1.00	1.00	1.00	0.00
20B95	FINANCE MANAGER I	1.00	1.00	1.00	0.00
20B96	FINANCE SYSTEMS MANAGER	1.00	1.00	1.00	0.00
25A32	REVENUE OFFICER II	9.00	9.00	9.00	0.00
25A33	SUPERVISING REVENUE OFFICER	1.00	1.00	1.00	0.00
80J21	ACCOUNT CLERK	9.00	9.00	9.00	0.00
80J22	SENIOR ACCOUNT CLERK	1.00	1.00	1.00	0.00
80J30	ACCOUNTING TECHNICIAN	7.00	7.00	7.00	0.00
	Total	49.00	49.00	49.00	0.00

Augmentation Requests

Request Code	Request Name	Ranking Type Name	Requested Amount	Requested FTE	Recommended Budget	Recommended FTE
1170-8263-001-AUG1	TTC Cannabis Program	Status Quo Other	38,203	-	38,203	-
1170-8263-001-AUG2	Remittance Processor (replacement)	Status Quo Other	135,000	-	-	-
	Grand Total:		\$173,203	-	\$38,203	-

Treasurer - Tax Collector

Property Tax

(Budget Unit 8263—Fund 001—Appropriation Unit TRE001)

Use of Funds

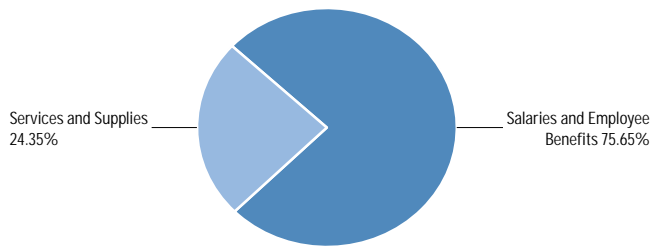

Source of Funds

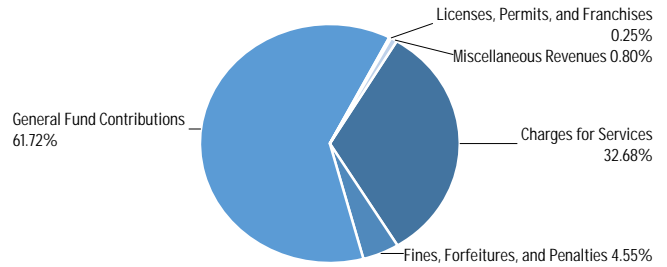

Use of Funds

Expenditures	Prior Year 2021-2022	Adopted Budget 2022-2023	CY Estimate 2022-2023	Requested Budget 2023-2024	Recommended Budget 2023-2024	Recommended Change from Adopted
Salaries and Employee Benefits	\$2,497,641	\$2,956,663	\$2,548,299	\$3,061,889	\$3,061,889	\$105,226
Services and Supplies	\$811,748	\$870,124	\$847,258	\$985,774	\$985,774	\$115,650
Other Charges	\$(513,970)	\$(720,882)	\$(800,280)	\$(800,280)	\$(800,280)	\$(79,398)
Subtotal	\$2,795,419	\$3,105,905	\$2,595,277	\$3,247,383	\$3,247,383	\$141,478

Source of Funds

Revenues	Prior Year 2021-2022	Adopted Budget 2022-2023	CY Estimate 2022-2023	Requested Budget 2023-2024	Recommended Budget 2023-2024	Recommended Change from Adopted
Licenses, Permits, and Franchises	\$8,936	\$6,110	\$9,150	\$8,150	\$8,150	\$2,040
Fines, Forfeitures, and Penalties	\$153,300	\$146,680	\$153,300	\$147,740	\$147,740	\$1,060
Charges for Services	\$1,097,890	\$1,069,564	\$1,170,461	\$1,061,350	\$1,061,350	\$(8,214)
Miscellaneous Revenues	\$20,995	\$20,480	\$18,000	\$26,000	\$26,000	\$5,520
Subtotal	\$1,281,121	\$1,242,834	\$1,350,911	\$1,243,240	\$1,243,240	\$406
General Fund Contributions	\$1,514,298	\$1,863,071	\$1,244,366	\$2,004,143	\$2,004,143	\$141,072
Total Source of Funds	\$2,795,419	\$3,105,905	\$2,595,277	\$3,247,383	\$3,247,383	\$141,478

Unit Description

The Property Tax Division oversees the billing, collection, reporting and accounting of all real and taxable personal property in Monterey County. The Division is responsible for administration and enforcement of the County's Transient Occupancy Tax (TOT) and Commercial Cannabis Business Tax Ordinances, including billing and collection of taxes from all related operators in unincorporated areas of the County. Tax functions provide for collection of the largest portions of the County's General Fund general purpose (discretionary) revenue. The Property Tax Division also administers and enforces the County's Business License Ordinance. The Ordinance currently requires initial issuance, annual review, and renewal of Business Licenses for all cannabis operations permitted in unincorporated areas of the County.

Recommended FY 2023-24 Positions

Classification Code	Classification Label	FTE
10B06	TREASURER-TAX COLLECTOR	1.00
12A24	ASSISTANT TREASURER-TAX COLLECTOR	1.00
14C31	MANAGEMENT ANALYST III	2.00
14C47	CHIEF DEPUTY TREASURER-TAX COLLECTOR	1.00
14C71	ADMINISTRATIVE SERVICES OFFICER	1.00
20B10	ACCOUNTANT I	1.00
20B11	ACCOUNTANT II	1.00
20B12	ACCOUNTANT III	1.00
20B95	FINANCE MANAGER I	1.00
20B96	FINANCE SYSTEMS MANAGER	1.00
80J21	ACCOUNT CLERK	2.00
80J22	SENIOR ACCOUNT CLERK	1.00
80J30	ACCOUNTING TECHNICIAN	4.00
Total		18.00

Revenue

(Budget Unit 8264—Fund 001—Appropriation Unit TRE001)

Use of Funds

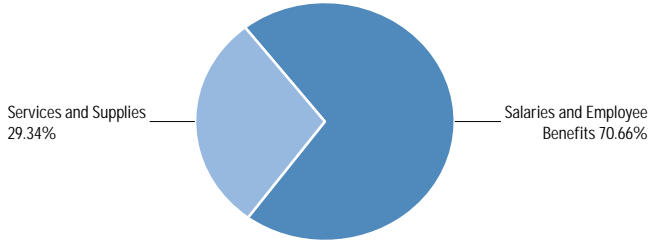

Source of Funds

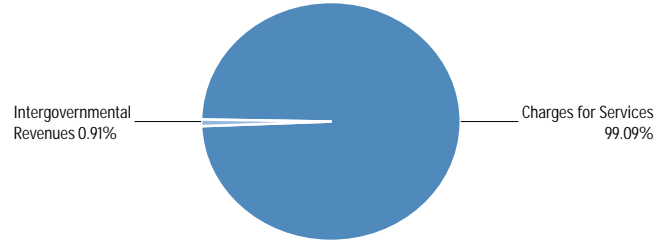

Use of Funds

Expenditures	Prior Year 2021-2022	Adopted Budget 2022-2023	CY Estimate 2022-2023	Requested Budget 2023-2024	Recommended Budget 2023-2024	Recommended Change from Adopted
Salaries and Employee Benefits	\$2,624,524	\$3,442,572	\$2,627,068	\$3,512,766	\$3,512,766	\$70,194
Services and Supplies	\$1,112,603	\$1,292,159	\$1,398,353	\$1,458,302	\$1,458,302	\$166,143
Other Charges	\$(255,716)	\$(231,536)	\$(233,517)	\$(177,986)	\$(177,986)	\$53,550
Subtotal	\$3,481,411	\$4,503,195	\$3,791,904	\$4,793,082	\$4,793,082	\$289,887

Source of Funds

Revenues	Prior Year 2021-2022	Adopted Budget 2022-2023	CY Estimate 2022-2023	Requested Budget 2023-2024	Recommended Budget 2023-2024	Recommended Change from Adopted
Intergovernmental Revenues	\$56,884	\$34,000	\$40,000	\$45,400	\$45,400	\$11,400
Charges for Services	\$3,550,068	\$4,733,016	\$3,840,167	\$4,942,954	\$4,942,954	\$209,938
Miscellaneous Revenues	\$5,574	\$4,000	\$4,000	\$3,364	\$3,364	\$(636)
Subtotal	\$3,612,526	\$4,771,016	\$3,884,167	\$4,991,718	\$4,991,718	\$220,702
General Fund Contributions	\$(131,115)	\$(267,821)	\$(92,263)	\$(198,636)	\$(198,636)	\$69,185
Total Source of Funds	\$3,481,411	\$4,503,195	\$3,791,904	\$4,793,082	\$4,793,082	\$289,887

Unit Description

The Revenue Division provides in-house collections services for various County operating departments that may levy fines and/or charge for their services. Departments served include Probation, Public Defender, and Sheriff, as well as the Superior Court of California, County of Monterey.

The Revenue Division's primary activities include the collection of Court-ordered debt (COD) on behalf of the local Superior Court of California. This includes collection of victim restitution, current and delinquent misdemeanor and felony fines and fees, delinquent infraction penalties, and court-ordered probation fees.

The Division participates in the State of California Comprehensive Collection Program (CCP) through a Board of Supervisors approved Memorandum of Understanding (MOU) with the Superior Court to recover Treasurer-Tax Collector departmental expenses incurred in the collection and distribution of court-ordered debt.

Recommended FY 2023-24 Positions

Classification Code	Classification Label	FTE
14C31	MANAGEMENT ANALYST III	1.00
14C47	CHIEF DEPUTY TREASURER-TAX COLLECTOR	1.00
14C70	ADMINISTRATIVE SERVICES ASSISTANT	1.00
16C88	BUSINESS TECHNOLOGY ANALYST III	1.00
20B11	ACCOUNTANT II	1.00
20B12	ACCOUNTANT III	1.00
20B93	FINANCE MANAGER II	1.00
25A32	REVENUE OFFICER II	9.00
25A33	SUPERVISING REVENUE OFFICER	1.00
80J21	ACCOUNT CLERK	7.00
80J30	ACCOUNTING TECHNICIAN	3.00
Total		27.00

Treasury

(Budget Unit 8266—Fund 001—Appropriation Unit TRE001)

Use of Funds

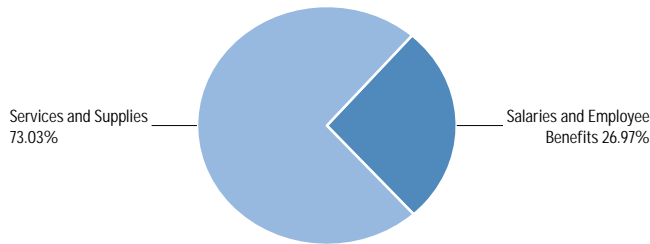

Source of Funds

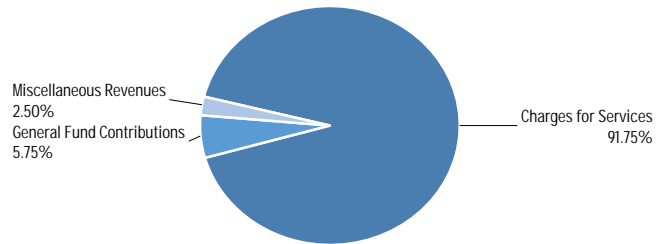

Use of Funds

Expenditures	Prior Year 2021-2022	Adopted Budget 2022-2023	CY Estimate 2022-2023	Requested Budget 2023-2024	Recommended Budget 2023-2024	Recommended Change from Adopted
Salaries and Employee Benefits	\$494,828	\$601,981	\$525,175	\$551,211	\$551,211	\$(50,770)
Services and Supplies	\$1,058,403	\$1,236,776	\$1,193,055	\$1,492,881	\$1,492,881	\$256,105
Other Charges	\$(551,623)	\$66,657	\$66,657	\$(155,612)	\$(155,612)	\$(222,269)
Subtotal	\$1,001,608	\$1,905,414	\$1,784,887	\$1,888,480	\$1,888,480	\$(16,934)

Source of Funds

Revenues	Prior Year 2021-2022	Adopted Budget 2022-2023	CY Estimate 2022-2023	Requested Budget 2023-2024	Recommended Budget 2023-2024	Recommended Change from Adopted
Charges for Services	\$1,169,891	\$1,380,716	\$1,131,072	\$1,732,704	\$1,732,704	\$351,988
Miscellaneous Revenues	\$37,896	\$57,000	\$40,266	\$47,274	\$47,274	\$(9,726)
Subtotal	\$1,207,787	\$1,437,716	\$1,171,338	\$1,779,978	\$1,779,978	\$342,262
General Fund Contributions	\$(206,179)	\$467,698	\$613,549	\$108,502	\$108,502	\$(359,196)
Total Source of Funds	\$1,001,608	\$1,905,414	\$1,784,887	\$1,888,480	\$1,888,480	\$(16,934)

Unit Description

As an elected department head, the Treasurer-Tax Collector has legal authority vested by California Government Code Section 27000, which provides that mandated agency funds be deposited and safely kept by the Treasurer. The Treasurer-Tax Collector also serves as the ex-officio Treasurer of Monterey County's 26 school districts and various special districts and performs general banking services for the County and depository agencies. The Treasurer invests and maintains

monies deposited, but not immediately needed, by managing a pooled portfolio that provides for the safety and liquidity of all cash assets.

Recommended FY 2023-24 Positions

Classification Code	Classification Label	FTE
14C47	CHIEF DEPUTY TREASURER-TAX COLLECTOR	1.00
20B41	TREASURY OFFICER II	3.00
	Total	4.00

Assessor-County Clerk-Recorder

Departmental Overview:

The Assessor-County Clerk-Recorder is an elected position. The Assessor's Office establishes the values on all property in Monterey County and applies all legal exemptions to qualifying properties. The current assessed value is in excess of \$82.9 billion, generating over \$837 million for local government agencies and schools.

Programs and Functions:

The Assessor's Office calculates the values of all real and business personal property for tax purposes. Property tax is the backbone financing for counties and incorporated cities in California and accounts for approximately two-thirds of the discretionary revenue in Monterey County. It is mandated by the State Constitution that property will be assessed "ad valorem" (based on value) of land and improvements.

The operations of the County Clerk-Recorder's Office are financed almost entirely by program revenue. In addition, the County Clerk-Recorder's Office collects documentary transfer tax that generates considerable revenue for the County and other jurisdictions. The responsibilities of the County Clerk-Recorder's Office include issuing licenses and fictitious business name statements, filing statements of economic interest, filing oaths of office and notary bonds, and registering process servers. The Recorder's duties include maintenance of public records of all real property within the County and transfers of encumbrances on property. The Recorder is also responsible for recording vital statistics such as births, deaths, and marriages.

Department's Contributions to Monterey County's Strategic Initiatives:

ECONOMIC DEVELOPMENT AND ADMINISTRATION

The Office of the Assessor-County Clerk-Recorder is committed to streamlining County operations for greater accountability and efficiency of service delivery and cost savings by producing an accurate and timely assessment roll and providing quality customer service in a courteous and professional manner.



Operating Budget: \$10,816,670
Positions (FTEs): 65.00

Marina Camacho
Assessor-County Clerk-Recorder

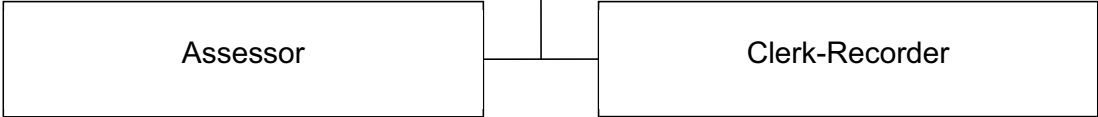

Staffing Trends

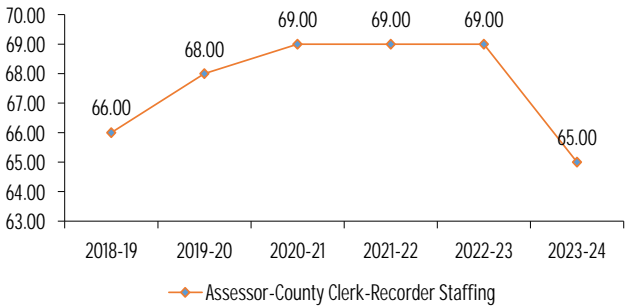

Expenditure/Revenue History (in millions)

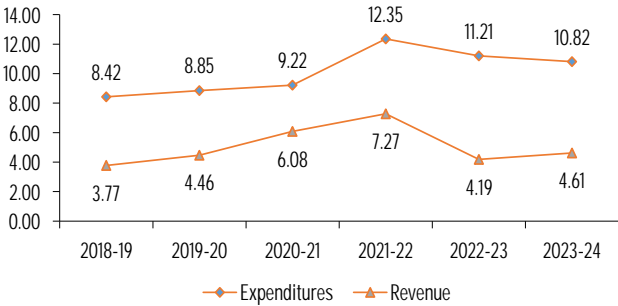

The goal of the Assessor-County Clerk-Recorder is to streamline operations for greater accountability, efficient service delivery, and cost savings by producing an accurate and timely assessment roll and providing quality customer service in a courteous and professional manner.

Key Performance Measures	2020-21 Actual	2021-22 Actual	2022-23 Mid-Year
Percent of customers rating customer service as "Excellent." Target = 95%	98%	91% (Asr) 95% (C/R)	100% (Asr) 98% (C/R)
Percent of real property assessments appraised on time. Target = 100%	100%	100%	100%
Percent of assessment appeals reconciled within 18 months of receipt. Target = 100%	100%	100%	100%
Percent of exemption forms processed within 7 days. Target = 100%	100%	100%	100%
Percent of recorded documents indexed the same day. Target = 100%	100%	100%	100%
Percent of documents electronically recorded.	79.9%	78.2%	100.0%

Use of Funds

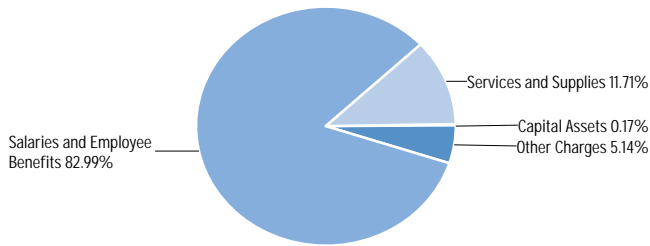

Source of Funds

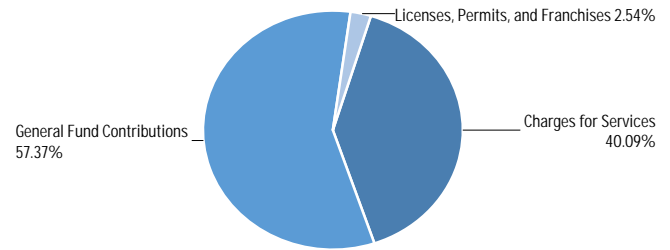

Use of Funds

Expenditures	Prior Year 2021-2022	Adopted Budget 2022-2023	CY Estimate 2022-2023	Requested Budget 2023-2024	Recommended Budget 2023-2024	Recommended Change from Adopted
Salaries and Employee Benefits	\$7,664,042	\$8,641,352	\$8,614,818	\$9,415,324	\$8,976,654	\$335,302
Services and Supplies	\$1,117,405	\$1,374,772	\$1,627,275	\$1,266,348	\$1,266,348	\$(108,424)
Other Charges	\$1,171,927	\$904,738	\$904,838	\$555,668	\$555,668	\$(349,070)
Capital Assets	\$34,212	\$110,000	\$60,000	\$18,000	\$18,000	\$(92,000)
Other Financing Uses	\$2,362,402	—	—	—	—	—
Subtotal	\$12,349,986	\$11,030,862	\$11,206,931	\$11,255,340	\$10,816,670	\$(214,192)

Source of Funds

Revenues	Prior Year 2021-2022	Adopted Budget 2022-2023	CY Estimate 2022-2023	Requested Budget 2023-2024	Recommended Budget 2023-2024	Recommended Change from Adopted
Licenses, Permits, and Franchises	\$198,421	\$225,000	\$200,000	\$275,000	\$275,000	\$50,000
Revenue from Use of Money & Property	\$5,453	—	—	—	—	—
Charges for Services	\$4,706,749	\$5,132,351	\$3,984,319	\$4,336,000	\$4,336,000	\$(796,351)
Miscellaneous Revenues	\$955	\$1,000	\$1,000	\$1,000	\$1,000	—
Other Financing Sources	\$2,362,402	—	—	—	—	—
Subtotal	\$7,273,980	\$5,358,351	\$4,185,319	\$4,612,000	\$4,612,000	\$(746,351)
General Fund Contributions	\$5,076,006	\$5,672,511	\$7,021,612	\$6,643,340	\$6,204,670	\$532,159
Total Source of Funds	\$12,349,986	\$11,030,862	\$11,206,931	\$11,255,340	\$10,816,670	\$(214,192)

Summary of Recommendation

The Recommended Budget for Assessor-County Clerk-Recorder is \$10,816,670 financed by \$4,612,000 in revenue and a general fund contribution (GFC) of \$6,204,670. The Recommended Budget reflects an increase of expenditures mainly due to negotiated salaries and worker's compensation premiums, and a revenue decrease of \$746,351 due to a decrease in recording fees; offset by a decrease in cost plan charges and decreases throughout various services and supplies such as the elimination of the Just Appraise software program. The Recommended Budget includes augmentations for four vital positions (Property Transfer Clerk, (2) Appraiser II, and Supervising Appraiser).

Fund 027 has been established to recognize and track restricted revenue solely for the use of the County Clerk/Recorder for office modernization, micrographics, vital records and electronic recording delivery system expenses; includes revenue of \$426,000 off-set by matching expenditures.

Budget Impacts

The decrease in recorded documents due to market conditions and ongoing interest rate changes has resulted in a loss of four critical positions for FY 2023-24, this is in addition to loss of positions in previous years. The impact includes: increased staff workloads due to processing of Proposition 19 claims; Proposition 8 review, updating of maps; review of exemptions and appeals requiring greater analysis; the contract cancellation of Just Appraise a software program which streamlined and provide more efficiency in processing and updating ownership from recorded documents; the postponement of redesigning and upgrading process of the County Clerk/Recorder lobby to provide an accommodating and efficient flow for customers; and the preservation project of old real property books and map record books in the Recorder's office. Even though there is currently a decrease in recorded documents, AB1466 mandated legislative changes has increased the workload in the Recorder's Office as it requires review of current and previously recorded documents to redact unlawfully restrictive covenant language from records in the Office of the County Recorder as per Section 12955(I) of the Government Code.

Prior Year Accomplishments

Completed the 2022 local assessment roll on time, with a net assessed value of over \$82.9 billion.

The Assessor's Office also reviewed the assessed valuation of over 5,400 properties with reduced values under the provisions of Proposition 8, Proposition 13 and Revenue and Tax Code Section 51.

Completed an Assessment Practices Survey by the State Board of Equalization in fulfillment of the provisions of section 15640-1546 of the Government Code.

Exceeded the goal and grew the percentage of electronically recorded documents by 80% in the Recorder's office.

Continued to provide quality customer service to all County taxpayers and to strive for continual improvement through placement of "How Are We Doing" survey cards at service counters. Survey cards are reviewed with management, office supervisors, and staff.

Developed a three- phase plan to identify and redact unlawfully restrictive covenant language from records in the Office of the County Recorder as per Section 12955(I) of the Government Code.

As of April 2023, Recorder's Office staff began Phase 1 to redact unlawfully restrictive covenant language from records of the County Recorder's office per 12955(I) of the Government Code.

Budget Year Goals

By June 30, 2024, produce a completed assessment roll of residential, commercial, and industrial properties in the County of Monterey for FY 2023-24.

Complete Phase 1: Redact unlawfully restrictive covenant language from 11,500 records in the Office of the County Recorder as per Section 12955(I) of the Government Code by end year 2023.

Continue preservation project of old real property books and map record books in the Recorder's Office.

Increase the level in ongoing efforts to digitize paper vital record certificates for FY 2023-24.

Begin the redesigning and upgrading process of the County Clerk/Recorder lobby to provide an accommodating and efficient flow for customers.

Continue to carry out, implement and monitor the Employee Engagement Action Plan to improve working relations and communication between management and employees.

Provide quality customer service to all taxpayers as evidence by maintaining a rating of 95% positive on customer survey cards.

Develop a comprehensive telework program.

Pending Issues

There are no pending issues.

Policy Considerations

There are no policy considerations.

Appropriation Expenditure Detail

	Prior Year 2021-2022	Adopted Budget 2022-2023	CY Estimate 2022-2023	Requested Budget 2023-2024	Recommended Budget 2023-2024	Recommended Change from Adopted	Fund Code	Budget Unit Code
Assessor (ACR001)	7,139,990	7,731,268	7,687,871	8,223,344	7,886,673	155,405	001	8003
Clerk/Recorder (ACR002)	4,927,174	2,899,594	2,810,241	2,605,996	2,503,997	(395,597)	001	8004
Clerk/Recorder (ACR003)	282,823	400,000	708,819	426,000	426,000	26,000	027	8004
Subtotal	\$12,349,986	\$11,030,862	\$11,206,931	\$11,255,340	\$10,816,670	\$(214,192)		

Budget Units

	Prior Year 2021-2022	Adopted Budget 2022-2023	CY Estimate 2022-2023	Requested Budget 2023-2024	Recommended Budget 2023-2024	Recommended Change from Adopted
Assessor	\$7,139,990	\$7,731,268	\$7,687,871	\$8,223,344	\$7,886,673	\$155,405
Clerk/Recorder	\$5,209,997	\$3,299,594	\$3,519,060	\$3,031,996	\$2,929,997	\$(369,597)
Subtotal	\$12,349,986	\$11,030,862	\$11,206,931	\$11,255,340	\$10,816,670	\$(214,192)

Adopted FY 2022-23 to Recommended FY 2023-24 Positions

Classification Code	Classification Label	Adopted Budget 2021-2022	Adopted Budget 2022-2023	Recommended Budget 2023-2024	Change
11B01	ASSESSOR-COUNTY CLERK-RECORDER	1.00	1.00	1.00	0.00
12A05	ASSISTANT COUNTY CLERK-RECORDER	1.00	1.00	1.00	0.00
12A15	ASSISTANT ASSESSOR-VALUATION	1.00	1.00	1.00	0.00
14B32	SENIOR PERSONNEL ANALYST	1.00	1.00	1.00	0.00
14C71	ADMINISTRATIVE SERVICES OFFICER	1.00	1.00	1.00	0.00

Adopted FY 2022-23 to Recommended FY 2023-24 Positions

Classification Code	Classification Label	Adopted Budget 2021-2022	Adopted Budget 2022-2023	Recommended Budget 2023-2024	Change
14G02	MANAGEMENT ANALYST I	1.00	1.00	1.00	0.00
14H03	PERSONNEL TECHNICIAN-CONFIDENTIAL	1.00	1.00	1.00	0.00
14K45	AUDITOR APPRAISER MANAGER	1.00	1.00	1.00	0.00
16C87	BUSINESS TECHNOLOGY ANALYST II	1.00	1.00	1.00	0.00
16F40	DEPARTMENTAL INFORMATION SYSTEMS MANAGER I	1.00	1.00	1.00	0.00
16F41	DEPARTMENTAL INFORMATION SYSTEMS MANAGER II	1.00	1.00	1.00	0.00
20B10	ACCOUNTANT I	1.00	1.00	1.00	0.00
20B95	FINANCE MANAGER I	1.00	1.00	1.00	0.00
28A21	APPRAISER II	13.00	13.00	13.00	0.00
28A22	APPRAISER III	5.00	5.00	5.00	0.00
28A80	SUPERVISING APPRAISER	2.00	2.00	2.00	0.00
28B21	AUDITOR-APPRAISER II	4.00	4.00	4.00	0.00
28B22	AUDITOR-APPRAISER III	1.00	1.00	1.00	0.00
43F21	MAP DRAFTING TECHNICIAN	1.00	1.00	0.00	(1.00)
43F80	SENIOR MAP DRAFTING TECHNICIAN	1.00	1.00	1.00	0.00
80A99	ADMINISTRATIVE SECRETARY-CONFIDENTIAL	1.00	1.00	1.00	0.00
80E21	OFFICE ASSISTANT II	7.00	7.00	7.00	0.00
80E22	OFFICE ASSISTANT III	6.00	6.00	5.00	(1.00)
80E80	PRINCIPAL OFFICE ASSISTANT	1.00	1.00	1.00	0.00
80E81	SUPERVISING OFFICE ASSISTANT I	2.00	2.00	2.00	0.00
80E82	SUPERVISING OFFICE ASSISTANT II	1.00	1.00	1.00	0.00
80E92	RECORDER SERVICES SUPERVISOR	1.00	1.00	1.00	0.00
80J22	SENIOR ACCOUNT CLERK	1.00	1.00	1.00	0.00
80J30	ACCOUNTING TECHNICIAN	1.00	1.00	1.00	0.00
80P22	PHOTOCOPIST	2.00	2.00	2.00	0.00
80R11	ASSESSMENT CLERK	1.00	1.00	0.00	(1.00)
80R22	PROPERTY TRANSFER CLERK	4.00	4.00	3.00	(1.00)
80R23	SENIOR PROPERTY TRANSFER CLERK	1.00	1.00	1.00	0.00
Total		69.00	69.00	65.00	(4.00)

Augmentation Requests

Request Code	Request Name	Ranking Type Name	Requested Amount	Requested FTE	Recommended Budget	Recommended FTE
1180-8003-001-AUG1	SQ Vacant Property Transfer Clerk	Status Quo Vacant Position	90,012	1.00	-	-
1180-8003-001-AUG3	SQ Vacant Appraiser II	Status Quo Vacant Position	139,219	1.00	127,617	1.00
1180-8003-001-AUG4	SQ Vacant Appraiser II	Status Quo Vacant Position	139,219	1.00	127,617	1.00
1180-8003-001-AUG5	SQ Vacant Supervising Appraiser	Status Quo Vacant Position	184,544	1.00	169,165	1.00
1180-8003-001-AUG6	SQ Vacant Auditor Appraiser II	Status Quo Vacant Position	131,737	1.00	120,759	1.00
1180-8003-001-AUG7	SQ Vacant Map Drafting Tech	Status Quo Vacant Position	105,425	1.00	-	-
1180-8003-001-AUG8	SQ Vacant Assessment Clerkor Appraiser II	Status Quo Vacant Position	91,673	1.00	-	-
1180-8004-001-AUG2	Status Quo Vacant OAI	Status Quo Vacant Position	101,999	1.00	-	-
Grand Total:			\$983,828	8.00	\$545,159	4.00

Assessor-County Clerk-Recorder

Assessor

(Budget Unit 8003—Fund 001—Appropriation Unit ACR001)

Use of Funds

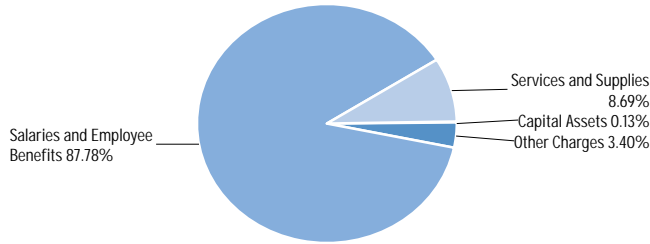

Source of Funds

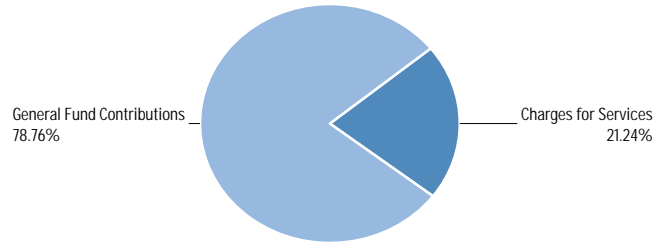

Use of Funds

Expenditures	Prior Year 2021-2022	Adopted Budget 2022-2023	CY Estimate 2022-2023	Requested Budget 2023-2024	Recommended Budget 2023-2024	Recommended Change from Adopted
Salaries and Employee Benefits	\$5,819,480	\$6,575,003	\$6,544,299	\$7,259,767	\$6,923,096	\$348,093
Services and Supplies	\$663,974	\$724,322	\$711,529	\$685,421	\$685,421	\$(38,901)
Other Charges	\$638,756	\$421,943	\$422,043	\$268,156	\$268,156	\$(153,787)
Capital Assets	\$17,780	\$10,000	\$10,000	\$10,000	\$10,000	—
Subtotal	\$7,139,990	\$7,731,268	\$7,687,871	\$8,223,344	\$7,886,673	\$155,405

Source of Funds

Revenues	Prior Year 2021-2022	Adopted Budget 2022-2023	CY Estimate 2022-2023	Requested Budget 2023-2024	Recommended Budget 2023-2024	Recommended Change from Adopted
Charges for Services	\$1,424,044	\$1,575,000	\$1,550,000	\$1,675,000	\$1,675,000	\$100,000
Subtotal	\$1,424,044	\$1,575,000	\$1,550,000	\$1,675,000	\$1,675,000	\$100,000
General Fund Contributions	\$5,715,945	\$6,156,268	\$6,137,871	\$6,548,344	\$6,211,673	\$55,405
Total Source of Funds	\$7,139,990	\$7,731,268	\$7,687,871	\$8,223,344	\$7,886,673	\$155,405

Unit Description

The Assessor is an elected County official whose responsibilities include: locating all taxable property in the County and determining property ownership; establishing the taxable value of all property subject to local property taxation; applying all legal exemptions; and preparing annual assessment rolls upon which local government units rely for property tax revenue. To accomplish these various tasks, the Assessor has organized the office into the following program areas: Administration, Department Information Systems and Map Drafting, Exemptions, Personal Property Appraisal, Real Property Appraisal, and Change of Ownership. Tax revenues identified by the Assessor's Office valuation of property account for approximately two-thirds of the County's discretionary funds.

Recommended FY 2023-24 Positions

Classification Code	Classification Label	FTE
11B01	ASSESSOR-COUNTY CLERK-RECORDER	1.00
12A15	ASSISTANT ASSESSOR-VALUATION	1.00
14B32	SENIOR PERSONNEL ANALYST	1.00
14C71	ADMINISTRATIVE SERVICES OFFICER	1.00
14H03	PERSONNEL TECHNICIAN- CONFIDENTIAL	1.00
14K45	AUDITOR APPRAISER MANAGER	1.00
16C87	BUSINESS TECHNOLOGY ANALYST II	1.00
16F41	DEPARTMENTAL INFORMATION SYSTEMS MANAGER II	1.00
28A21	APPRAISER II	13.00
28A22	APPRAISER III	5.00
28A80	SUPERVISING APPRAISER	2.00
28B21	AUDITOR-APPRAISER II	4.00
28B22	AUDITOR-APPRAISER III	1.00
43F80	SENIOR MAP DRAFTING TECHNICIAN	1.00

Recommended FY 2023-24 Positions

Classification Code	Classification Label	FTE
80A99	ADMINISTRATIVE SECRETARY- CONFIDENTIAL	1.00
80E21	OFFICE ASSISTANT II	5.00
80E80	PRINCIPAL OFFICE ASSISTANT	1.00
80E81	SUPERVISING OFFICE ASSISTANT I	2.00
80J22	SENIOR ACCOUNT CLERK	1.00
80J30	ACCOUNTING TECHNICIAN	1.00
80R22	PROPERTY TRANSFER CLERK	3.00
80R23	SENIOR PROPERTY TRANSFER CLERK	1.00
Total		49.00

Clerk/Recorder

(Budget Unit 8004—Fund 001—Appropriation Unit ACR002)

Use of Funds

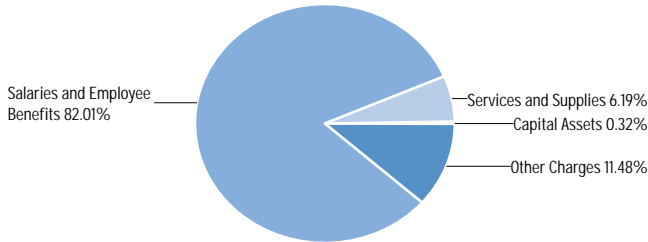

Source of Funds

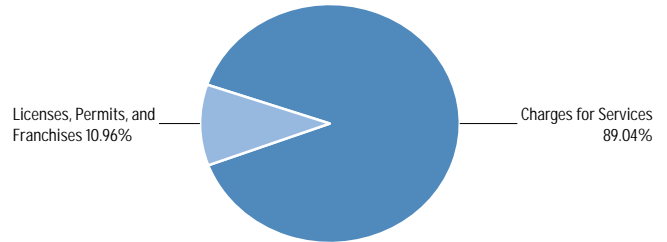

Use of Funds

Expenditures	Prior Year 2021-2022	Adopted Budget 2022-2023	CY Estimate 2022-2023	Requested Budget 2023-2024	Recommended Budget 2023-2024	Recommended Change from Adopted
Salaries and Employee Benefits	\$1,844,561	\$2,066,349	\$2,070,519	\$2,155,557	\$2,053,558	\$(12,791)
Services and Supplies	\$170,607	\$250,450	\$206,927	\$154,927	\$154,927	\$(95,523)
Other Charges	\$533,171	\$482,795	\$482,795	\$287,512	\$287,512	\$(195,283)
Capital Assets	\$16,432	\$100,000	\$50,000	\$8,000	\$8,000	\$(92,000)
Other Financing Uses	\$2,362,402	—	—	—	—	—
Subtotal	\$4,927,174	\$2,899,594	\$2,810,241	\$2,605,996	\$2,503,997	\$(395,597)

Source of Funds

Revenues	Prior Year 2021-2022	Adopted Budget 2022-2023	CY Estimate 2022-2023	Requested Budget 2023-2024	Recommended Budget 2023-2024	Recommended Change from Adopted
Licenses, Permits, and Franchises	\$198,421	\$225,000	\$200,000	\$275,000	\$275,000	\$50,000
Charges for Services	\$2,650,664	\$3,157,351	\$1,725,500	\$2,235,000	\$2,235,000	\$(922,351)
Miscellaneous Revenues	\$955	\$1,000	\$1,000	\$1,000	\$1,000	—
Subtotal	\$2,850,040	\$3,383,351	\$1,926,500	\$2,511,000	\$2,511,000	\$(872,351)
General Fund Contributions	\$2,077,133	\$(483,757)	\$883,741	\$94,996	\$(7,003)	\$476,754
Total Source of Funds	\$4,927,174	\$2,899,594	\$2,810,241	\$2,605,996	\$2,503,997	\$(395,597)

Unit Description

The County Clerk-Recorder creates, maintains, and has custody of files which constitute the official public record of certain legal/financial documents such as deeds, notices of default, notices of completion, abstracts of judgment, liens, subdivision maps, etc. These files are of importance to the conduct of local commerce and are vital to the real estate industry. The County Clerk-Recorder's functions also include, but are not limited to: maintaining records of births, deaths and certain marriages; certification of copies of public records; and issuance of marriage licenses.

Recommended FY 2023-24 Positions

Classification Code	Classification Label	FTE
12A05	ASSISTANT COUNTY CLERK-RECORDER	1.00
14G02	MANAGEMENT ANALYST I	1.00
16F40	DEPARTMENTAL INFORMATION SYSTEMS MANAGER I	1.00
20B10	ACCOUNTANT I	1.00
20B95	FINANCE MANAGER I	1.00
80E21	OFFICE ASSISTANT II	2.00
80E22	OFFICE ASSISTANT III	5.00
80E82	SUPERVISING OFFICE ASSISTANT II	1.00
80E92	RECORDER SERVICES SUPERVISOR	1.00
80P22	PHOTOCOPYIST	2.00
Total		16.00

Clerk/Recorder

(Budget Unit 8004—Fund 027—Appropriation Unit ACR003)

Use of Funds

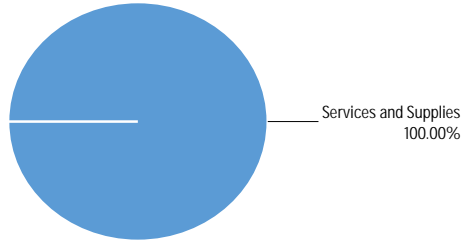

Source of Funds

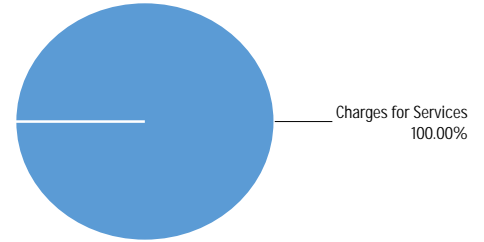

Use of Funds

Expenditures	Prior Year 2021-2022	Adopted Budget 2022-2023	CY Estimate 2022-2023	Requested Budget 2023-2024	Recommended Budget 2023-2024	Recommended Change from Adopted
Services and Supplies	\$282,823	\$400,000	\$708,819	\$426,000	\$426,000	\$26,000
Subtotal	\$282,823	\$400,000	\$708,819	\$426,000	\$426,000	\$26,000

Source of Funds

Revenues	Prior Year 2021-2022	Adopted Budget 2022-2023	CY Estimate 2022-2023	Requested Budget 2023-2024	Recommended Budget 2023-2024	Recommended Change from Adopted
Revenue from Use of Money & Property	\$5,453	—	—	—	—	—
Charges for Services	\$632,041	\$400,000	\$708,819	\$426,000	\$426,000	\$26,000
Other Financing Sources	\$2,362,402	—	—	—	—	—
Subtotal	\$2,999,895	\$400,000	\$708,819	\$426,000	\$426,000	\$26,000
Fund Balance	\$(2,717,072)	—	—	—	—	—
Total Source of Funds	\$282,823	\$400,000	\$708,819	\$426,000	\$426,000	\$26,000

Unit Description

Beginning FY 2019-20, Fund 027 was established to serve as the repository and appropriation unit for the County Clerk/Recorder's restricted revenue. In accordance with GASB 33, restricted recording fee revenue must be recognized and tracked. These funds are restricted by law under GC 27361.4 (a), GC 27361 (c), GC 27397,

and H&S 103625 (h) solely for the use of the County Clerk/Recorder's Office for modernization, micrographics, vital record, and electronic recording delivery system expenses. The Recommended Budget for FY 2023-24, in the amount of \$426,000, represents the estimated funding available to fund eligible expenditures during the budget year.



This page intentionally left blank.

County Counsel

Departmental Overview:

The Office of the County Counsel serves as the in-house legal counsel for the County of Monterey, the Board of Supervisors (BOS), and all County officers, departments, agencies, boards, and commissions, as well as liaison and support to the Civil Grand Jury. In addition to providing legal advice, the Office also represents the County in civil and special litigation in State and federal courts, various administrative proceedings, and coordinates the services of outside legal counsel.

Programs and Functions:

The County Counsel's Office consists of four divisions. The General Government, Litigation and Land Use Divisions provide legal counsel to County departments, and representation in litigation matters. The Risk Management Division is responsible for the oversight and management of all County insurance and self-insurance programs, claims management, safety, ergonomics, and other risk transfer and loss control activities that protect the County and mitigate losses. The Office manages and advises the Monterey County Civil Grand Jury and provides legal and insurance related services for the Water Resource Agency.

Department's Contribution to Monterey County's Strategic Initiatives:

The Office of County Counsel addresses each of the Strategic Initiative Policy Areas: Economic Development, Administration, Health & Human Services, Infrastructure and Public Safety. The primary goal of the Office of the County Counsel is providing services with the highest degree of competence and integrity in a timely and responsive manner in order to enable the Board of Supervisors, County officials and departments, and outside agencies to effectively carry out their functions and achieve their goals.



Operating Budget: \$50,898,799
Positions (FTEs): 54.00

Les J. Girard
County Council

County Council

Risk Management

County Council Non-Departmental

Staffing Trends

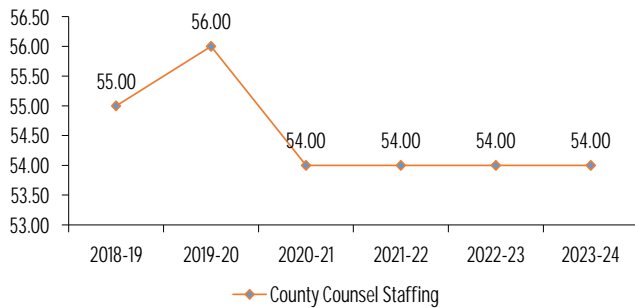

Expenditure/Revenue History (in millions)

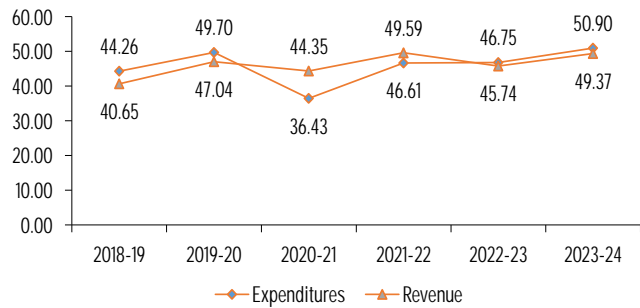

Legal advisor and primary litigator for the Board of Supervisors, elected County officials, and all County departments and agencies on issues of law or public policy. County Counsel also advises various boards, special districts and commissions operating within the County. In doing so, County Counsel enables its clients to carry out their responsibilities in a manner fully consistent with the law. The Risk Division manages general liability and workers' compensation programs, safety, ergonomics, and procures insurance.

Key Performance Measures	2020-21 Actual	2021-22 Actual	2022-23 Mid-Year
Number of litigation matters opened/pending.	144	108	118
Number of liability claims opened/pending.	110	124	52
Number of new and returning assignments and percentage of completion within a cycle of two weeks.	3,687 74%	4,403 71%	1,301 46%
Number of workers' compensation claims open or pending status.	908	981	1,024
Annual average workers' compensation costs per new claim.	\$15,554	\$15,985	\$14,366

Use of Funds

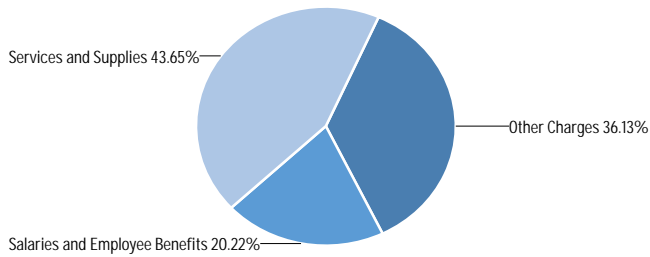

Source of Funds

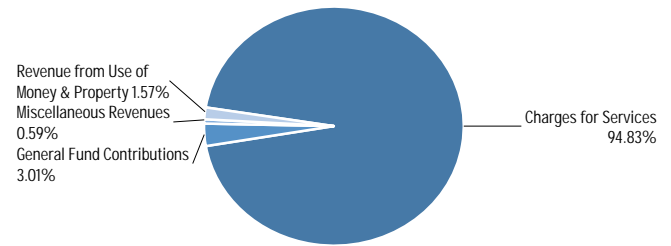

Use of Funds

Expenditures	Prior Year 2021-2022	Adopted Budget 2022-2023	CY Estimate 2022-2023	Requested Budget 2023-2024	Recommended Budget 2023-2024	Recommended Change from Adopted
Salaries and Employee Benefits	\$8,615,315	\$10,207,390	\$9,536,512	\$10,290,650	\$10,290,650	\$83,260
Services and Supplies	\$16,060,983	\$19,832,543	\$17,164,377	\$22,218,145	\$22,218,145	\$2,385,602
Other Charges	\$21,936,669	\$19,570,798	\$20,051,309	\$18,390,004	\$18,390,004	\$(1,180,794)
Subtotal	\$46,612,966	\$49,610,731	\$46,752,198	\$50,898,799	\$50,898,799	\$1,288,068

Source of Funds

Revenues	Prior Year 2021-2022	Adopted Budget 2022-2023	CY Estimate 2022-2023	Requested Budget 2023-2024	Recommended Budget 2023-2024	Recommended Change from Adopted
Fines, Forfeitures, and Penalties	\$1,695	—	—	—	—	—
Revenue from Use of Money & Property	\$585,519	\$817,857	\$817,857	\$800,000	\$800,000	\$(17,857)
Charges for Services	\$45,528,097	\$47,133,754	\$44,121,515	\$48,265,788	\$48,265,788	\$1,132,034
Miscellaneous Revenues	\$3,476,657	\$300,000	\$798,448	\$300,000	\$300,000	—
Subtotal	\$49,591,968	\$48,251,611	\$45,737,820	\$49,365,788	\$49,365,788	\$1,114,177
Fund Balance	\$(4,954,314)	—	—	—	—	—
General Fund Contributions	\$1,975,313	\$1,359,120	\$1,014,378	\$1,533,011	\$1,533,011	\$173,891
Total Source of Funds	\$46,612,966	\$49,610,731	\$46,752,198	\$50,898,799	\$50,898,799	\$1,288,068

Summary of Recommendation

The Fiscal Year (FY) 2023-24 Recommended Budget for the Office of the County Counsel is \$50,898,799 in appropriations with total expenditures of \$59,184,432, financed by \$49,365,788 in estimated revenue, \$3,790,280 cost plan credit, \$4,495,353 in interfund reimbursements, and a general fund contribution (GFC) of \$1,533,011. Expenditures in the Recommended Budget grew by \$1,288,068 mainly due to increases in negotiated salaries, pension plans, health insurance, excess insurance, and property insurance. Expenditures were offset by a decrease in claims and judgment costs. Revenue is estimated to increase by \$1,114,177 as General Liability (GL) and Worker' Compensation (WC) cost allocations increase with cost.

Budget Impacts

No impact.

Prior Year Accomplishments

Responded to the majority of legal requests within fifteen (15) days of receipt. Many matters are not returned within fifteen days because they are ongoing and/or complex.

Responded to or completed claims within 30 days, using a committee including the general liability carrier which meets every two weeks to discuss and make decisions.

County Counsel deputies and staff completed required State Bar trainings and/or the County mandatory trainings. Completion of mandatory training deadlines are tracked.

Budget Year Goals

Respond to legal requests within fifteen (15) days of receipt to assist elected officials, County offices and departments in achieving their goals and objectives.

Manage and conclude claims and litigation in a fair manner, which respects both the rights of claimants and litigants and provides fiscal accountability to the public.

Maintain the professional and technical competence of all employees through appropriate continuing education, modern technology, and electronic case management and assignment tools, in order to provide innovative solutions to legal problems.

Pending Issues

Testing and bioventing of the water at Lake San Antonio resulting from a fuel system leak. The Department may have to request additional funding during FY 2023-24 should the bioventing not prove effective.

Policy Considerations

As per the State Controller's office and the County's own Actuarial Service provider (Bickmore), the County's GL and WC Internal Service Funds (ISF) should be operating at an 80% confidence level after 10 years. The County programs have remained at 70% over the last 19 years.

Appropriation Expenditure Detail

	Prior Year 2021-2022	Adopted Budget 2022-2023	CY Estimate 2022-2023	Requested Budget 2023-2024	Recommended Budget 2023-2024	Recommended Change from Adopted	Fund Code	Budget Unit Code
Legal Division (COU001)	1,885,434	1,209,263	1,077,381	1,558,167	1,558,167	348,904	001	8057
Grand Jury (COU005)	439,068	342,952	334,582	324,844	324,844	(18,108)	001	8405
General Liability (COU003)	15,009,286	21,666,611	20,999,051	22,465,788	22,465,788	799,177	475	8408
Workers Compensation (COU004)	29,134,092	26,185,000	24,329,875	26,500,000	26,500,000	315,000	476	8409
Enterprise Risk (COU006)	145,086	206,905	11,309	50,000	50,000	(156,905)	001	8429
Subtotal	\$46,612,966	\$49,610,731	\$46,752,198	\$50,898,799	\$50,898,799	\$1,288,068		

Budget Units

	Prior Year 2021-2022	Adopted Budget 2022-2023	CY Estimate 2022-2023	Requested Budget 2023-2024	Recommended Budget 2023-2024	Recommended Change from Adopted
Legal Division	\$1,885,434	\$1,209,263	\$1,077,381	\$1,558,167	\$1,558,167	\$348,904
Grand Jury	\$439,068	\$342,952	\$334,582	\$324,844	\$324,844	\$(18,108)
Risk Management Division	—	—	—	—	—	—
General Liability	\$15,009,286	\$21,666,611	\$20,999,051	\$22,465,788	\$22,465,788	\$799,177
Workers Compensation	\$29,134,092	\$26,185,000	\$24,329,875	\$26,500,000	\$26,500,000	\$315,000
Enterprise Risk	\$145,086	\$206,905	\$11,309	\$50,000	\$50,000	\$(156,905)
Subtotal	\$46,612,966	\$49,610,731	\$46,752,198	\$50,898,799	\$50,898,799	\$1,288,068

Adopted FY 2022-23 to Recommended FY 2023-24 Positions

Classification Code	Classification Label	Adopted Budget 2021-2022	Adopted Budget 2022-2023	Recommended Budget 2023-2024	Change
11A04	COUNTY COUNSEL	1.00	1.00	1.00	0.00
12C38	ASSISTANT COUNTY COUNSEL	1.00	2.00	2.00	0.00
12C39	CHIEF ASSISTANT COUNTY COUNSEL	1.00	1.00	1.00	0.00
14B62	ASSOCIATE RISK & BENEFITS ANALYST	1.00	1.00	1.00	0.00
14B63	SENIOR RISK & BENEFITS ANALYST	1.00	1.00	1.00	0.00
14B64	PRINCIPAL RISK & BENEFITS ANALYST	1.00	1.00	1.00	0.00
14C30	MANAGEMENT ANALYST II	1.00	1.00	1.00	0.00
14C31	MANAGEMENT ANALYST III	2.00	2.00	2.00	0.00
14C32	SAFETY OFFICER	1.00	1.00	1.00	0.00
14C85	WORKERS COMPENSATION MANAGER	1.00	1.00	1.00	0.00
14C86	ERGONOMICS MANAGER	1.00	1.00	1.00	0.00
14N05	ADMINISTRATIVE OPERATIONS MANAGER	0.00	0.00	1.00	1.00
20B93	FINANCE MANAGER II	0.00	0.00	1.00	1.00
20B95	FINANCE MANAGER I	1.00	1.00	0.00	(1.00)
39B23	DEPUTY COUNTY COUNSEL IV	15.00	15.00	14.00	(1.00)
39B25	CHIEF DEPUTY COUNTY COUNSEL	4.00	3.00	3.00	0.00
74K50	SAFETY COORDINATOR/INVESTIGATOR	3.00	3.00	3.00	0.00

Adopted FY 2022-23 to Recommended FY 2023-24 Positions

Classification Code	Classification Label	Adopted Budget 2021-2022	Adopted Budget 2022-2023	Recommended Budget 2023-2024	Change
80A34	SENIOR SECRETARY-CONFIDENTIAL	1.00	1.00	1.00	0.00
80A99	ADMINISTRATIVE SECRETARY-CONFIDENTIAL	1.00	1.00	1.00	0.00
80B26	LEGAL SECRETARY III	7.00	7.00	7.00	0.00
99ZWC	ALLOCATION ON LOAN WORK COMP	10.00	10.00	10.00	0.00
Total		54.00	54.00	54.00	0.00

County Counsel Departmental

Use of Funds

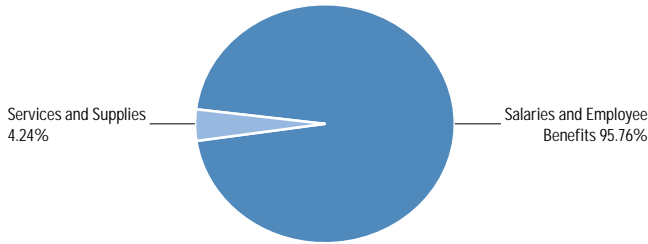

Source of Funds

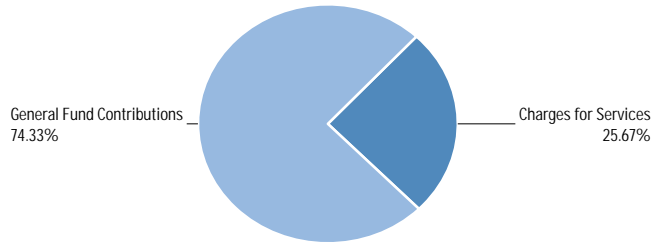

Use of Funds

Expenditures	Prior Year 2021-2022	Adopted Budget 2022-2023	CY Estimate 2022-2023	Requested Budget 2023-2024	Recommended Budget 2023-2024	Recommended Change from Adopted
Salaries and Employee Benefits	\$8,526,490	\$10,116,277	\$9,450,235	\$10,202,994	\$10,202,994	\$86,717
Services and Supplies	\$355,993	\$416,854	\$402,811	\$451,216	\$451,216	\$34,362
Other Charges	\$(6,997,049)	\$(9,323,868)	\$(8,775,665)	\$(9,096,043)	\$(9,096,043)	\$227,825
Subtotal	\$1,885,434	\$1,209,263	\$1,077,381	\$1,558,167	\$1,558,167	\$348,904

Source of Funds

Revenues	Prior Year 2021-2022	Adopted Budget 2022-2023	CY Estimate 2022-2023	Requested Budget 2023-2024	Recommended Budget 2023-2024	Recommended Change from Adopted
Charges for Services	\$494,275	\$400,000	\$408,396	\$400,000	\$400,000	—
Miscellaneous Revenues	—	—	\$498	—	—	—
Subtotal	\$494,275	\$400,000	\$408,894	\$400,000	\$400,000	—
General Fund Contributions	\$1,391,159	\$809,263	\$668,487	\$1,158,167	\$1,158,167	\$348,904
Total Source of Funds	\$1,885,434	\$1,209,263	\$1,077,381	\$1,558,167	\$1,558,167	\$348,904

Division Description

The County Counsel Departmental section includes the Office of the County Counsel and Risk Management.

The Office of the County Counsel serves as the in-house legal counsel for the County of Monterey, the Board of Supervisors, and all County officers, departments, agencies, boards, and commissions. In addition to administrative and support staff, the Departmental section consists of three divisions - Land Use, Litigation, and General Government, and oversees the Risk Management Division and provides support to the Grand Jury.

Risk Management oversees insurance, self-insurance, claims management, Workers Compensation (WC), General Liability (GL), safety, ergonomics, and other risk transfer and loss control activities that protect the County and mitigate losses. Additional responsibilities include administration of the general insurance programs such as fire,

earthquake, property, boiler/machinery, and performance bonds. Risk Management, with assistance of County Counsel, negotiates and places excess insurance and manages and directs GL and WC claims and medical malpractice claims involving the Health Department and Natividad Medical Center (NMC).

Summary of Recommendation

The Fiscal Year (FY) 2023-24 Recommended Budget for County Counsel Departmental is \$1,158,167 in appropriations with total expenditures of \$10,654,210, financed by \$400,000 in estimated revenue, \$4,600,690 cost plan, \$4,495,353 interfund reimbursements and GFC of \$1,158,167. The \$348,904 increase in expenditures is due to negotiated salaries, pension plans, health insurance, and internal record retention charges. The Recommended Budget includes \$2,372,449 in expenditures for Risk Management, offset by reimbursements from the GL and WC Internal Service Funds (ISFs).

Appropriation Expenditure Detail

	Prior Year 2021-2022	Adopted Budget 2022-2023	CY Estimate 2022-2023	Requested Budget 2023-2024	Recommended Budget 2023-2024	Recommended Change from Adopted	Fund Code	Budget Unit Code
Legal Division (COU001)	1,885,434	1,209,263	1,077,381	1,558,167	1,558,167	348,904	001	8057
Risk Management Div (COU002)	0	0	0	0	0	0	001	8407
Subtotal	\$1,885,434	\$1,209,263	\$1,077,381	\$1,558,167	\$1,558,167	\$348,904		

Legal Division

(Budget Unit 8057—Fund 001—Appropriation Unit COU001)

Use of Funds

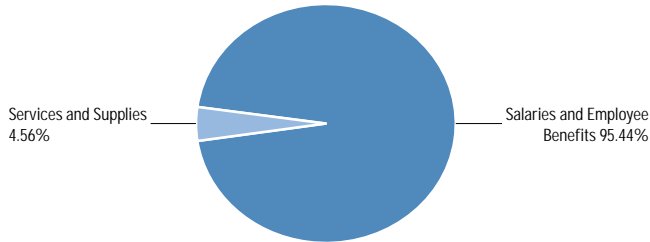

Source of Funds

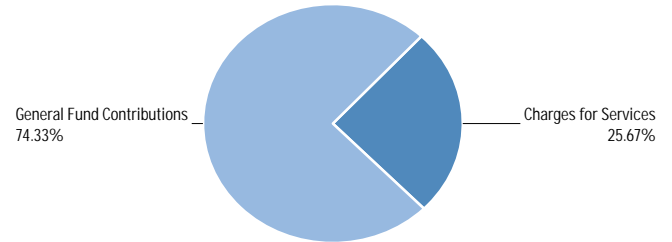

Use of Funds

Expenditures	Prior Year 2021-2022	Adopted Budget 2022-2023	CY Estimate 2022-2023	Requested Budget 2023-2024	Recommended Budget 2023-2024	Recommended Change from Adopted
Salaries and Employee Benefits	\$6,745,387	\$7,913,739	\$7,455,510	\$7,904,129	\$7,904,129	\$(9,610)
Services and Supplies	\$294,684	\$352,250	\$338,156	\$377,632	\$377,632	\$25,382
Other Charges	\$(5,154,638)	\$(7,056,726)	\$(6,716,285)	\$(6,723,594)	\$(6,723,594)	\$333,132
Subtotal	\$1,885,434	\$1,209,263	\$1,077,381	\$1,558,167	\$1,558,167	\$348,904

Source of Funds

Revenues	Prior Year 2021-2022	Adopted Budget 2022-2023	CY Estimate 2022-2023	Requested Budget 2023-2024	Recommended Budget 2023-2024	Recommended Change from Adopted
Charges for Services	\$494,275	\$400,000	\$408,396	\$400,000	\$400,000	—
Miscellaneous Revenues	—	—	\$498	—	—	—
Subtotal	\$494,275	\$400,000	\$408,894	\$400,000	\$400,000	—
General Fund Contributions	\$1,391,159	\$809,263	\$668,487	\$1,158,167	\$1,158,167	\$348,904
Total Source of Funds	\$1,885,434	\$1,209,263	\$1,077,381	\$1,558,167	\$1,558,167	\$348,904

Unit Description

The Office of the County Counsel serves as the in-house legal counsel for the County of Monterey, the Board of Supervisors, and all County officers, departments, agencies, boards, and commissions. The Office represents the County in civil and special litigation in State and federal courts, various administrative proceedings, and coordinates the services of outside legal counsel. Divisions within the Office include: Administration and Support (comprised of business, legal and office support staff); Land Use, Litigation and Employment; General Government; and Risk Management.

The Office also provides legal services, by contract or statute, to other public entities, including the Transportation Agency of Monterey County, Local Agency Formation Commission, Water Resources Agency, the Monterey Bay Unified Air Pollution Control District, and the Salinas Valley Basin Groundwater Sustainability Agency. Also, the Office serves as legal counsel to the Civil Grand Jury and special districts whose governing boards are composed, in whole or in part, by persons appointed by the Board of Supervisors.

Recommended FY 2023-24 Positions

Classification Code	Classification Label	FTE
11A04	COUNTY COUNSEL	1.00
12C38	ASSISTANT COUNTY COUNSEL	2.00
12C39	CHIEF ASSISTANT COUNTY COUNSEL	1.00
14C30	MANAGEMENT ANALYST II	1.00
14C31	MANAGEMENT ANALYST III	1.00
14N05	ADMINISTRATIVE OPERATIONS MANAGER	1.00
39B23	DEPUTY COUNTY COUNSEL IV	14.00
39B25	CHIEF DEPUTY COUNTY COUNSEL	3.00
80A99	ADMINISTRATIVE SECRETARY-CONFIDENTIAL	1.00
80B26	LEGAL SECRETARY III	7.00
Total		32.00

Risk Management Division

(Budget Unit 8407—Fund 001—Appropriation Unit COU002)

Use of Funds

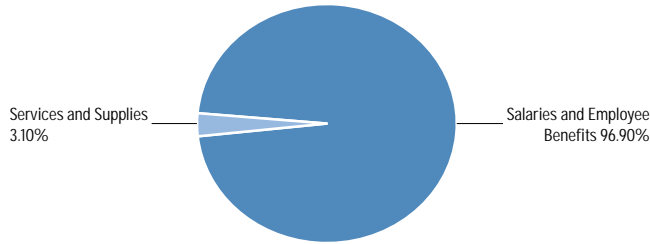

Source of Funds

Intentionally Left Blank

Use of Funds

Expenditures	Prior Year 2021-2022	Adopted Budget 2022-2023	CY Estimate 2022-2023	Requested Budget 2023-2024	Recommended Budget 2023-2024	Recommended Change from Adopted
Salaries and Employee Benefits	\$1,781,102	\$2,202,538	\$1,994,725	\$2,298,865	\$2,298,865	\$96,327
Services and Supplies	\$61,309	\$64,604	\$64,655	\$73,584	\$73,584	\$8,980
Other Charges	\$(1,842,411)	\$(2,267,142)	\$(2,059,380)	\$(2,372,449)	\$(2,372,449)	\$(105,307)

Source of Funds

Revenues	Prior Year 2021-2022	Adopted Budget 2022-2023	CY Estimate 2022-2023	Requested Budget 2023-2024	Recommended Budget 2023-2024	Recommended Change from Adopted
General Fund Contributions	-	-	-	-	-	-
Total Source of Funds	-	-	-	-	-	-

Unit Description

Risk Management oversees and manages County insurance programs, claims management, safety, ergonomics, contract risk review, and other risk transfer and loss control activities that protect the County and mitigate losses. Responsibilities of this Division include: management, oversight, and administration of safety programs; Worker Compensation (WC) insurance and self-insurance; General Liability (GL) insurance; healthcare liability and medical malpractice insurance; and directors' and officers' liability coverage. Additional responsibilities include administration of the general insurance programs such as fire, earthquake, property, boiler/machinery, and performance bonds. Risk Management also negotiates and places excess insurance and manages and directs GL and WC claims and medical malpractice claims involving the Health Department and Natividad Medical Center (NMC).

Recommended FY 2023-24 Positions

Classification Code	Classification Label	FTE
14B62	ASSOCIATE RISK & BENEFITS ANALYST	1.00
14B63	SENIOR RISK & BENEFITS ANALYST	1.00
14B64	PRINCIPAL RISK MANAGEMENT ANALYST	1.00
14C31	MANAGEMENT ANALYST III	1.00
14C32	SAFETY OFFICER	1.00
14C85	WORKERS COMPENSATION MANAGER	1.00
14C86	ERGONOMICS MANAGER	1.00
20B93	FINANCE MANAGER II	1.00
74K50	SAFETY COORDINATOR/ INVESTIGATOR	3.00
80A34	SENIOR SECRETARY-CONFIDENTIAL	1.00
99ZWC	ALLOCATION ON LOAN WORK COMP	10.00
Total		22.00

County Counsel Non-Departmental

Use of Funds

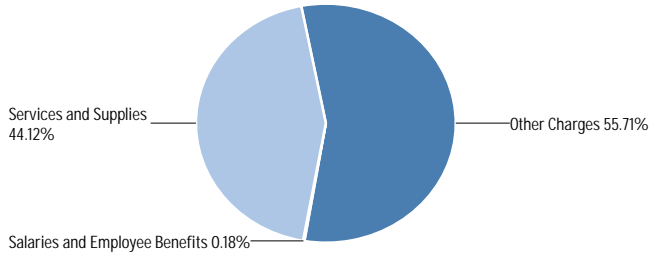

Source of Funds

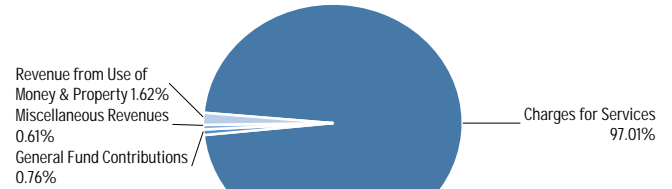

Use of Funds

Expenditures	Prior Year 2021-2022	Adopted Budget 2022-2023	CY Estimate 2022-2023	Requested Budget 2023-2024	Recommended Budget 2023-2024	Recommended Change from Adopted
Salaries and Employee Benefits	\$88,825	\$91,113	\$86,277	\$87,656	\$87,656	\$(3,457)
Services and Supplies	\$15,704,989	\$19,415,689	\$16,761,566	\$21,766,929	\$21,766,929	\$2,351,240
Other Charges	\$28,933,718	\$28,894,666	\$28,826,974	\$27,486,047	\$27,486,047	\$(1,408,619)
Subtotal	\$44,727,532	\$48,401,468	\$45,674,817	\$49,340,632	\$49,340,632	\$939,164

Source of Funds

Revenues	Prior Year 2021-2022	Adopted Budget 2022-2023	CY Estimate 2022-2023	Requested Budget 2023-2024	Recommended Budget 2023-2024	Recommended Change from Adopted
Fines, Forfeitures, and Penalties	\$1,695	—	—	—	—	—
Revenue from Use of Money & Property	\$585,519	\$817,857	\$817,857	\$800,000	\$800,000	\$(17,857)
Charges for Services	\$45,033,822	\$46,733,754	\$43,713,119	\$47,865,788	\$47,865,788	\$1,132,034
Miscellaneous Revenues	\$3,476,657	\$300,000	\$797,950	\$300,000	\$300,000	—
Subtotal	\$49,097,693	\$47,851,611	\$45,328,926	\$48,965,788	\$48,965,788	\$1,114,177
Fund Balance	\$(4,954,314)	—	—	—	—	—
General Fund Contributions	\$584,154	\$549,857	\$345,891	\$374,844	\$374,844	\$(175,013)
Total Source of Funds	\$44,727,532	\$48,401,468	\$45,674,817	\$49,340,632	\$49,340,632	\$939,164

Division Description

The Office of the County Counsel non-departmental section consists of individual non-operational units including: Civil Grand Jury, General Liability (GL) Internal Service Fund (ISF), Workers Compensation (WC) ISF, and Enterprise Risk. Specific details on each of the non-departmental units are provided in the individual unit narratives.

Summary of Recommendation

The Fiscal Year (FY) 2023-24 Recommended Budget for County Counsel non-departmental is \$49,340,632 funded by revenues of \$48,965,788 and a general fund contribution (GFC) of \$374,844. Expenditures mainly increased due to excess insurance and property insurance costs; offset by a decrease claims and judgement costs.

Appropriation Expenditure Detail

	Prior Year 2021-2022	Adopted Budget 2022-2023	CY Estimate 2022-2023	Requested Budget 2023-2024	Recommended Budget 2023-2024	Recommended Change from Adopted	Fund Code	Budget Unit Code
Grand Jury (COU005)	439,068	342,952	334,582	324,844	324,844	(18,108)	001	8405
General Liability (COU003)	15,009,286	21,666,611	20,999,051	22,465,788	22,465,788	799,177	475	8408
Workers Compensation (COU004)	29,134,092	26,185,000	24,329,875	26,500,000	26,500,000	315,000	476	8409
Enterprise Risk (COU006)	145,086	206,905	11,309	50,000	50,000	(156,905)	001	8429
Subtotal	\$44,727,532	\$48,401,468	\$45,674,817	\$49,340,632	\$49,340,632	\$939,164		

Grand Jury

(Budget Unit 8405—Fund 001—Appropriation Unit COU005)

Use of Funds

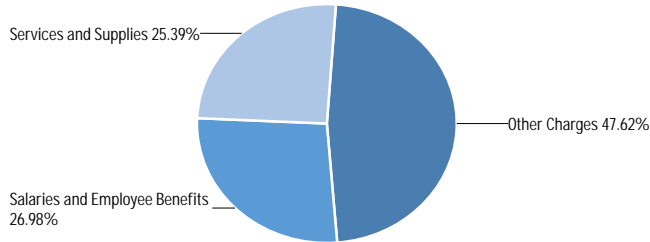

Source of Funds

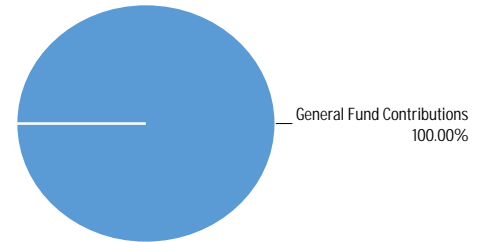

Use of Funds

Expenditures	Prior Year 2021-2022	Adopted Budget 2022-2023	CY Estimate 2022-2023	Requested Budget 2023-2024	Recommended Budget 2023-2024	Recommended Change from Adopted
Salaries and Employee Benefits	\$88,825	\$91,113	\$86,277	\$87,656	\$87,656	\$(3,457)
Services and Supplies	\$69,849	\$78,175	\$74,641	\$82,482	\$82,482	\$4,307
Other Charges	\$280,394	\$173,664	\$173,664	\$154,706	\$154,706	\$(18,958)
Subtotal	\$439,068	\$342,952	\$334,582	\$324,844	\$324,844	\$(18,108)

Source of Funds

Revenues	Prior Year 2021-2022	Adopted Budget 2022-2023	CY Estimate 2022-2023	Requested Budget 2023-2024	Recommended Budget 2023-2024	Recommended Change from Adopted
General Fund Contributions	\$439,068	\$342,952	\$334,582	\$324,844	\$324,844	\$(18,108)
Total Source of Funds	\$439,068	\$342,952	\$334,582	\$324,844	\$324,844	\$(18,108)

Unit Description

The Civil Grand Jury is a constitutionally-mandated body of citizens who volunteer for a one-year term of service. It is assembled annually to investigate the finances, operations, and affairs of local cities, the County, and other local governmental agencies. Typical work products of the Civil Grand Jury include mid-year and final reports and recommendations to the Board of Supervisors, area city councils, and special districts.

In prior years, Civil Grand Jury activities were administered by the Superior Court (on a reimbursement basis). Effective with the empaneling of the 2012 Civil Grand Jury, County Counsel assumed liaison and administrative functions previously handled by the Superior Court.

In FY 2012-13, a Management Analyst was allocated to provide administrative and analytical support. Half of the cost for this position is funded in this unit, with the other half funded in the County Counsel unit.

General Liability

(Budget Unit 8408—Fund 475—Appropriation Unit COU003)

Use of Funds

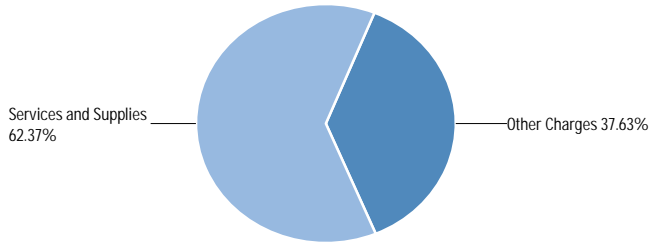

Source of Funds

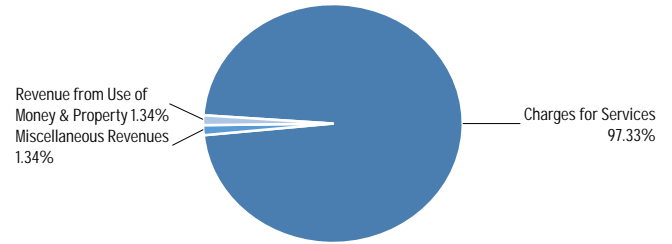

Use of Funds

Expenditures	Prior Year 2021-2022	Adopted Budget 2022-2023	CY Estimate 2022-2023	Requested Budget 2023-2024	Recommended Budget 2023-2024	Recommended Change from Adopted
Services and Supplies	\$9,741,924	\$12,812,090	\$11,243,274	\$14,012,657	\$14,012,657	\$1,200,567
Other Charges	\$5,267,362	\$8,854,521	\$9,755,777	\$8,453,131	\$8,453,131	\$(401,390)
Subtotal	\$15,009,286	\$21,666,611	\$20,999,051	\$22,465,788	\$22,465,788	\$799,177

Source of Funds

Revenues	Prior Year 2021-2022	Adopted Budget 2022-2023	CY Estimate 2022-2023	Requested Budget 2023-2024	Recommended Budget 2023-2024	Recommended Change from Adopted
Fines, Forfeitures, and Penalties	\$1,695	—	—	—	—	—
Revenue from Use of Money & Property	\$163,374	\$317,857	\$317,857	\$300,000	\$300,000	\$(17,857)
Charges for Services	\$21,475,421	\$21,048,754	\$20,681,194	\$21,865,788	\$21,865,788	\$817,034
Miscellaneous Revenues	\$62,506	\$300,000	—	\$300,000	\$300,000	—
Subtotal	\$21,702,996	\$21,666,611	\$20,999,051	\$22,465,788	\$22,465,788	\$799,177
Fund Balance	\$(6,693,710)	—	—	—	—	—
Total Source of Funds	\$15,009,286	\$21,666,611	\$20,999,051	\$22,465,788	\$22,465,788	\$799,177

Unit Description

The General Liability Internal Service Fund is directed and managed by Risk Management and contains expenses for claims, settlements, judgments, administration, legal defense costs, excess insurance premiums and general insurance programs. Liability judgments, settlements, and claims against the County are paid from the GL ISF (Fund 475). Recoveries from external entities are recorded as offsetting revenues in the ISF. ISFs are funded outside the County General Fund and their costs are allocated to departments. Funding of GL claims is based upon the total incurred value of loss and funding as determined by the County's actuaries, based upon loss history and future exposure, and is currently funded at a 70% confidence level for FY 2023-24. Allocations are comprised of two categories:

recoverable and non-recoverable. Both are based on experience and exposure. A given department's allocation may change from year to year due to the following factors: (1) change in payroll and number of employees; (2) change in the department's percentage of total claims paid out over the last seven years; or (3) change in the actuarially-determined total allocation. Debt service, associated with settlement of the Lake Nacimiento and Lake San Antonio litigation, is included with the ISF. This non-recoverable allocation is apportioned on a full-time employee (FTE) basis. The County maintains a Self-Insured Retention (SIR) of \$1.5 million per occurrence and excess coverage, with limits of \$150 million through excess insurance providers. The County self-insures events that are not covered by external insurance providers.

Workers Compensation

(Budget Unit 8409—Fund 476—Appropriation Unit COU004)

Use of Funds

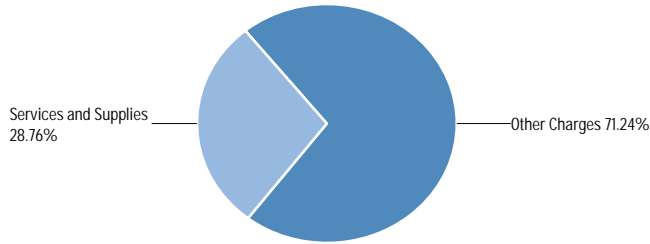

Source of Funds

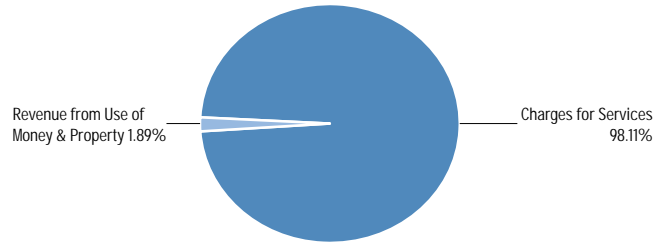

Use of Funds

Expenditures	Prior Year 2021-2022	Adopted Budget 2022-2023	CY Estimate 2022-2023	Requested Budget 2023-2024	Recommended Budget 2023-2024	Recommended Change from Adopted
Services and Supplies	\$5,754,164	\$6,317,655	\$5,431,478	\$7,621,152	\$7,621,152	\$1,303,497
Other Charges	\$23,379,928	\$19,867,345	\$18,898,397	\$18,878,848	\$18,878,848	\$(988,497)
Subtotal	\$29,134,092	\$26,185,000	\$24,329,875	\$26,500,000	\$26,500,000	\$315,000

Source of Funds

Revenues	Prior Year 2021-2022	Adopted Budget 2022-2023	CY Estimate 2022-2023	Requested Budget 2023-2024	Recommended Budget 2023-2024	Recommended Change from Adopted
Revenue from Use of Money & Property	\$422,145	\$500,000	\$500,000	\$500,000	\$500,000	—
Charges for Services	\$23,558,401	\$25,685,000	\$23,031,925	\$26,000,000	\$26,000,000	\$315,000
Miscellaneous Revenues	\$3,414,151	—	\$797,950	—	—	—
Subtotal	\$27,394,697	\$26,185,000	\$24,329,875	\$26,500,000	\$26,500,000	\$315,000
Fund Balance	\$1,739,396	—	—	—	—	—
Total Source of Funds	\$29,134,092	\$26,185,000	\$24,329,875	\$26,500,000	\$26,500,000	\$315,000

Unit Description

The Workers' Compensation Internal Service Fund covers expenses related to claims, settlements, judgments, administration, legal defense costs, and excess insurance premiums. Workers' Compensation-related liability, judgments, settlements, and claims are paid from the WC ISF (Fund 476). Support contributions to this Fund are calculated on a cost recovery basis through charges apportioned to County departments and funds based on experience and exposure. Recoveries from external entities are recorded as offsetting revenues

in the ISF. ISFs are funded outside the County General Fund and their costs are allocated to departments. Funding is based upon total incurred value of loss and funding, as determined by the County's actuaries, based upon loss history and future exposure and currently funded at a 70% confidence level. A given department's allocation may change from year to year due to the following factors: (1) change in payroll and number of employees; (2) change in the department's percentage of total claims paid out over the last seven years; or (3) change in the actuarially-determined total allocation.

Enterprise Risk

(Budget Unit 8429—Fund 001—Appropriation Unit COU006)

Use of Funds

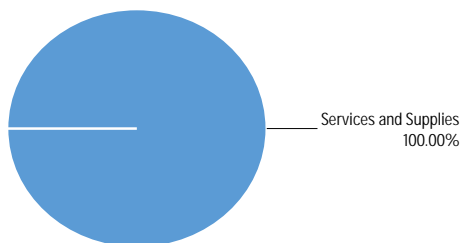

Source of Funds

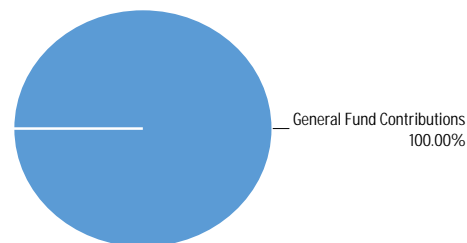

Use of Funds

Expenditures	Prior Year 2021-2022	Adopted Budget 2022-2023	CY Estimate 2022-2023	Requested Budget 2023-2024	Recommended Budget 2023-2024	Recommended Change from Adopted
Services and Supplies	\$139,053	\$207,769	\$12,173	\$50,638	\$50,638	\$(157,131)
Other Charges	\$6,033	\$(864)	\$(864)	\$(638)	\$(638)	\$226
Subtotal	\$145,086	\$206,905	\$11,309	\$50,000	\$50,000	\$(156,905)

Source of Funds

Revenues	Prior Year 2021-2022	Adopted Budget 2022-2023	CY Estimate 2022-2023	Requested Budget 2023-2024	Recommended Budget 2023-2024	Recommended Change from Adopted
General Fund Contributions	\$145,086	\$206,905	\$11,309	\$50,000	\$50,000	\$(156,905)
Total Source of Funds	\$145,086	\$206,905	\$11,309	\$50,000	\$50,000	\$(156,905)

Unit Description

The Enterprise Risk unit is responsible for the tracking of fuel spill costs at Lake San Antonio as well as County risk related settlements

and costs that cannot be passed through for federal and State reimbursement.



This page intentionally left blank.

Clerk of the Board

Departmental Overview:

The Clerk of the Board of Supervisors (COB) performs duties as provided in the California Government Code and/or by formal directives of the Board of Supervisors through the County Administrative Office (CAO). The Clerk of the Board strives to provide the highest level of customer service to the public, County departments, and public agencies. The COB preserves the integrity of the local legislative process by issuing notices of pending matters and decisions made by the legislative body to assure timely access to information by the public and other County departments.

Programs and Functions:

The COB's Office is responsible for carrying out mandated functions including, but not limited to: supporting the Board of Supervisors and County departments in the Board agenda process; maintaining and archiving County records; managing boards, commissions, committees and special district appointments and abiding by the Maddy Act in posting of appointment vacancies; serving as Filing Officer for Statements of Economic Interests Fair Political Practices Commission (Form 700); serving as Administrative Officer in the processing of Assessment Appeals applications and acting as Clerk to the Assessment Appeals Board; serving as Secretary to the City Selection Committee; receiving and responding to Public Records Act Requests; serving as Clerk to various other special districts, and providing administrative support for land use appeals and Williamson Act applications.

Department's Contributions to Monterey County's Strategic Initiatives:

Administration:

Promote an organization that practices efficient and effective resource management and is recognized for responsiveness, strong customer orientation, accountability, and transparency. The Clerk of the Board also uses innovative technologies and other resources and provides timely public access to records and information.



Operating Budget: \$1,207,047
Positions (FTEs): 5.00

Valerie Ralph
Clerk of the Board

Assessment Appeals Board

Clerk of the Board

Staffing Trends

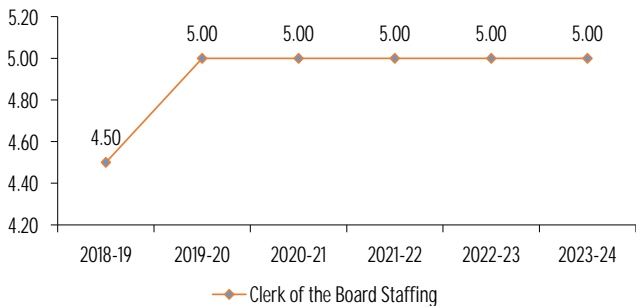

Expenditure/Revenue History (in millions)

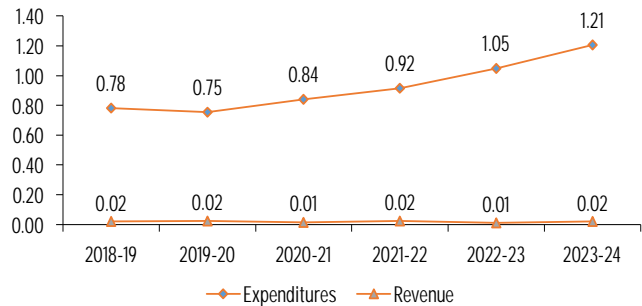

The Clerk of the Board (COB) is the keeper of public trust, facilitating access to information through technology, transparency and excellent customer service. The COB is committed to providing excellent customer service and access to information.

Key Performance Measures	2020-21 Actual	2021-22 Actual	2022-23 Mid-Year
Number of Regular, Special, and BOS governed Agencies and Special District meeting Agendas posted pursuant to Brown Act's 72 hour requirement	110	103	121
Number of applications for changed assessments received and processed.	418	349	400
Percent of assessment appeals reconciled within the two-year time period. Target = 100%	100%	100%	100%
Number of Public Record Act Requests (PRAR) received.	43	4	5
FPPC - Number of Form 700s processed received and processed (hard copy).	133	101	64
Number of Boards, Committees & Commission appointments processed and posted pursuant to the Maddy Act.	167	131	141

Use of Funds

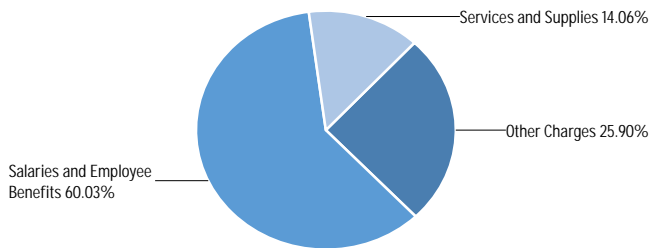

Source of Funds

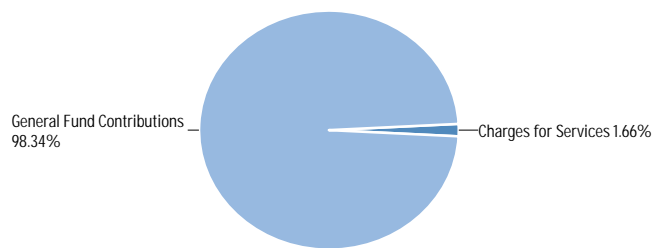

Use of Funds

Expenditures	Prior Year 2021-2022	Adopted Budget 2022-2023	CY Estimate 2022-2023	Requested Budget 2023-2024	Recommended Budget 2023-2024	Recommended Change from Adopted
Salaries and Employee Benefits	\$591,963	\$668,553	\$566,978	\$724,648	\$724,648	\$56,095
Services and Supplies	\$118,089	\$178,581	\$173,675	\$169,718	\$169,718	\$(8,863)
Other Charges	\$206,194	\$308,620	\$308,620	\$312,681	\$312,681	\$4,061
Subtotal	\$916,246	\$1,155,754	\$1,049,273	\$1,207,047	\$1,207,047	\$51,293

Source of Funds

Revenues	Prior Year 2021-2022	Adopted Budget 2022-2023	CY Estimate 2022-2023	Requested Budget 2023-2024	Recommended Budget 2023-2024	Recommended Change from Adopted
Licenses, Permits, and Franchises	\$50	—	—	—	—	—
Charges for Services	\$23,116	\$20,000	\$10,000	\$20,000	\$20,000	—
Subtotal	\$23,166	\$20,000	\$10,000	\$20,000	\$20,000	—
General Fund Contributions	\$893,081	\$1,135,754	\$1,039,273	\$1,187,047	\$1,187,047	\$51,293
Total Source of Funds	\$916,246	\$1,155,754	\$1,049,273	\$1,207,047	\$1,207,047	\$51,293

Summary of Recommendation

The Recommended Budget for the Clerk of the Board (COB) includes \$1,207,047 in appropriations, financed by \$20,000 in revenue associated with assessment appeals filings, and a general fund contribution (GFC) of \$1,187,047. Expenditures increased mainly due to negotiated salaries increases, workers compensation, and pension plans.

Revamped 100 plus boards, commissions and committees in Legistar and public website with the assistance of ITD providing data validation for applications.

Reviewed and enhanced manual processes for the Assessment Appeals Board records to implement technology automation promoting efficiencies pertaining to filing fees and cash receipts.

Continued to revise internal workflow procedures to reduce the need for paper duplication such as Appointment Letters and Oaths of Office being sent electronically vs. mailing hard copies to the appointees/reappointees.

Continued to review the preservation of and access to the County's historically valuable records and files.

Recruited, hired and trained one (1) new Board Clerk.

Participated and collaborated with ITD in the Board Chambers media and audio upgrade which included moving the Board Chamber to the Monterey Room to hold Board meeting during the Board Chambers upgrade project.

Budget Impacts

There are no budget impacts.

Prior Year Accomplishments

Purged and destroyed Assessment Appeals records 5 years and older (60 boxes), and indexed and boxed 26 sub-division files which were sent to records retention.

Documented workflow process to pilot the live Spanish interpretation services via Zoom to mirror the English Board of Supervisors meetings, assisted by Information Technology Department (ITD).

Continued to revise internal workflow procedures reducing paper duplication by replacing hand receipts (paper) with a electronic process.

Budget Year Goals

Document and develop limited English proficiency services.

Continue to revise internal workflow procedures to reduce the need for paper duplication specifically in the Ordinance process with electronic records verses hard copies.

Purge and destroy Board of Supervisors cassette 10 years and older.

Continue to review the preservation of and access to the County's historically valuable records and files.

Pending Issues

There are no pending issues.

Continue to review the public's access to Board of Supervisors records through online resources, including new enhancements to the Board's records management system through the media and audio upgrade project together with ITD.

Policy Considerations

The Department will be exploring historic records preservation/ digitizing in the coming years with the assistance for the County Administrative office. Should the Board of Supervisors want to proceed with any projects, funding will have to be identified.

Complete the Board, commissions and committee records in Legistar and on public website via the new boards, commissions and committees new application created by ITD.

Appropriation Expenditure Detail

	Prior Year 2021-2022	Adopted Budget 2022-2023	CY Estimate 2022-2023	Requested Budget 2023-2024	Recommended Budget 2023-2024	Recommended Change from Adopted	Fund Code	Budget Unit Code
Assessment Appeals Board (COB001)	32,097	94,216	94,335	60,935	60,935	(33,281)	001	8019
Clerk of the Board (COB001)	884,150	1,061,538	954,938	1,146,112	1,146,112	84,574	001	8020
Subtotal	\$916,246	\$1,155,754	\$1,049,273	\$1,207,047	\$1,207,047	\$51,293		

Budget Units

	Prior Year 2021-2022	Adopted Budget 2022-2023	CY Estimate 2022-2023	Requested Budget 2023-2024	Recommended Budget 2023-2024	Recommended Change from Adopted
Assessment Appeals Board	\$32,097	\$94,216	\$94,335	\$60,935	60,935	\$(33,281)
Clerk of the Board	\$884,150	\$1,061,538	\$954,938	\$1,146,112	1,146,112	\$84,574
Subtotal	\$916,246	\$1,155,754	\$1,049,273	\$1,207,047	\$1,207,047	\$51,293

Adopted FY 2022-23 to Recommended FY 2023-24 Positions

Classification Code	Classification Label	Adopted Budget 2021-2022	Adopted Budget 2022-2023	Recommended Budget 2023-2024	Change
11A30	CLERK OF THE BOARD OF SUPERVISORS	1.00	1.00	1.00	0.00
14G02	MANAGEMENT ANALYST I	1.00	1.00	1.00	0.00
80E83	BOARD OF SUPERVISORS CLERK	3.00	3.00	3.00	0.00
	Total	5.00	5.00	5.00	0.00

Assessment Appeals Board

(Budget Unit 8019—Fund 001—Appropriation Unit COB001)

Use of Funds

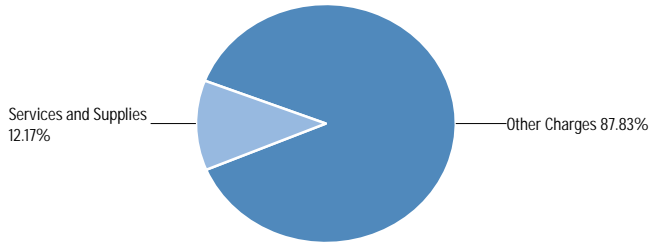

Source of Funds

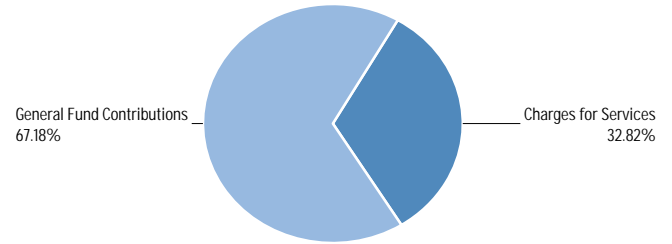

Use of Funds

Expenditures	Prior Year 2021-2022	Adopted Budget 2022-2023	CY Estimate 2022-2023	Requested Budget 2023-2024	Recommended Budget 2023-2024	Recommended Change from Adopted
Salaries and Employee Benefits	\$869	\$44	\$163	—	—	\$(44)
Services and Supplies	\$7,030	\$7,560	\$7,560	\$7,418	\$7,418	\$(142)
Other Charges	\$24,197	\$86,612	\$86,612	\$53,517	\$53,517	\$(33,095)
Subtotal	\$32,097	\$94,216	\$94,335	\$60,935	\$60,935	\$(33,281)

Source of Funds

Revenues	Prior Year 2021-2022	Adopted Budget 2022-2023	CY Estimate 2022-2023	Requested Budget 2023-2024	Recommended Budget 2023-2024	Recommended Change from Adopted
Charges for Services	\$23,098	\$20,000	\$10,000	\$20,000	\$20,000	—
Subtotal	\$23,098	\$20,000	\$10,000	\$20,000	\$20,000	—
General Fund Contributions	\$8,999	\$74,216	\$84,335	\$40,935	\$40,935	\$(33,281)
Total Source of Funds	\$32,097	\$94,216	\$94,335	\$60,935	\$60,935	\$(33,281)

Unit Description

The Assessment Appeals Board (AAB) performs the following duties: accepts applications for changed assessments; reviews applications to ensure they meet the requirements of the State Property Tax Rule 305; provides access to filed assessment appeals applications and related correspondence to the Assessor; responds to taxpayer inquiries regarding assessment appeals applications and hearing procedures; schedules hearings before the AAB and provides

public notice of meeting dates; prepares meeting agendas and provides required notice of scheduled hearing dates to applicants, their representatives and the Assessor; attends AAB meetings; maintains evidence submitted at hearings; prepares post meeting minutes; processes stipulations and withdrawals; transmits Findings of Facts as required; and delivers Statement of Changes to the Auditor-Controller's Office.

Clerk of the Board

(Budget Unit 8020—Fund 001—Appropriation Unit COB001)

Use of Funds

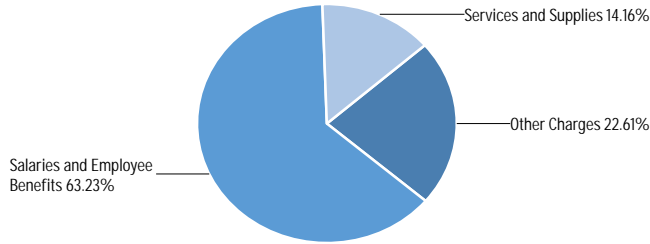

Source of Funds

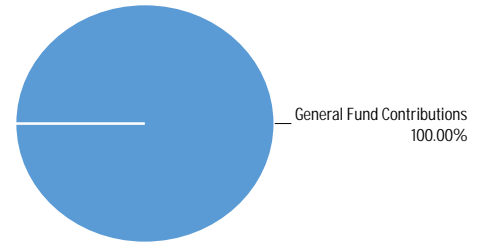

Use of Funds

Expenditures	Prior Year 2021-2022	Adopted Budget 2022-2023	CY Estimate 2022-2023	Requested Budget 2023-2024	Recommended Budget 2023-2024	Recommended Change from Adopted
Salaries and Employee Benefits	\$591,094	\$668,509	\$566,815	\$724,648	\$724,648	\$56,139
Services and Supplies	\$111,059	\$171,021	\$166,115	\$162,300	\$162,300	\$(8,721)
Other Charges	\$181,997	\$222,008	\$222,008	\$259,164	\$259,164	\$37,156
Subtotal	\$884,150	\$1,061,538	\$954,938	\$1,146,112	\$1,146,112	\$84,574

Source of Funds

Revenues	Prior Year 2021-2022	Adopted Budget 2022-2023	CY Estimate 2022-2023	Requested Budget 2023-2024	Recommended Budget 2023-2024	Recommended Change from Adopted
Licenses, Permits, and Franchises	\$50	—	—	—	—	—
Charges for Services	\$18	—	—	—	—	—
Subtotal	\$68	—	—	—	—	—
General Fund Contributions	\$884,082	\$1,061,538	\$954,938	\$1,146,112	\$1,146,112	\$84,574
Total Source of Funds	\$884,150	\$1,061,538	\$954,938	\$1,146,112	\$1,146,112	\$84,574

Unit Description

The Clerk of the Board (COB) is responsible for performing mandated functions, as outlined in the California Government & Revenue & Taxation Codes including, but not limited to: preparing Board of Supervisors meeting agendas & minutes; records maintenance; managing the assessment appeals process (see unit 8019); maintaining and tracking appointments to approximately 75 boards, commissions, committees, and over 80 special districts; processing/routing Public Records Act Requests and information requests from the public and outside agencies. The COB also manages various programs and acts as the Filing Officer for Statement of Economic Interests filings, serves as the Secretary/Clerk for the Monterey County City Selection Committee and other Board-

governed special districts. The COB also receives filings, processes fees, and provides administrative support for land use appeals and Williamson Act applications.

Recommended FY 2023-24 Positions

Classification Code	Classification Label	FTE
11A30	CLERK OF THE BOARD OF SUPERVISORS	1.00
14G02	MANAGEMENT ANALYST I	1.00
80E83	BOARD OF SUPERVISORS CLERK	3.00
	Total	5.00

Elections

Departmental Overview:

The Elections Department conducts federal, State, and local elections, in full compliance with applicable laws and regulations. The Department works to maintain the integrity and transparency of the election process and to provide equitable access to the community. The work of the Department takes place within seven areas:

Programs and Functions:

ADMINISTRATION: Responsible for overseeing all areas of elections, media functions, and finance.

CANDIDATE AND CAMPAIGN SERVICES: Responsible for candidate filing, local initiatives, referendum, and recall petitions. Filing officer for campaign finance disclosure statements.

DATA AND VOTING TECHNOLOGY: Responsible for technological services, network infrastructure, and for producing the ballot, election data reports, voter files and maps.

PRECINCT SERVICES: Responsible for recruiting and training election workers and for coordinating polling place logistics.

VOTE BY MAIL AND EARLY VOTING: Responsible for mailed ballots and early vote center, coordinating ballot return locations, and processing mail ballot returns.

VOTER REGISTRATION SERVICES: Responsible for maintaining and updating voter registration data and ensuring compliance with the National Voter Registration Act.

BILINGUAL OUTREACH AND EDUCATION: Responsible for coordinating the specialized language effort for target audiences that meet the requirements of the federal and State Voting Rights Act and for delivering community presentations and voter registration drive trainings.

Department's Contributions to Monterey County's Strategic Initiatives:

ADMINISTRATION

Elections supports the Board Strategic Initiative of Administration by conducting transparent elections that are accountable to both the integrity of the process and to the public. To fulfill the mission, the Department recruits and trains a large, diverse, skilled workforce to offer innovative, cost effective services that positively impact local agencies and voters while streamlining resources.



Operating Budget: \$6,578,144
Positions (FTEs): 12.00

Gina M. Martinez
Registrar of Voters

Elections

Staffing Trends

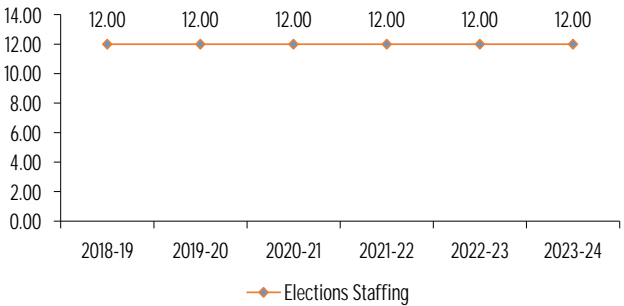

Expenditure/Revenue History (in millions)

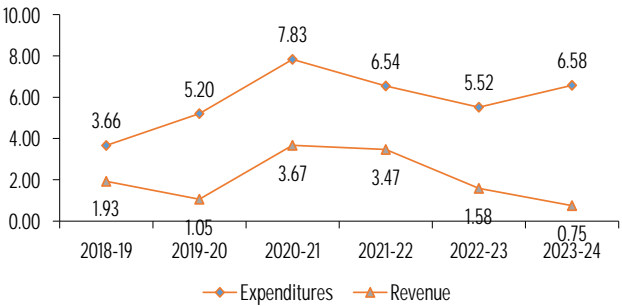

Monterey County Elections serves voters in the administration of elections. Outreach efforts work to educate and empower these voters and those who are eligible to register to vote but have not yet done so; especially those who are underrepresented in the voting population.

Key Performance Measures	2020-21 Actual	2021-22 Actual	2022-23 Mid-Year
Number of registered voters.	206,917	208,274	209,045
Percent of voter turnout.	80.21%	31.08%	49.34%
Number of presentations to community organizations in target groups and areas. Target = 75	75	79	79
Outreach delivered to target areas (low registration and participation). Target = 100%	100%	105%	105%

Use of Funds

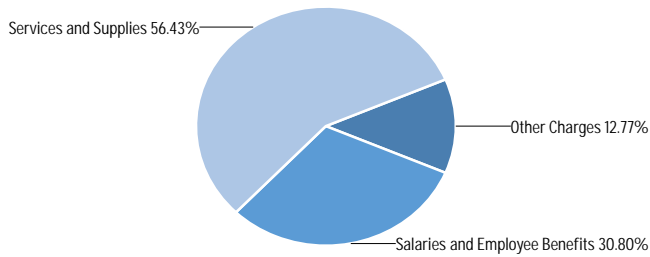

Source of Funds

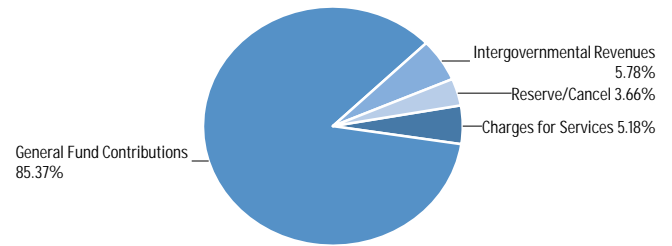

Use of Funds

Expenditures	Prior Year 2021-2022	Adopted Budget 2022-2023	CY Estimate 2022-2023	Requested Budget 2023-2024	Recommended Budget 2023-2024	Recommended Change from Adopted
Salaries and Employee Benefits	\$1,829,562	\$2,096,833	\$2,016,584	\$2,026,333	\$2,026,333	\$(70,500)
Services and Supplies	\$3,586,150	\$2,621,602	\$2,697,349	\$3,814,046	\$3,711,847	\$1,090,245
Other Charges	\$1,128,397	\$804,641	\$804,645	\$839,964	\$839,964	\$35,323
Subtotal	\$6,544,109	\$5,523,076	\$5,518,578	\$6,680,343	\$6,578,144	\$1,055,068

Source of Funds

Revenues	Prior Year 2021-2022	Adopted Budget 2022-2023	CY Estimate 2022-2023	Requested Budget 2023-2024	Recommended Budget 2023-2024	Recommended Change from Adopted
Intergovernmental Revenues	\$266,533	\$575,168	\$575,168	\$394,710	\$394,710	\$(180,458)
Charges for Services	\$3,205,143	\$1,004,000	\$1,005,325	\$354,000	\$354,000	\$(650,000)
Subtotal	\$3,471,676	\$1,579,168	\$1,580,493	\$748,710	\$748,710	\$(830,458)
General Fund Contributions	\$3,072,433	\$3,943,908	\$3,938,085	\$5,681,633	\$5,579,434	\$1,635,526
General Fund - Assigned Fund Balance	—	—	—	\$250,000	\$250,000	\$250,000
Total Source of Funds	\$6,544,109	\$5,523,076	\$5,518,578	\$6,680,343	\$6,578,144	\$1,055,068

Summary of Recommendation

The Recommended Budget for the Elections Department is \$6,578,144 financed by \$748,710 in revenue, \$5,579,434 in general fund contribution (GFC), and \$250,000 from the general capital assignment. Expenditures increase by \$1,055,068 driven by higher printing and mailing charges and temporary employees related to a Presidential Primary Election. The Recommended Budget includes an augmentation of \$1,460,659 funded with ARPA Revenue Loss funds to offset the increase in operational costs of the Presidential Primary Election since fewer number of jurisdictions sharing the cost of the election. Additionally, an augmentation of \$250,000 for technology to enhance the security of election operations is also included and funded by the general capital assignment.

Revenues decrease by \$830,458 next fiscal year due to a reduction in grant funding and lower reimbursements from jurisdictions. Since the Department administers all federal, state, and local elections, expenditures and revenues vary based on the number and type of scheduled and unscheduled elections in a given year.

Budget Impacts

State law mandates local agencies reimburse the County for all election services; however, there is no mandate for the State to reimburse counties for conducting State or federal elections nor for

party central committees to reimburse for their share of election costs in the Presidential Primary Election. Funding of the scheduled Presidential Primary Election in 2024 must be provided by the General Fund, though local revenues may offset a portion of costs. In addition, in the event of a special statewide election, the Department must still comply with all mandates and regulations related to election administration.

County elections officials are required to mail a ballot to every registered voter while maintaining full in-person voting opportunities. While vote-by-mail increases participation of eligible voters, sending every voter a ballot with prepaid postage has increased costs of the Department. SB 504 has increased mailings to those who may be eligible to have voting rights restored at a time when reimbursements for these outreach efforts have been suspended. Further, with the enactment of AB 1416, additional lines of text listing both proponents and opponents will be added to all state propositions and potentially to local measures which may lead to an additional ballot card bringing Monterey County to three ballot cards in the General Election.

Due to COVID-19 related supply chain issues, staffing shortages and unprecedented inflationary pressures, the Department may experience a significant increase in election related costs. The unknown impact raises a certain degree of budget uncertainty for the upcoming fiscal year.

Prior Year Accomplishments

Administered the November 8, 2022, Statewide General Election. During this time, the Department officially launched the mobile/flex voting programs without increasing the overall cost of the election. The mobile/flex voting programs, piloted in the 2022 Statewide Primary Election, brings additional outreach efforts and election support directly to communities across the County during the most critical early voting period.

Implemented brand new boundaries for jurisdictions that moved from an at-large method of voting to a by-district method of voting as well as new boundaries related to a condensed redistricting period while conducting two major elections and two special elections. During the Statewide General Election, voter turnout reached 49.34% of 209,045 registered voters.

Launched the poll worker advisory group and outreach volunteer group, consisting of volunteers with some level of expertise in elections who provide feedback on training materials and assist with recruitment efforts. The outreach volunteer group is comprised of trained volunteers who table outreach events and engage with the public on topics including how to participate as a voter and a volunteer.

Maintained leadership roles in the California Association of Clerks and Election Officials (CACEO), including the Registrar of Voters who chairs the Recount Subcommittee. In addition, Elections Program Managers serve on the State Language Accessibility Advisory Committee and the Voter Accessibility Advisory Committee. Additional staff members are actively participating in CACEO committees working on voting accessibility, language services, and petition standardization.

Budget Year Goals

The primary functional goal is to conduct scheduled and unscheduled elections in compliance with federal, state and local laws. One election is scheduled in FY 2023-2024: the March 5, 2024 Presidential Primary Election.

Seek new methods and modes to engage in voter outreach and civic engagement, including partnerships with service agencies, schools, colleges, and community organizations. Most significantly, the Department will continue to expand in person voting and registration opportunities with the use of the mobile voting unit.

Launch a youth leadership program that will engage and empower youth to promote voter registration and participation amongst their peers.

Identify additional avenues in which to enhance the security of elections. To that end, the Department will seek to implement additional security measures at ballot return locations and within the office.

Pending Issues

SPECIAL ELECTIONS

A special unscheduled election may be called at any point in time from any jurisdiction state or local jurisdiction.

VOTING SYSTEMS

The Department continues to seek a viable funding mechanism to fund voting systems in conjunction with partial matching federal grant funds from the Secretary of State. Jurisdictions are billed according to the election cycle on a pro-rata basis to partially offset ongoing leasing expenses. Current HAVA grant funds to finance voting technology are set to rollover to FY 2023-24 and are in the final stages of claims.

NEW LAW

The State continues to introduce and pass legislation that would require additional technology and services at polling places around the County. The direction the Department will be ordered to take is unknown. Continued participation in the CACEO Legislative Committee will keep the Department informed of new legislation and related impacts to elections.

Policy Considerations

The Department will monitor State legislation that is in line with the Board's legislative priorities such as those that support efficient administrative operations while expanding access to and enhancing integrity of elections. Likewise, it will continue to develop the public observer panel and other committees to improve voting accessibility, transparency, access, and public education activities. Additionally, the Department's involvement at the CACEO supports legislation to fund elections at the federal and State level to minimize costs for local agencies.

Appropriation Expenditure Detail

	Prior Year 2021-2022	Adopted Budget 2022-2023	CY Estimate 2022-2023	Requested Budget 2023-2024	Recommended Budget 2023-2024	Recommended Change from Adopted	Fund Code	Budget Unit Code
Elections (ELE001)	6,544,109	5,523,076	5,518,578	6,680,343	6,578,144	1,055,068	001	8064
Subtotal	\$6,544,109	\$5,523,076	\$5,518,578	\$6,680,343	\$6,578,144	\$1,055,068		

Budget Units

	Prior Year 2021-2022	Adopted Budget 2022-2023	CY Estimate 2022-2023	Requested Budget 2023-2024	Recommended Budget 2023-2024	Recommended Change from Adopted
Elections	\$6,544,109	\$5,523,076	\$5,518,578	\$6,680,343	6,578,144	\$1,055,068
Subtotal	\$6,544,109	\$5,523,076	\$5,518,578	\$6,680,343	\$6,578,144	\$1,055,068

Adopted FY 2022-23 to Recommended FY 2023-24 Positions

Classification Code	Classification Label	Adopted Budget 2021-2022	Adopted Budget 2022-2023	Recommended Budget 2023-2024	Change
11A20	REGISTRAR OF VOTERS	1.00	1.00	1.00	0.00
12C14	ASSISTANT REGISTRAR OF VOTERS	1.00	1.00	1.00	0.00
14C30	MANAGEMENT ANALYST II	1.00	1.00	1.00	0.00
14J21	ELECTIONS SERVICES SPECIALIST II	2.00	2.00	2.00	0.00
14M80	ELECTIONS PROGRAM MANAGER	5.00	5.00	5.00	0.00
16C87	BUSINESS TECHNOLOGY ANALYST II	1.00	1.00	1.00	0.00
43J09	SENIOR DEPARTMENTAL INFORMATION SYSTEMS COORDINATOR	1.00	1.00	1.00	0.00
Total		12.00	12.00	12.00	0.00

Augmentation Requests

Request Code	Request Name	Ranking Type Name	Requested Amount	Requested FTE	Recommended Budget	Recommended FTE
1410-8064-001-AUG1	Operational expense for Primary Presidential Election	Status Quo Other	1,562,858	-	1,460,659	-
1410-8064-001-AUG2	Election Hardware / Software	Status Quo Other	250,000	-	250,000	-
Grand Total:			\$1,812,858	-	\$1,710,659	-



This page intentionally left blank.

Emergency Communications

Departmental Overview:

The Emergency Communications Department (ECD) operates the Countywide consolidated emergency communications system. Emergency and non-emergency call answering and dispatch services are provided to the County Sheriff, Probation Department, 11 of the 12 incorporated city police departments, fire agencies for all 12 cities, three County fire districts, the Monterey Regional Airport District, Salinas Valley State Prison, and California State University Monterey Bay Police Department. These services are provided under the Agreement for 9-1-1 Emergency Communications Dispatch Services (9-1-1 Services Agreement).

Programs and Functions:

The ECD is the primary Public Safety Answering Point (PSAP) for the County of Monterey. The ECD provides all emergency and non-emergency call taking services and dispatch of law enforcement and fire field units including status reporting and associated activity for after-hours dispatch of the public works crews. The ECD also provides and maintains consoles and associated radio dispatch equipment located in its communications center.

As defined in the billing formula in the 911 Services Agreement, costs for dispatch and call taking services are calculated through an equally weighted, three-factor allocation ratio of Assessed Property Value, Population, and Workload. Each dollar of expense for operating the emergency communications center is paid for by approximately 30 cents of County funding and 70 cents in user agency revenue. The County funding represents the cost of service provided to the Probation Department, Sheriff's Office and a 90% subsidy to fire districts.

The ECD also bills users of the Countywide Next Generation Radio System (NGEN) for Operations & Maintenance (O&M) costs. These costs are billed to 26 agencies based on the percentage of radios in use.

Department's Contribution to Monterey County's Strategic Initiatives:

PUBLIC SAFETY

Creating a safe environment for people to achieve their potential, leading businesses and communities to thrive and grow by reducing violent crimes as well as crimes in general, with the key objective to engage public safety stakeholders, partners, and the whole community in resiliency building activities including emergency reporting.



Operating Budget: \$15,616,044
Positions (FTEs): 75.00

Lee Ann Magoski
Director

Emergency Communications

Staffing Trends

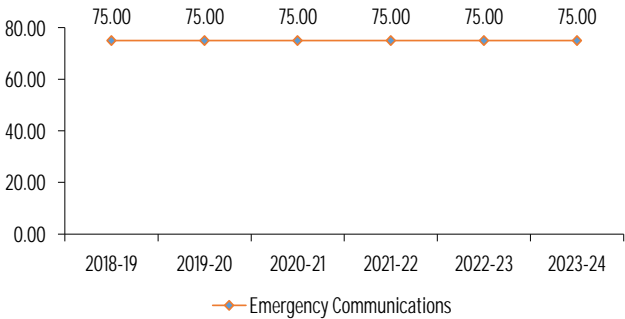

Expenditure/Revenue History (in millions)

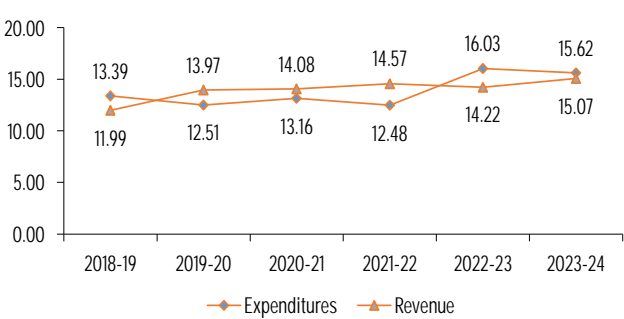

The Emergency Communications Department is the primary public safety answering point for the County of Monterey and provides 9-1-1 and non-emergency call taking services to the majority of the County's residents and visitors. The Department also provides law and fire dispatch services to public safety agencies across the County.

Key Performance Measures	2020-21 Actual	2021-22 Actual	2022-23 Mid-Year
Number of emergency calls answered.	239,4634	241,334	126,756
Number of non-emergency calls answered.	496,489	486,679	245,248
Number of emergency calls requiring language translation services provided.	20,078	22,475	9,145
Percentage of emergency calls answered within 15 seconds. Target = 95%	92%	89%	88%
Number of law enforcement service calls generated.	407,941	413,088	203,494
Number of fire protection service calls generated.	49,879	53,866	28,755
Number of Text to 9-1-1 Calls received	2,347	2,758	1,583

Use of Funds

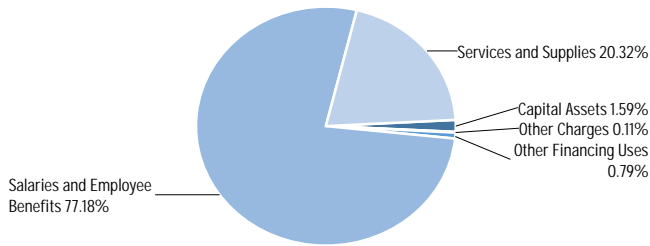

Source of Funds

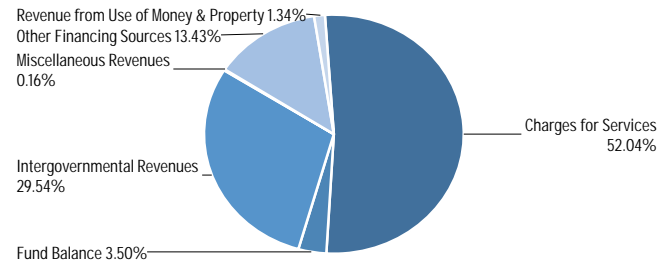

Use of Funds

Expenditures	Prior Year 2021-2022	Adopted Budget 2022-2023	CY Estimate 2022-2023	Requested Budget 2023-2024	Recommended Budget 2023-2024	Recommended Change from Adopted
Salaries and Employee Benefits	\$10,035,215	\$11,020,280	\$11,349,311	\$12,051,910	\$12,051,910	\$1,031,630
Services and Supplies	\$2,335,524	\$2,749,652	\$2,651,711	\$3,173,466	\$3,173,466	\$423,814
Other Charges	\$93,503	\$(271,984)	\$(271,984)	\$17,813	\$17,813	\$289,797
Capital Assets	\$13,072	\$1,876,254	\$1,627,508	\$248,786	\$248,786	\$(1,627,468)
Other Financing Uses	—	\$677,267	\$677,267	\$124,069	\$124,069	\$(553,198)
Subtotal	\$12,477,314	\$16,051,469	\$16,033,813	\$15,616,044	\$15,616,044	\$(435,425)

Source of Funds

Revenues	Prior Year 2021-2022	Adopted Budget 2022-2023	CY Estimate 2022-2023	Requested Budget 2023-2024	Recommended Budget 2023-2024	Recommended Change from Adopted
Revenue from Use of Money & Property	\$192,784	\$176,687	\$176,687	\$209,573	\$209,573	\$32,886
Intergovernmental Revenues	\$4,724,075	\$4,365,787	\$4,506,552	\$4,612,397	\$4,612,397	\$246,610
Charges for Services	\$8,038,034	\$7,981,615	\$7,981,615	\$8,126,074	\$8,126,074	\$144,459
Miscellaneous Revenues	\$12,036	\$7,000	\$7,000	\$25,000	\$25,000	\$18,000
Other Financing Sources	\$1,602,097	\$2,313,380	\$1,549,965	\$2,096,951	\$2,096,951	\$(216,429)
Subtotal	\$14,569,026	\$14,844,469	\$14,221,819	\$15,069,995	\$15,069,995	\$225,526
Fund Balance	\$(2,091,712)	\$1,207,000	\$1,811,994	\$546,049	\$546,049	\$(660,951)
Total Source of Funds	\$12,477,314	\$16,051,469	\$16,033,813	\$15,616,044	\$15,616,044	\$(435,425)

Summary of Recommendation

The Fiscal Year (FY) 2023-24 Recommended Budget for the Emergency Communications Department is \$15,616,044 financed by \$15,069,995 in revenue, including a County contribution of \$1,972,882 included as an operating transfer in, and \$546,029 in fund balance. The Department is adding \$329,000 to the Department's strategic reserve for dispatch. Expenditures decreased by \$435,425 from FY 2022-23 primarily due to a reduction of \$1,536,000 in the NGEN Capital Project Fund and this decrease was partially offset by a wage study for the 65 FTEs in the Dispatcher series which resulted in a 15.94% increase to base wages, increased cost plan charges, and a 2.5% COLA for all staff.

The Recommended Budget for the Emergency Communications Department includes two special revenue funds and one Capital Project Fund.

Special Revenue Fund 028: The Dispatch Operations Fund has a FY 2023-24 Recommended Budget of \$14,734,982 where approximately

70% of the operational costs are shared by non-County user agencies. The Recommended Budget includes an augmentation to restore three vacant Dispatchers that were at risk due to cost pressures. The augmentation was funded with \$300,189 additional revenue reimbursement from the various users and \$115,489 County contribution funded by ARPA Revenue Loss.

Special Revenue Fund 026: The Next Generation (NGEN) Radio System Operations and Maintenance Fund has an FY 2023-24 Recommended Budget of \$881,082. This budget is created in partnership with the Information Technology Department (ITD), based on estimated costs related to the maintenance and operation of the NGEN Radio System then is reviewed by the ECD Executive Board. These costs are then billed to the user agencies by the ECD. ITD controls the majority of expenditures within the budget and recovers the costs from the ECD.

Capital Project Fund 405: The NGEN Capital Project Fund does not have any planned expenses in FY 2023-24.

Budget Impacts

There are no budget impacts.

Prior Year Accomplishments

During FY 2021-22, the Dispatch Center received 728,013 calls of which 241,334 were 9-1-1 calls. 89% of 9-1-1 calls were answered in 15 seconds or less.

In partnership with the Information Technology Department (ITD), the Department developed and executed an NGEN Agreement. The Next Generation Radio Public Safety Radio System agreements to date have been focused on the initial buildout of the system. Prior to this Agreement, NGEN costs were billed under the authority of the 9-1-1 Services Agreement. This agreement covers NGEN System governance, technical oversight, and fiscal administration.

Implemented Amazon Web Services Connect, an Artificial Intelligence technology that has been used successfully in other customer service settings to allow the system to converse and satisfy the caller's request. The technology can continue to grow as it learns how to direct the callers to the necessary information and provides the Department with more analytics to be able to anticipate what callers are requesting. This will improve the speed of the call process, allowing more services to be done without the intervention of the Communications Dispatcher, who can now focus their time on 9-1-1 calls, law and fire resource management and critical incidents. This will be offered in English and Spanish and there will be mechanisms in place for emergency calls to be routed to a Dispatcher.

Created and filled a new Department Information System Coordinator (DISC) position to assist the Senior DISC with technology projects and day to day technical maintenance. Three Management Analyst III positions were reclassified to Emergency Communications Managers and given a wage increase; appropriate classification and compensation will assist in recruitment and provide a path to promote with the Department.

Completed a major upgrade to the Computer Aided Dispatch system that resolved many long-standing issues in the system and allows for

more efficient workflow. The ECD continues to recruit, hire, and train new dispatchers. In August of 2022 the Department opened an ongoing and continuous lateral recruitment. Hiring is a challenge given the complexity of the job and the success rate for new hires is roughly 50% in an 18-month training program. In order to maintain staffing levels to serve the community, mandatory overtime remains high. A salary study was completed for the Dispatcher Series positions resulting in a 15.94% raise and the Department anticipates this will help future hiring efforts.

Budget Year Goals

Complete a perimeter fence around the primary dispatch center/emergency operations center building. The Department has budgeted funds for its portion of this project in the FY 2023-24 Recommended Budget. The building is shared with the Department of Emergency Management and this project will secure the building that houses the County Emergency Operations Center and 9-1-1 Dispatch center and associated parking areas inside a secured fence.

Rehost the Computer Aided Dispatch (CAD) system because the current server hardware and software are at end of life. This rehost is required to continue to continue with future CAD upgrades from the vendor.

Continue to conduct new employee academies throughout the year with the goal of recruiting, hiring, and training to fill existing vacancies which will reduce mandatory overtime.

Continue to find technological efficiencies that add value to the goals of public safety agencies in the County of Monterey.

Pending Issues

There are no pending issues.

Policy Considerations

There are no policy considerations.

Appropriation Expenditure Detail

	Prior Year 2021-2022	Adopted Budget 2022-2023	CY Estimate 2022-2023	Requested Budget 2023-2024	Recommended Budget 2023-2024	Recommended Change from Adopted	Fund Code	Budget Unit Code
Emergency Communication (EME002)	0	1,536,000	1,536,000	0	0	(1,536,000)	405	8426
NGEN Operations & Maintenance (EME003)	735,715	1,606,116	1,606,116	881,062	881,062	(725,054)	026	8480
Emergency Communications (EME004)	11,741,600	12,909,353	12,891,697	14,734,982	14,734,982	1,825,629	028	8507
Subtotal	\$12,477,314	\$16,051,469	\$16,033,813	\$15,616,044	\$15,616,044	\$(435,425)		

Budget Units

	Prior Year 2021-2022	Adopted Budget 2022-2023	CY Estimate 2022-2023	Requested Budget 2023-2024	Recommended Budget 2023-2024	Recommended Change from Adopted
Emergency Communication	—	\$1,536,000	\$1,536,000	—	—	\$(1,536,000)
NGEN Operations & Maintenance	\$735,715	\$1,606,116	\$1,606,116	\$881,062	\$881,062	\$(725,054)
Emergency Communications	\$11,741,600	\$12,909,353	\$12,891,697	\$14,734,982	\$14,734,982	\$1,825,629
Subtotal	\$12,477,314	\$16,051,469	\$16,033,813	\$15,616,044	\$15,616,044	\$(435,425)

Adopted FY 2022-23 to Recommended FY 2023-24 Positions

Classification Code	Classification Label	Adopted Budget 2021-2022	Adopted Budget 2022-2023	Recommended Budget 2023-2024	Change
12C42	EMERGENCY COMMUNICATIONS OPERATIONS MANAGER	1.00	1.00	1.00	0.00
14A26	DIRECTOR OF EMERGENCY COMMUNICATIONS	1.00	1.00	1.00	0.00
14C31	MANAGEMENT ANALYST III	3.00	3.00	0.00	(3.00)
14C70	ADMINISTRATIVE SERVICES ASSISTANT	1.00	1.00	1.00	0.00
14M13	EMERGENCY COMMUNICATIONS MANAGER	0.00	0.00	3.00	3.00
20B93	FINANCE MANAGER II	1.00	1.00	1.00	0.00
43J05	DEPARTMENTAL INFORMATION SYSTEMS COORDINATOR	0.00	1.00	1.00	0.00
43J09	SENIOR DEPARTMENTAL INFORMATION SYSTEMS COORDINATOR	1.00	1.00	1.00	0.00
80A99	ADMINISTRATIVE SECRETARY-CONFIDENTIAL	1.00	1.00	1.00	0.00
80S01	COMMUNICATIONS DISPATCHER I	6.00	6.00	6.00	0.00
80S21	COMMUNICATIONS DISPATCHER II	50.00	50.00	50.00	0.00
80S22	EMERGENCY COMMUNICATIONS SHIFT SUPERVISOR	10.00	9.00	9.00	0.00
Total		75.00	75.00	75.00	0.00

Emergency Communications

Augmentation Request

Request Code	Request Name	Ranking Type Name	Requested Amount	Requested FTE	Recommended Budget	Recommended FTE
1520-8507-028-AUG1	Restore Vacant Dispatchers	Status Quo Vacant Position	-	3.00	-	3.00
Grand Total:			\$ -	3.00	\$ -	3.00

Emergency Communication

(Budget Unit 8426—Fund 405—Appropriation Unit EME002)

Use of Funds

Source of Funds

Intentionally Left Blank

Intentionally Left Blank

Use of Funds

Expenditures	Prior Year 2021-2022	Adopted Budget 2022-2023	CY Estimate 2022-2023	Requested Budget 2023-2024	Recommended Budget 2023-2024	Recommended Change from Adopted
Capital Assets	—	\$1,536,000	\$1,536,000	—	—	\$(1,536,000)
Subtotal	—	\$1,536,000	\$1,536,000	—	—	\$(1,536,000)

Source of Funds

Revenues	Prior Year 2021-2022	Adopted Budget 2022-2023	CY Estimate 2022-2023	Requested Budget 2023-2024	Recommended Budget 2023-2024	Recommended Change from Adopted
Revenue from Use of Money & Property	\$4,435	—	—	—	—	—
Other Financing Sources	—	\$538,267	\$538,267	—	—	\$(538,267)
Subtotal	\$4,435	\$538,267	\$538,267	—	—	\$(538,267)
Fund Balance	\$(4,435)	\$997,733	\$997,733	—	—	\$(997,733)
Total Source of Funds	—	\$1,536,000	\$1,536,000	—	—	\$(1,536,000)

Unit Description

This Capital Project Fund contains the capital projects for the County-wide Next Generation (NGEN) Public Safety Radio System. The fiscal administration, governance and technical oversight of these projects are controlled through the NGEN Services Agreement. The

NGEN system is used by 33 public safety agencies across the County and four public works departments. These agencies are charged for the capital project costs through the NGEN Services Agreement.

This fund's budget is created in partnership with the Information Technology Department.

NGEN Operations & Maintenance

(Budget Unit 8480—Fund 026—Appropriation Unit EME003)

Use of Funds

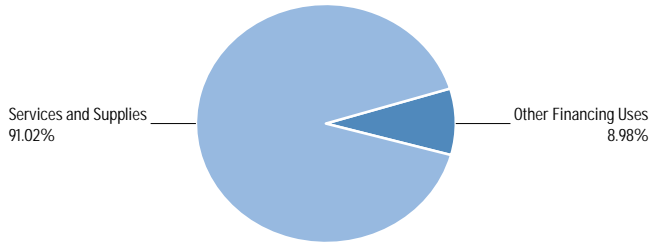

Source of Funds

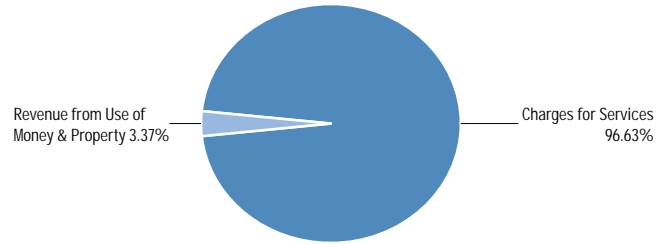

Use of Funds

Expenditures	Prior Year 2021-2022	Adopted Budget 2022-2023	CY Estimate 2022-2023	Requested Budget 2023-2024	Recommended Budget 2023-2024	Recommended Change from Adopted
Services and Supplies	\$1,064,574	\$1,210,643	\$1,210,643	\$1,258,276	\$1,258,276	\$47,633
Other Charges	\$(328,859)	\$(281,794)	\$(281,794)	\$(501,283)	\$(501,283)	\$(219,489)
Other Financing Uses	—	\$677,267	\$677,267	\$124,069	\$124,069	\$(553,198)
Subtotal	\$735,715	\$1,606,116	\$1,606,116	\$881,062	\$881,062	\$(725,054)

Source of Funds

Revenues	Prior Year 2021-2022	Adopted Budget 2022-2023	CY Estimate 2022-2023	Requested Budget 2023-2024	Recommended Budget 2023-2024	Recommended Change from Adopted
Revenue from Use of Money & Property	\$33,891	\$28,800	\$28,800	\$29,664	\$29,664	\$864
Charges for Services	\$1,060,650	\$1,039,049	\$1,039,049	\$851,398	\$851,398	\$(187,651)
Subtotal	\$1,094,542	\$1,067,849	\$1,067,849	\$881,062	\$881,062	\$(186,787)
Fund Balance	\$(358,827)	\$538,267	\$538,267	—	—	\$(538,267)
Total Source of Funds	\$735,715	\$1,606,116	\$1,606,116	\$881,062	\$881,062	\$(725,054)

Unit Description

The Operations and Maintenance of the Next Generation (NGEN) System’s governance, technical oversight, and fiscal administration are controlled through the NGEN Services Agreement. This special revenue fund provides for the operations and maintenance of the NGEN Radio System. The NGEN system is used by 33 public safety agencies across the County and four public works departments. This fund includes costs only for operation and maintenance of the current system including the Very High Frequency (VHF) radio system,

control stations, microwave stations for backhaul, replacement of dispatch consoles, and network and information technology security systems.

This fund’s budget is created in partnership with the Information Technology Department (ITD) and recommended to the Executive Board of the Emergency Communications Department (ECD) for review. These costs are then billed to the system users by the ECD and the majority of the revenue is transferred back to ITD for NGEN operations and maintenance.

Emergency Communications

(Budget Unit 8507—Fund 028—Appropriation Unit EME004)

Use of Funds

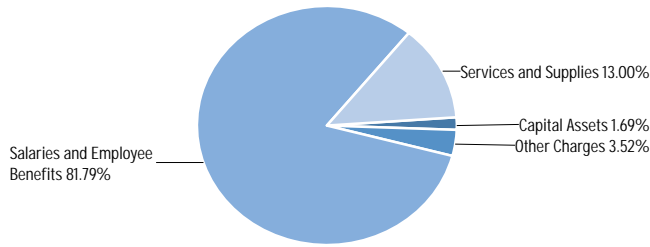

Source of Funds

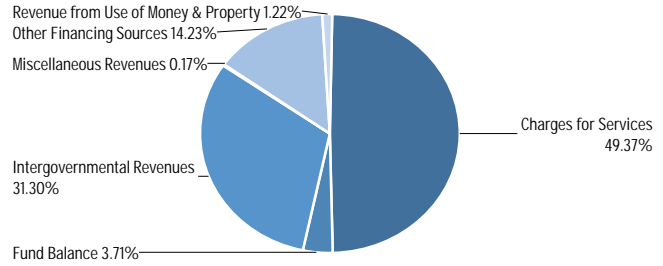

Use of Funds

Expenditures	Prior Year 2021-2022	Adopted Budget 2022-2023	CY Estimate 2022-2023	Requested Budget 2023-2024	Recommended Budget 2023-2024	Recommended Change from Adopted
Salaries and Employee Benefits	\$10,035,215	\$11,020,280	\$11,349,311	\$12,051,910	\$12,051,910	\$1,031,630
Services and Supplies	\$1,270,950	\$1,539,009	\$1,441,068	\$1,915,190	\$1,915,190	\$376,181
Other Charges	\$422,362	\$9,810	\$9,810	\$519,096	\$519,096	\$509,286
Capital Assets	\$13,072	\$340,254	\$91,508	\$248,786	\$248,786	\$(91,468)
Subtotal	\$11,741,600	\$12,909,353	\$12,891,697	\$14,734,982	\$14,734,982	\$1,825,629

Source of Funds

Revenues	Prior Year 2021-2022	Adopted Budget 2022-2023	CY Estimate 2022-2023	Requested Budget 2023-2024	Recommended Budget 2023-2024	Recommended Change from Adopted
Revenue from Use of Money & Property	\$154,458	\$147,887	\$147,887	\$179,909	\$179,909	\$32,022
Intergovernmental Revenues	\$4,724,075	\$4,365,787	\$4,506,552	\$4,612,397	\$4,612,397	\$246,610
Charges for Services	\$6,977,383	\$6,942,566	\$6,942,566	\$7,274,676	\$7,274,676	\$332,110
Miscellaneous Revenues	\$12,036	\$7,000	\$7,000	\$25,000	\$25,000	\$18,000
Other Financing Sources	\$1,602,097	\$1,775,113	\$1,011,698	\$2,096,951	\$2,096,951	\$321,838
Subtotal	\$13,470,050	\$13,238,353	\$12,615,703	\$14,188,933	\$14,188,933	\$950,580
Fund Balance	\$(1,728,450)	\$(329,000)	\$275,994	\$546,049	\$546,049	\$875,049
Total Source of Funds	\$11,741,600	\$12,909,353	\$12,891,697	\$14,734,982	\$14,734,982	\$1,825,629

Unit Description

In this special revenue fund, the Department operates the countywide consolidated emergency communications system. Emergency and non-emergency call answering and dispatch services are provided to the County Sheriff, Probation Department, 11 of the 12 incorporated city police departments, fire agencies for all 12 cities, three County fire districts, the Monterey Regional Airport District, Salinas Valley State Prison, and California State University Monterey Bay police department. These services are provided under the Agreement for 9-1-1 Emergency Communications Dispatch Services (911 Services Agreement).

Recommended FY 2023-24 Positions

Classification Code	Classification Label	FTE
12C42	EMERGENCY COMMUNICATIONS OPERATIONS MANAGER	1.00
14A26	DIRECTOR OF EMERGENCY COMMUNICATIONS	1.00
14C70	ADMINISTRATIVE SERVICES ASSISTANT	1.00
14M13	EMERGENCY COMMUNICATIONS MANAGER	3.00
20B93	FINANCE MANAGER II	1.00
43J05	DEPARTMENTAL INFORMATION SYSTEMS COORDINATOR	1.00
43J09	SENIOR DEPARTMENTAL INFORMATION SYSTEMS COORDINATOR	1.00

Recommended FY 2023-24 Positions

Classification Code	Classification Label	FTE
80A99	ADMINISTRATIVE SECRETARY- CONFIDENTIAL	1.00
80S01	COMMUNICATIONS DISPATCHER I	6.00
80S21	COMMUNICATIONS DISPATCHER II	50.00
80S22	EMERGENCY COMMUNICATIONS SHIFT SUPERVISOR	9.00
	Total	75.00



This page intentionally left blank.

Information Technology

Departmental Overview:

The Information Technology Department (ITD) is responsible for delivering strategic information technology solutions to support internal County operations and business activities. ITD resources are operated and maintained in a manner that supports high availability for utilization and minimizes the risk of business interruption. ITD's focus is on developing a sustainable, customer-focused environment to enhance and improve the quality of technology services used by County departments for the benefit of all Monterey County residents, businesses, and visitors.

Programs and Functions:

ITD consists of the Business Office; Applications & Customer Support; Infrastructure & Operations; and Information Security.

ECONOMIC DEVELOPMENT

In conjunction with telecom service providers, continue to extend the broadband footprint throughout the county.

ADMINISTRATION

Deliver modern technology infrastructure to enhance the ability to serve the public and provide robust voice, data, video, and radio services.

HEALTH AND HUMAN SERVICES

Develop and deploy modern technical solutions to provide effective and efficient services to county constituents.

INFRASTRUCTURE

Deploy sustainable cost-effective technologies by migrating aging infrastructure and applications to cloud and SaaS environments.

PUBLIC SAFETY

Deliver technologies that improve the overall safety of county constituents and improve the ability of public safety officials to respond to events with the implementation of the Next Generation Digital Radio System.

MONTEREY COUNTY INFORMATION TECHNOLOGY

TRANSFORMING GOVERNMENT THROUGH INNOVATIVE TECHNOLOGY

[Learn More](#)

APPLICATIONS
Provides enterprise application solutions and support, website development, software engineering, GIS, and database services.

SERVICE DELIVERY
Assists in planning, acquisition, installation, trouble shooting, technical support and maintenance of hardware and software solutions.

ENTERPRISE OPERATIONS
Provides enterprise architecture and operations, data center facility and operations support, physical and virtual server and storage, design and administration.

INFRASTRUCTURE
Architects, designs, builds and administers a scalable technology framework that transports information via voice, video, data and radio services.

SECURITY
Implements security solutions and conducts threat hunting, incident response, investigation, awareness and assessment activities to eliminate and minimize information security risks.

© 2017 County of Monterey
Information Technology Department

Information Technology

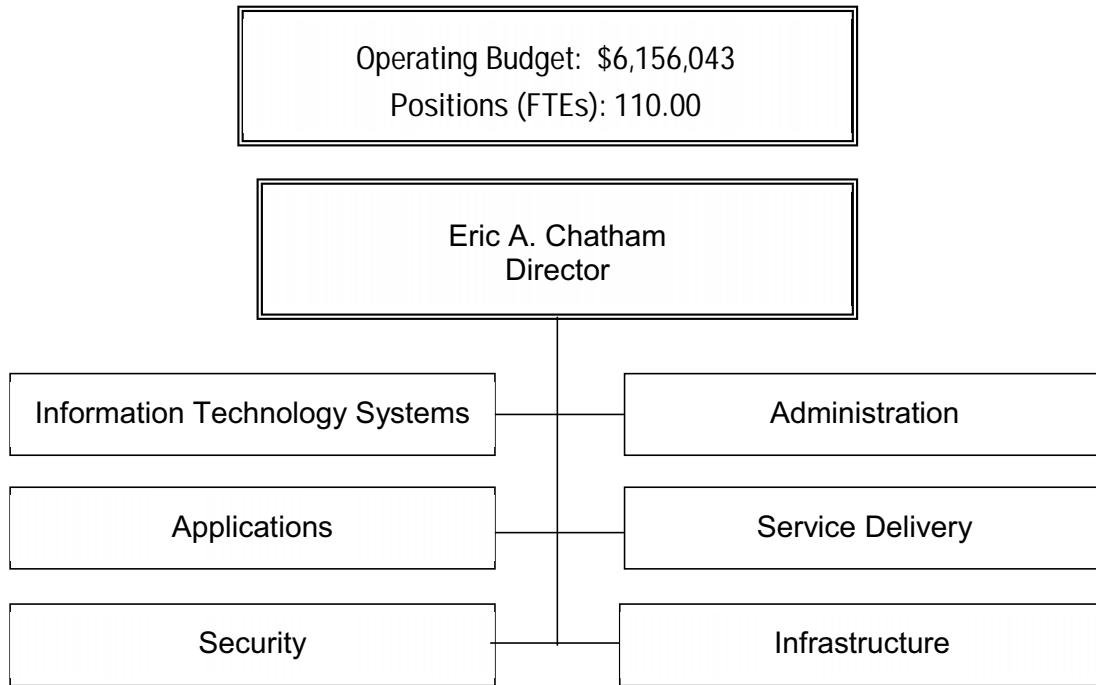

Staffing Trends

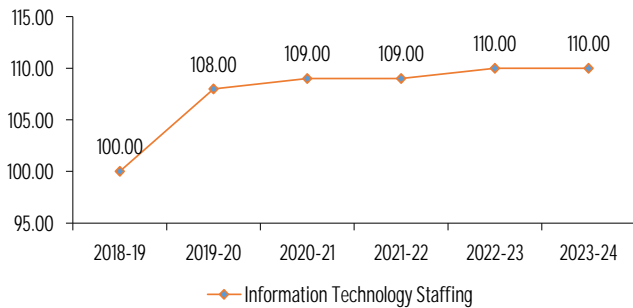

Expenditure/Revenue History (in millions)

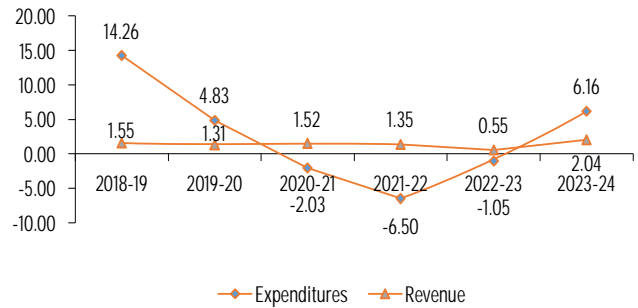

The Information Technology Department (ITD) enables County business by delivering state of the art technology solutions in a strategic, cost-effective, and efficient manner. ITD supports internal County operations and associated business activities, outside public agencies, residents, and visitors.

Key Performance Measures	2020-21 Actual	2021-22 Actual	2022-23 Mid-Year
Percentage of surveyed customers that rate ITD services provided as satisfied or very satisfied. Target = 90%.	97.0%	97.5%	97.0%
Total ITD spent as a percent of total County revenue. Target = 2%.	1.95%	1.84%	2.53%
Percentage of time network service was available. Target = 99.90%.	99.58%	99.43%	99.69%
Percentage of advanced malware events contained within two business hours. Target = 100%	100%	100%	100%

Use of Funds

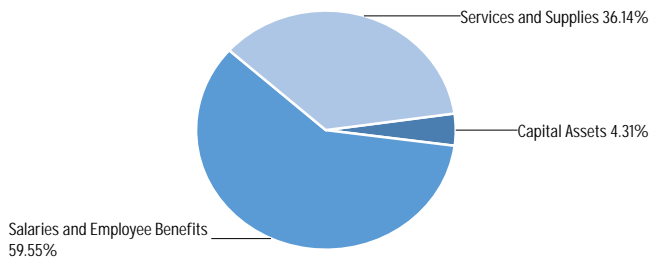

Source of Funds

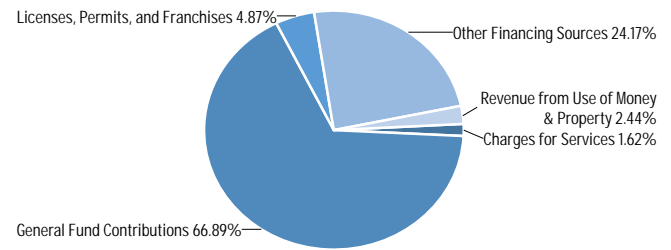

Use of Funds

Expenditures	Prior Year 2021-2022	Adopted Budget 2022-2023	CY Estimate 2022-2023	Requested Budget 2023-2024	Recommended Budget 2023-2024	Recommended Change from Adopted
Salaries and Employee Benefits	\$16,988,034	\$19,788,675	\$18,817,140	\$20,552,362	\$20,552,362	\$763,687
Services and Supplies	\$11,001,881	\$9,898,648	\$9,898,648	\$12,474,223	\$12,474,223	\$2,575,575
Other Charges	\$(35,537,465)	\$(33,438,024)	\$(33,438,024)	\$(28,358,542)	\$(28,358,542)	\$5,079,482
Capital Assets	\$1,046,005	\$3,070,000	\$3,670,000	\$1,488,000	\$1,488,000	\$(1,582,000)
Subtotal	\$(6,501,545)	\$(680,701)	\$(1,052,236)	\$6,156,043	\$6,156,043	\$6,836,744

Source of Funds

Revenues	Prior Year 2021-2022	Adopted Budget 2022-2023	CY Estimate 2022-2023	Requested Budget 2023-2024	Recommended Budget 2023-2024	Recommended Change from Adopted
Licenses, Permits, and Franchises	\$873,915	\$300,000	\$300,000	\$300,000	\$300,000	—
Revenue from Use of Money & Property	\$59,262	\$150,000	\$150,000	\$150,000	\$150,000	—
Charges for Services	\$414,436	\$100,000	\$100,000	\$100,000	\$100,000	—
Other Financing Sources	—	—	—	—	\$1,488,000	\$1,488,000
Subtotal	\$1,347,613	\$550,000	\$550,000	\$550,000	\$2,038,000	\$1,488,000
Fund Balance	—	—	—	\$1,488,000	—	—
General Fund Contributions	\$(7,849,158)	\$(1,230,701)	\$(1,602,236)	\$4,118,043	\$4,118,043	\$5,348,744
Total Source of Funds	\$(6,501,545)	\$(680,701)	\$(1,052,236)	\$6,156,043	\$6,156,043	\$6,836,744

Summary of Recommendation

The Recommended Budget for the Information Technology Department (ITD) is \$6,156,043 in appropriations with total expenditures of \$34,514,585, financed by \$2,038,000 in revenue, \$20,157,907 in cost plan credits, \$8,200,635 in Interfund Reimbursements, and a General Fund Contribution (GFC) of \$4,118,043. The Recommended Budget increases appropriations by \$6,836,744 from the Fiscal Year (FY) 2022-23 Adopted Budget. This increase is primarily due to a shift in the cost plan credit which decreased \$5,090,903. The Recommended Budget includes four augmentations: funding to support use of Countywide Microsoft licensing products and email (\$1,500,000); funding to support connecting and hosting of the Enterprise Resource Planning (ERP) system (\$700,000); and two Capital Improvement Projects (CIP) to support ITD's Data Center System and Countywide Network End of Life Replacement projects (\$1,488,000).

Total operational expenditures budget of \$33,026,585 is an overall increase of \$1,404,262 over FY 2022-23. Salaries and Benefits

increase \$763,687 primarily due to Board of Supervisor approved MOU and benefit changes. Services and Supplies and Other Charges increased a combined \$7.7 million. This increase includes \$2.2 million in operational augmentations, a decrease in the cost plan credit of \$5.1 million, and a roll-over of ARPA expenditures in the amount of \$1,895,333 to complete broadband projects. Capital Assets decrease \$1.6 million mostly due to ARPA expenditures now budgeted under services and supplies. Approved capital asset expenditures for CIP projects of \$1,488,000 are funded by the ITD Assignment Fund Balance. CIP Project expenditures are moved over into Fund 404 as part of the Recommended Budget.

External revenue of \$550,000 is expected to remain status quo. The additional \$1.5 million in revenue is for CIP funded projects.

The FY 2023-24 Recommended Budget includes 110 positions. This includes one additional position added as part of the FY 2022-23 Adopted Budget for the ERP Upgrade project. This additional position has a zero net effect on the ITD budget as the position is covered by ERP project funding.

Budget Impacts

The Recommended Budget reflects a large shift in GFC of \$5.3 million due mainly to the large decrease in the cost plan.

Prior Year Accomplishments

ITD continued recruitment activity in FY 2022-23, filling 7 positions by the third quarter within the 90-day goal. To support a future talent pipeline, ITD partnered with local high schools and colleges to increase awareness of information technology jobs in local government, provide practical guidance and insight to students interested in a career in information technology, and to collaborate with school leadership in offering relevant curriculum to students.

ITD improved first call resolution and customer satisfaction ratings to 75% and 98% respectively; implemented Microsoft Endpoint Manager (MEM) to secure, deploy, and manage users, apps, desktop and mobile devices; worked collaboratively with Human Resources Department (HRD) to deploy the Employee Onboarding module; partnered with departments to develop and execute a Request For Proposal (RFP) to replace the Enterprise Resource Planning (ERP) System; established standardized content and document management systems that align with departmental business operations for efficient storage, retrieval and delivery of documents; streamlined IT Service Management and enhanced user experience with visibility to departments assets and lease information; developed custom technical solutions to improve/automate business processes and expand the use of business intelligence; and established a seamless parcel records management process with cities and agencies.

During 2022, ITD executed agreements with Spectrum and Cruzio Internet for broadband development to extend broadband services in the unserved and underserved areas of Monterey County and expanded public Wi-Fi services around 20 County buildings to support constituent access to the internet. ITD completed multiple infrastructure upgrades to support County operations including: updated and replaced network firewalls throughout the County with standardized configuration and centralized firewall management; completed network micro-segmentation and classification of network traffic and user equipment improving the County's overall network security posture; provided Zoom softphone services to a pilot user group including ITD and multiple DSS branches to enhance remote worker's experience; added 10 Zoom video conferencing rooms; optimized data back-up and recovery platforms to allot for increased data growth from County departments; implemented Multi-Factor Authentication (MFA) to all county users to enhance security and implemented Cloud infrastructure in Azure in preparation of extending the ITD on-premise data center to the cloud for a future hybrid data center solution. ITD completed NGEN phase II upgrade at four NGEN radio sites to double radio channel capacity; completed Inter-RF Subsystem Interface (ISSI) Gateway project to allow NGEN radio system to communicate with FirstNet radios and enhance radio reliability for first responders; expanded radio coverage in the Monterey Peninsula by adding a new radio site around Carmel Highlands area and completed the County-wide microwave upgrade project.

In addition to expanded education efforts, ITD continued to transition technology tools to the cloud that support and protect remote work; completed a third-party review of the County's identity management,

authentication and authorization system and implemented improved security policies and technologies as recommended. ITD completed the County's move to advanced authentication with the goal of eliminating malicious remote takeover of County user accounts. ITD rolled out new defensive tools and technologies to all County systems and added 24x7 operational security monitoring to the environment, significantly decreasing the risk of security breaches.

Budget Year Goals

ITD will recruit and retain a diverse, talented workforce and build a collaborative work environment with an emphasis on customer service and execution to support the mission of Monterey County. In addition, ITD will continue to partner with local educational institutions to support a future talent pipeline of skilled, career ready workers. In FY 2023-24 ITD will improve performance evaluation metrics with a quarterly goal of 100% completion and maintain hiring efficiency with a quarterly goal of 90 days on average.

ITD will continue to improve first call resolution and customer satisfaction ratings; expand the use of MEM to secure, deploy, and manage users, apps, desktop and mobile devices; partner with HRD to deploy the Performance Management module and other technical solutions to increase efficiency and effectiveness of their services; establish vendor agreement for the new Enterprise Resource Planning (ERP) system and implement the Finance module; leverage SharePoint Document Management System (DMS) to digitize departmental paper documents and processes for efficient storage, retrieval and delivery; deploy IT Service Management systems to other county businesses to increase operational efficiency and enhance customer experience; develop custom technical solutions to improve and automate business processes and expand the use of business intelligence; and increase GIS data accuracy by enabling cities and agencies to maintain parcel data and developing integrations with auxiliary systems.

ITD will continue advocating for availability and affordability of broadband services and work with service providers to improve and deploy broadband services in unserved and underserved service areas; complete the Board Chamber technology and broadcasting services upgrade project; upgrade the on-premise data center network; replace end of life and end of support data center systems and begin migrating critical systems to the Cloud to enhance service resiliency and reduce single points of failure and continue to expand and improve the NGEN radio system.

In addition to continued expanded education efforts, ITD will continue to deploy newer defensive technologies, monitoring, and response locally and within the cloud; continue efforts to consolidate and strengthen the County's identity management across all County applications and platforms; and modernize strategies, architectures and technology as the County continues to adopt cloud-based solutions.

Pending Issues

There are no pending issues.

Policy Considerations

There are no policy considerations.

Appropriation Expenditure Detail

	Prior Year 2021-2022	Adopted Budget 2022-2023	CY Estimate 2022-2023	Requested Budget 2023-2024	Recommended Budget 2023-2024	Recommended Change from Adopted	Fund Code	Budget Unit Code
ITD Administration (INF002)	2,097,412	2,481,187	2,318,078	2,637,582	2,637,582	156,395	001	8432
Applications (INF002)	5,239,276	7,089,659	6,281,233	12,511,421	12,511,421	5,421,762	001	8433
Service Delivery (INF002)	4,400,685	0	0	0	0	0	001	8434
Enterprise Operations (INF002)	175,191	0	0	0	0	0	001	8435
Infrastructure (INF002)	6,570,295	10,285,682	10,685,682	13,550,660	13,550,660	3,264,978	001	8436
Security (INF002)	942,450	1,098,275	1,098,275	1,137,534	1,137,534	39,259	001	8437
Information Technology (INF002)	(25,926,854)	(21,635,504)	(21,435,504)	(25,169,154)	(25,169,154)	(3,533,650)	001	8439
IT Capital Projects (INF006)	0	0	0	1,488,000	1,488,000	1,488,000	404	8595
Subtotal	\$(6,501,545)	\$(680,701)	\$(1,052,236)	\$6,156,043	\$6,156,043	\$6,836,744		

Budget Units

	Prior Year 2021-2022	Adopted Budget 2022-2023	CY Estimate 2022-2023	Requested Budget 2023-2024	Recommended Budget 2023-2024	Recommended Change from Adopted
ITD Administration	\$2,097,412	\$2,481,187	\$2,318,078	\$2,637,582	\$2,637,582	\$156,395
Applications	\$5,239,276	\$7,089,659	\$6,281,233	\$12,511,421	\$12,511,421	\$5,421,762
Service Delivery	\$4,400,685	—	—	—	—	—
Enterprise Operations	\$175,191	—	—	—	—	—
Infrastructure	\$6,570,295	\$10,285,682	\$10,685,682	\$13,550,660	\$13,550,660	\$3,264,978
Security	\$942,450	\$1,098,275	\$1,098,275	\$1,137,534	\$1,137,534	\$39,259
Information Technology	\$(25,926,854)	\$(21,635,504)	\$(21,435,504)	\$(25,169,154)	\$(25,169,154)	\$(3,533,650)
IT Capital Projects	—	—	—	\$1,488,000	\$1,488,000	\$1,488,000
Subtotal	\$(6,501,545)	\$(680,701)	\$(1,052,236)	\$6,156,043	\$6,156,043	\$6,836,744

Adopted FY 2022-23 to Recommended FY 2023-24 Positions

Classification Code	Classification Label	Adopted Budget 2021-2022	Adopted Budget 2022-2023	Recommended Budget 2023-2024	Change
12C43	DEPUTY CHIEF INFORMATION OFFICER	2.00	2.00	2.00	0.00
12E18	CHIEF INFORMATION OFFICER	1.00	1.00	1.00	0.00
14B32	SENIOR PERSONNEL ANALYST	1.00	1.00	1.00	0.00
14C30	MANAGEMENT ANALYST II	2.00	2.00	2.00	0.00
14C31	MANAGEMENT ANALYST III	1.00	1.00	1.00	0.00
14H03	PERSONNEL TECHNICIAN-CONFIDENTIAL	1.00	1.00	1.00	0.00
14K52	CHIEF SECURITY OFFICER	1.00	1.00	1.00	0.00
14P20	INFORMATION TECHNOLOGY ARCHITECT	3.00	3.00	3.00	0.00
16C23	INFORMATION TECHNOLOGY SUPERVISOR	0.00	0.00	0.00	0.00
16C43	SOFTWARE ENGINEER I	1.00	1.00	1.00	0.00
16C44	SOFTWARE ENGINEER II	6.00	6.00	6.00	0.00
16C45	SOFTWARE ENGINEER III	17.00	17.00	17.00	0.00
16C54	INFORMATION TECHNOLOGY SYSTEMS ANALYST II	6.00	7.00	8.00	1.00
16C55	INFORMATION TECHNOLOGY SYSTEMS ANALYST III	19.00	19.00	19.00	0.00
16C86	BUSINESS TECHNOLOGY ANALYST I	1.00	0.00	0.00	0.00
16E25	INFORMATION TECHNOLOGY SECURITY ENGINEER III	2.00	2.00	2.00	0.00
16F41	DEPARTMENTAL INFORMATION SYSTEMS MANAGER II	1.00	1.00	0.00	(1.00)

Adopted FY 2022-23 to Recommended FY 2023-24 Positions

Classification Code	Classification Label	Adopted Budget 2021-2022	Adopted Budget 2022-2023	Recommended Budget 2023-2024	Change
16G24	GIS ANALYST II	1.00	1.00	1.00	0.00
16G25	GIS ANALYST III	2.00	2.00	2.00	0.00
20B11	ACCOUNTANT II	1.00	1.00	1.00	0.00
20B93	FINANCE MANAGER II	1.00	1.00	1.00	0.00
41N24	NETWORK SYSTEMS ENGINEER II	4.00	4.00	5.00	1.00
41N25	NETWORK SYSTEMS ENGINEER III	4.00	4.00	4.00	0.00
43A21	ENGINEERING AIDE II	1.00	1.00	1.00	0.00
43G01	INFORMATION TECHNOLOGY MANAGER	8.00	8.00	9.00	1.00
43G03	INFORMATION TECHNOLOGY PROJECT MANAGER II	3.00	3.00	3.00	0.00
43G04	INFORMATION TECHNOLOGY PROJECT MANAGER III	3.00	3.00	3.00	0.00
43J05	DEPARTMENTAL INFORMATION SYSTEMS COORDINATOR	1.00	1.00	0.00	(1.00)
43L41	RADIO COMMUNICATIONS ENGINEER	2.00	2.00	2.00	0.00
43M35	INFORMATION TECHNOLOGY SUPPORT SPECIALIST	7.00	7.00	6.00	(1.00)
70F80	SENIOR STOREKEEPER	1.00	1.00	1.00	0.00
80A99	ADMINISTRATIVE SECRETARY-CONFIDENTIAL	1.00	1.00	1.00	0.00
80E80	PRINCIPAL OFFICE ASSISTANT	2.00	2.00	2.00	0.00
80J30	ACCOUNTING TECHNICIAN	3.00	3.00	3.00	0.00
Total		110.00	110.00	110.00	0.00

Augmentation Requests

Request Code	Request Name	Ranking Type Name	Requested Amount	Requested FTE	Recommended Budget	Recommended FTE
1930-8433-001-AUG2	Advantage	Status Quo Other	700,000	-	700,000	-
1930-8436-001-AUG1	Microsoft	Status Quo Other	1,500,000	-	1,500,000	-
1930-8595-404-CIP46	1930-IT-22-01-ITD Data Center System End of Life Replacement	Capital Improvements	488,000	-	488,000	-
1930-8595-404-CIP48	1930-IT-23-03-County-Wide Network End of Life Replacement	Capital Improvements	1,000,000	-	1,000,000	-
Grand Total:			\$3,688,000	-	\$3,688,000	-

ITD Administration

(Budget Unit 8432—Fund 001—Appropriation Unit INF002)

Use of Funds

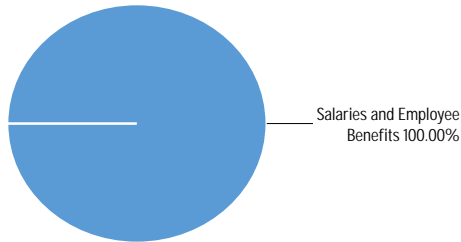

Source of Funds

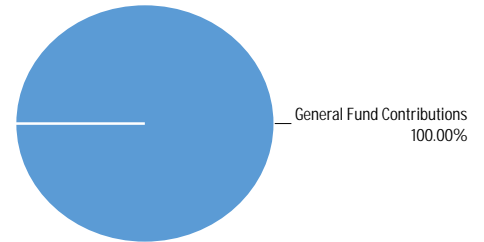

Use of Funds

Expenditures	Prior Year 2021-2022	Adopted Budget 2022-2023	CY Estimate 2022-2023	Requested Budget 2023-2024	Recommended Budget 2023-2024	Recommended Change from Adopted
Salaries and Employee Benefits	\$2,124,891	\$2,676,014	\$2,512,905	\$2,834,188	\$2,834,188	\$158,174
Services and Supplies	\$46,474	—	—	\$2,170	\$2,170	\$2,170
Other Charges	\$(73,953)	\$(194,827)	\$(194,827)	\$(198,776)	\$(198,776)	\$(3,949)
Subtotal	\$2,097,412	\$2,481,187	\$2,318,078	\$2,637,582	\$2,637,582	\$156,395

Source of Funds

Revenues	Prior Year 2021-2022	Adopted Budget 2022-2023	CY Estimate 2022-2023	Requested Budget 2023-2024	Recommended Budget 2023-2024	Recommended Change from Adopted
General Fund Contributions	\$2,097,412	\$2,481,187	\$2,318,078	\$2,637,582	\$2,637,582	\$156,395
Total Source of Funds	\$2,097,412	\$2,481,187	\$2,318,078	\$2,637,582	\$2,637,582	\$156,395

Unit Description

The Administration Division is comprised of Fiscal, Human Resources Management, Project Management and Contracts Management.

Fiscal is responsible for oversight of department finances which include budget preparation, tracking of actual transactions, and financial forecasting as it relates to both internal department and customer charges. Capital infrastructure needs and asset tracking are also under this section of ITD.

Human Resources partners and collaborates with ITD management to provide diverse talent management & recruitment services; the development and retention of staff; and other HR support services such as benefit coordination.

Project Management provides project and portfolio for all large scale, multi-disciplined IT infrastructure and application projects. Project Management Office (PMO) guides projects through the complete project management lifecycle utilizing best practices, and develops tools/processes to foster consistent, repeatable and measurable project outcomes.

Contracts Management is responsible for processing all contracts and agreements, fleet management, facilities management and oversees cable and franchise programs.

Recommended FY 2023-24 Positions

Classification Code	Classification Label	FTE
14B32	SENIOR PERSONNEL ANALYST	1.00
14C30	MANAGEMENT ANALYST II	2.00
14C31	MANAGEMENT ANALYST III	1.00
14H03	PERSONNEL TECHNICIAN-CONFIDENTIAL	1.00
20B11	ACCOUNTANT II	1.00
20B93	FINANCE MANAGER II	1.00
43G03	INFORMATION TECHNOLOGY PROJECT MANAGER II	3.00
43G04	INFORMATION TECHNOLOGY PROJECT MANAGER III	3.00
80J30	ACCOUNTING TECHNICIAN	3.00
Total		16.00

Applications

(Budget Unit 8433—Fund 001—Appropriation Unit INF002)

Use of Funds

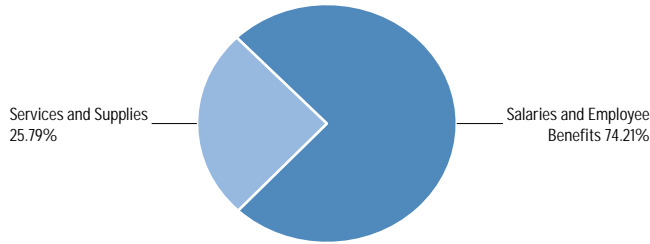

Source of Funds

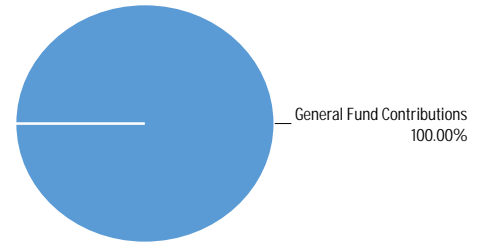

Use of Funds

Expenditures	Prior Year 2021-2022	Adopted Budget 2022-2023	CY Estimate 2022-2023	Requested Budget 2023-2024	Recommended Budget 2023-2024	Recommended Change from Adopted
Salaries and Employee Benefits	\$5,498,557	\$9,015,173	\$8,206,747	\$9,284,675	\$9,284,675	\$269,502
Services and Supplies	\$2,733,764	\$3,205,577	\$3,205,577	\$3,226,746	\$3,226,746	\$21,169
Other Charges	\$(2,993,045)	\$(5,131,091)	\$(5,131,091)	—	—	\$5,131,091
Subtotal	\$5,239,276	\$7,089,659	\$6,281,233	\$12,511,421	\$12,511,421	\$5,421,762

Source of Funds

Revenues	Prior Year 2021-2022	Adopted Budget 2022-2023	CY Estimate 2022-2023	Requested Budget 2023-2024	Recommended Budget 2023-2024	Recommended Change from Adopted
Charges for Services	\$819	—	—	—	—	—
Subtotal	\$819	—	—	—	—	—
General Fund Contributions	\$5,238,457	\$7,089,659	\$6,281,233	\$12,511,421	\$12,511,421	\$5,421,762
Total Source of Funds	\$5,239,276	\$7,089,659	\$6,281,233	\$12,511,421	\$12,511,421	\$5,421,762

Unit Description

The Applications and Customer Support Division is comprised of Enterprise Applications, Web Services, GIS Services, and Department Applications and Customer Support. Enterprise Applications provides database administration, software programming, systems consulting, project management and application administration support for enterprise applications for collaboration, document and records management, data integration warehousing and management, business intelligence and analysis, as well as interdepartmental billing and reporting of ITD services. Web Services provides development and maintenance of Monterey County's internal and external website, individual Department sites, as well as graphic services and consulting and training services on the tools and techniques for content management, website quality assurance, and web analytics and reporting. GIS Services provides GIS analytical services and development and maintenance of Monterey County's Geo Database, including the development of additional layers of specific GIS data and map development for internal and external customers.

Department Applications Support provides database administration, software programming, systems consulting, project management and application administration support services for applications specific to individual County departments. Customer Support offers a portfolio of IT services that includes desktop management, service desk, and data center services. These complementary services provide fundamental information technology capabilities vital to our customers. IT Service Desk serves as a single point-of-contact for requesting IT services, technical support and the dissemination of IT systems status and availability information. Desktop Management provides PC lifecycle management including the planning, acquisition, installation, support, maintenance and replacement of PC-based hardware and software. IT Procurement is responsible for providing logistical support and sourcing for IT related goods and services to all County agencies and operating the County's central IT Warehouse facility. In addition, this group oversees the functionality of IT facilities, including backup generators, HVAC, and UPS systems.

Recommended FY 2023-24 Positions

Classification Code	Classification Label	FTE
12C43	DEPUTY CHIEF INFORMATION OFFICER	1.00
14P20	INFORMATION TECHNOLOGY ARCHITECT	1.00
16C43	SOFTWARE ENGINEER I	1.00
16C44	SOFTWARE ENGINEER II	6.00
16C45	SOFTWARE ENGINEER III	17.00
16C54	INFORMATION TECHNOLOGY SYSTEMS ANALYST II	7.00

Recommended FY 2023-24 Positions

Classification Code	Classification Label	FTE
16C55	INFORMATION TECHNOLOGY SYSTEMS ANALYST III	8.00
16G24	GIS ANALYST II	1.00
16G25	GIS ANALYST III	2.00
43G01	INFORMATION TECHNOLOGY MANAGER	5.00
43M35	INFORMATION TECHNOLOGY SUPPORT SPECIALIST	2.00
70F80	SENIOR STOREKEEPER	1.00
Total		52.00

Service Delivery

(Budget Unit 8434—Fund 001—Appropriation Unit INF002)

Use of Funds

Intentionally Left Blank

Source of Funds

Intentionally Left Blank

Use of Funds

Expenditures	Prior Year 2021-2022	Adopted Budget 2022-2023	CY Estimate 2022-2023	Requested Budget 2023-2024	Recommended Budget 2023-2024	Recommended Change from Adopted
Salaries and Employee Benefits	\$3,939,259	—	—	—	—	—
Services and Supplies	\$1,837,410	—	—	—	—	—
Other Charges	\$(1,393,346)	—	—	—	—	—
Capital Assets	\$17,363	—	—	—	—	—
Subtotal	\$4,400,685	—	—	—	—	—

Source of Funds

Revenues	Prior Year 2021-2022	Adopted Budget 2022-2023	CY Estimate 2022-2023	Requested Budget 2023-2024	Recommended Budget 2023-2024	Recommended Change from Adopted
Charges for Services	\$74,404	—	—	—	—	—
Subtotal	\$74,404	—	—	—	—	—
General Fund Contributions	\$4,326,282	—	—	—	—	—
Total Source of Funds	\$4,400,685	—	—	—	—	—

Unit Description

Department has discontinued use of this Unit. Staff and duties have been split between Units 8433 and 8436.

Infrastructure

(Budget Unit 8436—Fund 001—Appropriation Unit INF002)

Use of Funds

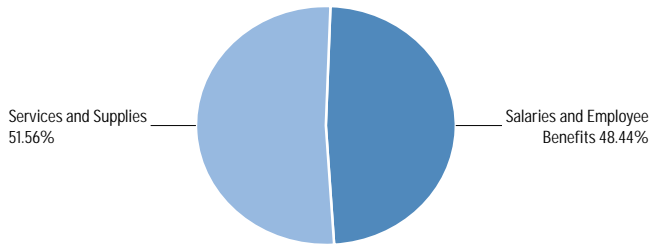

Source of Funds

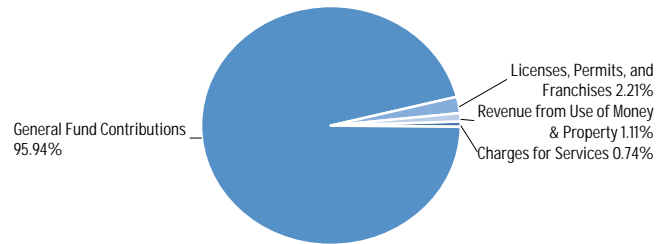

Use of Funds

Expenditures	Prior Year 2021-2022	Adopted Budget 2022-2023	CY Estimate 2022-2023	Requested Budget 2023-2024	Recommended Budget 2023-2024	Recommended Change from Adopted
Salaries and Employee Benefits	\$3,958,761	\$6,181,200	\$6,181,200	\$6,563,720	\$6,563,720	\$382,520
Services and Supplies	\$4,190,325	\$4,447,778	\$4,447,778	\$6,986,940	\$6,986,940	\$2,539,162
Other Charges	\$(2,351,339)	\$(2,863,296)	\$(2,863,296)	—	—	\$2,863,296
Capital Assets	\$772,548	\$2,520,000	\$2,920,000	—	—	\$(2,520,000)
Subtotal	\$6,570,295	\$10,285,682	\$10,685,682	\$13,550,660	\$13,550,660	\$3,264,978

Source of Funds

Revenues	Prior Year 2021-2022	Adopted Budget 2022-2023	CY Estimate 2022-2023	Requested Budget 2023-2024	Recommended Budget 2023-2024	Recommended Change from Adopted
Licenses, Permits, and Franchises	\$873,915	\$300,000	\$300,000	\$300,000	\$300,000	—
Revenue from Use of Money & Property	\$59,262	\$150,000	\$150,000	\$150,000	\$150,000	—
Charges for Services	\$410,647	\$100,000	\$100,000	\$100,000	\$100,000	—
Subtotal	\$1,343,824	\$550,000	\$550,000	\$550,000	\$550,000	—
General Fund Contributions	\$5,226,471	\$9,735,682	\$10,135,682	\$13,000,660	\$13,000,660	\$3,264,978
Total Source of Funds	\$6,570,295	\$10,285,682	\$10,685,682	\$13,550,660	\$13,550,660	\$3,264,978

Unit Description

The Infrastructure and Operations Division is comprised of Network Services, Systems and Operations, Unified Communication and Collaboration and Radio Communications. This division provides critical technology capabilities essential for County’s business needs, which include network, voice, video, data center, public safety radio and microwave services.

Network Services is responsible for building and supporting a secure, reliable, and scalable local and wide area network. It offers an IP (Internet Protocol) converged platform to support existing and emerging technologies.

Unified Communication and Collaboration provides voice and video collaboration services and support for County Board of Supervisors meetings and broadcasting services.

Systems and Operations provides support and maintenance of the County’s on-premise and cloud-based data center and systems including servers, storage, data backup and restore, and critical systems support.

Radio Communications provides end-to-end radio services, radio tower and site management, and microwave backhaul services with a focus on serving regional public safety agencies

Recommended FY 2023-24 Positions

Classification Code	Classification Label	FTE
12C43	DEPUTY CHIEF INFORMATION OFFICER	1.00
14P20	INFORMATION TECHNOLOGY ARCHITECT	2.00
16C54	INFORMATION TECHNOLOGY SYSTEMS ANALYST II	1.00
16C55	INFORMATION TECHNOLOGY SYSTEMS ANALYST III	11.00
41N24	NETWORK SERVICES ENGINEER II	5.00

Recommended FY 2023-24 Positions

Classification Code	Classification Label	FTE
41N25	NETWORK SERVICES ENGINEER III	4.00
43A21	ENGINEERING AIDE II	1.00
43G01	INFORMATION TECHNOLOGY MANAGER	4.00
43L41	RADIO COMMUNICATIONS ENGINEER	2.00
43M35	INFORMATION TECHNOLOGY SUPPORT SPECIALIST	4.00
Total		35.00

Security

(Budget Unit 8437—Fund 001—Appropriation Unit INF002)

Use of Funds

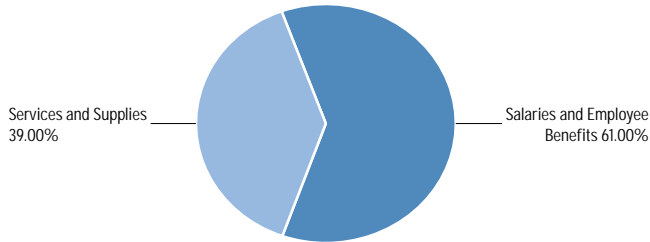

Source of Funds

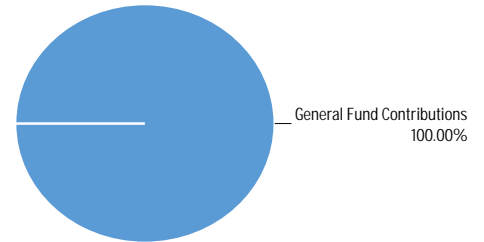

Use of Funds

Expenditures	Prior Year 2021-2022	Adopted Budget 2022-2023	CY Estimate 2022-2023	Requested Budget 2023-2024	Recommended Budget 2023-2024	Recommended Change from Adopted
Salaries and Employee Benefits	\$563,831	\$655,076	\$655,076	\$693,928	\$693,928	\$38,852
Services and Supplies	\$378,620	\$443,199	\$443,199	\$443,606	\$443,606	\$407
Subtotal	\$942,450	\$1,098,275	\$1,098,275	\$1,137,534	\$1,137,534	\$39,259

Source of Funds

Revenues	Prior Year 2021-2022	Adopted Budget 2022-2023	CY Estimate 2022-2023	Requested Budget 2023-2024	Recommended Budget 2023-2024	Recommended Change from Adopted
General Fund Contributions	\$942,450	\$1,098,275	\$1,098,275	\$1,137,534	\$1,137,534	\$39,259
Total Source of Funds	\$942,450	\$1,098,275	\$1,098,275	\$1,137,534	\$1,137,534	\$39,259

Unit Description

Information Security assists County business with assuring the availability of their information by guiding County businesses in how to properly manage the security risks to their information assets, actively monitoring those assets for compromise, and leading the effective business recovery of information assets that have been compromised.

Recommended FY 2023-24 Positions

Classification Code	Classification Label	FTE
14K52	CHIEF SECURITY OFFICER	1.00
16E25	INFORMATION TECHNOLOGY SECURITY ENGINEER III	2.00
Total		3.00

Information Technology

(Budget Unit 8439—Fund 001—Appropriation Unit INF002)

Use of Funds

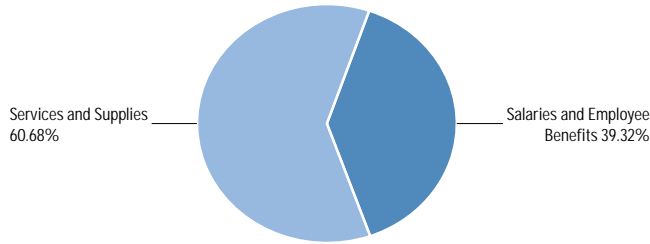

Source of Funds

Intentionally Left Blank

Use of Funds

Expenditures	Prior Year 2021-2022	Adopted Budget 2022-2023	CY Estimate 2022-2023	Requested Budget 2023-2024	Recommended Budget 2023-2024	Recommended Change from Adopted
Salaries and Employee Benefits	\$897,605	\$1,261,212	\$1,261,212	\$1,175,851	\$1,175,851	\$(85,361)
Services and Supplies	\$1,645,228	\$1,802,094	\$1,802,094	\$1,814,761	\$1,814,761	\$12,667
Other Charges	\$(28,725,782)	\$(25,248,810)	\$(25,248,810)	\$(28,159,766)	\$(28,159,766)	\$(2,910,956)
Capital Assets	\$256,095	\$550,000	\$750,000	—	—	\$(550,000)
Subtotal	\$(25,926,854)	\$(21,635,504)	\$(21,435,504)	\$(25,169,154)	\$(25,169,154)	\$(3,533,650)

Source of Funds

Revenues	Prior Year 2021-2022	Adopted Budget 2022-2023	CY Estimate 2022-2023	Requested Budget 2023-2024	Recommended Budget 2023-2024	Recommended Change from Adopted
Charges for Services	\$(71,433)	—	—	—	—	—
Subtotal	\$(71,433)	—	—	—	—	—
General Fund Contributions	\$(25,855,421)	\$(21,635,504)	\$(21,435,504)	\$(25,169,154)	\$(25,169,154)	\$(3,533,650)
Total Source of Funds	\$(25,926,854)	\$(21,635,504)	\$(21,435,504)	\$(25,169,154)	\$(25,169,154)	\$(3,533,650)

Unit Description

The ITD Unit is in place to account for costs not directly related to any of the other specific Organizational Units. Executive management costs are captured here, as well as certain facility expenses.

Recommended FY 2023-24 Positions

Classification Code	Classification Label	FTE
12E18	CHIEF INFORMATION OFFICER	1.00
80A99	ADMINISTRATIVE SECRETARY- CONFIDENTIAL	1.00
80E80	PRINCIPAL OFFICE ASSISTANT	2.00
Total		4.00

IT Capital Projects

(Budget Unit 8595—Fund 404—Appropriation Unit INF006)

Use of Funds

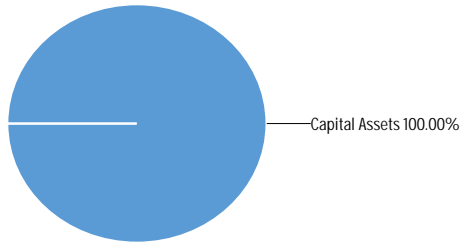

Source of Funds

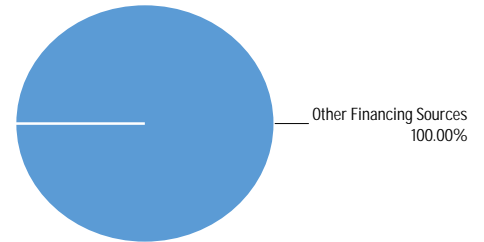

Use of Funds

Expenditures	Prior Year 2021-2022	Adopted Budget 2022-2023	CY Estimate 2022-2023	Requested Budget 2023-2024	Recommended Budget 2023-2024	Recommended Change from Adopted
Capital Assets	-	-	-	\$1,488,000	\$1,488,000	\$1,488,000
Subtotal	-	-	-	\$1,488,000	\$1,488,000	\$1,488,000

Source of Funds

Revenues	Prior Year 2021-2022	Adopted Budget 2022-2023	CY Estimate 2022-2023	Requested Budget 2023-2024	Recommended Budget 2023-2024	Recommended Change from Adopted
Other Financing Sources	-	-	-	-	\$1,488,000	\$1,488,000
Subtotal	-	-	-	-	\$1,488,000	\$1,488,000
Fund Balance	-	-	-	\$1,488,000	-	-
General Fund Contributions	-	-	-	-	-	-
Total Source of Funds	-	-	-	\$1,488,000	\$1,488,000	\$1,488,000

Unit Description

The ITD Capital Projects (404) unit was created in FY 2023-24 to track and manage ITD Capital Improvement Projects (CIP) funded by the ITD assignment.



This page intentionally left blank.

District Attorney

Departmental Overview:

Under the leadership of District Attorney Jeannine M. Pacioni, the District Attorney's Office attends the courts and conducts all local criminal prosecutions as required by Government Code Section 26500. The District Attorney is a State Constitutional Officer when prosecuting crimes defined under State law. The Office of the District Attorney consists of attorneys, investigators, legal support staff and victim advocates. The Office engages in community and multi-agency projects which protect public safety and provides legal advice to all law enforcement agencies and training programs for their personnel. These programs increase the probability of successful prosecutions.

Programs and Functions:

TRUANCY ABATEMENT PROGRAM: Increased individual mediation hearings at school sites have resulted in a positive outcome with the vast majority of students improving regular attendance and obtaining resources and referrals to appropriate programs. This collaboration has resulted in increased high school graduations and decreased drop-out rates compared to statewide rates.

CRIMINAL UNIT: County discretionary revenues fund approximately 55% of core functions, including prosecution of crimes such as murder, sexual assault, gang crimes, robbery, burglary, felony assault, felony theft, juvenile crimes and all misdemeanor crimes. Grants fund another 45% of activities, including the civil and environmental unit, various types of specialty fraud prosecutions, and crimes committed in local prisons. The Office reviews over 15,000 cases for filing per year.

CIVIL UNIT: To protect Monterey County consumers, the Consumer Protection Unit handles both civil and criminal enforcement in cases involving fraudulent business practices. The Environmental Protection Unit enforces laws to protect the health of the community from pollution. The Cannabis Prosecution Unit enforces State and local regulations to ensure a level playing field within the industry and to protect legitimate businesses from competition from illegal cannabis.

KING CITY FAMILY JUSTICE CENTER: Victims of crime and their families can access services in Spanish in South County. The Family Justice Center serves survivors of domestic violence, sexual assault, human trafficking, child abuse, and their children. Other co-located, multidisciplinary models offer flexible, holistic additional services.

The Department's Contribution to Monterey County's Strategic Initiatives:

ADMINISTRATION:

The Office of the District Attorney is one of the most financially efficient Offices in the State, having a unit cost per case almost half the State average.

HEALTH AND HUMAN SERVICES:

The Office of the District Attorney ensures the highest quality of life in the County through environmental law enforcement.

PUBLIC SAFETY:

The Office promotes justice, ensuring that the rights of victims are upheld by treating them with dignity, respect and compassion. The Office aggressively and fairly prosecutes those who violate the law.



Operating Budget: \$41,454,016
Positions (FTEs): 160.00

Jeannine M. Pacioni
District Attorney

Civil

Criminal

Staffing Trends

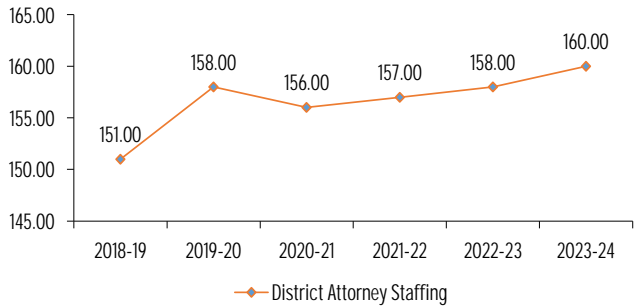

Expenditure/Revenue History (in millions)

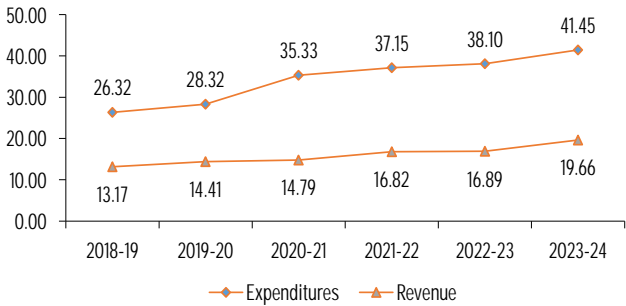

The improved drop-out rates of Monterey County demonstrate our improvements in case management. Some of our schools use a GPA of 1.0 to graduate, state govt uses 2.0. The pandemic affected truancy measures. The net County cost per case remains lower than statewide averages, demonstrating efficiency compared to other DA offices.

Key Performance Measures	2020-21 Actual	2021-22 Actual	2022-23 Mid-Year
Truancy: Number of active cases monitored.	6,830	7,411	8,922
Truancy: Monterey County graduation rate.	85%	86%	N/A
Truancy: California graduation rate.	83.6%	87.4%	N/A
Truancy: California drop-out rate.	8.9%	N/A	N/A
Efficiency: District Attorney net County cost per case filed with courts.	\$1,492	N/A	N/A
Efficiency: California Counties (other DAs) net county cost per case with courts.	\$1,989	N/A	N/A

Use of Funds

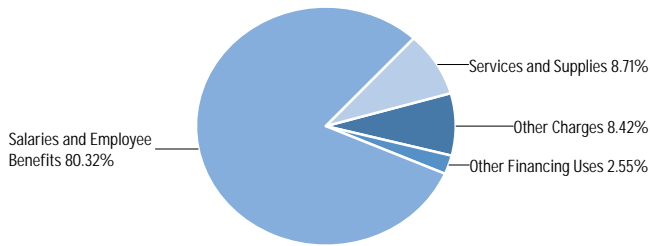

Source of Funds

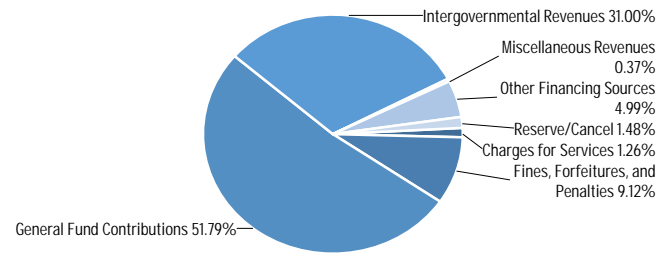

Use of Funds

Expenditures	Prior Year 2021-2022	Adopted Budget 2022-2023	CY Estimate 2022-2023	Requested Budget 2023-2024	Recommended Budget 2023-2024	Recommended Change from Adopted
Salaries and Employee Benefits	\$26,047,482	\$30,970,740	\$28,573,430	\$33,293,310	\$33,273,245	\$2,302,505
Services and Supplies	\$3,753,611	\$3,899,438	\$4,180,403	\$4,900,672	\$3,606,672	\$(292,766)
Other Charges	\$6,764,417	\$4,315,862	\$4,451,528	\$3,489,099	\$3,489,099	\$(826,763)
Capital Assets	—	\$60,000	\$62,186	\$30,000	\$30,000	\$(30,000)
Other Financing Uses	\$583,955	\$831,413	\$831,413	\$1,055,000	\$1,055,000	\$223,587
Subtotal	\$37,149,466	\$40,077,453	\$38,098,960	\$42,768,081	\$41,454,016	\$1,376,563

Source of Funds

Revenues	Prior Year 2021-2022	Adopted Budget 2022-2023	CY Estimate 2022-2023	Requested Budget 2023-2024	Recommended Budget 2023-2024	Recommended Change from Adopted
Fines, Forfeitures, and Penalties	\$3,319,006	\$3,909,913	\$2,086,776	\$3,836,529	\$3,836,529	\$(73,384)
Revenue from Use of Money & Property	\$112	\$100	\$122	\$108	\$108	\$8
Intergovernmental Revenues	\$11,426,326	\$12,570,249	\$12,270,405	\$13,043,246	\$13,043,246	\$472,997
Charges for Services	\$544,218	\$686,489	\$293,150	\$528,484	\$528,484	\$(158,005)
Miscellaneous Revenues	\$101,200	\$142,400	\$177,760	\$155,548	\$155,548	\$13,148
Other Financing Sources	\$1,433,280	\$1,680,237	\$2,065,249	\$2,097,633	\$2,097,633	\$417,396
Subtotal	\$16,824,142	\$18,989,388	\$16,893,462	\$19,661,548	\$19,661,548	\$672,160
General Fund Contributions	\$20,325,324	\$21,088,065	\$21,205,498	\$22,485,734	\$21,171,669	\$83,604
General Fund - Restricted Fund Balance	—	—	—	\$620,799	\$620,799	\$620,799
Total Source of Funds	\$37,149,466	\$40,077,453	\$38,098,960	\$42,768,081	\$41,454,016	\$1,376,563

Summary of Recommendation

The Recommended Budget for the Office of the District Attorney is \$41,454,016 financed by \$19,661,548 in revenue, a General Fund Contribution (GFC) of \$21,171,669 and \$620,799 in departmental restricted revenues. The Recommended Budget reflects an overall increase of \$1,376,563, for cost of living increases for staff, higher, pension, insurance and worker's compensation costs.

Budget Impacts

The Recommended Budget allows the Office to maintain current levels of service and adds \$100,325 for a new Departmental Information Systems Coordinator and 160 positions total.

During the current fiscal year, the department was also able to add a new Victim Witness Program Coordinator to the Family Justice

Center with funding from the Kaiser Foundation and reinstate a Chief Deputy District Attorney position.

Prior Year Accomplishments

The Criminal Unit successfully prosecuted many high-profile cases during the year, including murder, gang crimes and public integrity prosecutions.

The Civil Unit received settlements averaging more than \$2.42 million per year between 2017 and 2021, which protects consumers and the environment and combats unfair competition.

The Workers Compensation Fraud Unit continued its efforts to protect workers from unscrupulous employers who do not purchase mandatory insurance and to target employees who commit applicant fraud.

Odie and Norma Jean, the Office’s facility dogs, continue to assist child and adult victims in their time of need as they navigate our court system.

The Cannabis Unit improved enforcement capabilities in a rapidly expanding commercial sector. During 2022, the team assisted in identifying and eradicating 62 tons of unlicensed cannabis, 33 tons of unlicensed processed cannabis flower and 20 pounds of unlicensed cannabis concentrate. Additionally, criminal prosecutions included environmental felonies, armed robbery, embezzlement, possession of illegal assault rifles, illegal explosives, money laundering, tax evasion and workers compensation fraud.

Budget Year Goals

To closely monitor the financial status of the department throughout the year and identify financial challenges, including possible salary increases, which call for vigilance and financial flexibility. The Family Justice Center is planned to begin operations in July 2023. Future plans include creating additional centers in Salinas and Seaside.

Pending Issues

EDD INVESTIGATION: The Office and State investigators and prison staff are coordinating prosecution related to fraudulent claims filed by members of the public with the Employment Development Department, including local prisons and the local jail. This fraud targeted pandemic stimulus employment funds.

FILELESS OPERATIONS: New cases are electronically filed with the courts and local law enforcement agencies are transitioning to electronic filing to eliminate paper files in the future. Furthermore, Office staff are digitizing and destroying unneeded files to reduce storage costs and leverage the existing case management system.

DIGITAL EVIDENCE: The Office continues to seek solutions to process a higher level of digital evidence resulting from law enforcement’s increasing use of body cameras and the increased prevalence of surveillance video. Processing and providing this evidence to defense counsel are challenges for District Attorney Offices statewide.

CRIMINAL JUSTICE REFORM: The legislature continues to pass many criminal justice reform measures that apply retroactively to cases already adjudicated, creating unfunded State mandates that result in higher workloads absorbed by existing staff. Most frequently, the District Attorney receives petitions from defendants requesting relief who are not eligible under the law and the Office must demonstrate ineligibility to the court which requires time and effort. Other times relief requires litigation to determine whether the new law applies to a defendant.

MARIJUANA LEGALIZATION: Creation of the Cannabis Unit significantly improved capabilities to enforce new laws in this rapidly expanding commercial sector. This unit exists to enforce the regulatory vision enacted by the Board of Supervisors and the State.

Policy Considerations

There are no policy considerations.

Appropriation Expenditure Detail

	Prior Year 2021-2022	Adopted Budget 2022-2023	CY Estimate 2022-2023	Requested Budget 2023-2024	Recommended Budget 2023-2024	Recommended Change from Adopted	Fund Code	Budget Unit Code
Civil (DIS001)	4,272,422	5,422,539	4,193,348	5,533,705	5,533,705	111,166	001	8062
Criminal (DIS001)	32,293,089	33,456,309	32,768,807	35,713,351	34,399,286	942,977	001	8063
Criminal (DIS002)	583,955	831,413	831,413	1,055,000	1,055,000	223,587	022	8063
King City (DIS001)	0	367,192	305,392	466,025	466,025	98,833	001	8573
Subtotal	37,149,466	40,077,453	38,098,960	42,768,081	41,454,016	1,376,563		

Budget Units

	Prior Year 2021-2022	Adopted Budget 2022-2023	CY Estimate 2022-2023	Requested Budget 2023-2024	Recommended Budget 2023-2024	Recommended Change from Adopted
Civil	\$4,272,422	\$5,422,539	\$4,193,348	\$5,533,705	5,533,705	\$111,166
Criminal	\$32,877,044	\$34,287,722	\$33,600,220	\$36,768,351	35,454,286	\$1,166,564
King City	—	\$367,192	\$305,392	\$466,025	466,025	\$98,833
Subtotal	\$37,149,466	\$40,077,453	\$38,098,960	\$42,768,081	41,454,016	\$1,376,563

Adopted FY 2022-23 to Recommended FY 2023-24 Positions

Classification Code	Classification Label	Adopted Budget 2021-2022	Adopted Budget 2022-2023	Recommended Budget 2023-2024	Change
10B04	DISTRICT ATTORNEY	1.00	1.00	1.00	0.00
12A03	CHIEF ASSISTANT DISTRICT ATTORNEY	1.00	1.00	1.00	0.00
12A04	ASSISTANT DISTRICT ATTORNEY	3.00	4.00	4.00	0.00
14C30	MANAGEMENT ANALYST II	1.00	1.00	1.00	0.00
14C70	ADMINISTRATIVE SERVICES ASSISTANT	0.00	0.00	1.00	1.00
14C75	ADMINISTRATIVE ASSISTANT TO DISTRCT ATTORNEY	1.00	1.00	1.00	0.00
14C87	VICTIM/WITNESS ASSISTANCE PROGRAM MANAGER	1.00	1.00	1.00	0.00
14K60	CHIEF DISTRICT ATTORNEY INVESTIGATOR	1.00	1.00	1.00	0.00
20B10	ACCOUNTANT I	1.00	1.00	1.00	0.00
20B11	ACCOUNTANT II	1.00	1.00	1.00	0.00
20B12	ACCOUNTANT III	2.00	2.00	2.00	0.00
20B93	FINANCE MANAGER II	1.00	1.00	1.00	0.00
34A20	DISTRICT ATTORNEY INVESTIGATOR I	5.00	5.00	5.00	0.00
34A22	DISTRICT ATTORNEY INVESTIGATOR III	21.00	21.00	21.00	0.00
34A80	DISTRICT ATTORNEY INVESTIGATIVE CAPTAIN	2.00	2.00	2.00	0.00
34G10	INVESTIGATIVE AIDE	6.00	6.00	6.00	0.00
39C01	LEGAL ASSISTANT	4.00	4.00	4.00	0.00
39D31	DEPUTY DISTRICT ATTORNEY IV	54.00	55.00	54.00	(1.00)
39D32	CHIEF DEPUTY DISTRICT ATTORNEY	1.00	0.00	1.00	1.00
43G05	DIGITAL FORENSIC INVESTIGATOR	1.00	1.00	1.00	0.00
43J05	DEPARTMENTAL INFORMATION SYSTEMS COORDINATOR	0.00	0.00	1.00	1.00
60K02	VICTIM ASSISTANCE ADVOCATE	10.00	10.00	10.00	0.00
60K03	VICTIM/WITNESS ASSISTANCE PROGRAM COORDINATOR	1.00	1.00	2.00	1.00
80B11	LEGAL TYPIST	7.00	7.00	7.00	0.00
80B22	LEGAL SECRETARY II	28.00	28.00	24.00	(4.00)
80B24	SUPERVISING LEGAL SECRETARY	3.00	3.00	3.00	0.00
80B26	LEGAL SECRETARY III	0.00	0.00	3.00	3.00
Total		157.00	158.00	160.00	2.00

District Attorney

Augmentation Requests

Request Code	Request Name	Ranking Type Name	Requested Amount	Requested FTE	Recommended Budget	Recommended FTE
2240-8063-001-AUG1	Dept Info Systems Coordinator	Request New Position	120,390	1.00	100,325	1.00
2240-8063-001-AUG2	Digital File Conversion-Phase 1	New Program/Service w/ General Fund Funding	94,000	-	-	-
2240-8063-001-AUG3	Digital File Conversion-Phase 2	New Program/Service w/ General Fund Funding	1,200,000	-	-	-
Grand Total:			\$1,414,390	1.00	\$100,325	1.00

Civil

(Budget Unit 8062—Fund 001—Appropriation Unit DIS001)

Use of Funds

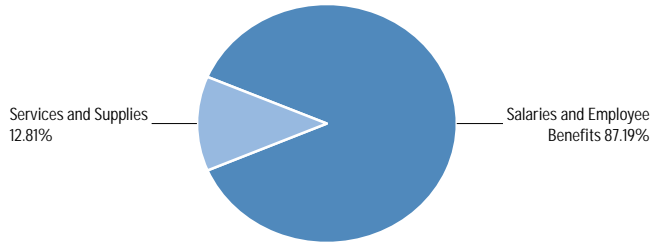

Source of Funds

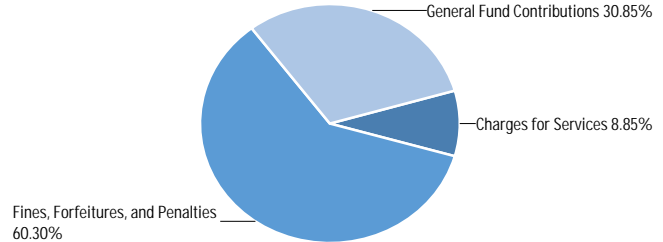

Use of Funds

Expenditures	Prior Year 2021-2022	Adopted Budget 2022-2023	CY Estimate 2022-2023	Requested Budget 2023-2024	Recommended Budget 2023-2024	Recommended Change from Adopted
Salaries and Employee Benefits	\$3,464,543	\$4,753,882	\$3,460,364	\$4,877,031	\$4,877,031	\$123,149
Services and Supplies	\$641,119	\$698,657	\$762,984	\$716,674	\$716,674	\$18,017
Other Charges	\$166,761	\$(60,000)	\$(60,000)	\$(60,000)	\$(60,000)	—
Capital Assets	—	\$30,000	\$30,000	—	—	\$(30,000)
Subtotal	\$4,272,422	\$5,422,539	\$4,193,348	\$5,533,705	\$5,533,705	\$111,166

Source of Funds

Revenues	Prior Year 2021-2022	Adopted Budget 2022-2023	CY Estimate 2022-2023	Requested Budget 2023-2024	Recommended Budget 2023-2024	Recommended Change from Adopted
Fines, Forfeitures, and Penalties	\$2,823,688	\$3,264,256	\$1,201,596	\$3,336,694	\$3,336,694	\$72,438
Charges for Services	\$488,422	\$631,229	\$266,347	\$490,000	\$490,000	\$(141,229)
Subtotal	\$3,312,110	\$3,895,485	\$1,467,943	\$3,826,694	\$3,826,694	\$(68,791)
General Fund Contributions	\$960,312	\$1,527,054	\$2,725,405	\$1,386,212	\$1,386,212	\$(140,255)
Restricted Fund Balance	—	—	—	\$320,799	\$320,799	\$320,799
Total Source of Funds	\$4,272,422	\$5,422,539	\$4,193,348	\$5,533,705	\$5,533,705	\$111,166

Unit Description

To protect Monterey County consumers, the Consumer Protection Unit handles both civil and criminal enforcement including cases involving unfair business practices and false advertising; fraud in telemarketing and mail solicitation; price gouging; pyramid schemes; real estate and mortgage fraud; fraudulent investment transactions, securities drug and healthcare claims, warranties, sweepstakes, insurance packing, internet auctions and purchases, and schemes targeting senior citizens or immigrant communities.

The Environmental Protection Unit enforces laws to protect our local environment. Cases involve hazardous material and hazardous waste violations, pollution, and other areas that impact the health of our community. The successful conclusion of consumer and environmental cases often involve collaboration with multiple agencies or counties throughout the State.

The Cannabis Prosecution Unit enforces State and local regulations to ensure a level playing field and protect the industry from competition

from illegal cannabis. These regulations protect consumers, the environment, and revenue.

Recommended FY 2023-24 Positions

Classification Code	Classification Label	FTE
12A04	ASSISTANT DISTRICT ATTORNEY	1.00
20B12	ACCOUNTANT III	2.00
34A22	DISTRICT ATTORNEY INVESTIGATOR III	6.00
34A80	DISTRICT ATTORNEY INVESTIGATIVE CAPTAIN	1.00
39C01	LEGAL ASSISTANT	1.00
39D31	DEPUTY DISTRICT ATTORNEY IV	6.00
39D32	CHIEF DEPUTY DISTRICT ATTORNEY	1.00
80B22	LEGAL SECRETARY II	2.00
Total		20.00

Criminal

(Budget Unit 8063—Fund 001—Appropriation Unit DIS001)

Use of Funds

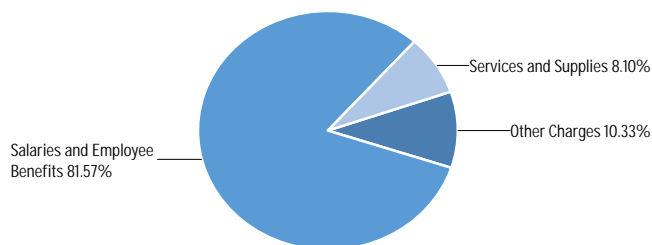

Source of Funds

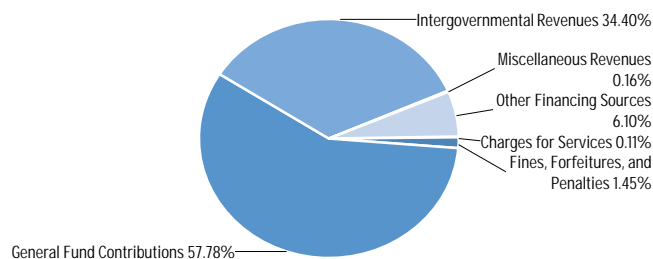

Use of Funds

Expenditures	Prior Year 2021-2022	Adopted Budget 2022-2023	CY Estimate 2022-2023	Requested Budget 2023-2024	Recommended Budget 2023-2024	Recommended Change from Adopted
Salaries and Employee Benefits	\$22,582,939	\$25,992,655	\$24,993,650	\$28,055,691	\$28,035,626	\$2,042,971
Services and Supplies	\$3,112,492	\$3,057,792	\$3,232,650	\$4,078,561	\$2,784,561	\$(273,231)
Other Charges	\$6,597,657	\$4,375,862	\$4,511,528	\$3,549,099	\$3,549,099	\$(826,763)
Capital Assets	—	\$30,000	\$30,979	\$30,000	\$30,000	—
Subtotal	\$32,293,089	\$33,456,309	\$32,768,807	\$35,713,351	\$34,399,286	\$942,977

Source of Funds

Revenues	Prior Year 2021-2022	Adopted Budget 2022-2023	CY Estimate 2022-2023	Requested Budget 2023-2024	Recommended Budget 2023-2024	Recommended Change from Adopted
Fines, Forfeitures, and Penalties	\$495,318	\$645,657	\$885,180	\$499,835	\$499,835	\$(145,822)
Revenue from Use of Money & Property	\$112	\$100	\$122	\$108	\$108	\$8
Intergovernmental Revenues	\$10,842,371	\$11,577,153	\$11,423,992	\$11,833,149	\$11,833,149	\$255,996
Charges for Services	\$55,796	\$55,260	\$26,803	\$38,484	\$38,484	\$(16,776)
Miscellaneous Revenues	\$101,200	\$142,400	\$77,760	\$55,548	\$55,548	\$(86,852)
Other Financing Sources	\$1,433,280	\$1,680,237	\$2,065,249	\$2,097,633	\$2,097,633	\$417,396
Subtotal	\$12,928,077	\$14,100,807	\$14,479,106	\$14,524,757	\$14,524,757	\$423,950
General Fund Contributions	\$19,365,012	\$19,355,502	\$18,289,701	\$20,888,594	\$19,574,529	\$219,027
Restricted Fund Balance	—	—	—	\$300,000	\$300,000	\$300,000
Total Source of Funds	\$32,293,089	\$33,456,309	\$32,768,807	\$35,713,351	\$34,399,286	\$942,977

Unit Description

County discretionary revenues fund approximately 55% of core functions, including prosecution of crimes such as murder, sexual assault, gang crimes, robbery, burglary, felony assault, felony theft, juvenile crimes and all misdemeanor crimes. The other 45% of revenues come from grants and non-GFC sources designated for civil and environmental cases, various types of specialty fraud prosecutions, and crimes committed in the two prisons. The Office reviews over 15,000 cases for filing per year.

The prosecutorial functions of the District Attorney also include, but are not limited to, acting as legal advisor to the Grand Jury, both civil and criminal, and assisting them in their investigations when

requested; working with the United States Attorney to co-prosecute cases in the federal courts; investigating and prosecuting violations of the open meeting laws (Brown Act); reviewing and responding to writs and appeals and extraditions; investigating and prosecuting white collar crimes; conducting commitment and sanity proceedings; investigating public corruption matters involving government officials; undertaking "conflict of interest" criminal investigations for law enforcement agencies, and responding to various County departments as well as municipal departments throughout the County to handle potential criminal violations within their departments and agencies. The District Attorney also attends and advocates at lifer hearings (inmates sentenced to life in prison who are eligible for parole within the discretion of the Board of Parole Hearings) throughout the State multiple times per month.

Recommended FY 2023-24 Positions

Classification Code	Classification Label	FTE
10B04	DISTRICT ATTORNEY	1.00
12A03	CHIEF ASSISTANT DISTRICT ATTORNEY	1.00
12A04	ASSISTANT DISTRICT ATTORNEY	3.00
14C30	MANAGEMENT ANALYST II	1.00
14C70	ADMINISTRATIVE SERVICES ASSISTANT	1.00
14C75	ADMINISTRATIVE ASSISTANT TO DISTRICT ATTORNEY	1.00
14C87	VICTIM/WITNESS ASSISTANCE PROGRAM MANAGER	1.00
14K60	CHIEF DISTRICT ATTORNEY INVESTIGATOR	1.00
20B10	ACCOUNTANT I	1.00
20B11	ACCOUNTANT II	1.00
20B93	FINANCE MANAGER II	1.00
34A20	DISTRICT ATTORNEY INVESTIGATOR I	5.00
34A22	DISTRICT ATTORNEY INVESTIGATOR III	15.00

Recommended FY 2023-24 Positions

Classification Code	Classification Label	FTE
34A80	DISTRICT ATTORNEY INVESTIGATIVE CAPTAIN	1.00
34G10	INVESTIGATIVE AIDE	6.00
39C01	LEGAL ASSISTANT	3.00
39D31	DEPUTY DISTRICT ATTORNEY IV	48.00
43G05	DIGITAL FORENSIC INVESTIGATOR	1.00
43J05	DEPARTMENTAL INFORMATION SYSTEMS COORDINATOR	1.00
60K02	VICTIM ASSISTANCE ADVOCATE	9.00
60K03	VICTIM/WITNESS ASSISTANCE PROGRAM COORDINATOR	1.00
80B11	LEGAL TYPIST	7.00
80B22	LEGAL SECRETARY II	21.00
80B24	SUPERVISING LEGAL SECRETARY	3.00
80B26	LEGAL SECRETARY III	3.00
Total		137.00

Criminal

(Budget Unit 8063—Fund 022—Appropriation Unit DIS002)

Use of Funds

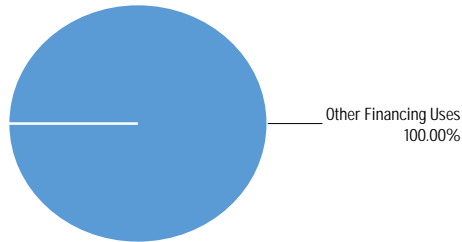

Source of Funds

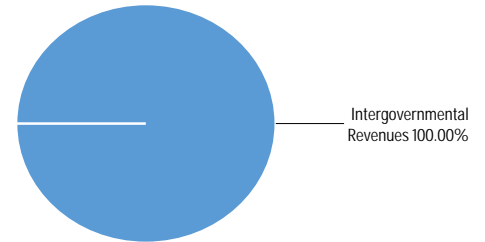

Use of Funds

Expenditures	Prior Year 2021-2022	Adopted Budget 2022-2023	CY Estimate 2022-2023	Requested Budget 2023-2024	Recommended Budget 2023-2024	Recommended Change from Adopted
Other Financing Uses	\$583,955	\$831,413	\$831,413	\$1,055,000	\$1,055,000	\$223,587
Subtotal	\$583,955	\$831,413	\$831,413	\$1,055,000	\$1,055,000	\$223,587

Source of Funds

Revenues	Prior Year 2021-2022	Adopted Budget 2022-2023	CY Estimate 2022-2023	Requested Budget 2023-2024	Recommended Budget 2023-2024	Recommended Change from Adopted
Intergovernmental Revenues	\$583,955	\$831,413	\$831,413	\$1,055,000	\$1,055,000	\$223,587
Subtotal	\$583,955	\$831,413	\$831,413	\$1,055,000	\$1,055,000	\$223,587
Fund Balance	—	—	—	—	—	—
Total Source of Funds	\$583,955	\$831,413	\$831,413	\$1,055,000	\$1,055,000	\$223,587

Unit Description

The FY 2011-12 State budget enacted a shift or "realignment" of State program responsibilities and revenues to local governments. To support the various realigned criminal justice, mental health, and social services programs, the Legislature passed Assembly Bill 118 (Chapter 40, Statutes of 2011). AB 118 created the new Local

Revenue Fund 2011, in which a portion of State sales tax and vehicle license fee revenues are deposited, and provided an accounting structure. For transparency in reporting, the County established Fund 022 to account for all public safety realignment revenues related to the Local Revenue Fund. Operating transfers occur between the General Fund and Fund 022 for realigned programs' payments.

King City

(Budget Unit 8573—Fund 001—Appropriation Unit DIS001)

Use of Funds

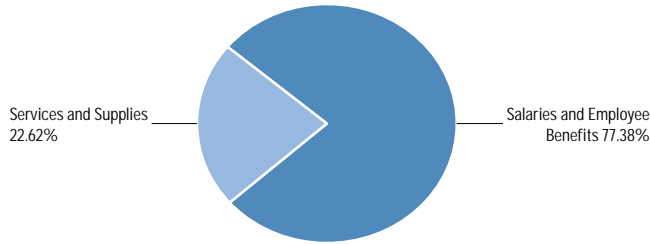

Source of Funds

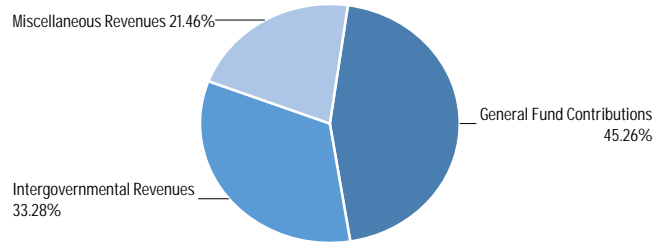

Use of Funds

Expenditures	Prior Year 2021-2022	Adopted Budget 2022-2023	CY Estimate 2022-2023	Requested Budget 2023-2024	Recommended Budget 2023-2024	Recommended Change from Adopted
Salaries and Employee Benefits	—	\$224,203	\$119,416	\$360,588	\$360,588	\$136,385
Services and Supplies	—	\$142,989	\$184,769	\$105,437	\$105,437	\$(37,552)
Capital Assets	—	—	\$1,207	—	—	—
Subtotal	—	\$367,192	\$305,392	\$466,025	\$466,025	\$98,833

Source of Funds

Revenues	Prior Year 2021-2022	Adopted Budget 2022-2023	CY Estimate 2022-2023	Requested Budget 2023-2024	Recommended Budget 2023-2024	Recommended Change from Adopted
Intergovernmental Revenues	—	\$161,683	\$15,000	\$155,097	\$155,097	\$(6,586)
Miscellaneous Revenues	—	—	\$100,000	\$100,000	\$100,000	\$100,000
Subtotal	—	\$161,683	\$115,000	\$255,097	\$255,097	\$93,414
General Fund Contributions	—	\$205,509	\$190,392	\$210,928	\$210,928	\$5,419
Total Source of Funds	—	\$367,192	\$305,392	\$466,025	\$466,025	\$98,833

Unit Description

The Family Justice Center will be located in King City to provide effective, efficient, meaningful and compassionate services to victims of domestic violence, sexual assault, human trafficking, child abuse, and their children. No one agency or organization can possibly address all the needs of survivors. Family Justice Centers and other co-located, multidisciplinary models provide the structure and the foundation to offer flexible, holistic services that can meet the needs of victims and survivors where they are.

The King City office serves victims of crime by providing a full time Spanish speaking victims advocate and legal secretary and working collaboratively with other non-profit service providers who are also Spanish speaking. The office provides essential services for residents

in South County. Victims and their families can access services, including short and long term crisis intervention, without traveling to Salinas or receiving services over the phone. Having a center in South County helps establish trust so that victims feel safe and comfortable in seeking services.

Recommended FY 2023-24 Positions

Classification Code	Classification Label	FTE
60K02	VICTIM ASSISTANCE ADVOCATE	1.00
60K03	VICTIM/WITNESS ASSISTANCE PROGRAM COORDINATOR	1.00
80B22	LEGAL SECRETARY II	1.00
	Total	3.00

Child Support Services

Departmental Overview:

Monterey County Department of Child Support Services (DCSS) is funded with 66% federal and 34% State funds. DCSS puts children first by helping parents provide for the economic and social well-being, health, and stability of their children. All parents, regardless of income or immigration status, are eligible for services.

Programs and Functions:

The primary purpose of DCSS is enforcement and collection of child support for families. A wide variety of activities are undertaken to achieve these objectives: locating parents and their assets; establishing parentage, including genetic testing of parents and children; obtaining court-ordered child support and health insurance coverage; modifying orders; and enforcement of current and past due support obligations.

Department's Contributions to Monterey County's Strategic Initiatives:

ADMINISTRATION

DCSS is committed to cost-effectiveness, continuous improvement, and setting standards for greater accountability. Customer survey results help to provide excellent customer service.

HEALTH AND HUMAN SERVICES

Child support payments ensure children receive the financial support they need, helping to reduce child poverty and improving outcomes for children. Child support is one of the largest sources of income for families in poverty; having that additional source of income on a regular basis helps enhance the quality of life and wellness of those families.

PUBLIC SAFETY

Studies show parents who pay child support are more likely to increase their involvement in their children's lives. As a result, children who have both parents involved are less likely to engage in substance abuse, be incarcerated, have a teen pregnancy, and achieve better results in school.

SUPPORTING

Monterey County's
children

Child Support Services

Operating Budget: \$12,163,694
Positions (FTEs): 82.00

Darrell McGowan
Director

Child Support Services

Staffing Trends

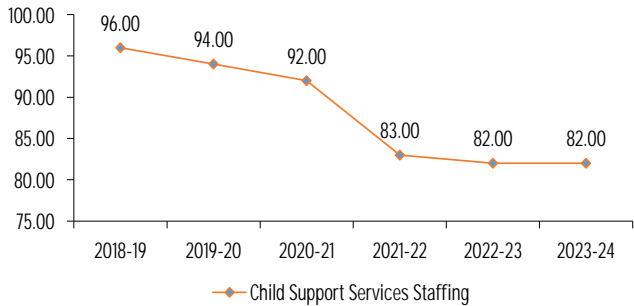

Expenditure/Revenue History (in millions)

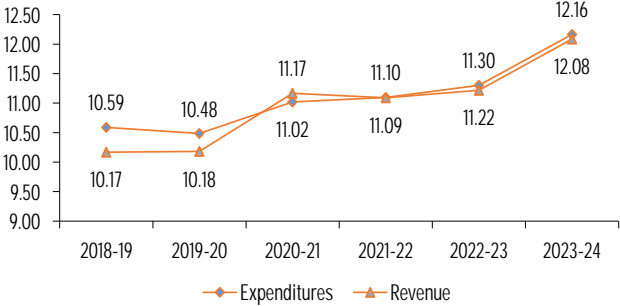

The performance measures are directly aligned with the mission of the child support program and meeting these goals each year results in increased services to customers, greater dollars collected, and optimization of federal incentive dollars.

Key Performance Measures	2020-21 Actual	2021-22 Actual	2022-23 Mid-Year
Outreach events provided to the community. Target = 90.	46	75	31
Customer Survey Satisfaction Rate - Meeting Very Good or above. Target = 95%.	94%	96%	90%
Collections distributed (in millions). Target = \$43.9	\$46.90	\$44.70	\$22.10
Cost Effectiveness (collections compared to expenditures). Target = \$3.68	\$4.27	\$4.33	\$4.44

Use of Funds

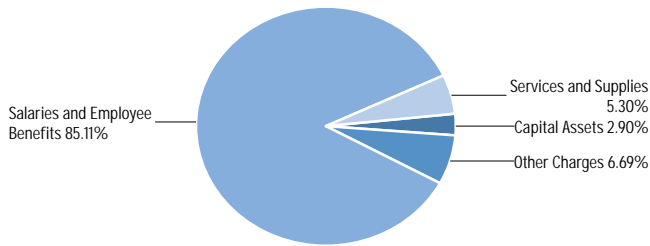

Source of Funds

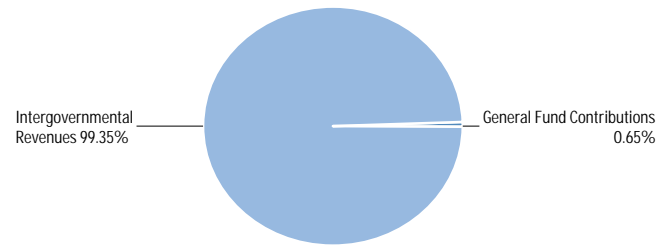

Use of Funds

Expenditures	Prior Year 2021-2022	Adopted Budget 2022-2023	CY Estimate 2022-2023	Requested Budget 2023-2024	Recommended Budget 2023-2024	Recommended Change from Adopted
Salaries and Employee Benefits	\$9,006,652	\$10,014,723	\$9,652,569	\$10,352,018	\$10,352,018	\$337,295
Services and Supplies	\$543,802	\$932,955	\$598,201	\$644,954	\$644,954	\$(288,001)
Other Charges	\$1,193,298	\$699,098	\$699,098	\$813,909	\$813,909	\$114,811
Capital Assets	\$351,692	—	\$351,716	\$352,813	\$352,813	\$352,813
Subtotal	\$11,095,444	\$11,646,776	\$11,301,584	\$12,163,694	\$12,163,694	\$516,918

Source of Funds

Revenues	Prior Year 2021-2022	Adopted Budget 2022-2023	CY Estimate 2022-2023	Requested Budget 2023-2024	Recommended Budget 2023-2024	Recommended Change from Adopted
Revenue from Use of Money & Property	\$4,403	—	—	—	—	—
Intergovernmental Revenues	\$11,087,575	\$11,562,560	\$11,219,395	\$12,084,859	\$12,084,859	\$522,299
Subtotal	\$11,091,978	\$11,562,560	\$11,219,395	\$12,084,859	\$12,084,859	\$522,299
General Fund Contributions	\$3,466	\$84,216	\$82,189	\$78,835	\$78,835	\$(5,381)
Total Source of Funds	\$11,095,444	\$11,646,776	\$11,301,584	\$12,163,694	\$12,163,694	\$516,918

Summary of Recommendation

The Recommended Budget for the Department of Child Support Services (DCSS) is \$12,163,694 which is funded with State and federal funds based on reimbursement of claimed expenditures. Appropriations increase \$516,918 from the FY 2022-23 Adopted Budget, mainly due to increase in employee salaries and benefits, Public Employee Retirement (PERS), and Countywide Cost Allocation Plan (COWCAP) charges.

The State Fiscal Year (SFY) 2023-24 Proposed Governor's Budget released on January 10, 2023, reflects \$35.8 million additional funding for the Local Child Support Administration for SFY 2023-24. With this additional funding, the Department anticipates all its operational costs will be funded by state and federal funds. The general fund contribution (GFC) of \$78,835 covers non recoverable and ERP costs that are not reimbursable by the State.

As required by legislation effective January 1, 2000, this budget has been submitted to the State for approval.

Budget Impacts

No budget impacts.

Prior Year Accomplishments

With a caseload of over 13,070 children, DCSS distributed over \$44.7 million in child support payments during the federal fiscal year 2022. Delivering consistent and reliable child support payments helps reduce poverty and promotes family self-sufficiency in vulnerable households.

The Department continues to have high collection totals while reviewing and streamlining its processes, placing the Department in highest State rankings for the federally mandated collection-to-cost performance measure, collecting \$4.33 for every dollar spent.

The Department continues to set standards for greater accountability and creates an annual business plan, which results in higher performance attainment. Performance measurements are implemented for every employee, and these measurements are utilized in monthly and quarterly coaching and the annual evaluation process.

To enhance customer service, the Department implemented a feedback program through surveys, social media, and emails. The results from July 2022 - March 2023 show a 95% satisfaction rate. Customers also have the opportunity to take advantage of the Department's self-check-in PC's available in the lobby which reduces wait times to two minutes or less to be helped by their case manager.

Provided information about the program, such as parentage adjudication and the establishment and enforcement of child support, through outreach programs at schools and community events. Public service announcements and direct mailings to those in need of services continue.

Use best practices and innovation so families and children receive the optimal amount of child support and health insurance coverage.

Use racial equity tools when applicable to analyze and improve policies and practices.

The Department has embraced the shared services concept and continues to have an agreement with the Ventura County Department of Child Support Services, at no cost, to answer non-emergency telephone calls.

Continue to have a proactive outreach program with emphasis on collaboration with other County departments and community organizations. Continue to increase outreach in remote communities.

Leverage technology to increase effectiveness and efficiency.

Continued an ongoing internal safety committee to help decrease workers' compensation costs. The committee's purpose is to help educate staff regarding health and safety issues and identify potential safety issues and be proactive in addressing them.

Continue to review cost saving opportunities and sharing of services with child support agencies in other counties. Develop and retain employees by providing ongoing professional and personal development courses through the County's Learning Management System, the Employee Wellness Program, and other internal and external courses.

Budget Year Goals

Increase the frequency and reliability of child support payments for families, so they can depend on this important source of income.

Pending Issues

There are no pending issues.

Increase in all federal and State performance measures with emphasis on collections distributed to families and cost efficiency for delivery of service.

Policy Considerations

There are no policy considerations.

Continue to provide quality service to customers.

Appropriation Expenditure Detail

	Prior Year 2021-2022	Adopted Budget 2022-2023	CY Estimate 2022-2023	Requested Budget 2023-2024	Recommended Budget 2023-2024	Recommended Change from Adopted	Fund Code	Budget Unit Code
Child Support Services (CHI001)	11,095,444	11,646,776	11,301,584	12,163,694	12,163,694	516,918	001	8018
Subtotal	\$11,095,444	\$11,646,776	\$11,301,584	\$12,163,694	\$12,163,694	\$516,918		

Budget Units

	Prior Year 2021-2022	Adopted Budget 2022-2023	CY Estimate 2022-2023	Requested Budget 2023-2024	Recommended Budget 2023-2024	Recommended Change from Adopted
Child Support Services	\$11,095,444	\$11,646,776	\$11,301,584	\$12,163,694	\$12,163,694	\$516,918
Subtotal	\$11,095,444	\$11,646,776	\$11,301,584	\$12,163,694	\$12,163,694	\$516,918

Adopted FY 2022-23 to Recommended FY 2023-24 Positions

Classification Code	Classification Label	Adopted Budget 2021-2022	Adopted Budget 2022-2023	Recommended Budget 2023-2024	Change
11A26	DIRECTOR OF CHILD SUPPORT SERVICES	1.00	1.00	1.00	0.00
14C30	MANAGEMENT ANALYST II	1.00	1.00	1.00	0.00
14C31	MANAGEMENT ANALYST III	1.00	0.00	0.00	0.00
14K62	DEPUTY DIRECTOR CHILD SUPPORT SERVICES	1.00	1.00	1.00	0.00
20B11	ACCOUNTANT II	1.00	1.00	1.00	0.00
20B95	FINANCE MANAGER I	1.00	1.00	1.00	0.00
25C18	CHILD SUPPORT ASSISTANT II	5.00	5.00	5.00	0.00
25C23	CHILD SUPPORT OFFICER II	40.00	40.00	40.00	0.00
25C24	CHILD SUPPORT OFFICER III	8.00	8.00	8.00	0.00
25C81	SUPERVISING CHILD SUPPORT OFFICER	5.00	5.00	5.00	0.00
25C82	CHILD SUPPORT PERFORMANCE SPECIALIST	1.00	1.00	1.00	0.00
34G21	CIVIL PROCESS SERVER	1.00	1.00	1.00	0.00
34G22	SENIOR CIVIL PROCESS SERVER	1.00	1.00	1.00	0.00

Adopted FY 2022-23 to Recommended FY 2023-24 Positions

Classification Code	Classification Label	Adopted Budget 2021-2022	Adopted Budget 2022-2023	Recommended Budget 2023-2024	Change
39A47	CHIEF CHILD SUPPORT ATTORNEY	1.00	1.00	1.00	0.00
39D36	CHILD SUPPORT ATTORNEY IV	3.00	3.00	3.00	0.00
70F21	COURIER	1.00	1.00	1.00	0.00
80B22	LEGAL SECRETARY II	1.00	1.00	1.00	0.00
80D23	LEGAL PROCESS CLERK	1.00	1.00	1.00	0.00
80E21	OFFICE ASSISTANT II	1.00	1.00	1.00	0.00
80E80	PRINCIPAL OFFICE ASSISTANT	1.00	1.00	1.00	0.00
80J20	ACCOUNTING CLERICAL SUPERVISOR	1.00	1.00	1.00	0.00
80J21	ACCOUNT CLERK	3.00	3.00	3.00	0.00
80J22	SENIOR ACCOUNT CLERK	1.00	1.00	1.00	0.00
80J30	ACCOUNTING TECHNICIAN	2.00	2.00	2.00	0.00
Total		83.00	82.00	82.00	0.00



This page intentionally left blank.

Public Defender

Department Overview:

Through the Office of the Public Defender and Office of the Alternate Defender, the department provides representation to indigent adult and juvenile individuals who cannot afford an attorney in criminal and limited civil matters. A strong and fully funded Public Defender is essential to protecting the rights of all and ensures balance throughout the criminal justice system. Public Defenders utilize the therapeutic courts to reduce recidivism by channeling non-violent offenders through Drug Court, DUI Court, Veterans' Court, and mental health diversion programs.

Programs and Functions:

CRIMINAL UNIT: The core function of the Public Defender is to defend indigent individuals accused of committing crimes. Misdemeanor offenses include, but are not limited to, shoplifting, driving under the influence, drug possession, and assault and battery. Felony matters include, but are not limited to, murder, sex crimes, gang-related offenses, Three Strikes, embezzlement, fraud, domestic violence and first-degree burglary. The juvenile division represents youth in delinquency, felony and misdemeanor matters and pairs youths' educational, mental health, and social needs with County and State resources. The department handles approximately 12,000 criminal cases per year.

CIVIL UNIT: Mental Health Division cases include, but are not limited to, criminal matters, probate, and conservatorships to ensure Public Defender's clients' health and finances are protected. These individuals are some of our most vulnerable clients. The Post Sentence Relief Division assists individuals with record expungement services, obtaining certificates of rehabilitation, and applying for pardons to enable them to successfully reenter the community as productive members of society. Our immigration attorney provides critical information for immigration neutral plea negotiations, dispositions, and sentencing for Public Defender and Alternate Defender non-citizen clients.

Department's Contribution to Monterey County's Strategic Initiatives:

HEALTH AND HUMAN SERVICES

Protecting the mental and physical health of youth and adults unable to care for themselves by asserting their right to effective assistance of counsel in criminal and limited civil court divisions and utilizing a holistic approach by providing potential referrals to healthcare, education, and behavioral health services.

PUBLIC SAFETY

Protecting and defending the right to live in a society free of and safe from unlawful State interference, by vigorously defending individual rights and providing post relief services.

ECONOMIC DEVELOPMENT

Collaborating with Monterey County Public Safety partners to keep clients in nonviolent cases out of custody and in the workforce to avoid unnecessary disruptions to employment and business activity.



Public Defender

Operating Budget: \$18,962,984
Positions (FTEs): 60.00

Susan E. Chapman
Public Defender

Alternate Defender's Office

Public Defender

Staffing Trends

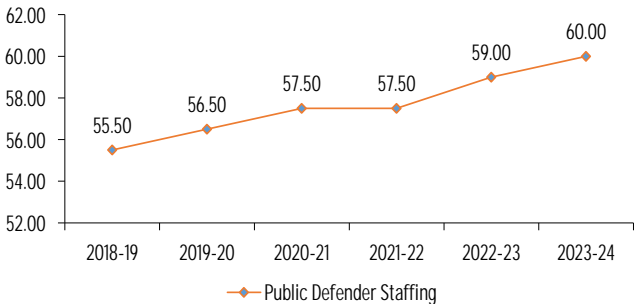

Expenditure/Revenue History (in millions)

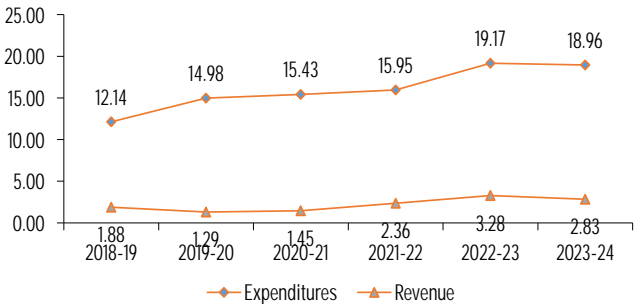

The Public Defender provides legal assistance to individuals charged with a crime who are financially unable to retain private counsel. This also includes mental health, juvenile court, state prison matters, and post sentence relief.

Key Performance Measures	2020-21 Actual	2021-22 Actual	2022-23 Mid-Year
Number of new felony matters handled. Target = 1,578	2,445	2,371	1,195
Number of new misdemeanor matters handled. Target = 2,400	7,962	7,786	3,899
Number of new juvenile matters handled. Target = 420	508	657	364
Number of new mental health matters handled. Target = 100	108	124	79
Number of new prison matters handled. Target = 150	56	318	127
Number of new post-sentence relief matters handled. Target = 75	461	115	138

Use of Funds

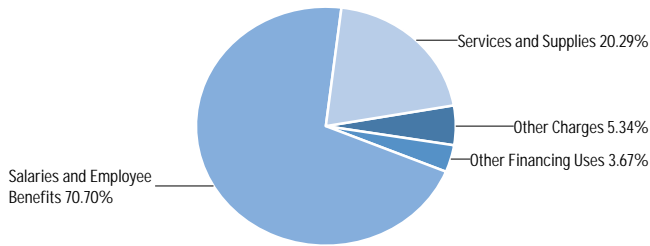

Source of Funds

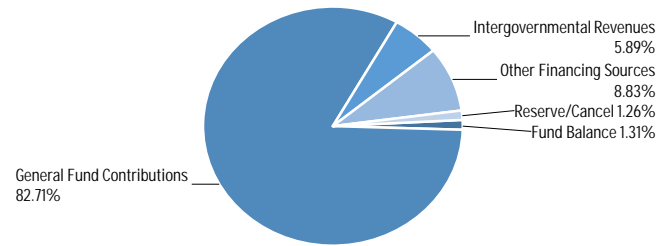

Use of Funds

Expenditures	Prior Year 2021-2022	Adopted Budget 2022-2023	CY Estimate 2022-2023	Requested Budget 2023-2024	Recommended Budget 2023-2024	Recommended Change from Adopted
Salaries and Employee Benefits	\$11,047,711	\$12,593,933	\$12,658,693	\$13,405,889	\$13,405,889	\$811,956
Services and Supplies	\$3,472,524	\$4,244,535	\$4,301,856	\$3,848,404	\$3,848,404	\$(396,131)
Other Charges	\$1,431,994	\$1,611,169	\$1,512,741	\$1,012,202	\$1,012,202	\$(598,967)
Other Financing Uses	—	\$696,489	\$696,489	\$696,489	\$696,489	—
Subtotal	\$15,952,229	\$19,146,126	\$19,169,779	\$18,962,984	\$18,962,984	\$(183,142)

Source of Funds

Revenues	Prior Year 2021-2022	Adopted Budget 2022-2023	CY Estimate 2022-2023	Requested Budget 2023-2024	Recommended Budget 2023-2024	Recommended Change from Adopted
Intergovernmental Revenues	\$1,840,115	\$931,677	\$1,774,205	\$1,131,718	\$1,131,718	\$200,041
Charges for Services	\$318	\$500	\$500	\$500	\$500	—
Miscellaneous Revenues	\$4,722	—	—	—	—	—
Other Financing Sources	\$519,059	\$1,665,804	\$1,503,281	\$1,695,808	\$1,695,808	\$30,004
Subtotal	\$2,364,215	\$2,597,981	\$3,277,986	\$2,828,026	\$2,828,026	\$230,045
Fund Balance	\$(386,756)	\$389,312	\$344,561	\$251,721	\$251,721	\$(137,591)
General Fund Contributions	\$13,974,771	\$16,158,833	\$15,547,232	\$15,641,492	\$15,641,492	\$(517,341)
General Fund - Restricted Fund Balance	—	—	—	\$241,745	\$241,745	\$241,745
Total Source of Funds	\$15,952,229	\$19,146,126	\$19,169,779	\$18,962,984	\$18,962,984	\$(183,142)

Summary of Recommendation

The Recommended Budget for the department is \$18,962,984, a net decrease of \$183,142 from the current year Adopted Budget. The Recommended Budget is financed by \$2,828,026 in anticipated program revenue, \$15,641,492 in General Fund Contributions (GFC), \$241,745 in departmental restricted revenue and \$251,721 departmental fund balance. The departmental budget reflects a reduction associated with the expiration of a Board of State and Community Corrections (BSCC) grant. The Public Defender's Office experienced higher costs due to wage adjustments, negotiated salaries, pension contributions, and \$696,489 in operating transfers from the Local Revenue Fund (AB109 Public Safety Realignment).

Due to the fiscal pressures mentioned above, the Recommended Budget includes \$292,270 in augmentations to restore one filled Deputy Public Defender IV attorney position. This position ensures the continuity of services to indigent clients in the trial courts. The Recommended Budget includes a total of 59.0 FTE's, including Chief Deputy Public Defender position that was reclassified to an Assistant Public Defender during the course of the fiscal year.

Budget Impacts

The FY 2023-24 Recommended Budget allows the department to maintain current service levels to County indigent clients. However, the increased costs of wage adjustments, employee step advances, retirement, and healthcare restrict the department's flexibility to assign resources to rapidly changing service needs.

Further, the passage of recent legislation will require additional extensive research, case history reviews, and potential resentencing hearings in serious felony cases as well as additional resources for mental health diversion matters. These are time intensive cases that involve written motions, hearings, and writ petitions, creating additional demands on the department's staff and resources.

The department continues to face key challenges with the number of special circumstance cases and cases involving charges carrying life sentences. Funding for these potential service costs is not included in the Recommended Budget.

Prior Year Accomplishments

The Budget Act of 2020 (Senate Bill 74) established the Indigent Defense Grant Program and allocated funding administered by the BSCC. The Monterey County Public Defender was one of a select group of counties awarded monies under this program. The grant funding provided through 2023 helped the Public Defender implement the Attorney Case Management Enhancement (ACME) project to support attorney trainings and technology upgrades.

The Budget Act of 2021 (Senate Bill 129) established the Public Defense Pilot Program and allocated funding administered by the BSCC. The department was awarded monies under this program. The grant funding is provided through 2024 and will be utilized by the Public Defender to provide indigent defense services for specific penal code section matters.

Budget Year Goals

Continue to work with Justice Partners to develop the homeless court to address unique challenges that homeless clients face in accessing the legal system.

The department upgraded its case management system and is positioned to identify opportunities for increasing efficiencies through technology to improve client representation and outcomes. This CMS sends out automatic text message reminders for court appearances to reduce failures to appear and subsequent bench warrants.

Expand Public Defender service to address the proposed Care Court and other mental health therapeutic court services along with new legislative mandates.

Invest in staff development to meet the evolving 21st century workforce. The department will continue to facilitate in-house

training, specialized training for attorneys to meet mandated legal education requirements and partner with outside organizations for additional training to provide opportunities for staff to engage in professional development throughout the fiscal year.

Pending Issues

The department continues to incur additional costs for mandated services without corresponding long term funding. SB 1437 redefined murder and allows inmates serving sentences for felony murder to be resentenced if their crimes meet certain conditions. Under SB 1437, the public defender represents these inmates in the Superior Courts. AB 1810 created a mental health diversion program that suspends criminal proceedings while the defendant participates in up to a two-year treatment program. Upon successful completion, criminal charges are dismissed. The program continues to evolve and expand within the court system. This program requires additional social work and behavioral health resources within the department. Penal Code 1170.95, 1170(d)(1), 1433.7 and 3051 also have created new duties and responsibilities for the Public Defender which has substantially increased attorney workloads.

Digital Divide: As the Public Safety partners transitioned from paper to digital information storage, emergency measures have been used to provide a sufficient digital storage program for massive amounts of digital data received from law enforcement. Requirements to keep data for the lifetime of each client accentuates the problem. The Information Technology Department (ITD) continues to work with safety partners to develop a better plan for storage and sharing of data to streamline the process and make it more cost effective.

Policy Considerations

There are no policy considerations.

Appropriation Expenditure Detail

	Prior Year 2021-2022	Adopted Budget 2022-2023	CY Estimate 2022-2023	Requested Budget 2023-2024	Recommended Budget 2023-2024	Recommended Change from Adopted	Fund Code	Budget Unit Code
Alternate Defenders Office (PUB001)	2,585,476	3,043,662	3,033,538	3,049,807	3,049,807	6,145	001	8168
Public Defender (PUB001)	13,366,753	15,405,975	15,439,752	15,216,688	15,216,688	(189,287)	001	8169
Public Defender (PUB002)	0	696,489	696,489	696,489	696,489	0	022	8169
Subtotal	\$15,952,229	\$19,146,126	\$19,169,779	\$18,962,984	\$18,962,984	\$(183,142)		

Budget Units

	Prior Year 2021-2022	Adopted Budget 2022-2023	CY Estimate 2022-2023	Requested Budget 2023-2024	Recommended Budget 2023-2024	Recommended Change from Adopted
Alternate Defenders Office	\$2,585,476	\$3,043,662	\$3,033,538	\$3,049,807	\$3,049,807	\$6,145
Public Defender	\$13,366,753	\$16,102,464	\$16,136,241	\$15,913,177	\$15,913,177	\$(189,287)
Subtotal	\$15,952,229	\$19,146,126	\$19,169,779	\$18,962,984	\$18,962,984	\$(183,142)

Adopted FY 2022-23 to Recommended FY 2023-24 Positions

Classification Code	Classification Label	Adopted Budget 2021-2022	Adopted Budget 2022-2023	Recommended Budget 2023-2024	Change
11A18	PUBLIC DEFENDER	1.00	1.00	1.00	0.00
12A06	CHIEF ASSISTANT PUBLIC DEFENDER	0.00	1.00	1.00	0.00
12C11	ASSISTANT PUBLIC DEFENDER	1.00	1.00	2.00	1.00
14C30	MANAGEMENT ANALYST II	1.00	2.00	2.00	0.00
14G02	MANAGEMENT ANALYST I	1.00	0.00	0.00	0.00
20B10	ACCOUNTANT I	1.00	1.00	1.00	0.00
20B95	FINANCE MANAGER I	1.00	1.00	1.00	0.00
34D40	PUBLIC DEFENDER INVESTIGATOR III	6.00	6.00	6.00	0.00
34D78	CHIEF PUBLIC DEFENDER INVESTIGATOR	1.00	1.00	1.00	0.00
39P31	DEPUTY PUBLIC DEFENDER IV	26.00	26.00	26.00	0.00
39P35	CHIEF DEPUTY PUBLIC DEFENDER	4.00	4.00	4.00	0.00
60B21	PSYCHIATRIC SOCIAL WORKER II	1.00	1.00	1.00	0.00
80A99	ADMINISTRATIVE SECRETARY-CONFIDENTIAL	1.00	1.00	1.00	0.00
80B22	LEGAL SECRETARY	9.00	9.00	9.00	0.00
80B23	SENIOR LEGAL SECRETARY	1.00	1.00	0.00	(1.00)
80B24	SUPERVISING LEGAL SECRETARY	1.00	1.00	1.00	0.00
80B26	LEGAL SECRETARY III	0.00	0.00	1.00	1.00
80E21	OFFICE ASSISTANT II	1.00	1.00	0.00	(1.00)
80E22	OFFICE ASSISTANT III	0.00	0.00	1.00	1.00
80J21	ACCOUNT CLERK	0.50	1.00	1.00	0.00
Total		57.50	59.00	60.00	1.00

Augmentation Request

Request Code	Request Name	Ranking Type Name	Requested Amount	Requested FTE	Recommended Budget	Recommended FTE
2270-8169-001-AUG1	Status Quo Filled DPD IV	Status Quo Filled Position	292,970	1.00	292,970	1.00
Grand Total:			\$292,970	1.00	\$292,970	1.00

Public Defender

Alternate Defender's Office

(Budget Unit 8168—Fund 001—Appropriation Unit PUB001)

Use of Funds

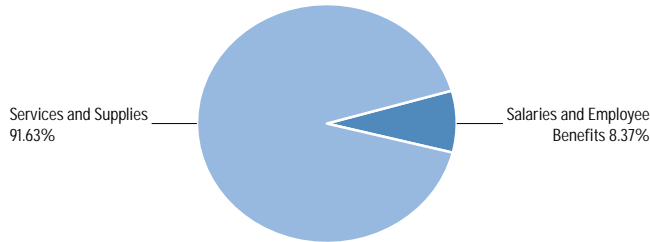

Source of Funds

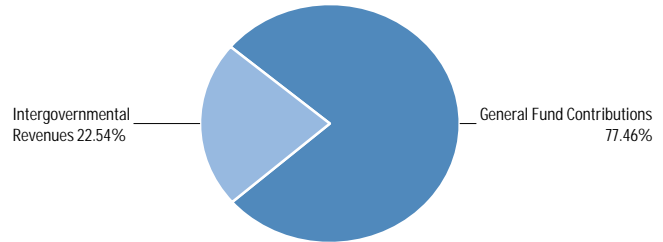

Use of Funds

Expenditures	Prior Year 2021-2022	Adopted Budget 2022-2023	CY Estimate 2022-2023	Requested Budget 2023-2024	Recommended Budget 2023-2024	Recommended Change from Adopted
Salaries and Employee Benefits	\$185,082	\$241,409	\$237,081	\$255,346	\$255,346	\$13,937
Services and Supplies	\$2,400,395	\$2,802,253	\$2,796,457	\$2,794,461	\$2,794,461	\$(7,792)
Subtotal	\$2,585,476	\$3,043,662	\$3,033,538	\$3,049,807	\$3,049,807	\$6,145

Source of Funds

Revenues	Prior Year 2021-2022	Adopted Budget 2022-2023	CY Estimate 2022-2023	Requested Budget 2023-2024	Recommended Budget 2023-2024	Recommended Change from Adopted
Intergovernmental Revenues	\$816,359	\$624,500	\$624,500	\$686,950	\$686,950	\$62,450
Other Financing Sources	—	\$1,500	\$1,500	\$1,500	\$1,500	—
Subtotal	\$816,359	\$626,000	\$626,000	\$688,450	\$688,450	\$62,450
General Fund Contributions	\$1,769,117	\$2,417,662	\$2,407,538	\$2,361,357	\$2,361,357	\$(56,305)
Total Source of Funds	\$2,585,476	\$3,043,662	\$3,033,538	\$3,049,807	\$3,049,807	\$6,145

Unit Description

The Court Assigned Counsel Unit, referred to as the Alternate Defender's Office (ADO), represents clients in criminal cases in which the Public Defender's Office has a conflict of interest or is otherwise unable to accept representation. The ADO meets these mandates through the combination of contract attorneys and panel attorneys. The Chief Alternate Defender maintains operational responsibility and manages the contract attorneys and panel attorneys. Panel attorneys are used in cases when the contract attorneys have a conflict and in cases falling outside the contract, e.g., capital cases. The ADO has a dedicated and diverse team committed to ensuring that the right to effective and competent legal representation in

criminal and juvenile cases is a reality for Monterey County residents. The ADO provides funds for appointed counsel and related defense costs, including but not limited to investigations, expert witnesses, forensic laboratory procedures, interpreters, and transcriptions for indigent clients who are not represented by the Public Defender.

Recommended FY 2023-24 Positions

Classification Code	Classification Label	FTE
14C30	MANAGEMENT ANALYST II	1.00
80J21	ACCOUNT CLERK	1.00
Total		2.00

Public Defender

(Budget Unit 8169—Fund 001—Appropriation Unit PUB001)

Use of Funds

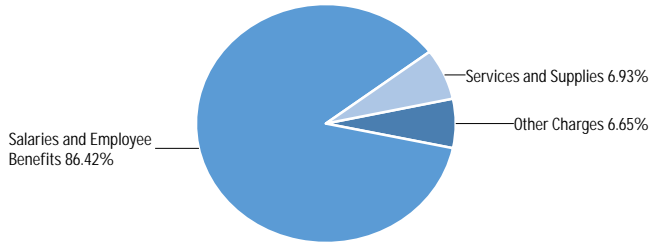

Source of Funds

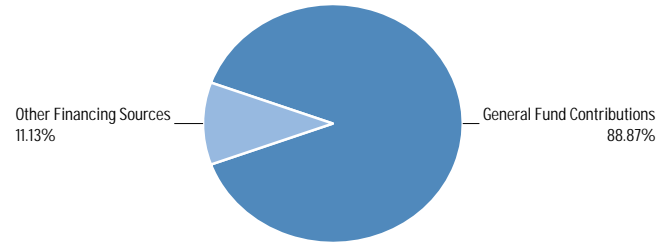

Use of Funds

Expenditures	Prior Year 2021-2022	Adopted Budget 2022-2023	CY Estimate 2022-2023	Requested Budget 2023-2024	Recommended Budget 2023-2024	Recommended Change from Adopted
Salaries and Employee Benefits	\$10,862,629	\$12,352,524	\$12,421,612	\$13,150,543	\$13,150,543	\$798,019
Services and Supplies	\$1,072,130	\$1,442,282	\$1,505,399	\$1,053,943	\$1,053,943	\$(388,339)
Other Charges	\$1,431,994	\$1,611,169	\$1,512,741	\$1,012,202	\$1,012,202	\$(598,967)
Subtotal	\$13,366,753	\$15,405,975	\$15,439,752	\$15,216,688	\$15,216,688	\$(189,287)

Source of Funds

Revenues	Prior Year 2021-2022	Adopted Budget 2022-2023	CY Estimate 2022-2023	Requested Budget 2023-2024	Recommended Budget 2023-2024	Recommended Change from Adopted
Intergovernmental Revenues	\$637,000	—	\$797,777	—	—	—
Charges for Services	\$318	\$500	\$500	\$500	\$500	—
Miscellaneous Revenues	\$4,722	—	—	—	—	—
Other Financing Sources	\$519,059	\$1,664,304	\$1,501,781	\$1,694,308	\$1,694,308	\$30,004
Subtotal	\$1,161,100	\$1,664,804	\$2,300,058	\$1,694,808	\$1,694,808	\$30,004
Restricted Fund Balance	—	—	—	\$241,745	\$241,745	\$241,745
General Fund Contributions	\$12,205,653	\$13,741,171	\$13,139,694	\$13,280,135	\$13,280,135	\$(461,036)
Total Source of Funds	\$13,366,753	\$15,405,975	\$15,439,752	\$15,216,688	\$15,216,688	\$(189,287)

Unit Description

The Public Defender provides legal representation to indigent persons in Monterey Superior Court matters. While most clients are defendants in criminal cases, the Public Defender also provides representation in probate, conservatorship, and limited civil matters, including when mental health clients' liberty may be at risk.

The department also provides representation of youths in matters within the jurisdiction of the juvenile courts of Monterey County. This function includes having an attorney available around the clock to consult arrested juveniles prior to questioning.

The Post Sentence Relief Team paved the way to clear and expunge records, reduce felony convictions to misdemeanors, process certificates of rehabilitation and pursue other legal post-conviction remedies as provided by law. The program has expanded and streamlined its post sentence relief program to give more individuals a

new start, stabilize families, reduce recidivism, and increase public safety by enhancing sustainable housing, education, and employment opportunities.

The department's Specialized Immigration Attorney provides vital consultations to resolve criminal cases for more than 600 non-citizens and indigent clients, limiting potential negative immigration consequences for this important population. A psychiatric social worker is on staff to identify clients' needs by conducting early assessments and developing treatment plans to pave the way for successful reentry into our communities.

Discretionary services are provided to veterans, the homeless, and others who require legal help to obtain gainful employment and rejoin a productive society. The department participates in community outreach events that facilitate County residents' ability to reenter the job market and make positive contributions while decreasing the financial strain on the County and reducing recidivism. These include Hartnell's Career Day, Lotus Day by Gathering for Women, and City

of Marina’s National Night Out. Every even-numbered year, the department participates in the Veterans Stand Down event which refers veterans to various services such as substance abuse treatment, mental health care, employment, housing, and access to a homeless court where they can resolve minor violations. These critical services are the catalyst for veterans to successfully return to mainstream society. These activities support the department’s mission to expand outreach throughout Monterey County.

The functions of the department allow the County to meet its obligations imposed under the Constitutions of the United States and California and other applicable statutes such as California Government Code section 27706.

Recommended FY 2023-24 Positions

Classification Code	Classification Label	FTE
11A18	PUBLIC DEFENDER	1.00
12A06	CHIEF ASSISTANT PUBLIC DEFENDER	1.00
12C11	ASSISTANT PUBLIC DEFENDER	2.00
14C30	MANAGEMENT ANALYST II	1.00
20B10	ACCOUNTANT I	1.00

Recommended FY 2023-24 Positions

Classification Code	Classification Label	FTE
20B95	FINANCE MANAGER I	1.00
34D40	PUBLIC DEFENDER INVESTIGATOR III	6.00
34D78	CHIEF PUBLIC DEFENDER INVESTIGATOR	1.00
39P31	DEPUTY PUBLIC DEFENDER IV	26.00
39P35	CHIEF DEPUTY PUBLIC DEFENDER	4.00
60B21	PSYCHIATRIC SOCIAL WORKER II	1.00
80A99	ADMINISTRATIVE SECRETARY-CONFIDENTIAL	1.00
80B22	LEGAL SECRETARY II	9.00
80B24	SUPERVISING LEGAL SECRETARY	1.00
80B26	LEGAL SECRETARY III	1.00
80E22	OFFICE ASSISTANT III	1.00
Total		58.00

Public Defender

(Budget Unit 8169—Fund 022—Appropriation Unit PUB002)

Use of Funds

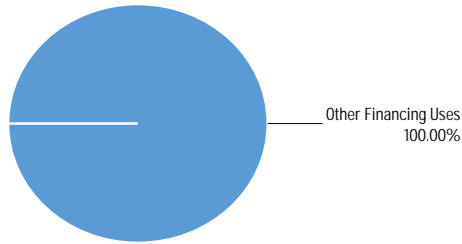

Source of Funds

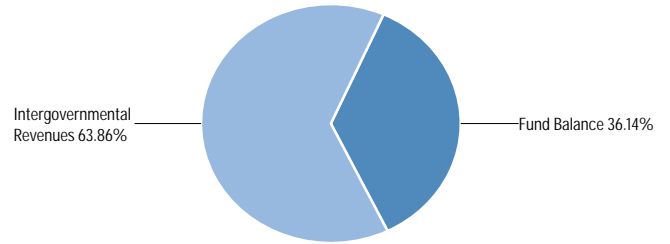

Use of Funds

Expenditures	Prior Year 2021-2022	Adopted Budget 2022-2023	CY Estimate 2022-2023	Requested Budget 2023-2024	Recommended Budget 2023-2024	Recommended Change from Adopted
Other Financing Uses	—	\$696,489	\$696,489	\$696,489	\$696,489	—
Subtotal	—	\$696,489	\$696,489	\$696,489	\$696,489	—

Source of Funds

Revenues	Prior Year 2021-2022	Adopted Budget 2022-2023	CY Estimate 2022-2023	Requested Budget 2023-2024	Recommended Budget 2023-2024	Recommended Change from Adopted
Intergovernmental Revenues	\$386,756	\$307,177	\$351,928	\$444,768	\$444,768	\$137,591
Subtotal	\$386,756	\$307,177	\$351,928	\$444,768	\$444,768	\$137,591
Fund Balance	\$(386,756)	\$389,312	\$344,561	\$251,721	\$251,721	\$(137,591)
Total Source of Funds	—	\$696,489	\$696,489	\$696,489	\$696,489	—

Unit Description

The FY 2011-12 State budget enacted a shift or "realignment" of State program responsibilities and revenues to local governments. To support the various realigned criminal justice, mental health, and social services programs, the Legislature passed Assembly Bill 118 (Chapter 40, Statutes of 2011). AB 118 created the new Local

Revenue Fund 2011, in which a portion of State sales tax and vehicle license fee revenues are deposited, and provided an accounting structure. For transparency in reporting, the County established Fund 022 to account for all public safety realignment revenues related to the Local Revenue Fund. Operating transfers occur between the General Fund and Fund 022 for realigned programs' payments.



This page intentionally left blank.

Sheriff-Coroner

Departmental Overview:

The Sheriff's Office provides public safety services to the residents of Monterey County. Services include 24-hour uniformed patrol, the investigation of crimes, criminal records management and community policing. It is also responsible for the safekeeping and security of persons arrested by any law enforcement agency in Monterey County. In addition, in fulfilling the duties of the Coroner, staff investigates all reportable deaths to determine the cause and manner of those deaths. The Sheriff-Coroner is an elected official per the authority of the California Government Code and Health and Safety Code.

Programs and Functions:

The Sheriff's Office provides law enforcement, investigations, custody services, court security, coroner operations and law enforcement support.

Department's Contribution to Monterey County's Strategic Initiatives:

ECONOMIC DEVELOPMENT

The Office provides essential public safety services and keeping the County safe enhances people's desire to live, work, and recreate in Monterey County.

ADMINISTRATION

The Sheriff's executive management team meets weekly to develop policies to improve services to the public. The team engages other County departments, the judiciary, and the public on a regular basis to assess current service delivery models. As an elected official, the Sheriff meets with the public to discuss public safety policy and obtain community input and feedback on operational issues.

HEALTH AND HUMAN SERVICES

Sheriff's Deputies are first responders and quickly deploy to disasters that jeopardize the health and safety of our community.

INFRASTRUCTURE

The Office provides infrastructure protection through rapid responses and collaborative efforts with other public safety partners at the local, State and federal levels.

PUBLIC SAFETY

The Sheriff's Office promotes safe communities by providing patrol, investigations and crime prevention efforts.



Operating Budget: \$157,734,166
Positions (FTEs): 468.00

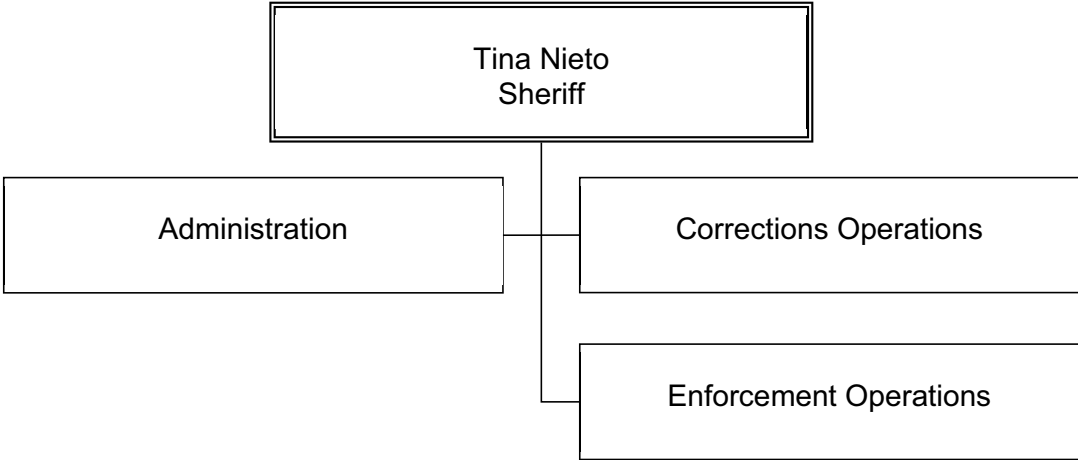

Staffing Trends

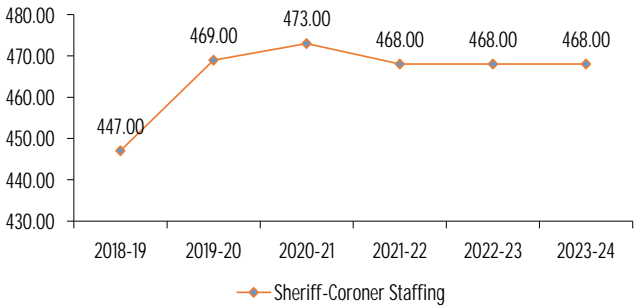

Expenditure/Revenue History (in millions)

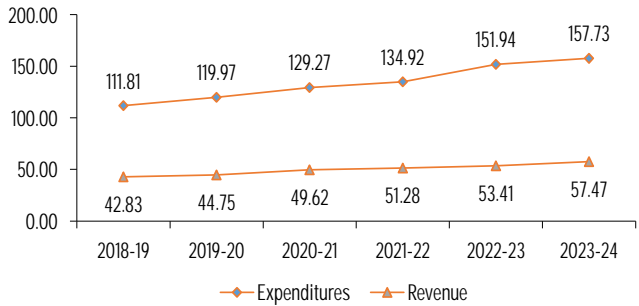

The Sheriff-Coroner Department is divided into three bureaus: Administration Operations, Enforcement Operations (patrol), and Correction Operations (jail).

Key Performance Measures	2020-21 Actual	2021-22 Actual	2022-23 Mid-Year
COB - Number of County jail bookings processed.	9,351	10,105	5,979
COB - Average number of days a released inmate is housed in the jail.	43	34	33
COB - Number of jail program completions.	26,561	19,181	9,508
COB - Number of inmate visits.	10,115	11,847	5,213
EOB - Number of calls for service completed.	59,641	72,454	35,225
EOB - Number of violent crimes reported.	812	753	374
AOB - Number of applicant backgrounds checked.	135	113	36
AOB - Number of employees hired.	47	53	21
AOB - Number of workers' compensation claims department-wide.	108	121	47

Use of Funds

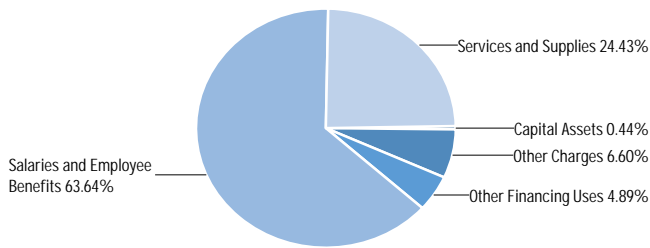

Source of Funds

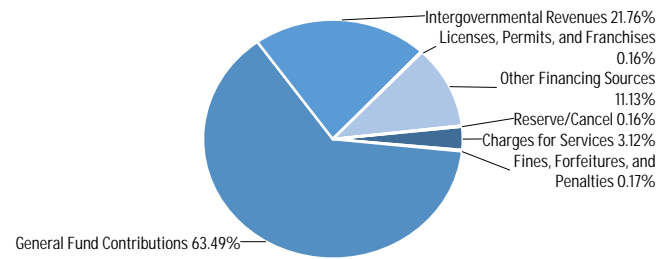

Use of Funds

Expenditures	Prior Year 2021-2022	Adopted Budget 2022-2023	CY Estimate 2022-2023	Requested Budget 2023-2024	Recommended Budget 2023-2024	Recommended Change from Adopted
Salaries and Employee Benefits	\$90,605,644	\$97,163,618	\$100,247,353	\$102,553,541	\$100,378,393	\$3,214,775
Services and Supplies	\$31,062,615	\$32,679,355	\$33,806,431	\$39,868,352	\$38,539,352	\$5,859,997
Other Charges	\$7,167,359	\$10,349,274	\$10,140,627	\$10,416,190	\$10,416,190	\$66,916
Capital Assets	\$247,237	\$612,200	\$963,200	\$1,026,200	\$686,200	\$74,000
Other Financing Uses	\$5,833,674	\$6,718,000	\$6,777,483	\$7,714,031	\$7,714,031	\$996,031
Subtotal	\$134,916,529	\$147,522,447	\$151,935,094	\$161,578,314	\$157,734,166	\$10,211,719

Source of Funds

Revenues	Prior Year 2021-2022	Adopted Budget 2022-2023	CY Estimate 2022-2023	Requested Budget 2023-2024	Recommended Budget 2023-2024	Recommended Change from Adopted
Licenses, Permits, and Franchises	\$210,564	\$240,549	\$220,000	\$254,700	\$254,700	\$14,151
Fines, Forfeitures, and Penalties	\$171,609	\$254,504	\$124,166	\$274,606	\$274,606	\$20,102
Revenue from Use of Money & Property	\$54,250	\$67,000	\$67,000	\$67,000	\$67,000	—
Intergovernmental Revenues	\$32,418,232	\$32,190,519	\$32,157,156	\$34,355,499	\$34,355,499	\$2,164,980
Charges for Services	\$3,989,334	\$4,860,896	\$4,810,663	\$4,928,729	\$4,928,729	\$67,833
Miscellaneous Revenues	\$145,500	\$410,000	\$79,088	\$10,532	\$10,532	\$(399,468)
Other Financing Sources	\$14,289,028	\$15,700,215	\$15,948,143	\$17,581,869	\$17,581,869	\$1,881,654
Subtotal	\$51,278,516	\$53,723,683	\$53,406,216	\$57,472,935	\$57,472,935	\$3,749,252
Fund Balance	\$(565,677)	—	—	—	—	—
General Fund Contributions	\$84,203,690	\$93,798,764	\$98,528,878	\$103,855,379	\$100,011,231	\$6,212,467
General Fund - Restricted Fund Balance	—	—	—	\$250,000	\$250,000	\$250,000
Total Source of Funds	\$134,916,529	\$147,522,447	\$151,935,094	\$161,578,314	\$157,734,166	\$10,211,719

Summary of Recommendation

The Recommended Budget for the Sheriff's department includes \$157,734,166 in total appropriations financed by \$57,472,935 in revenues, \$100,011,231 in General Fund Contributions (GFC), and \$250,000 in cancellation of reserves. This represents an increase in appropriations of \$10,211,719 over the FY 2022-23 budget. The increase in appropriations is from cost drivers experienced countywide, including higher costs associated with employee wages from COLA and step increases, higher employee pension costs and health insurance including jail inmate healthcare costs.

The Recommended Budget includes a total of 468 positions and an augmentation funded through ARPA in the amount of \$3,380,255 to cover the increase in cost for the jail inmate healthcare agreement that could not be met with AB109 or departmental funding.

Budget Impacts

The FY 2023-24 Recommended Budget does not include requested new positions, which will have a negative impact on the County's ability to remove itself from the Hernandez Federal Settlement Agreement.

Sheriff's augmentation requests amounting to \$3,844,148 were not included in the Recommended Budget. This budget augmentation request is needed to fund a) peace officers to be assigned to the Corrections Operations Bureau focused on the Hernandez Federal Settlement Agreement, b) the development of a Jail Compliance Division to increase oversight of County efforts pertaining to the Hernandez Federal Settlement Agreement, c) one-time unplanned equipment upfit fees to place new patrol SUVs into service due to the elimination of our current patrol vehicle by the manufacturer, d) one-

time unplanned increase to the Vehicle Replacement Fund to ensure future patrol vehicle replacement costs are budgeted, e) to add additional personnel to professional staff units in need of support due to increased community engagement and, f) capital improvements for the Public Safety Building. Our office is still suffering a high vacancy rate which puts pressure on existing personnel to cover mandatory minimum shift coverage and to ensure timely investigations for serious crimes against persons and property. Additionally, considering the new pay rates with the recently ratified memorandums of understanding, every hour of overtime will be more expensive in the coming year.

The number of deputies patrolling the unincorporated areas of Monterey County is currently at historic lows. Staffing levels allow for the basic 911 response, but not the community service response the Sheriff's Office is often called upon. Response time delays will occur due to limited resources and nature of service call prioritization. Low level crimes like illegal dumping, loud noise, and illegal parking; along with non-crimes like homeless encampments will be the lowest priority and will receive little to no enforcement attention, which is not in line with community expectations, until patrol staffing begins to increase.

The Recommended Budget does not provide flexibility to address potential contingencies, such as payouts for accrued leave credits upon separation from County service or costs associated with an aging Jail facility and Administrative and Coroner's building. Unplanned maintenance and equipment repair for the jail facility have been an annual occurrence. Should these unbudgeted costs arise during the fiscal year, the department will be left with no other option but to request additional appropriations from the Board to cover these necessary but unbudgeted expenditures. Temporary staffing to support the Sheriff's operations was not included in the budget. When professional staff positions become vacant, temporary employees are necessary to continue serving the public and manage workloads without significant delays. This budget does not account for current higher fuel prices which now appear to be the norm and the fuel budget will be challenged to meet the organization's need of 3800 square miles of land to serve.

Prior Year Accomplishments

In the prior year, the Sheriff's Office oversaw the law enforcement response to the flood disasters impacting every region in the County.

The Guardian RFID system previously funded by AB109 to automate and track inmate movement, inmate programs, and safety checks and help streamline the auditing and reporting requirements for the Hernandez lawsuit was expanded to track additional functions that will aid in lawsuit compliance. Since becoming fully operational the jail has experienced an increase in the completeness, timeliness, and thoroughness of welfare checks.

Renewed the contract with Wellpath to provide healthcare services at the Monterey County Jail.

Budget Year Goals

As of the writing of this narrative, the Sheriff's Office plans to continue to seek funding of peace officer positions to continue its core functions and comply with mandates, maintain adequate jail staffing, and increase the number of patrol deputies working out in the community. This includes developing the Jail Compliance Division to increase staff assigned to the Hernandez Federal Settlement Agreement by 500%, which allows for greater oversight of jail operations. In 2015, 25 patrol deputies were reassigned to the jail in response to the Hernandez settlement and staffing in the jail unit increased by 13 positions, including 6 custody and control specialists and two sergeants. In addition, with increased staffing, greater collaboration can occur with the jail healthcare provider, County Counsel and the five federal monitors.

Pending Issues

The Public Safety Building remains an issue due to lack of basic security, such as ballistic glass at the front counter, doors that secure properly, and protective measures to prevent unauthorized access to the roof of the building. An intruder can gain access to the Public Safety Building by simply scaling a one-foot wall. This is a huge security risk. Both Sheriff's sub-stations have antiquated security systems as well. The Jail perimeter security fencing is substandard and falling, which endangers employees and risks escape from inmates. The Jail also suffers from large-scale infrastructure failures, such as boilers and generators. The HVAC system in the Public Safety Building and Jail is regularly failing. Employees are forced to use portable heaters in the winter and prop open doors in the summer. Electrical cords from heaters and fans pose a trip and fall hazard. The use of portable heaters to warm very cold areas poses a risk in work areas that contain chemicals, such as the crime lab. The opening of doors poses a risk to the security of the building and various work areas. Budgetary problems prevent the office from addressing safety and security at the Office.

The State Trial Court funding remains a pending item. Court security funding is a top legislative priority for the California State Sheriff's Association (CSSA). The Sheriff's Office is working with the CSSA legislative team to lobby for additional funding. The Office has been and will continue to work with local Superior Court staff to ensure the Office's staffing falls within the funding allotment given by the State.

Policy Considerations

There are no policy considerations.

Appropriation Expenditure Detail

	Prior Year 2021-2022	Adopted Budget 2022-2023	CY Estimate 2022-2023	Requested Budget 2023-2024	Recommended Budget 2023-2024	Recommended Change from Adopted	Fund Code	Budget Unit Code
Civil (SHE001)	797,527	885,485	663,141	1,064,723	1,064,723	179,238	001	8225
Professional Standards (SHE001)	1,990,803	2,227,593	2,570,053	2,713,548	2,713,548	485,955	001	8227
Records and Warrants (SHE001)	2,582,994	3,013,650	3,095,586	3,378,924	3,087,907	74,257	001	8229
Custody Administration (SHE006)	0	188,000	188,000	342,838	342,838	154,838	022	8233
Court Services (SHE003)	5,285,979	5,441,843	4,918,483	5,644,079	5,644,079	202,236	001	8234
Court Services (SHE006)	4,279,395	4,800,000	4,859,483	5,417,357	5,417,357	617,357	022	8234
Transportation (SHE003)	15,238	0	0	0	0	0	001	8235
Jail Operations and Administration (SHE003)	56,261,028	62,295,945	64,253,295	64,810,645	63,336,366	1,040,421	001	8238
Jail Operations and Administration (SHE006)	810,663	615,000	615,000	613,463	613,463	(1,537)	022	8238
Inmate Programs (SHE003)	1,096,358	1,016,916	993,935	1,050,265	1,050,265	33,349	001	8239
Enforcement Operations and Administration (SHE001)	28,277,869	33,490,602	33,606,124	35,182,010	33,853,010	362,408	001	8242
Enforcement Operations and Administration (SHE006)	299,571	475,000	475,000	652,300	652,300	177,300	022	8242
Coroner & Investigation (SHE001)	8,419,478	9,439,437	9,535,465	10,328,522	10,188,522	749,085	001	8245
Coroner & Investigation (SHE006)	268,645	420,000	420,000	416,280	416,280	(3,720)	022	8245
Narcotics (SHE006)	175,400	220,000	220,000	271,793	271,793	51,793	022	8246
Community Services and Special Enforcement (SHE001)	3,902,794	2,748,518	3,321,563	2,439,883	2,439,883	(308,635)	001	8250
Administration and Indirect Costs (SHE001)	10,058,104	9,529,949	9,882,687	12,050,232	11,440,380	1,910,431	001	8273
Inmate Medical Program (SHE003)	10,394,682	10,714,509	12,317,279	15,201,452	15,201,452	4,486,943	001	8532
Subtotal	\$134,916,529	\$147,522,447	\$151,935,094	\$161,578,314	\$157,734,166	\$10,211,719		

Budget Units

	Prior Year 2021-2022	Adopted Budget 2022-2023	CY Estimate 2022-2023	Requested Budget 2023-2024	Recommended Budget 2023-2024	Recommended Change from Adopted
Civil	\$797,527	\$885,485	\$663,141	\$1,064,723	\$1,064,723	\$179,238
Professional Standards	\$1,990,803	\$2,227,593	\$2,570,053	\$2,713,548	\$2,713,548	\$485,955
Records and Warrants	\$2,582,994	\$3,013,650	\$3,095,586	\$3,378,924	\$3,087,907	\$74,257
Custody Administration	—	\$188,000	\$188,000	\$342,838	\$342,838	\$154,838
Court Services	\$9,565,374	\$10,241,843	\$9,777,966	\$11,061,436	\$11,061,436	\$819,593
Transportation	\$15,238	—	—	—	—	—
Jail Operations and Administration	\$57,071,691	\$62,910,945	\$64,868,295	\$65,424,108	\$63,949,829	\$1,038,884
Inmate Programs	\$1,096,358	\$1,016,916	\$993,935	\$1,050,265	\$1,050,265	\$33,349
Enforcement Operations and Administration	\$28,577,440	\$33,965,602	\$34,081,124	\$35,834,310	\$34,505,310	\$539,708
Coroner & Investigation	\$8,688,123	\$9,859,437	\$9,955,465	\$10,744,802	\$10,604,802	\$745,365
Narcotics	\$175,400	\$220,000	\$220,000	\$271,793	\$271,793	\$51,793
Community Services and Special Enforcement	\$3,902,794	\$2,748,518	\$3,321,563	\$2,439,883	\$2,439,883	\$(308,635)
Administration and Indirect Costs	\$10,058,104	\$9,529,949	\$9,882,687	\$12,050,232	\$11,440,380	\$1,910,431
Inmate Medical Program	\$10,394,682	\$10,714,509	\$12,317,279	\$15,201,452	\$15,201,452	\$4,486,943
Subtotal	\$134,916,529	\$147,522,447	\$151,935,094	\$161,578,314	\$157,734,166	\$10,211,719

Sheriff-Coroner

Adopted FY 2022-23 to Recommended FY 2023-24 Positions

Classification Code	Classification Label	Adopted Budget 2021-2022	Adopted Budget 2022-2023	Recommended Budget 2023-2024	Change
10B05	SHERIFF	1.00	1.00	1.00	0.00
12A10	CHIEF DEPUTY SHERIFF	3.00	3.00	3.00	0.00
12A13	UNDERSHERIFF	1.00	1.00	1.00	0.00
14B01	PERSONNEL ANALYST	1.00	1.00	1.00	0.00
14C30	MANAGEMENT ANALYST II	1.00	1.00	0.00	(1.00)
14C31	MANAGEMENT ANALYST III	3.00	3.00	3.00	0.00
14G02	MANAGEMENT ANALYST I	0.00	1.00	1.00	0.00
14H33	CRIMINAL INTELLIGENCE SPECIALIST	2.00	2.00	2.00	0.00
16F41	DEPARTMENTAL INFORMATION SYSTEMS MANAGER II	1.00	1.00	1.00	0.00
20B11	ACCOUNTANT II	1.00	1.00	1.00	0.00
20B12	ACCOUNTANT III	1.00	1.00	1.00	0.00
20B93	FINANCE MANAGER II	1.00	1.00	1.00	0.00
34E22	FORENSIC EVIDENCE TECHNICIAN	2.00	2.00	2.00	0.00
34E30	SUPERVISING FORENSIC EVIDENCE TECHNICIAN	1.00	1.00	1.00	0.00
34G21	CIVIL PROCESS SERVER	1.00	1.00	1.00	0.00
34P31	VEHICLE ABATEMENT ENFORCEMENT OFFICER	2.00	2.00	2.00	0.00
36A22	DEPUTY SHERIFF-OPERATIONS	111.00	112.00	112.00	0.00
36A23	SHERIFFS SERGEANT	34.00	34.00	34.00	0.00
36A24	SHERIFFS INVESTIGATIVE SERGEANT	3.00	3.00	3.00	0.00
36A81	SHERIFFS CAPTAIN	1.00	1.00	1.00	0.00
36A82	SHERIFFS COMMANDER	9.00	9.00	9.00	0.00
36E21	DEPUTY SHERIFF-CORRECTIONS	154.00	153.00	153.00	0.00
43G05	DIGITAL FORENSIC INVESTIGATOR	1.00	1.00	1.00	0.00
43J09	SENIOR DEPARTMENTAL INFORMATION SYSTEMS COORDINATOR	3.00	3.00	3.00	0.00
43J15	SUPERVISING DEPARTMENTAL INFORMATION SYSTEMS COORDINATOR	1.00	1.00	1.00	0.00
50S01	FORENSIC AUTOPSY TECHNICIAN	1.00	2.00	2.00	0.00
60G54	SHERIFF'S WORK ALTERNATIVE SPECIALIST	4.00	4.00	4.00	0.00
60I02	PROGRAM MANAGER II	0.00	0.00	1.00	1.00
60S21	CRIME PREVENTION SPECIALIST	1.00	1.00	1.00	0.00
70F80	SENIOR STOREKEEPER	1.00	1.00	1.00	0.00
70K92	SHERIFFS CORRECTIONAL COOK II	5.00	5.00	5.00	0.00
70N10	INMATE SERVICES SPECIALIST	5.00	5.00	5.00	0.00
72A40	SENIOR INMATE SERVICES SPECIALIST	1.00	1.00	1.00	0.00
72C25	VEHICLE MAINTENANCE COORDINATOR	1.00	1.00	1.00	0.00
80A32	SENIOR SECRETARY	1.00	1.00	1.00	0.00
80A34	SENIOR SECRETARY-CONFIDENTIAL	1.00	1.00	1.00	0.00
80A99	ADMINISTRATIVE SECRETARY-CONFIDENTIAL	1.00	1.00	1.00	0.00
80E22	OFFICE ASSISTANT III	3.00	3.00	3.00	0.00
80H25	MEDICAL TRANSCRIPTIONIST II	1.00	0.00	0.00	0.00
80I01	SENIOR CIVIL CLERK	1.00	1.00	1.00	0.00
80I06	SHERIFFS PROPERTY TECHNICIAN	2.00	2.00	2.00	0.00
80I07	CORRECTIONS SPECIALIST	11.00	11.00	11.00	0.00
80I08	SENIOR CORRECTIONS SPECIALIST	3.00	3.00	3.00	0.00
80I10	CUSTODY AND CONTROL SPECIALIST	47.00	47.00	47.00	0.00
80I15	SHERIFFS RECORDS SPECIALIST I	2.00	2.00	2.00	0.00
80I16	SHERIFFS RECORDS SPECIALIST II	18.00	18.00	18.00	0.00
80I17	SENIOR SHERIFFS RECORDS SPECIALIST	5.00	5.00	5.00	0.00
80I20	SHERIFFS RECORDS SUPERVISOR	4.00	4.00	4.00	0.00

Adopted FY 2022-23 to Recommended FY 2023-24 Positions

Classification Code	Classification Label	Adopted Budget 2021-2022	Adopted Budget 2022-2023	Recommended Budget 2023-2024	Change
80J20	ACCOUNTING CLERICAL SUPERVISOR	1.00	1.00	1.00	0.00
80J21	ACCOUNT CLERK	1.00	1.00	1.00	0.00
80J22	SENIOR ACCOUNT CLERK	3.00	3.00	3.00	0.00
80J30	ACCOUNTING TECHNICIAN	4.00	4.00	4.00	0.00
Total		467.00	468.00	468.00	0.00

Augmentation Requests

Request Code	Request Name	Ranking Type Name	Requested Amount	Requested FTE	Recommended Budget	Recommended FTE
2300-8229-001-AUG010	New Position Sheriff's Records Director	Request New Position	187,615	1.00	-	-
2300-8229-001-AUG012	New Position Sheriff's Records Specialist II	Request New Position	103,402	1.00	-	-
2300-8238-001-AUG005	Restore Funding of 5 Deputy Sheriff-Corrections	Status Quo Other	949,129	-	-	-
2300-8238-001-AUG006	New Position Sheriff's Commander	Request New Position	288,242	1.00	-	-
2300-8238-001-AUG007	New Position Sheriff's Sergeant	Request New Position	236,908	1.00	-	-
2300-8242-001-AUG015	UpFit of 21 New Vehicles	New Program/Service w/ Outside Funding	700,000	-	-	-
2300-8242-001-AUG016	VRP Catch Up for 35 Patrol Vehicles	Contribution to Other Funds	629,000	-	-	-
2300-8245-001-AUG013	New Cannabis Vehicle	New Program/Service w/ General Fund Funding	70,000	-	-	-
2300-8245-001-AUG014	New Cannabis Vehicle	New Program/Service w/ General Fund Funding	70,000	-	-	-
2300-8273-001-AUG008	New Position Accountant III	Request New Position	165,809	1.00	-	-
2300-8273-001-AUG009	New Position Accounting Technician	Request New Position	107,906	1.00	-	-
2300-8273-001-AUG011	New Position DISC	Request New Position	136,137	1.00	-	-
2300-8273-001-AUG017	Generator for the Sheriff's Admin Building	Capital Improvements	200,000	-	-	-
2300-8532-001-AUG002	Board Approved CFMG (WellPath) Contract Increase	Status Quo Other	3,380,255	-	3,380,255	-
Grand Total:			\$7,224,403	7.00	\$3,380,255	-

Sheriff-Coroner

Civil

(Budget Unit 8225—Fund 001—Appropriation Unit SHE001)

Use of Funds

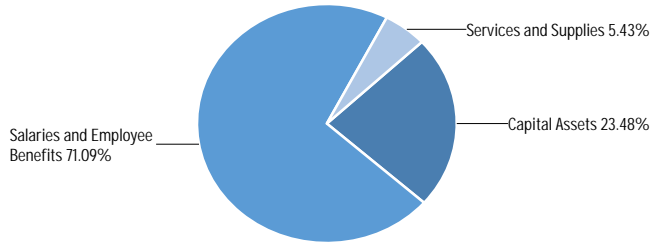

Source of Funds

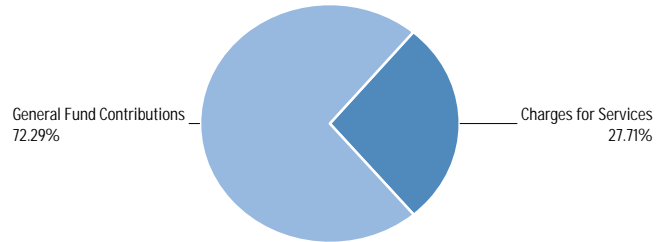

Use of Funds

Expenditures	Prior Year 2021-2022	Adopted Budget 2022-2023	CY Estimate 2022-2023	Requested Budget 2023-2024	Recommended Budget 2023-2024	Recommended Change from Adopted
Salaries and Employee Benefits	\$673,184	\$714,362	\$615,572	\$756,911	\$756,911	\$42,549
Services and Supplies	\$124,343	\$51,123	\$47,569	\$57,812	\$57,812	\$6,689
Capital Assets	—	\$120,000	—	\$250,000	\$250,000	\$130,000
Subtotal	\$797,527	\$885,485	\$663,141	\$1,064,723	\$1,064,723	\$179,238

Source of Funds

Revenues	Prior Year 2021-2022	Adopted Budget 2022-2023	CY Estimate 2022-2023	Requested Budget 2023-2024	Recommended Budget 2023-2024	Recommended Change from Adopted
Charges for Services	\$134,662	\$295,000	\$202,208	\$295,000	\$295,000	—
Miscellaneous Revenues	\$375	—	\$261	\$282	\$282	\$282
Subtotal	\$135,037	\$295,000	\$202,469	\$295,282	\$295,282	\$282
General Fund Contributions	\$662,490	\$590,485	\$460,672	\$519,441	\$519,441	\$(71,044)
Restricted Fund Balance	—	—	—	\$250,000	\$250,000	\$250,000
Total Source of Funds	\$797,527	\$885,485	\$663,141	\$1,064,723	\$1,064,723	\$179,238

Unit Description

This unit processes and serves civil procedures including small claims, earnings withholding orders, real property levies as well as bank levies and evictions. All these services are provided throughout the County including locations inside the incorporated cities.

Recommended FY 2023-24 Positions

Classification Code	Classification Label	FTE
14G02	MANAGEMENT ANALYST I	1.00
34G21	CIVIL PROCESS SERVER	1.00
36A22	DEPUTY SHERIFF-OPERATIONS	1.00
80I01	SENIOR CIVIL CLERK	1.00
80J21	ACCOUNT CLERK	1.00
80J30	ACCOUNTING TECHNICIAN	1.00
Total		6.00

Professional Standards

(Budget Unit 8227—Fund 001—Appropriation Unit SHE001)

Use of Funds

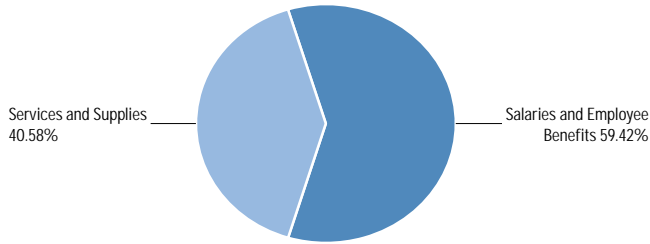

Source of Funds

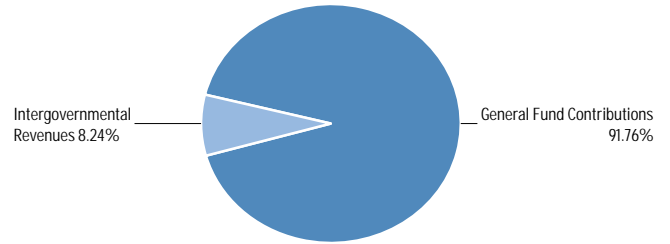

Use of Funds

Expenditures	Prior Year 2021-2022	Adopted Budget 2022-2023	CY Estimate 2022-2023	Requested Budget 2023-2024	Recommended Budget 2023-2024	Recommended Change from Adopted
Salaries and Employee Benefits	\$1,450,252	\$1,245,633	\$1,637,779	\$1,612,371	\$1,612,371	\$366,738
Services and Supplies	\$540,551	\$981,960	\$932,274	\$1,101,177	\$1,101,177	\$119,217
Subtotal	\$1,990,803	\$2,227,593	\$2,570,053	\$2,713,548	\$2,713,548	\$485,955

Source of Funds

Revenues	Prior Year 2021-2022	Adopted Budget 2022-2023	CY Estimate 2022-2023	Requested Budget 2023-2024	Recommended Budget 2023-2024	Recommended Change from Adopted
Intergovernmental Revenues	\$16,225	\$120,250	\$223,530	\$223,530	\$223,530	\$103,280
Charges for Services	\$210	—	\$196	\$147	\$147	\$147
Miscellaneous Revenues	\$15	—	—	—	—	—
Subtotal	\$16,450	\$120,250	\$223,726	\$223,677	\$223,677	\$103,427
General Fund Contributions	\$1,974,353	\$2,107,343	\$2,346,327	\$2,489,871	\$2,489,871	\$382,528
Total Source of Funds	\$1,990,803	\$2,227,593	\$2,570,053	\$2,713,548	\$2,713,548	\$485,955

Unit Description

This unit oversees internal affairs, applicant and volunteer background checks, training, and public information requests. The unit commander is the Sheriff's Office Equal Employment Officer and the Loss Prevention Committee Chair.

Recommended FY 2023-24 Positions

Classification Code	Classification Label	FTE
36A22	DEPUTY SHERIFF-OPERATIONS	1.00
36A23	SHERIFFS SERGEANT	2.00
36A82	SHERIFFS COMMANDER	1.00
36E21	DEPUTY SHERIFF-CORRECTIONS	1.00
80A32	SENIOR SECRETARY	1.00
80E22	OFFICE ASSISTANT III	1.00
Total		7.00

Records and Warrants

(Budget Unit 8229—Fund 001—Appropriation Unit SHE001)

Use of Funds

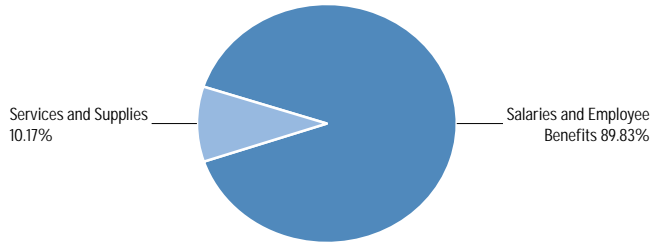

Source of Funds

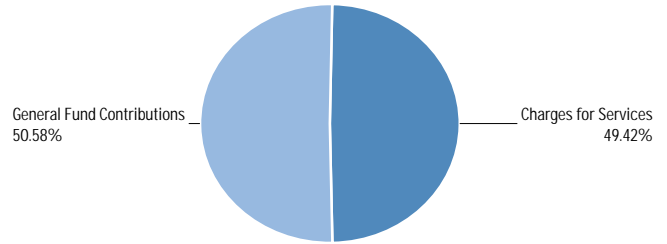

Use of Funds

Expenditures	Prior Year 2021-2022	Adopted Budget 2022-2023	CY Estimate 2022-2023	Requested Budget 2023-2024	Recommended Budget 2023-2024	Recommended Change from Adopted
Salaries and Employee Benefits	\$2,554,468	\$2,672,515	\$2,783,795	\$3,065,016	\$2,773,999	\$101,484
Services and Supplies	\$36,302	\$341,135	\$311,791	\$313,908	\$313,908	\$(27,227)
Other Charges	\$(7,776)	—	—	—	—	—
Subtotal	\$2,582,994	\$3,013,650	\$3,095,586	\$3,378,924	\$3,087,907	\$74,257

Source of Funds

Revenues	Prior Year 2021-2022	Adopted Budget 2022-2023	CY Estimate 2022-2023	Requested Budget 2023-2024	Recommended Budget 2023-2024	Recommended Change from Adopted
Charges for Services	\$1,513,215	\$1,489,076	\$1,488,718	\$1,525,936	\$1,525,936	\$36,860
Subtotal	\$1,513,215	\$1,489,076	\$1,488,718	\$1,525,936	\$1,525,936	\$36,860
General Fund Contributions	\$1,069,779	\$1,524,574	\$1,606,868	\$1,852,988	\$1,561,971	\$37,397
Total Source of Funds	\$2,582,994	\$3,013,650	\$3,095,586	\$3,378,924	\$3,087,907	\$74,257

Unit Description

This unit provides support to all bureaus of the Sheriff's Office and all law enforcement and criminal justice agencies in Monterey County on a 24/7 basis. Functions include: processing live scan fingerprinting for the general public, providing arrest records and crime reports, submitting the State Department of Justice (DOJ) required statistics, entering restraining orders, and operating the public information counter. The Warrants Section is the central repository for all criminal, traffic and juvenile warrants issued in Monterey County. The unit enters and maintains all warrants and they are confirmed by the unit before being served.

Recommended FY 2023-24 Positions

Classification Code	Classification Label	FTE
80115	SHERIFFS RECORDS SPECIALIST I	2.00
80116	SHERIFFS RECORDS SPECIALIST II	18.00
80117	SENIOR SHERIFFS RECORDS SPECIALIST	5.00
80120	SHERIFFS RECORDS SUPERVISOR	2.00
Total		27.00

Custody Administration

(Budget Unit 8233—Fund 022—Appropriation Unit SHE006)

Use of Funds

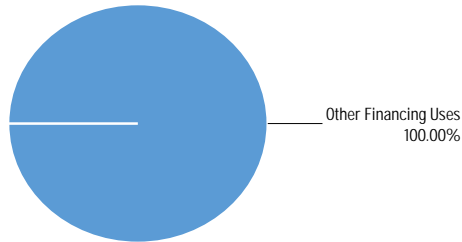

Source of Funds

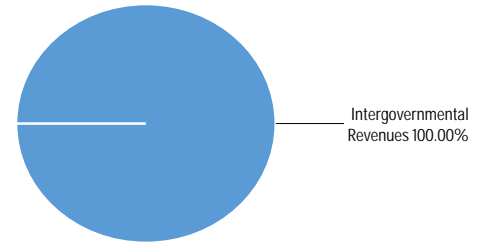

Use of Funds

Expenditures	Prior Year 2021-2022	Adopted Budget 2022-2023	CY Estimate 2022-2023	Requested Budget 2023-2024	Recommended Budget 2023-2024	Recommended Change from Adopted
Other Financing Uses	—	\$188,000	\$188,000	\$342,838	\$342,838	\$154,838
Subtotal	—	\$188,000	\$188,000	\$342,838	\$342,838	\$154,838

Source of Funds

Revenues	Prior Year 2021-2022	Adopted Budget 2022-2023	CY Estimate 2022-2023	Requested Budget 2023-2024	Recommended Budget 2023-2024	Recommended Change from Adopted
Intergovernmental Revenues	—	\$188,000	\$188,000	\$342,838	\$342,838	\$154,838
Subtotal	—	\$188,000	\$188,000	\$342,838	\$342,838	\$154,838
Fund Balance	—	—	—	—	—	—
Total Source of Funds	—	\$188,000	\$188,000	\$342,838	\$342,838	\$154,838

Unit Description

The FY 2011-12 State budget enacted a shift or "realignment" of State program responsibilities and revenues to local governments. To support the various realigned criminal justice, mental health, and social services programs, the Legislature passed Assembly Bill 118 (Chapter 40, Statutes of 2011). AB 118 created the new Local

Revenue Fund 2011, in which a portion of State sales tax and vehicle license fee revenues are deposited and provided an accounting structure. For transparency in reporting, the County established Fund 022 to account for all public safety realignment revenues related to the Local Revenue Fund. Operating transfers occur between the General Fund and Fund 022 for realigned programs' payments.

Court Services

(Budget Unit 8234—Fund 001—Appropriation Unit SHE003)

Use of Funds

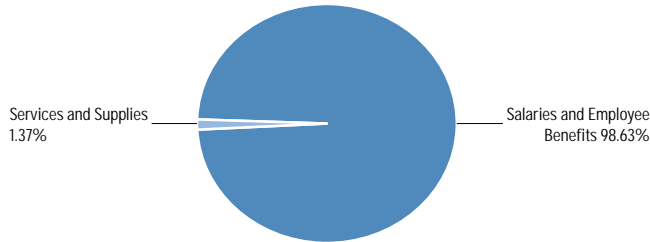

Source of Funds

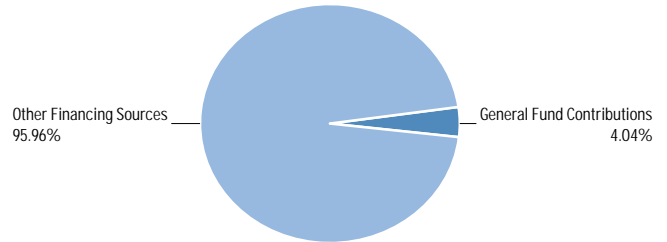

Use of Funds

Expenditures	Prior Year 2021-2022	Adopted Budget 2022-2023	CY Estimate 2022-2023	Requested Budget 2023-2024	Recommended Budget 2023-2024	Recommended Change from Adopted
Salaries and Employee Benefits	\$4,661,783	\$5,365,300	\$4,841,940	\$5,566,521	\$5,566,521	\$201,221
Services and Supplies	\$334,712	\$76,543	\$76,543	\$77,558	\$77,558	\$1,015
Other Charges	\$289,484	—	—	—	—	—
Subtotal	\$5,285,979	\$5,441,843	\$4,918,483	\$5,644,079	\$5,644,079	\$202,236

Source of Funds

Revenues	Prior Year 2021-2022	Adopted Budget 2022-2023	CY Estimate 2022-2023	Requested Budget 2023-2024	Recommended Budget 2023-2024	Recommended Change from Adopted
Miscellaneous Revenues	—	—	\$59,000	—	—	—
Other Financing Sources	\$4,279,395	\$4,800,000	\$4,859,483	\$5,415,931	\$5,415,931	\$615,931
Subtotal	\$4,279,395	\$4,800,000	\$4,918,483	\$5,415,931	\$5,415,931	\$615,931
General Fund Contributions	\$1,006,584	\$641,843	—	\$228,148	\$228,148	\$(413,695)
Total Source of Funds	\$5,285,979	\$5,441,843	\$4,918,483	\$5,644,079	\$5,644,079	\$202,236

Unit Description

This unit manages most aspects of security services for the Superior Court of California in Monterey County. The Court has 19 judicial officers located at five court locations including Salinas, Monterey, Marina, and the Juvenile and Drug Court.

Recommended FY 2023-24 Positions

Classification Code	Classification Label	FTE
36A23	SHERIFFS SERGEANT	2.00
36E21	DEPUTY SHERIFF-CORRECTIONS	20.00
Total		22.00

Court Services

(Budget Unit 8234—Fund 022—Appropriation Unit SHE006)

Use of Funds

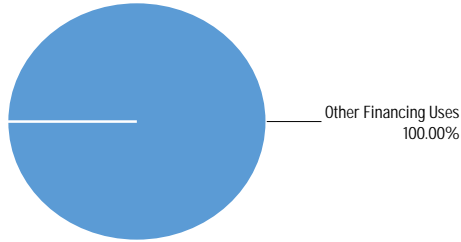

Source of Funds

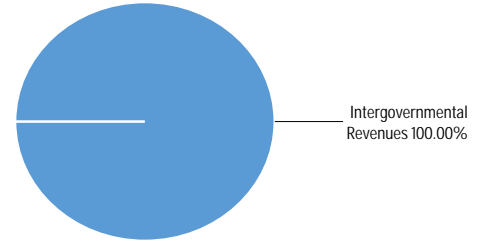

Use of Funds

Expenditures	Prior Year 2021-2022	Adopted Budget 2022-2023	CY Estimate 2022-2023	Requested Budget 2023-2024	Recommended Budget 2023-2024	Recommended Change from Adopted
Other Financing Uses	\$4,279,395	\$4,800,000	\$4,859,483	\$5,417,357	\$5,417,357	\$617,357
Subtotal	\$4,279,395	\$4,800,000	\$4,859,483	\$5,417,357	\$5,417,357	\$617,357

Source of Funds

Revenues	Prior Year 2021-2022	Adopted Budget 2022-2023	CY Estimate 2022-2023	Requested Budget 2023-2024	Recommended Budget 2023-2024	Recommended Change from Adopted
Intergovernmental Revenues	\$4,881,728	\$4,800,000	\$4,859,483	\$5,417,357	\$5,417,357	\$617,357
Subtotal	\$4,881,728	\$4,800,000	\$4,859,483	\$5,417,357	\$5,417,357	\$617,357
Fund Balance	\$(602,333)	—	—	—	—	—
Total Source of Funds	\$4,279,395	\$4,800,000	\$4,859,483	\$5,417,357	\$5,417,357	\$617,357

Unit Description

The FY 2011-12 State budget enacted a shift or "realignment" of State program responsibilities and revenues to local governments. To support the various realigned criminal justice, mental health, and social services programs, the Legislature passed Assembly Bill 118 (Chapter 40, Statutes of 2011). AB 118 created the new Local

Revenue Fund 2011, in which a portion of State sales tax and vehicle license fee revenues are deposited, and provided an accounting structure. For transparency in reporting, the County established Fund 022 to account for all public safety realignment revenues related to the Local Revenue Fund. Operating transfers occur between the General Fund and Fund 022 for realigned programs' payments.

Transportation

(Budget Unit 8235—Fund 001—Appropriation Unit SHE003)

Use of Funds	Source of Funds
Intentionally Left Blank	Intentionally Left Blank

Use of Funds

Expenditures	Prior Year 2021-2022	Adopted Budget 2022-2023	CY Estimate 2022-2023	Requested Budget 2023-2024	Recommended Budget 2023-2024	Recommended Change from Adopted
Salaries and Employee Benefits	\$14,246	—	—	—	—	—
Services and Supplies	\$992	—	—	—	—	—
Subtotal	\$15,238	—	—	—	—	—

Source of Funds

Revenues	Prior Year 2021-2022	Adopted Budget 2022-2023	CY Estimate 2022-2023	Requested Budget 2023-2024	Recommended Budget 2023-2024	Recommended Change from Adopted
General Fund Contributions	\$15,238	—	—	—	—	—
Total Source of Funds	\$15,238	—	—	—	—	—

Unit Description

Effective FY 2021-22, this unit was consolidated with Jail Operations and Administration (8238).

Jail Operations and Administration

(Budget Unit 8238—Fund 001—Appropriation Unit SHE003)

Use of Funds

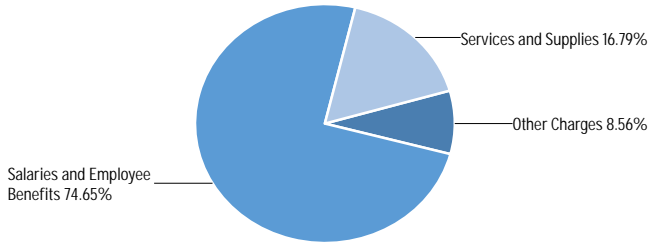

Source of Funds

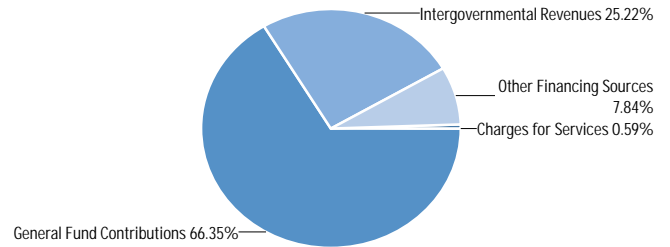

Use of Funds

Expenditures	Prior Year 2021-2022	Adopted Budget 2022-2023	CY Estimate 2022-2023	Requested Budget 2023-2024	Recommended Budget 2023-2024	Recommended Change from Adopted
Salaries and Employee Benefits	\$41,960,049	\$45,695,828	\$47,549,749	\$48,718,254	\$47,243,975	\$1,548,147
Services and Supplies	\$11,086,932	\$10,581,932	\$10,514,361	\$10,627,480	\$10,627,480	\$45,548
Other Charges	\$3,094,104	\$5,908,185	\$5,908,185	\$5,419,911	\$5,419,911	\$(488,274)
Capital Assets	\$119,943	\$110,000	\$281,000	\$45,000	\$45,000	\$(65,000)
Subtotal	\$56,261,028	\$62,295,945	\$64,253,295	\$64,810,645	\$63,336,366	\$1,040,421

Source of Funds

Revenues	Prior Year 2021-2022	Adopted Budget 2022-2023	CY Estimate 2022-2023	Requested Budget 2023-2024	Recommended Budget 2023-2024	Recommended Change from Adopted
Intergovernmental Revenues	\$16,332,433	\$15,612,890	\$15,012,185	\$15,970,184	\$15,970,184	\$357,294
Charges for Services	\$45,608	\$371,998	\$488,033	\$374,988	\$374,988	\$2,990
Miscellaneous Revenues	\$5,424	—	\$3,000	\$3,000	\$3,000	\$3,000
Other Financing Sources	\$4,325,402	\$4,685,242	\$5,235,721	\$4,967,119	\$4,967,119	\$281,877
Subtotal	\$20,708,867	\$20,670,130	\$20,738,939	\$21,315,291	\$21,315,291	\$645,161
General Fund Contributions	\$35,552,161	\$41,625,815	\$43,514,356	\$43,495,354	\$42,021,075	\$395,260
Total Source of Funds	\$56,261,028	\$62,295,945	\$64,253,295	\$64,810,645	\$63,336,366	\$1,040,421

Unit Description

The Corrections Operations Bureau (COB) is managed by a chief, a captain, and commanders who are responsible for all aspects of corrections operations to include, but not limited to inmate care and custody, inmate transportation, court security, inmate programs, contract services administration and all support functions for the Monterey County jail.

This unit is responsible for the care and custody of inmates at the County Jail in compliance with Title 15, Minimum Standards. This unit oversees and monitors realigned prisoners as a result of AB 109 and classifies inmates and assigns appropriate housing to those arrested in the County.

The Compliance and Administration Division develops policies and procedures, coordinates with County Counsel and other agencies on policies, procedures, claims and lawsuit response. This unit ensures that all mandated inspections are completed and develops remediation

plans for any noted deficiencies. This unit coordinates all new jail construction initiatives for the Sheriff's Office and oversees the inmate phone contract as well. In addition, this unit performs regular compliance monitoring on many bureau functions and provides recommendations for improvements when necessary.

This unit manages the inmate food service and commissary contract with Aramark, purchasing equipment and supplies for the Corrections Operations Bureau, general maintenance and upkeep of the jail facility and facility improvement projects.

This unit also manages the jail records unit, which maintains all custody records and is the point of contact for the public at the jail and the Work Alternative Program (WAP) which processes clients into the program, conducts site inspections, and books inmates for the Probation Department's Home Confinement Program and the District Attorney's Office. The WAP alleviates jail crowding by allowing eligible candidates to perform community service hours in lieu of jail time.

Recommended FY 2023-24 Positions

Classification Code	Classification Label	FTE
12A10	CHIEF DEPUTY SHERIFF	1.00
14C31	MANAGEMENT ANALYST III	1.00
14H33	CRIMINAL INTELLIGENCE SPECIALIST	1.00
36A23	SHERIFFS SERGEANT	17.00
36A81	SHERIFFS CAPTAIN	1.00
36A82	SHERIFFS COMMANDER	3.00
36E21	DEPUTY SHERIFF-CORRECTIONS	132.00
60G54	SHERIFF'S WORK ALTERNATIVE SPECIALIST	4.00
60I02	PROGRAM MANAGER II	1.00

Recommended FY 2023-24 Positions

Classification Code	Classification Label	FTE
70F80	SENIOR STOREKEEPER	1.00
70K92	SHERIFFS CORRECTIONAL COOK II	5.00
70N10	INMATE SERVICES SPECIALIST	1.00
80E22	OFFICE ASSISTANT III	1.00
80I07	CORRECTIONS SPECIALIST	11.00
80I08	SENIOR CORRECTIONS SPECIALIST	3.00
80I10	CUSTODY AND CONTROL SPECIALIST	47.00
80I20	SHERIFFS RECORDS SUPERVISOR	2.00
Total		232.00

Jail Operations and Administration

(Budget Unit 8238—Fund 022—Appropriation Unit SHE006)

Use of Funds

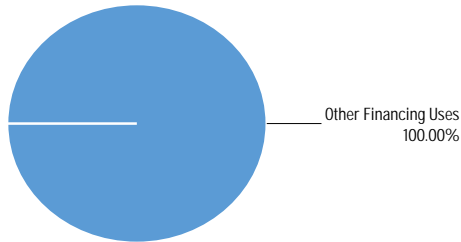

Source of Funds

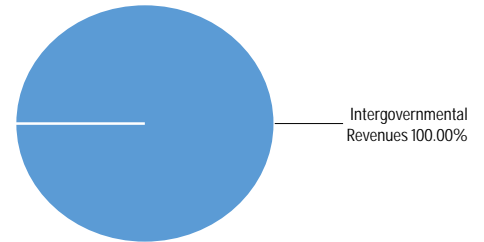

Use of Funds

Expenditures	Prior Year 2021-2022	Adopted Budget 2022-2023	CY Estimate 2022-2023	Requested Budget 2023-2024	Recommended Budget 2023-2024	Recommended Change from Adopted
Other Financing Uses	\$810,663	\$615,000	\$615,000	\$613,463	\$613,463	\$(1,537)
Subtotal	\$810,663	\$615,000	\$615,000	\$613,463	\$613,463	\$(1,537)

Source of Funds

Revenues	Prior Year 2021-2022	Adopted Budget 2022-2023	CY Estimate 2022-2023	Requested Budget 2023-2024	Recommended Budget 2023-2024	Recommended Change from Adopted
Intergovernmental Revenues	\$810,663	\$615,000	\$615,000	\$613,463	\$613,463	\$(1,537)
Subtotal	\$810,663	\$615,000	\$615,000	\$613,463	\$613,463	\$(1,537)
Fund Balance	—	—	—	—	—	—
Total Source of Funds	\$810,663	\$615,000	\$615,000	\$613,463	\$613,463	\$(1,537)

Unit Description

The FY 2011-12 State budget enacted a shift or "realignment" of State program responsibilities and revenues to local governments. To support the various realigned criminal justice, mental health, and social services programs, the Legislature passed Assembly Bill 118 (Chapter 40, Statutes of 2011). AB 118 created the new Local

Revenue Fund 2011, in which a portion of State sales tax and vehicle license fee revenues are deposited, and provided an accounting structure. For transparency in reporting, the County established Fund 022 to account for all public safety realignment revenues related to the Local Revenue Fund. Operating transfers occur between the General Fund and Fund 022 for realigned program's payments.

Inmate Programs

(Budget Unit 8239—Fund 001—Appropriation Unit SHE003)

Use of Funds

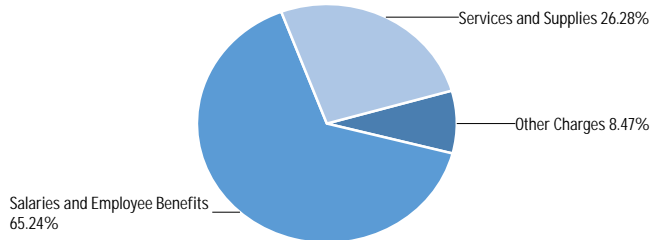

Source of Funds

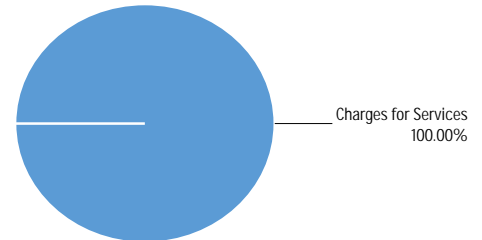

Use of Funds

Expenditures	Prior Year 2021-2022	Adopted Budget 2022-2023	CY Estimate 2022-2023	Requested Budget 2023-2024	Recommended Budget 2023-2024	Recommended Change from Adopted
Salaries and Employee Benefits	\$657,477	\$672,063	\$634,082	\$685,216	\$685,216	\$13,153
Services and Supplies	\$373,089	\$225,408	\$240,408	\$276,049	\$276,049	\$50,641
Other Charges	\$65,792	\$119,445	\$119,445	\$89,000	\$89,000	\$(30,445)
Subtotal	\$1,096,358	\$1,016,916	\$993,935	\$1,050,265	\$1,050,265	\$33,349

Source of Funds

Revenues	Prior Year 2021-2022	Adopted Budget 2022-2023	CY Estimate 2022-2023	Requested Budget 2023-2024	Recommended Budget 2023-2024	Recommended Change from Adopted
Charges for Services	\$1,094,426	\$1,027,646	\$993,935	\$1,050,265	\$1,050,265	\$22,619
Miscellaneous Revenues	\$274	—	—	—	—	—
Subtotal	\$1,094,700	\$1,027,646	\$993,935	\$1,050,265	\$1,050,265	\$22,619
General Fund Contributions	\$1,658	\$(10,730)	—	—	—	\$10,730
Total Source of Funds	\$1,096,358	\$1,016,916	\$993,935	\$1,050,265	\$1,050,265	\$33,349

Unit Description

This unit oversees all in-custody and custody alternative programs in the County Jail system. This includes the Inmate Welfare Fund and associated programs, such as educational programs, occupational training, religious instruction, individual/family services, and mail and library services. More than 255 volunteers support this activity.

Recommended FY 2023-24 Positions

Classification Code	Classification Label	FTE
70N10	INMATE SERVICES SPECIALIST	4.00
72A40	SENIOR INMATE SERVICES SPECIALIST	1.00
Total		5.00

Enforcement Operations and Administration

(Budget Unit 8242—Fund 001—Appropriation Unit SHE001)

Use of Funds

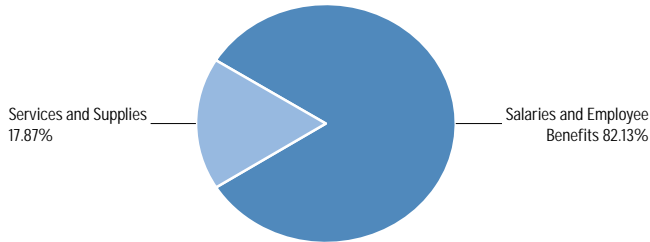

Source of Funds

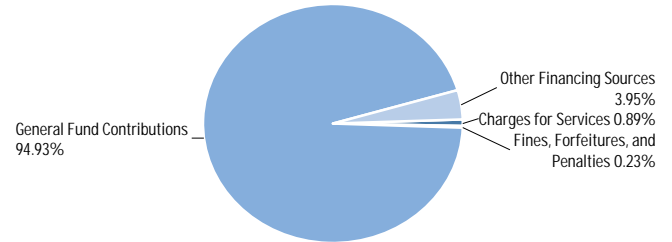

Sheriff-Coroner

Use of Funds

Expenditures	Prior Year 2021-2022	Adopted Budget 2022-2023	CY Estimate 2022-2023	Requested Budget 2023-2024	Recommended Budget 2023-2024	Recommended Change from Adopted
Salaries and Employee Benefits	\$25,028,228	\$27,974,332	\$27,515,952	\$27,804,519	\$27,804,519	\$(169,813)
Services and Supplies	\$3,249,642	\$5,516,270	\$6,090,172	\$7,377,491	\$6,048,491	\$532,221
Subtotal	\$28,277,869	\$33,490,602	\$33,606,124	\$35,182,010	\$33,853,010	\$362,408

Source of Funds

Revenues	Prior Year 2021-2022	Adopted Budget 2022-2023	CY Estimate 2022-2023	Requested Budget 2023-2024	Recommended Budget 2023-2024	Recommended Change from Adopted
Fines, Forfeitures, and Penalties	\$47,765	\$76,004	\$36,107	\$77,298	\$77,298	\$1,294
Intergovernmental Revenues	\$23,622	\$427,961	\$23,631	\$23,631	\$23,631	\$(404,330)
Charges for Services	\$218,835	\$383,351	\$170,000	\$299,861	\$299,861	\$(83,490)
Miscellaneous Revenues	\$74,592	—	\$5,000	\$5,000	\$5,000	\$5,000
Other Financing Sources	\$914,304	\$1,126,000	\$984,921	\$1,337,273	\$1,337,273	\$211,273
Subtotal	\$1,279,117	\$2,013,316	\$1,219,659	\$1,743,063	\$1,743,063	\$(270,253)
General Fund Contributions	\$26,998,752	\$31,477,286	\$32,386,465	\$33,438,947	\$32,109,947	\$632,661
Total Source of Funds	\$28,277,869	\$33,490,602	\$33,606,124	\$35,182,010	\$33,853,010	\$362,408

Unit Description

This unit is managed by a chief and commanders who are responsible for all aspects of enforcement operations including patrol, investigations, special operations and all support functions. This unit also provides general and specialized support to other law enforcement agencies within the County.

The Enforcement Operations and Administration Division also oversees the management of the three patrol stations. The Central Patrol Station covers the area most affected by crimes (Pajaro, Las Lomas, Castroville and Prunedale) and specifically violent crimes with the highest number of gang members. The station is home to the highest number of assigned staff and therefore supplies the highest number of deputies to special details that includes natural disasters, major crimes, special events and major enforcement actions in local

cities such as Salinas. This station also trains all the new deputies who are assigned to the Patrol Division.

The Coastal Patrol Station serves the designated areas of unincorporated Carmel, Carmel Valley, Pebble Beach, the Highlands, Big Sur, Cachagua, and the Highway 68 corridor from Laureles Grade to Highway 1. The South County Station patrols the largest geographical area, with responsibility over 1,800 square miles of Monterey County's area (55%) divided into three patrol beats. The station provides coverage of southern Monterey County from 5th Street, Gonzales south to the San Luis Obispo County line, and west to the ridgeline of the Santa Lucia mountain range. The US Army and California National Guard have major installations at Fort Hunter Liggett and Camp Roberts. This area also contains a large portion of the Los Padres National Forest.

Recommended FY 2023-24 Positions

Classification Code	Classification Label	FTE
12A10	CHIEF DEPUTY SHERIFF	1.00
34P31	VEHICLE ABATEMENT ENFORCEMENT OFFICER	2.00

Recommended FY 2023-24 Positions

Classification Code	Classification Label	FTE
36A22	DEPUTY SHERIFF-OPERATIONS	91.00
36A23	SHERIFFS SERGEANT	12.00
36A82	SHERIFFS COMMANDER	2.00
80E22	OFFICE ASSISTANT III	1.00
	Total	109.00

Enforcement Operations and Administration

(Budget Unit 8242—Fund 022—Appropriation Unit SHE006)

Use of Funds

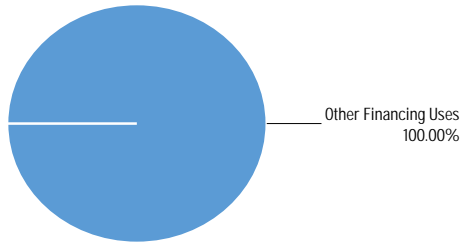

Source of Funds

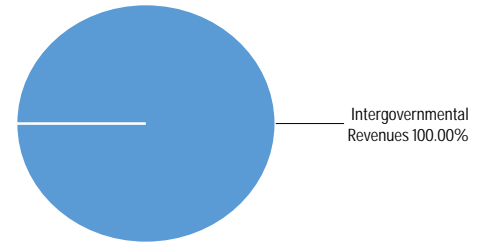

Use of Funds

Expenditures	Prior Year 2021-2022	Adopted Budget 2022-2023	CY Estimate 2022-2023	Requested Budget 2023-2024	Recommended Budget 2023-2024	Recommended Change from Adopted
Other Financing Uses	\$299,571	\$475,000	\$475,000	\$652,300	\$652,300	\$177,300
Subtotal	\$299,571	\$475,000	\$475,000	\$652,300	\$652,300	\$177,300

Source of Funds

Revenues	Prior Year 2021-2022	Adopted Budget 2022-2023	CY Estimate 2022-2023	Requested Budget 2023-2024	Recommended Budget 2023-2024	Recommended Change from Adopted
Intergovernmental Revenues	\$262,915	\$475,000	\$475,000	\$652,300	\$652,300	\$177,300
Subtotal	\$262,915	\$475,000	\$475,000	\$652,300	\$652,300	\$177,300
Fund Balance	\$36,656	—	—	—	—	—
Total Source of Funds	\$299,571	\$475,000	\$475,000	\$652,300	\$652,300	\$177,300

Unit Description

The FY 2011-12 State budget enacted a shift or "realignment" of State program responsibilities and revenues to local governments. To support the various realigned criminal justice, mental health, and social services programs, the Legislature passed Assembly Bill 118 (Chapter 40, Statutes of 2011). AB 118 created the new Local

Revenue Fund 2011, in which a portion of State sales tax and vehicle license fee revenues are deposited, and provided an accounting structure. For transparency in reporting, the County established Fund 022 to account for all public safety realignment revenues related to the Local Revenue Fund. Operating transfers occur between the General Fund and Fund 022 for realigned programs' payments.

Coroner & Investigation

(Budget Unit 8245—Fund 001—Appropriation Unit SHE001)

Use of Funds

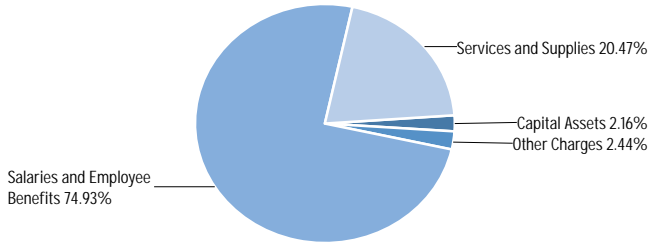

Source of Funds

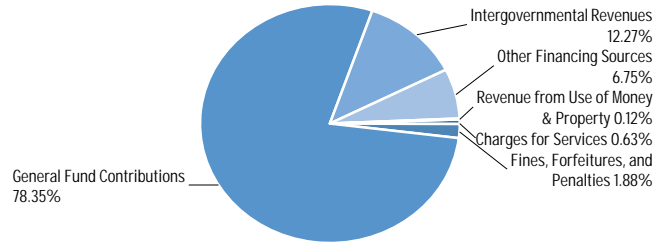

Use of Funds

Expenditures	Prior Year 2021-2022	Adopted Budget 2022-2023	CY Estimate 2022-2023	Requested Budget 2023-2024	Recommended Budget 2023-2024	Recommended Change from Adopted
Salaries and Employee Benefits	\$6,549,295	\$6,713,132	\$7,667,300	\$7,634,573	\$7,634,573	\$921,441
Services and Supplies	\$1,547,295	\$2,192,018	\$1,333,878	\$2,085,856	\$2,085,856	\$(106,162)
Other Charges	\$234,863	\$314,687	\$314,687	\$248,493	\$248,493	\$(66,194)
Capital Assets	\$88,025	\$219,600	\$219,600	\$359,600	\$219,600	—
Subtotal	\$8,419,478	\$9,439,437	\$9,535,465	\$10,328,522	\$10,188,522	\$749,085

Source of Funds

Revenues	Prior Year 2021-2022	Adopted Budget 2022-2023	CY Estimate 2022-2023	Requested Budget 2023-2024	Recommended Budget 2023-2024	Recommended Change from Adopted
Fines, Forfeitures, and Penalties	\$102,249	\$155,000	\$71,108	\$191,308	\$191,308	\$36,308
Revenue from Use of Money & Property	\$13,000	\$12,000	\$12,000	\$12,000	\$12,000	—
Intergovernmental Revenues	\$754,546	\$1,168,000	\$1,142,967	\$1,250,000	\$1,250,000	\$82,000
Charges for Services	\$73,087	\$70,000	\$64,930	\$64,390	\$64,390	\$(5,610)
Miscellaneous Revenues	—	\$400,000	\$11	—	—	\$(400,000)
Other Financing Sources	\$444,045	\$640,000	\$444,045	\$688,073	\$688,073	\$48,073
Subtotal	\$1,386,927	\$2,445,000	\$1,735,061	\$2,205,771	\$2,205,771	\$(239,229)
General Fund Contributions	\$7,032,551	\$6,994,437	\$7,800,404	\$8,122,751	\$7,982,751	\$988,314
Total Source of Funds	\$8,419,478	\$9,439,437	\$9,535,465	\$10,328,522	\$10,188,522	\$749,085

Unit Description

The Coroner's Office investigates all deaths reportable to the Sheriff-Coroner and determines the cause and manner surrounding reportable deaths. There are also contractual obligations with local hospitals to provide forensic pathologist services. The Investigation unit investigates major, complex and sensitive criminal cases that are reported in the unincorporated area and assists other agencies by providing investigative resources when requested. Sub-units focus on person crimes (e.g. homicide, robbery), property crimes, sexual assault and domestic violence. This unit also includes the Agricultural Crimes unit, the Sexual Assault Felony Enforcement (SAFE) Team and Crime Lab.

Recommended FY 2023-24 Positions

Classification Code	Classification Label	FTE
14C31	MANAGEMENT ANALYST III	1.00
34E22	FORENSIC EVIDENCE TECHNICIAN	2.00
34E30	SUPERVISING FORENSIC EVIDENCE TECHNICIAN	1.00
36A22	DEPUTY SHERIFF-OPERATIONS	18.00
36A24	SHERIFFS INVESTIGATIVE SERGEANT	3.00
36A82	SHERIFFS COMMANDER	1.00
50S01	FORENSIC AUTOPSY TECHNICIAN	2.00
80I06	SHERIFFS PROPERTY TECHNICIAN	2.00
Total		30.00

Coroner & Investigation

(Budget Unit 8245—Fund 022—Appropriation Unit SHE006)

Use of Funds

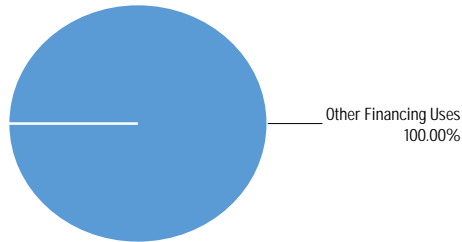

Source of Funds

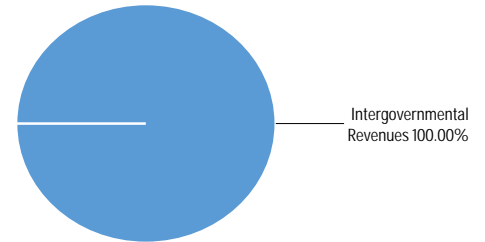

Use of Funds

Expenditures	Prior Year 2021-2022	Adopted Budget 2022-2023	CY Estimate 2022-2023	Requested Budget 2023-2024	Recommended Budget 2023-2024	Recommended Change from Adopted
Other Financing Uses	\$268,645	\$420,000	\$420,000	\$416,280	\$416,280	\$(3,720)
Subtotal	\$268,645	\$420,000	\$420,000	\$416,280	\$416,280	\$(3,720)

Source of Funds

Revenues	Prior Year 2021-2022	Adopted Budget 2022-2023	CY Estimate 2022-2023	Requested Budget 2023-2024	Recommended Budget 2023-2024	Recommended Change from Adopted
Intergovernmental Revenues	\$268,645	\$420,000	\$420,000	\$416,280	\$416,280	\$(3,720)
Subtotal	\$268,645	\$420,000	\$420,000	\$416,280	\$416,280	\$(3,720)
Fund Balance	—	—	—	—	—	—
Total Source of Funds	\$268,645	\$420,000	\$420,000	\$416,280	\$416,280	\$(3,720)

Unit Description

The FY 2011-12 State budget enacted a shift or "realignment" of State program responsibilities and revenues to local governments. To support the various realigned criminal justice, mental health, and social services programs, the Legislature passed Assembly Bill 118 (Chapter 40, Statutes of 2011). AB 118 created the new Local

Revenue Fund 2011, in which a portion of State sales tax and vehicle license fee revenues are deposited, and provided an accounting structure. For transparency in reporting, the County established Fund 022 to account for all public safety realignment revenues related to the Local Revenue Fund. Operating transfers occur between the General Fund and Fund 022 for realigned programs' payments.

Narcotics

(Budget Unit 8246—Fund 022—Appropriation Unit SHE006)

Use of Funds

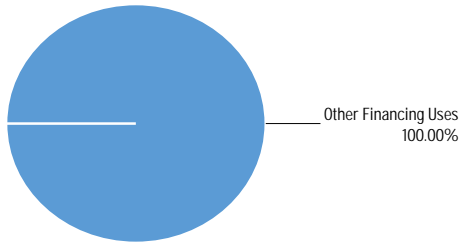

Source of Funds

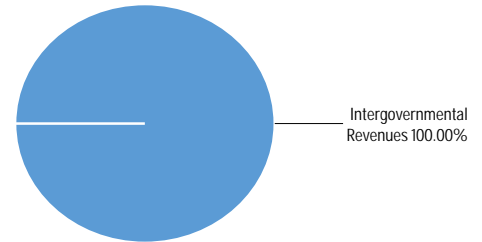

Use of Funds

Expenditures	Prior Year 2021-2022	Adopted Budget 2022-2023	CY Estimate 2022-2023	Requested Budget 2023-2024	Recommended Budget 2023-2024	Recommended Change from Adopted
Other Financing Uses	\$175,400	\$220,000	\$220,000	\$271,793	\$271,793	\$51,793
Subtotal	\$175,400	\$220,000	\$220,000	\$271,793	\$271,793	\$51,793

Source of Funds

Revenues	Prior Year 2021-2022	Adopted Budget 2022-2023	CY Estimate 2022-2023	Requested Budget 2023-2024	Recommended Budget 2023-2024	Recommended Change from Adopted
Intergovernmental Revenues	\$175,400	\$220,000	\$220,000	\$271,793	\$271,793	\$51,793
Subtotal	\$175,400	\$220,000	\$220,000	\$271,793	\$271,793	\$51,793
Fund Balance	—	—	—	—	—	—
Total Source of Funds	\$175,400	\$220,000	\$220,000	\$271,793	\$271,793	\$51,793

Unit Description

The FY 2011-12 State budget enacted a shift or "realignment" of State program responsibilities and revenues to local governments. To support the various realigned criminal justice, mental health, and social services programs, the Legislature passed Assembly Bill 118 (Chapter 40, Statutes of 2011). AB 118 created the new Local

Revenue Fund 2011, in which a portion of State sales tax and vehicle license fee revenues are deposited, and provided an accounting structure. For transparency in reporting, the County established Fund 022 to account for all public safety realignment revenues related to the Local Revenue Fund. Operating transfers occur between the General Fund and Fund 022 for realigned programs' payments.

Community Services and Special Enforcement

(Budget Unit 8250—Fund 001—Appropriation Unit SHE001)

Use of Funds

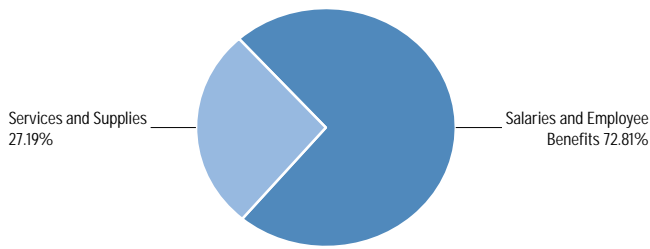

Source of Funds

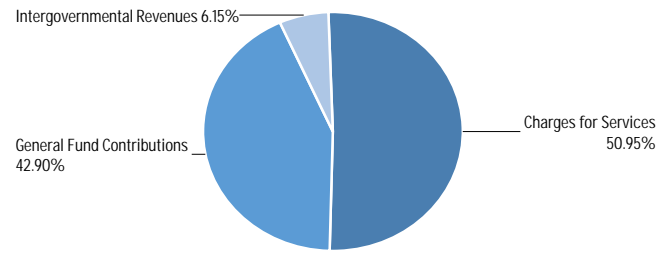

Use of Funds

Expenditures	Prior Year 2021-2022	Adopted Budget 2022-2023	CY Estimate 2022-2023	Requested Budget 2023-2024	Recommended Budget 2023-2024	Recommended Change from Adopted
Salaries and Employee Benefits	\$3,621,422	\$2,132,693	\$2,985,420	\$1,871,120	\$1,871,120	\$(261,573)
Services and Supplies	\$383,793	\$615,825	\$336,143	\$698,680	\$698,680	\$82,855
Other Charges	\$(102,420)	—	—	\$(129,917)	\$(129,917)	\$(129,917)
Subtotal	\$3,902,794	\$2,748,518	\$3,321,563	\$2,439,883	\$2,439,883	\$(308,635)

Source of Funds

Revenues	Prior Year 2021-2022	Adopted Budget 2022-2023	CY Estimate 2022-2023	Requested Budget 2023-2024	Recommended Budget 2023-2024	Recommended Change from Adopted
Licenses, Permits, and Franchises	—	\$9,000	—	—	—	\$(9,000)
Fines, Forfeitures, and Penalties	\$13,569	\$8,500	\$11,682	—	—	\$(8,500)
Intergovernmental Revenues	\$128,711	\$150,000	\$130,000	\$150,000	\$150,000	—
Charges for Services	\$820,716	\$1,163,825	\$1,320,000	\$1,243,142	\$1,243,142	\$79,317
Miscellaneous Revenues	—	—	\$2	—	—	—
Subtotal	\$962,996	\$1,331,325	\$1,461,684	\$1,393,142	\$1,393,142	\$61,817
General Fund Contributions	\$2,939,798	\$1,417,193	\$1,859,879	\$1,046,741	\$1,046,741	\$(370,452)
Total Source of Funds	\$3,902,794	\$2,748,518	\$3,321,563	\$2,439,883	\$2,439,883	\$(308,635)

Unit Description

The Community Services unit manages the many special events that are held each year in Monterey County. These events draw large numbers of spectators and visitors to the area requiring an additional law enforcement presence. The unit also manages the Sheriff's Office fleet of vehicles, all volunteer units (Reserves, Mounted, Aero Squad, Sheriff's Emergency Assistance Team), and other specialized teams, including the Search and Rescue Team (SAR). Pursuant to 26614 of the California Government Code, the Sheriff has the authority to search for and rescue missing persons in the County. Each year, the SAR Team and the Dive Team responds to numerous calls for service regarding vehicles over a cliff, lost or injured hikers, divers or swimmers in distress, or other miscellaneous associated calls for service.

In FY 2016-17, the Sheriff's Office expanded the Sheriff's Emergency Assistance Team (SEAT) and the Explorer Post. The

SEAT volunteer unit provides support personnel to respond to events with traffic control, manning of road blocks, and incident support. SEAT has also begun to provide a cadre of members to conduct Citizens on Patrol activities in the Monterey Peninsula area. This service is being expanded to include Central Station and South County Station coverage. The Explorer Post is an avenue for youth to participate in Sheriff's Office activities while providing limited personnel resources for major events throughout the County.

The Special Enforcement unit responds to many critical or high-risk incidents outside the training, experience and equipment capabilities of patrol deputies, including the Special Weapons and Tactical Team (SWAT)/Hostage Negotiators (HNT), the Mobile Field Force (MFF) which is capable of responding to protests and civil disobedience and the Bomb Squad/Weapons of Mass Destruction Team. Additionally, this unit manages the Terrorism Liaison Officers who collaborate with the Northern California Regional Intelligence Center (NCRIC), the Crime Analysts who conduct analysis of crime trends, and the acquisition, training and daily operations of the Canine unit.

Recommended FY 2023-24 Positions

Classification Code	Classification Label	FTE
14H33	CRIMINAL INTELLIGENCE SPECIALIST	1.00
36A22	DEPUTY SHERIFF-OPERATIONS	1.00
36A23	SHERIFFS SERGEANT	1.00
36A82	SHERIFFS COMMANDER	2.00
60S21	CRIME PREVENTION SPECIALIST	1.00
72C25	VEHICLE MAINTENANCE COORDINATOR	1.00
	Total	7.00

Administration and Indirect Costs

(Budget Unit 8273—Fund 001—Appropriation Unit SHE001)

Use of Funds

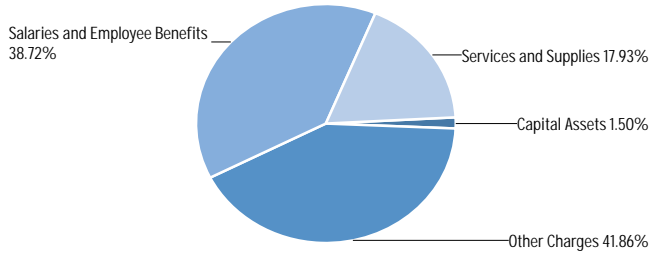

Source of Funds

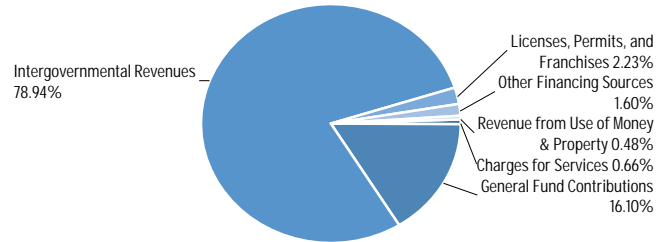

Use of Funds

Expenditures	Prior Year 2021-2022	Adopted Budget 2022-2023	CY Estimate 2022-2023	Requested Budget 2023-2024	Recommended Budget 2023-2024	Recommended Change from Adopted
Salaries and Employee Benefits	\$3,435,240	\$3,977,760	\$4,015,764	\$4,839,040	\$4,429,188	\$451,428
Services and Supplies	\$2,990,283	\$1,382,632	\$1,606,013	\$2,050,889	\$2,050,889	\$668,257
Other Charges	\$3,593,312	\$4,006,957	\$3,798,310	\$4,788,703	\$4,788,703	\$781,746
Capital Assets	\$39,268	\$162,600	\$462,600	\$371,600	\$171,600	\$9,000
Subtotal	\$10,058,104	\$9,529,949	\$9,882,687	\$12,050,232	\$11,440,380	\$1,910,431

Source of Funds

Revenues	Prior Year 2021-2022	Adopted Budget 2022-2023	CY Estimate 2022-2023	Requested Budget 2023-2024	Recommended Budget 2023-2024	Recommended Change from Adopted
Licenses, Permits, and Franchises	\$210,564	\$231,549	\$220,000	\$254,700	\$254,700	\$23,151
Fines, Forfeitures, and Penalties	\$8,026	\$15,000	\$5,269	\$6,000	\$6,000	\$(9,000)
Revenue from Use of Money & Property	\$41,250	\$55,000	\$55,000	\$55,000	\$55,000	—
Intergovernmental Revenues	\$8,763,345	\$7,993,418	\$8,847,360	\$9,024,123	\$9,024,123	\$1,030,705
Charges for Services	\$88,576	\$60,000	\$82,643	\$75,000	\$75,000	\$15,000
Miscellaneous Revenues	\$30,158	\$10,000	\$11,814	\$2,250	\$2,250	\$(7,750)
Other Financing Sources	\$151,014	\$181,435	\$156,435	\$182,650	\$182,650	\$1,215
Subtotal	\$9,292,932	\$8,546,402	\$9,378,521	\$9,599,723	\$9,599,723	\$1,053,321
General Fund Contributions	\$765,172	\$983,547	\$504,166	\$2,450,509	\$1,840,657	\$857,110
Total Source of Funds	\$10,058,104	\$9,529,949	\$9,882,687	\$12,050,232	\$11,440,380	\$1,910,431

Unit Description

The Sheriff’s Office Administration serves as the executive management team that directs the entire organization’s activities to achieve its mission of protecting the lives and property of citizens in Monterey County and operating the County jail. This unit also includes fiscal and Information Technology (IT) services, including department-wide budgeting, accounting and fiscal oversight, payroll services and management information systems support.

Recommended FY 2023-24 Positions

Classification Code	Classification Label	FTE
10B05	SHERIFF	1.00
12A10	CHIEF DEPUTY SHERIFF	1.00
12A13	UNDERSHERIFF	1.00
14B01	PERSONNEL ANALYST	1.00
14C31	MANAGEMENT ANALYST III	1.00
16F41	DEPARTMENTAL INFORMATION SYSTEMS MANAGER II	1.00

Recommended FY 2023-24 Positions

Classification Code	Classification Label	FTE
20B11	ACCOUNTANT II	1.00
20B12	ACCOUNTANT III	1.00
20B93	FINANCE MANAGER II	1.00
43G05	DIGITAL FORENSIC INVESTIGATOR	1.00
43J09	SENIOR DEPARTMENTAL INFORMATION SYSTEMS COORDINATOR	3.00
43J15	SUPERVISING DEPARTMENTAL INFORMATION SYSTEMS COORDINATOR	1.00
80A34	SENIOR SECRETARY-CONFIDENTIAL	1.00
80A99	ADMINISTRATIVE SECRETARY- CONFIDENTIAL	1.00
80J20	ACCOUNTING CLERICAL SUPERVISOR	1.00
80J22	SENIOR ACCOUNT CLERK	3.00
80J30	ACCOUNTING TECHNICIAN	3.00
	Total	23.00

Inmate Medical Program

(Budget Unit 8532—Fund 001—Appropriation Unit SHE003)

Use of Funds

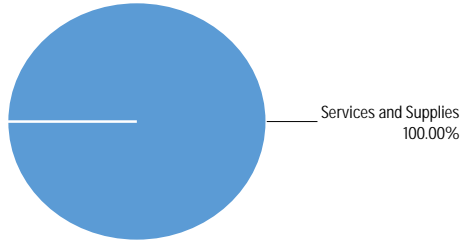

Source of Funds

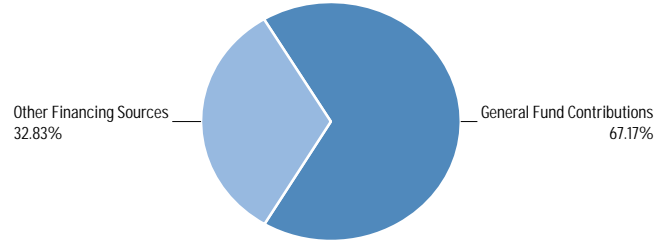

Use of Funds

Expenditures	Prior Year 2021-2022	Adopted Budget 2022-2023	CY Estimate 2022-2023	Requested Budget 2023-2024	Recommended Budget 2023-2024	Recommended Change from Adopted
Services and Supplies	\$10,394,682	\$10,714,509	\$12,317,279	\$15,201,452	\$15,201,452	\$4,486,943
Subtotal	\$10,394,682	\$10,714,509	\$12,317,279	\$15,201,452	\$15,201,452	\$4,486,943

Source of Funds

Revenues	Prior Year 2021-2022	Adopted Budget 2022-2023	CY Estimate 2022-2023	Requested Budget 2023-2024	Recommended Budget 2023-2024	Recommended Change from Adopted
Miscellaneous Revenues	\$34,662	—	—	—	—	—
Other Financing Sources	\$4,174,868	\$4,267,538	\$4,267,538	\$4,990,823	\$4,990,823	\$723,285
Subtotal	\$4,209,530	\$4,267,538	\$4,267,538	\$4,990,823	\$4,990,823	\$723,285
General Fund Contributions	\$6,185,152	\$6,446,971	\$8,049,741	\$10,210,629	\$10,210,629	\$3,763,658
Total Source of Funds	\$10,394,682	\$10,714,509	\$12,317,279	\$15,201,452	\$15,201,452	\$4,486,943

Unit Description

This program monitors and oversees the inmate medical services provider. The County contracts to provide inmate medical, dental, and psychological services.



This page intentionally left blank.

Probation

Departmental Overview:

The Probation Department is an integral part of Monterey County’s criminal justice system and protects citizens of Monterey County by preventing and reducing the frequency, severity, and impact of criminal and delinquent behavior among adults and juveniles. This is accomplished through prevention activities, preparation of appropriate reports, recommendations to the court, enforcement of court orders, assisting victims, and developing new methodologies in probation services. The department is responsible to the Superior Court for overall policy and procedural matters, and to the Board of Supervisors for funding and levels of services.

Programs and Functions:

The department manages the operation of all adult and juvenile probation services, including two 24-hour juvenile institutions, and programs that provide alternatives to detention or are designed to deter juveniles from entering the criminal justice system. Probation is composed of Administration and four operational divisions: Adult, Juvenile, Juvenile Hall and Youth Center. The Adult Division provides support to the Courts, supervises offenders under its jurisdiction, and manages alternative to detention programs. The Juvenile Division provides similar services to Court involved and at-risk youth and their families. The two juvenile institutions, Juvenile Hall and Youth Center, provide safe custodial environments for adjudicated youth, as well as in-custody and reentry rehabilitative services. The Probation Department invests in an array of partnerships and collaborations with County agencies, law enforcement and criminal justice partners, educational institutions and service providers.

Department’s Contribution to Monterey County’s Strategic Initiatives:

ADMINISTRATION, HEALTH AND HUMAN SERVICES, INFRASTRUCTURE

The Administrative Division manages departmental infrastructure and support services: fiscal, including collection of victim restitution, personnel, safety, facilities, fleet, training and technology. The department also manages referrals to services for adult and juvenile clients, serving at-risk youth, utilizing the therapeutic court model, and working with families to improve the home environment. In addition, the department provides leadership in data sharing projects with the courts and other criminal justice partners, as well as County agencies and service providers.

PUBLIC SAFETY

The department uses evidence-based practices in correctional supervision of adult and juvenile offenders, campus-based safety and community supervision through participation in therapeutic courts and alternatives to detention, reentry services, and referral to services addressing criminogenic needs and providing support to client rehabilitation. Clients are assessed for risk and needs and supervised in accordance with court orders by Probation Officers, who provide referrals to community-based services and utilize supervision strategies with the goal of reducing risk factors and supporting positive behavioral changes. The department also fosters collaboration with all criminal justice partners, local law enforcement agencies and service providers.



Probation

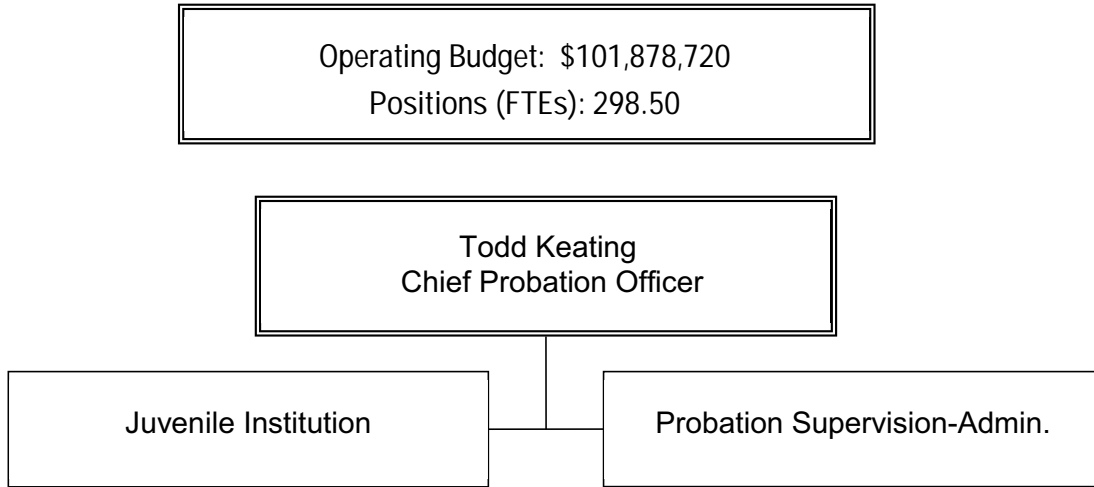

Staffing Trends

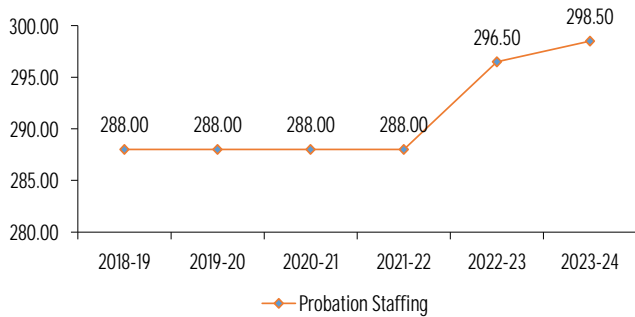

Expenditure/Revenue History (in millions)

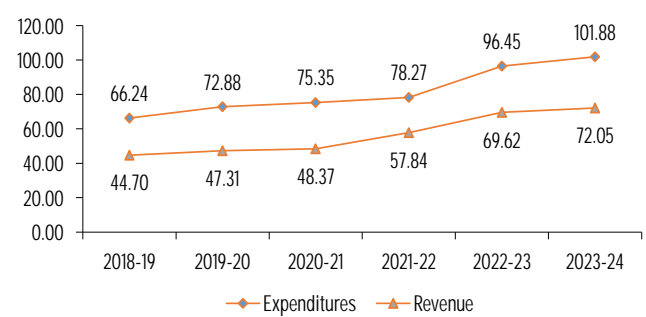

Probationers are assessed and supervised by Probation Officers who monitor compliance with court orders, provide referrals to community based services, and utilize supervision strategies with the goal of reducing risk factors and supporting positive behavioral changes.

Key Performance Measures	2020-21 Actual	2021-22 Actual	2022-23 Mid-Year
Percent of adults who successfully complete probation. Target = 60%	60%	50%	52%
Percent of juveniles who successfully complete probation. Target = 65%	77%	80%	69%
Percent of employees who received an annual employee performance review (EPR). Target = 85%	81%	81%	71%

Use of Funds

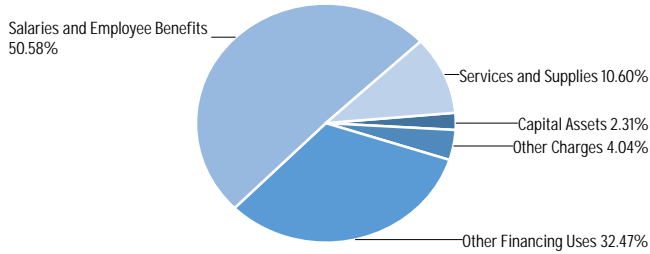

Source of Funds

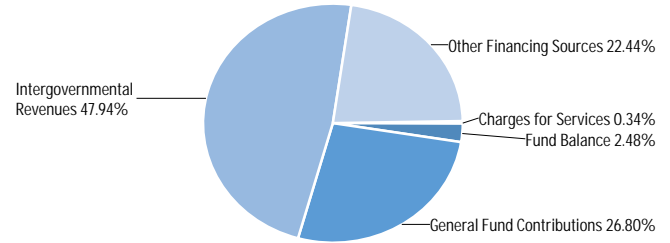

Use of Funds

Expenditures	Prior Year 2021-2022	Adopted Budget 2022-2023	CY Estimate 2022-2023	Requested Budget 2023-2024	Recommended Budget 2023-2024	Recommended Change from Adopted
Salaries and Employee Benefits	\$42,897,392	\$50,850,935	\$50,875,732	\$51,629,599	\$51,527,495	\$676,560
Services and Supplies	\$7,219,651	\$8,928,668	\$8,898,235	\$10,795,779	\$10,795,779	\$1,867,111
Other Charges	\$4,000,162	\$4,359,718	\$4,359,718	\$4,118,516	\$4,118,516	\$(241,202)
Capital Assets	\$295,042	—	—	\$2,354,926	\$2,354,926	\$2,354,926
Other Financing Uses	\$23,861,288	\$32,248,507	\$32,318,425	\$33,082,004	\$33,082,004	\$833,497
Subtotal	\$78,273,535	\$96,387,828	\$96,452,110	\$101,980,824	\$101,878,720	\$5,490,892

Source of Funds

Revenues	Prior Year 2021-2022	Adopted Budget 2022-2023	CY Estimate 2022-2023	Requested Budget 2023-2024	Recommended Budget 2023-2024	Recommended Change from Adopted
Fines, Forfeitures, and Penalties	\$1,918	\$6,572	\$6,572	\$6,572	\$6,572	—
Intergovernmental Revenues	\$40,958,984	\$43,234,120	\$46,048,525	\$48,831,606	\$48,831,606	\$5,597,486
Charges for Services	\$292,243	\$347,631	\$347,631	\$347,631	\$347,631	—
Miscellaneous Revenues	\$16,240	\$9,996	\$9,996	\$9,996	\$9,996	—
Other Financing Sources	\$16,569,900	\$23,206,043	\$23,206,043	\$22,855,868	\$22,855,868	\$(350,175)
Subtotal	\$57,839,285	\$66,804,362	\$69,618,767	\$72,051,673	\$72,051,673	\$5,247,311
Fund Balance	\$(4,706,609)	\$2,620,005	\$(124,482)	\$2,527,790	\$2,527,790	\$(92,215)
General Fund Contributions	\$25,140,859	\$26,963,461	\$26,957,825	\$27,401,361	\$27,299,257	\$335,796
Total Source of Funds	\$78,273,535	\$96,387,828	\$96,452,110	\$101,980,824	\$101,878,720	\$5,490,892

Summary of Recommendation

The FY 2023-24 Recommended Budget for Probation is \$101,878,720, a net increase of \$5,490,892. The Recommended Budget is financed by \$72,051,673 in program revenue, \$27,299,257 in General Fund Contribution (GFC) and \$2,527,790 in one-time departmental restricted fund balance.

Appropriations and revenue levels are respectively \$5,490,892 and \$5,247,311 higher than the FY 2022-23 Adopted Budget. The increase in appropriations is primarily due to higher salary and benefit costs and pension contributions (\$676,560); increases in operational transfers from the Local Revenue Fund to reimburse the General Fund (\$833,497); State funded facility improvements (\$1.3 million); and an increase in services for the State funded SB 823 Department of Juvenile Justice (DJJ) Realignment program (\$2.0 million).

The Department expects an increase of \$5.2 million in revenue and reimbursements. The increase of \$4.2 million in revenue is chiefly funded by the State for the SB 823 DJJ Realignment program (\$2.0

million), AB 178 related grants (\$1.5 million) for Juvenile Facilities and Youth Transitional Housing, and Public Safety Sales Tax (\$318,906). The increase of \$1.0 million in reimbursements is primarily funded by monies from the AB 109 Public Safety Realignment and Juvenile Probation Camp funding. The Department's GFC increased by \$335,796.

The Recommended Budget includes two (2) augmentations (\$276,385) adding new positions fully funded by SB 823 DJJ Realignment: a Deputy Probation Officer II and a Probation Aide. The Recommended Budget also includes an augmentation of \$136,182 for Juvenile Hall building systems maintenance. During the course of the fiscal year, the department also reallocated a Laundry Worker to a Building Maintenance Worker to accommodate the additional workload. Finally, a Word Processor position was reclassified to an Office Assistant III to better match the duties being fulfilled.

The Recommended Budget of \$101,878,720 continues to reflect two fund sources: the Local Revenue Fund budget of \$33,082,004 and a

General Fund budget of \$68,796,716. Pursuant to State legislation, the Local Revenue Fund is a pass-through fund primarily for receipt of AB 109 Public Safety Realignment monies. The Department's AB 109 positions and operations are paid from the General Fund and reimbursed from the Local Revenue Fund as expenses are incurred. The funding associated with these realigned responsibilities is shared with other justice partners, including the Sheriff, District Attorney, Public Defender, and Health in the form of operating transfers from Probation to the recipient departments.

The Recommended Budget includes 298.5 full time equivalent positions.

Budget Impacts

The Recommended Budget maintains service levels at status quo operations and provides increased services to the State funded program for the DJJ realignment, but continued constrained resources challenge the department's ongoing ability to maintain this position. County revenues are not generating the growth needed to sustain significantly increasing costs. The department continues to experience significant increases in non-discretionary costs related to employee compensation, pensions and County infrastructure. In response to this funding constraint, Probation's Recommended Budget includes use of departmental restricted fund balance that is one-time in nature, for continuing mandated services. Additionally, the future program expansion for mandated services for the SB 129 Pretrial program in the form of necessary additional staff will impact service delivery as ongoing State funding is projected to fall short of the needed amount. Further, the Recommended Budget does not include the department's requested augmentation of \$102,104 to meet obligations related to leave accrual buybacks. The department will continue to closely monitor expenses, and, as necessary, request additional appropriations.

Prior Year Accomplishments

With the development of a Secure Youth Treatment Facility within the confines of Juvenile Hall following the passage of SB 823, institutional programming has expanded to meet the needs of the realigned population, including curriculum from Homeboy Art Academy, Success Stories Program, Wonder Wood Ranch, and enhanced therapeutic curriculum facilitated by Children's Behavioral Health.

To meet the legislative mandates and rehabilitative needs of the realigned population, a formal individualized rehabilitation and re-entry case plan template was created to be used by staff, as well as the formation of an Intradisciplinary Team of representatives from collaborative agencies within the Secure Youth Treatment Program to address and coordinate rehabilitative goals for the realigned population. To assist with reintegration and continuity of services, a community furlough program for youth was created with court approval for a less-restrictive re-entry program setting. This program will enable youth to attend services, education, prosocial activities, and employment within the community; returning to the detention facility after their approved schedule of activities to continue treatment and services within the Secure Youth Treatment Program.

The Monterey County Youth Center continues to provide and consistently review and identify new programming/services that are evidence-based, focused on their needs and other factors that may arise during their Youth Center Program/Aftercare. Youth Center program offerings include Strengthening Families, Life Skills through Sun Street Center, Wonder Wood Ranch equine therapy, Cooking

Fundamentals Class/Serv Safe certification, behavioral health access, Hartnell College Class Ethnic Studies and Power Through Choices.

The Youth Center staff began working with the youth on completing a resume, submitting job applications, applying for financial aid, enrolling in college and securing housing and or enrolling in a high school program prior to them returning home on Aftercare. Once on Aftercare, they can begin to work, obtain a bank account, apply for their ID and/or Driver's License and/or work with programs that offer transitional living for those youth that have reached 18 or older. Additional paid work experience for youth with a diploma or GED is available through the Workforce Development Program and the Monterey County Office of Education Goodwill program.

Hartnell College has expanded services to the facility for post-secondary education classes and the Prison Education Program now provides supplemental education and tutoring services for graduates within the facility, concentrating on educational skills and practice to enhance their pathway to success in college-level courses. The program utilizes volunteer students from the California State University and the University of California, many of whom are formally system impacted students. Children's Behavioral Health has added a full-time psychiatric social worker to the Secure Youth Treatment Program to facilitate moral reconnection therapy, individualized and family therapy, and cognitive behavior treatment with the population. Additionally, as part of the department review of policy and protocols following the passage of SB 823, Juvenile Hall integrated the results of the Youth Assessment Screening Instrument (YASI) risk tool into the case plans for youthful offenders, to provide targeted rehabilitation interventions for each offender and supervision in the community based upon risk of recidivism. When violations occur, officers are trained to utilize the least restrictive sanction to achieve the desired result, with the goal of keeping offenders in the community to receive services unless they represent a clear threat to themselves or others.

Pretrial services continue to make progress toward full implementation and it is estimated the program is approximately 85% toward achieving that goal. The courts are provided with a comprehensive assessment report that addresses the likelihood of a client returning to court and offers conditions of monitoring that correspond with the clients' risk score. The courts then decide the appropriateness of releasing the client on pretrial services. However, the recent request by the courts to expand services to conducting assessments on misdemeanor offenses poses a capacity challenge and ultimately will require additional staff in order to meet SB129 compliance.

The department contracted with Jay Aguas & Associates to provide Motivational Interviewing (MI) training for staff, which in some cases was an introduction to these techniques to new staff and more of a refresher course for veteran staff. This course reinvigorated the department's commitment to evidence-based practices in order to provide staff with the tools to assist clients address their criminogenic needs and risks and guide them toward becoming more productive community members.

Working closely with the Monterey County Superior Court and Children's Behavioral Health, the Juvenile Division updated the workflow processes for staff, and created new court report templates to comply with and implement the new Families First Prevention Service Act (FFPSA) legislation in accordance with State timelines.

The department completed contract negotiations with Tyler Technologies and entered into agreement for the procurement of a

new Probation Case Management System (CMS). This project is in progress and currently in the data conversion phase to be followed by training and implementation to be completed by the end of calendar year 2023.

Budget Year Goals

Identify opportunities to install signage to clearly identify the 20 East Alisal Street building as the Monterey County Probation Department.

Implement a resource family recruitment for foster care placements specific to Probation.

Contract with a recognized provider for updated training and coaching on best practices in Community Supervision for juvenile and adult Probation staff.

As appropriate, increase the use of offender reporting via OffenderLink to automate or supplement the supervision of clients meeting the established criteria.

Create new statistical reports for youth in custody to: a) support monthly and annual reporting requirements and b) to utilize data and statistical information to support informed decision making.

Redesign the Probation Department website and implement a process for updating and maintaining content.

Develop a proof of concept for Probation to upgrade and migrate to the County's new version of Share Point; currently Probation is utilizing an older version of Share Point.

Increase technical knowledge to support the Tyler Case Management System, as well as achieve sufficient training levels for Probation IT staff to accurately and timely report and query the data in the Tyler CMS.

Complete Probation data exchange from SRN to SRQ file format with the Department of Justice with a go live date no later than July 2023.

Pending Issues

The Continuum of Care Reform (CCR) shortened the length of stay in out-of-home placement for some juvenile wards of the Court. Consequently, Probation will be involved in activities to facilitate and expedite the child's return to the family or family-type setting with the use of resource families, while reducing the use of congregate (group home) care. CCR has greatly impacted Probation with additional responsibilities, and its placement process and use of various levels of foster care for juvenile justice youth. Another challenge is the lack of licensed Short Term Residential Therapeutic Program (STRTP) facilities in Monterey County to serve this youth population. Additionally, effective October 1, 2021, pursuant to the Families First Prevention Services Act (FFPSA), any youth placed into a STRTP facility requires an assessment from a designated Qualified Individual (QI) and additional responsibilities and oversight by the Court, Probation and the Interagency Placement Committee. This could potentially have a negative impact as the STRTP would not be eligible for certain funding if the QI assessment determines STRTP placement is not appropriate.

Since the implementation of AB 12-Extended Foster Care in 2012, eligible non-minor dependents can opt to remain in "foster care" under Probation's case management from the age of 18 to 21. In this scenario, the Probation Officer assumes a case manager role, and is

mandated by Placement rules (once a month visitations face-to-face, etc.), irrespective of where the minor resides. Since 2012, Probation has case-managed about 69 youths in Idaho, Oregon, Texas, Arizona, and California (the department currently has 8 in the caseload, all in California). Although there is revenue for the program through time study activities and capped reimbursement, the activities can be intense and time consuming for the officers traveling long distance and out of State.

The new Juvenile Hall capital project was completed and the residents relocated to the new facility. However, the project was scaled down due to funding constraints, and essential areas such as space for programming, kitchen, dining, and laundry areas were eliminated. This continues to limit Probation's ability to provide services to the residents and is further aggravated by the realignment of youth from State juvenile facilities to Probation's custodial responsibility.

Budget Trailer Bill SB 823, effective July 1, 2021, transferred responsibility for managing youthful offenders under State custody to local jurisdictions and initiated the closure of California's State Division of Juvenile Justice (DJJ) and its juvenile correctional facilities. The realigned population include youth under juvenile court jurisdiction that in the past would have been committed to custody in one of the State's juvenile correctional facilities due to the severity of their crimes. The short implementation timeline outlined by the legislation, its impact upon the Department's infrastructure needs, the creation of specialized programs and behavior management protocols for long-term commitments, and development of comprehensive medical and mental health services for long-term commitments continue to be a considerable challenge for all California counties. Further, the implementation of the responsibility shift for long-term housing, care, and meaningful rehabilitation guidelines that were outlined in the original legislation and the clarifying SB 92 legislation, has resulted in a need for ongoing collaborative development of services to address crucial components of the legislation, as well as those that remain unanswered. These items include additional clarifying legislation to address outstanding legal issues; provide direction for uniformity in operational application of the legislation throughout the State of California; provided additional guidance on sentencing procedures and discharge guidelines for the new secure youth facility sentencing track; development of specialized placements, programs, and services that meet the benchmarks outlined by the legislature, and develop the necessary critical updates to the County's local infrastructure needed to accommodate youth placed in long-term detention by the court.

The absence of a locked mental health residential treatment facility for youth with severe mental illnesses is an additional challenge for the realigned population. Although there are efforts to identify funding and all needed resources, this remains a slow process and a significant unmet need.

In March 2021, the California Supreme Court upheld a First Appellate District decision (in re Humphrey) indicating that the money bail system violated due process and equal protection by imprisoning defendants prior to trial solely because they could not afford to pay bail. While the ruling does not ban cash bail, it impels the judiciary to favor pretrial release and consider a person's ability to pay before setting bail, thus greatly reducing or eliminating the cash payment for some offenders. Possible impacts to Probation, as the current provider of limited pretrial services to the courts are unknown at this time.

Under Senate Bill 129, the 2021-22 California state budget appropriated \$140 million (\$70 million ongoing) to the Judicial

Council to fund the implementation and operation of ongoing court programs and practices that promote safe, efficient, fair and timely pretrial programs. The funding is intended to provide courts with information and resources to support judicial officers in making pretrial release decisions that impose the least restrictive conditions to address public safety and return to court as well as implementation of appropriate monitoring practices and provision of services for released individuals. Monterey County Superior Court is contracting with Probation to expand current limited pretrial services. It is anticipated that the lack of appropriate candidates to fill vacant SB129 Probation Department positions will negatively impact the staffing needed for full and timely implementation. This could result in overly

burdening current staff and hinder monitoring services. Additionally, securing appropriate training for staff on the selected assessment tool and ensuring that comprehensive systems are created with collaborative partners presents challenges to meet established milestones. Although initial funding provided from the courts is sufficient for the first year of the program, funding for subsequent years is anticipated to fall short of the amount needed to sustain the mandated services and necessary staff.

Policy Considerations

There are no policy considerations.

Appropriation Expenditure Detail

	Prior Year 2021-2022	Adopted Budget 2022-2023	CY Estimate 2022-2023	Requested Budget 2023-2024	Recommended Budget 2023-2024	Recommended Change from Adopted	Fund Code	Budget Unit Code
Alternative Programs (PRO001)	3,020,811	3,694,037	3,698,437	3,738,002	3,738,002	43,965	001	8162
Alternative Programs (PRO002)	4,074,184	2,185,708	2,185,708	2,184,312	2,184,312	(1,396)	022	8162
Juvenile Hall (PRO001)	10,426,306	13,742,103	13,742,103	16,902,249	16,902,249	3,160,146	001	8163
Youth Center (PRO001)	9,457,034	10,824,259	10,794,334	11,434,195	11,434,195	609,936	001	8164
Youth Center (PRO002)	3,968,646	9,566,355	9,647,519	8,822,176	8,822,176	(744,179)	022	8164
Adult Probation (PRO001)	17,388,417	20,367,114	20,369,669	21,202,806	21,202,806	835,692	001	8165
Adult Probation (PRO002)	15,209,681	20,108,409	20,108,409	21,687,481	21,687,481	1,579,072	022	8165
Juvenile Probation (PRO001)	7,365,894	8,497,585	8,499,523	8,717,039	8,717,039	219,454	001	8166
Juvenile Probation (PRO002)	608,777	388,035	376,789	388,035	388,035	0	022	8166
Probation Administration (PRO001)	6,753,785	7,014,223	7,029,619	6,904,529	6,802,425	(211,798)	001	8167
Subtotal	\$78,273,535	\$96,387,828	\$96,452,110	\$101,980,824	\$101,878,720	\$5,490,892		

Budget Units

	Prior Year 2021-2022	Adopted Budget 2022-2023	CY Estimate 2022-2023	Requested Budget 2023-2024	Recommended Budget 2023-2024	Recommended Change from Adopted
Alternative Programs	\$7,094,994	\$5,879,745	\$5,884,145	\$5,922,314	\$5,922,314	\$42,569
Juvenile Hall	\$10,426,306	\$13,742,103	\$13,742,103	\$16,902,249	\$16,902,249	\$3,160,146
Youth Center	\$13,425,680	\$20,390,614	\$20,441,853	\$20,256,371	\$20,256,371	\$(134,243)
Adult Probation	\$32,598,098	\$40,475,523	\$40,478,078	\$42,890,287	\$42,890,287	\$2,414,764
Juvenile Probation	\$7,974,671	\$8,885,620	\$8,876,312	\$9,105,074	\$9,105,074	\$219,454
Probation Administration	\$6,753,785	\$7,014,223	\$7,029,619	\$6,904,529	\$6,802,425	\$(211,798)
Subtotal	\$78,273,535	\$96,387,828	\$96,452,110	\$101,980,824	\$101,878,720	\$5,490,892

Adopted FY 2022-23 to Recommended FY 2023-24 Positions

Classification Code	Classification Label	Adopted Budget 2021-2022	Adopted Budget 2022-2023	Recommended Budget 2023-2024	Change
11A06	CHIEF PROBATION OFFICER	1.00	1.00	1.00	0.00
12C35	ASSISTANT CHIEF PROBATION OFFICER	1.00	1.00	1.00	0.00
14B32	SENIOR PERSONNEL ANALYST	0.00	1.00	1.00	0.00
14C30	MANAGEMENT ANALYST II	4.00	3.00	3.00	0.00
14C31	MANAGEMENT ANALYST III	2.00	2.00	2.00	0.00
14H03	PERSONNEL TECHNICIAN-CONFIDENTIAL	1.00	1.00	1.00	0.00
16C87	BUSINESS TECHNOLOGY ANALYST II	2.00	2.00	2.00	0.00
16F41	DEPARTMENTAL INFORMATION SYSTEMS MANAGER II	1.00	1.00	1.00	0.00
20B10	ACCOUNTANT I	2.00	2.00	2.00	0.00

Adopted FY 2022-23 to Recommended FY 2023-24 Positions

Classification Code	Classification Label	Adopted Budget 2021-2022	Adopted Budget 2022-2023	Recommended Budget 2023-2024	Change
20B11	ACCOUNTANT II	1.00	1.00	1.00	0.00
20B12	ACCOUNTANT III	1.00	1.00	1.00	0.00
20B93	FINANCE MANAGER II	1.00	1.00	1.00	0.00
43J09	SENIOR DEPARTMENTAL INFORMATION SYSTEMS COORDINATOR	1.00	1.00	1.00	0.00
60F02	PROBATION AIDE	15.50	18.50	19.50	1.00
60F22	DEPUTY PROBATION OFFICER II	72.00	73.00	74.00	1.00
60F23	DEPUTY PROBATION OFFICER III	24.00	25.00	25.00	0.00
60F84	PROBATION SERVICES MANAGER	14.00	14.00	14.00	0.00
60F85	PROBATION DIVISION MANAGER	4.00	4.00	4.00	0.00
60F87	JUVENILE INSTITUTIONS SUPERVISOR	9.00	9.00	9.00	0.00
60F89	JUVENILE INSTITUTIONS OFFICER II	73.00	73.00	73.00	0.00
60F90	SENIOR JUVENILE INSTITUTIONS OFFICER	13.00	13.00	13.00	0.00
60I02	PROGRAM MANAGER II	1.00	1.00	1.00	0.00
60K02	VICTIM ASSISTANCE ADVOCATE	2.00	2.00	2.00	0.00
70K23	COOK	0.00	5.00	5.00	0.00
70K25	SENIOR COOK	4.50	1.00	1.00	0.00
70K80	HEAD COOK	1.00	1.00	1.00	0.00
70K83	FOOD ADMINISTRATOR-PROBATION	1.00	1.00	1.00	0.00
70L01	LAUNDRY WORKER I	1.00	1.00	0.00	(1.00)
72A23	BUILDING MAINTENANCE WORKER	0.00	0.00	1.00	1.00
72A29	SENIOR BUILDING MAINTENANCE WORKER	1.00	1.00	1.00	0.00
80A30	SECRETARIAL ASSISTANT	1.00	1.00	1.00	0.00
80A32	SENIOR SECRETARY	1.00	1.00	1.00	0.00
80A99	ADMINISTRATIVE SECRETARY-CONFIDENTIAL	1.00	1.00	1.00	0.00
80E21	OFFICE ASSISTANT II	14.00	16.00	16.00	0.00
80E22	OFFICE ASSISTANT III	7.00	7.00	8.00	1.00
80E82	SUPERVISING OFFICE ASSISTANT II	2.00	2.00	2.00	0.00
80J22	SENIOR ACCOUNT CLERK	1.00	1.00	1.00	0.00
80J30	ACCOUNTING TECHNICIAN	4.00	4.00	4.00	0.00
80W21	WORD PROCESSOR	3.00	3.00	2.00	(1.00)
Total		288.00	296.50	298.50	2.00

Augmentation Requests

Request Code	Request Name	Ranking Type Name	Requested Amount	Requested FTE	Recommended Budget	Recommended FTE
2550-8163-001-AUG1	SB823 New Deputy Probation Officer II	New Mandated Program/ Service w/ Outside Funding	-	1.00	-	1.00
2550-8163-001-AUG2	SB823 New Probation Aide	New Mandated Program/ Service w/ Outside Funding	-	1.00	-	1.00
2550-8163-001-AUG3	Juvenile Hall Building Systems Maintenance	Status Quo Other	136,182	-	136,182	-
2550-8167-001-AUG4	Leave Buyback Unit M, N, L, F, J, X & Y	Status Quo Other	102,104	-	-	-
Grand Total:			\$238,286	2.00	\$136,182	2.00

Probation

Alternative Programs

(Budget Unit 8162—Fund 001—Appropriation Unit PRO001)

Use of Funds

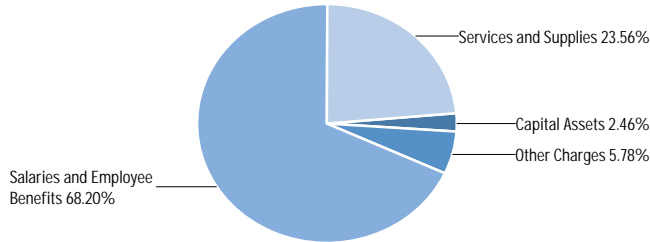

Source of Funds

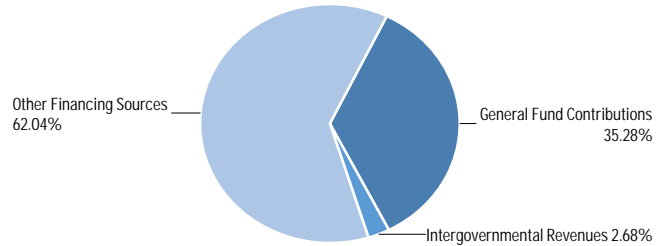

Use of Funds

Expenditures	Prior Year 2021-2022	Adopted Budget 2022-2023	CY Estimate 2022-2023	Requested Budget 2023-2024	Recommended Budget 2023-2024	Recommended Change from Adopted
Salaries and Employee Benefits	\$1,961,854	\$2,513,829	\$2,513,829	\$2,549,273	\$2,549,273	\$35,444
Services and Supplies	\$710,393	\$937,608	\$942,008	\$880,759	\$880,759	\$(56,849)
Other Charges	\$256,743	\$242,600	\$242,600	\$216,150	\$216,150	\$(26,450)
Capital Assets	\$91,821	—	—	\$91,820	\$91,820	\$91,820
Subtotal	\$3,020,811	\$3,694,037	\$3,698,437	\$3,738,002	\$3,738,002	\$43,965

Source of Funds

Revenues	Prior Year 2021-2022	Adopted Budget 2022-2023	CY Estimate 2022-2023	Requested Budget 2023-2024	Recommended Budget 2023-2024	Recommended Change from Adopted
Intergovernmental Revenues	\$208,417	\$100,000	\$100,000	\$100,000	\$100,000	—
Charges for Services	\$6,870	—	—	—	—	—
Other Financing Sources	\$1,612,975	\$2,263,469	\$2,263,469	\$2,319,054	\$2,319,054	\$55,585
Subtotal	\$1,828,262	\$2,363,469	\$2,363,469	\$2,419,054	\$2,419,054	\$55,585
General Fund Contributions	\$1,192,549	\$1,330,568	\$1,334,968	\$1,318,948	\$1,318,948	\$(11,620)
Total Source of Funds	\$3,020,811	\$3,694,037	\$3,698,437	\$3,738,002	\$3,738,002	\$43,965

Unit Description

The Alternative Programs unit manages a variety of programs directed at adjudicated and at-risk youth. These programs include the Silver Star Youth Program at Rancho Cielo, and the Silver Star Resource Center (SSRC) for gang prevention and early intervention, the Truancy Program, and Alternative Education collaborations with the Monterey County Office of Education. The unit provides services in the continuum of care ranging from prevention and intervention to education and employment counseling in an effort to reduce the incidence of juvenile delinquency and gang involvement.

Recommended FY 2023-24 Positions

Classification Code	Classification Label	FTE
20B11	ACCOUNTANT II	1.00
60F02	PROBATION AIDE	5.50
60F22	DEPUTY PROBATION OFFICER II	4.00
60F23	DEPUTY PROBATION OFFICER III	2.00
60F84	PROBATION SERVICES MANAGER	2.00
80E21	OFFICE ASSISTANT II	2.00
Total		16.50

Alternative Programs

(Budget Unit 8162—Fund 022—Appropriation Unit PRO002)

Use of Funds

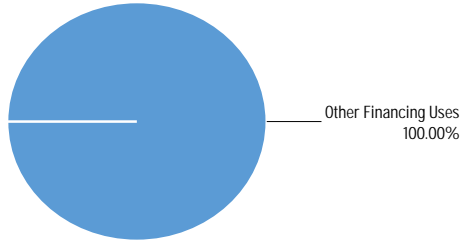

Source of Funds

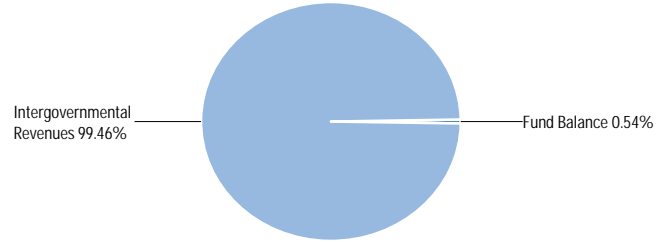

Use of Funds

Expenditures	Prior Year 2021-2022	Adopted Budget 2022-2023	CY Estimate 2022-2023	Requested Budget 2023-2024	Recommended Budget 2023-2024	Recommended Change from Adopted
Other Financing Uses	\$4,074,184	\$2,185,708	\$2,185,708	\$2,184,312	\$2,184,312	\$(1,396)
Subtotal	\$4,074,184	\$2,185,708	\$2,185,708	\$2,184,312	\$2,184,312	\$(1,396)

Source of Funds

Revenues	Prior Year 2021-2022	Adopted Budget 2022-2023	CY Estimate 2022-2023	Requested Budget 2023-2024	Recommended Budget 2023-2024	Recommended Change from Adopted
Intergovernmental Revenues	\$4,793,946	\$1,990,903	\$1,960,001	\$2,172,486	\$2,172,486	\$181,583
Subtotal	\$4,793,946	\$1,990,903	\$1,960,001	\$2,172,486	\$2,172,486	\$181,583
Fund Balance	\$(719,763)	\$194,805	\$225,707	\$11,826	\$11,826	\$(182,979)
Total Source of Funds	\$4,074,184	\$2,185,708	\$2,185,708	\$2,184,312	\$2,184,312	\$(1,396)

Unit Description

The Fiscal Year 2011-12 State Budget enacted a shift - or "realignment" - of State program responsibilities and revenues to local governments. To support the various realigned criminal justice, mental health, and social services programs, the Legislature passed Assembly Bill 118 (Chapter 40, Statutes of 2011). AB 118 created the new Local Revenue Fund 2011, in which a portion of State sales tax

and vehicle license fee revenues are deposited, and provided an accounting structure. For transparency in reporting, the County established Fund 022 to account for all public safety realignment revenues related to the Local Revenue Fund. Operating transfers occur between the General Fund and Fund 022 for realignment programs' payments.

Juvenile Hall

(Budget Unit 8163—Fund 001—Appropriation Unit PRO001)

Use of Funds

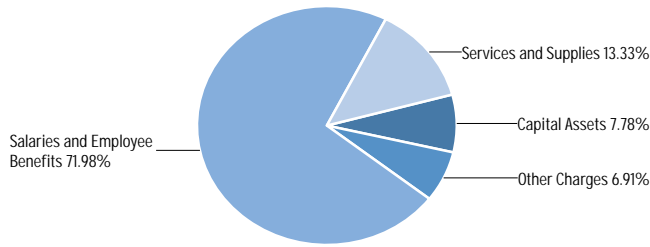

Source of Funds

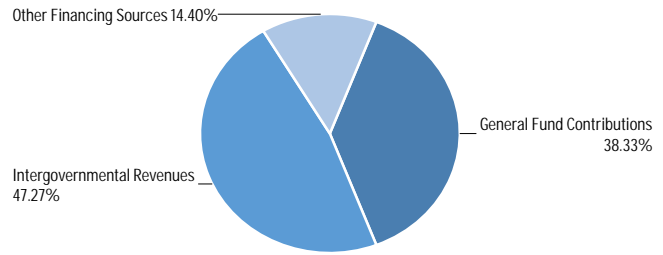

Use of Funds

Expenditures	Prior Year 2021-2022	Adopted Budget 2022-2023	CY Estimate 2022-2023	Requested Budget 2023-2024	Recommended Budget 2023-2024	Recommended Change from Adopted
Salaries and Employee Benefits	\$9,048,612	\$11,665,966	\$11,665,966	\$12,166,315	\$12,166,315	\$500,349
Services and Supplies	\$781,731	\$1,128,588	\$1,128,588	\$2,253,442	\$2,253,442	\$1,124,854
Other Charges	\$587,260	\$947,549	\$947,549	\$1,168,014	\$1,168,014	\$220,465
Capital Assets	\$8,703	—	—	\$1,314,478	\$1,314,478	\$1,314,478
Subtotal	\$10,426,306	\$13,742,103	\$13,742,103	\$16,902,249	\$16,902,249	\$3,160,146

Source of Funds

Revenues	Prior Year 2021-2022	Adopted Budget 2022-2023	CY Estimate 2022-2023	Requested Budget 2023-2024	Recommended Budget 2023-2024	Recommended Change from Adopted
Intergovernmental Revenues	\$2,171,533	\$4,561,047	\$4,561,047	\$7,987,268	\$7,987,268	\$3,426,221
Charges for Services	\$78,590	\$4,500	\$4,500	\$4,500	\$4,500	—
Miscellaneous Revenues	\$12,284	—	—	—	—	—
Other Financing Sources	\$2,457,214	\$2,790,765	\$2,790,765	\$2,433,265	\$2,433,265	\$(357,500)
Subtotal	\$4,719,621	\$7,356,312	\$7,356,312	\$10,425,033	\$10,425,033	\$3,068,721
General Fund Contributions	\$5,706,685	\$6,385,791	\$6,385,791	\$6,477,216	\$6,477,216	\$91,425
Total Source of Funds	\$10,426,306	\$13,742,103	\$13,742,103	\$16,902,249	\$16,902,249	\$3,160,146

Unit Description

The Monterey County Juvenile Hall is an 80-bed secure treatment facility that provides services to in-custody youth awaiting adjudication or disposition from Juvenile Court, as well as a secure youth treatment program for those youth that have been determined by the Juvenile Court to require rehabilitation and treatment within a highly structured custodial setting. Additionally, the department operates the Home Supervision and the Temporary Electronic Monitoring Programs as detention alternatives that enable youth to return to their homes during the court process.

Referrals to Juvenile Hall are received from countywide law enforcement agencies, the Probation Department, and the Superior Court. Services are provided to youth to assist with their reintegration into the community and address their educational, physical, behavioral, psychological and emotional needs within a trauma-informed setting. Youth committed to the Secure Youth Treatment Program receive intensive intervention designed to help youth develop life skills, learn emotional management and problem-solving

skills, develop an awareness about the dynamic factors that have resulted in law enforcement involvement, as well as benefit from a full continuum of cognitive and mental health services geared towards supporting long term success both in and out of the custody setting.

Recommended FY 2023-24 Positions

Classification Code	Classification Label	FTE
60F02	PROBATION AIDE	3.00
60F22	DEPUTY PROBATION OFFICER II	1.00
60F23	DEPUTY PROBATION OFFICER III	1.00
60F84	PROBATION SERVICES MANAGER	1.00
60F85	PROBATION DIVISION MANAGER	1.00
60F87	JUVENILE INSTITUTIONS SUPERVISOR	5.00
60F89	JUVENILE INSTITUTIONS OFFICER II	49.00
60F90	SENIOR JUVENILE INSTITUTIONS OFFICER	9.00

Recommended FY 2023-24 Positions

Classification Code	Classification Label	FTE
72A23	BUILDING MAINTENANCE WORKER	1.00
72A29	SENIOR BUILDING MAINTENANCE WORKER	1.00
80A30	SECRETARIAL ASSISTANT	1.00
80E21	OFFICE ASSISTANT II	1.00
Total		74.00

Youth Center

(Budget Unit 8164—Fund 001—Appropriation Unit PRO001)

Use of Funds

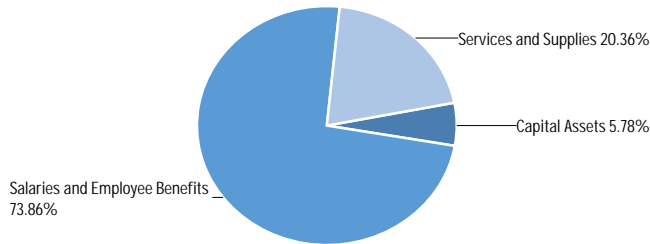

Source of Funds

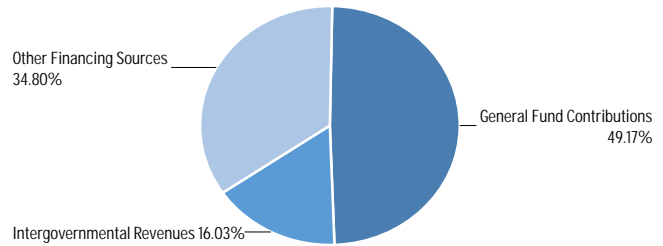

Use of Funds

Expenditures	Prior Year 2021-2022	Adopted Budget 2022-2023	CY Estimate 2022-2023	Requested Budget 2023-2024	Recommended Budget 2023-2024	Recommended Change from Adopted
Salaries and Employee Benefits	\$7,394,179	\$8,582,640	\$8,584,151	\$8,445,501	\$8,445,501	\$(137,139)
Services and Supplies	\$2,057,556	\$2,241,619	\$2,210,183	\$2,328,211	\$2,328,211	\$86,592
Capital Assets	\$5,298	—	—	\$660,483	\$660,483	\$660,483
Subtotal	\$9,457,034	\$10,824,259	\$10,794,334	\$11,434,195	\$11,434,195	\$609,936

Source of Funds

Revenues	Prior Year 2021-2022	Adopted Budget 2022-2023	CY Estimate 2022-2023	Requested Budget 2023-2024	Recommended Budget 2023-2024	Recommended Change from Adopted
Intergovernmental Revenues	\$937,002	\$1,372,287	\$1,372,287	\$1,831,936	\$1,831,936	\$459,649
Charges for Services	\$10,355	—	—	—	—	—
Miscellaneous Revenues	\$3,924	\$5,996	\$5,996	\$5,996	\$5,996	—
Other Financing Sources	\$3,142,170	\$3,844,775	\$3,844,775	\$3,977,524	\$3,977,524	\$132,749
Subtotal	\$4,093,451	\$5,223,058	\$5,223,058	\$5,815,456	\$5,815,456	\$592,398
General Fund Contributions	\$5,363,583	\$5,601,201	\$5,571,276	\$5,618,739	\$5,618,739	\$17,538
Total Source of Funds	\$9,457,034	\$10,824,259	\$10,794,334	\$11,434,195	\$11,434,195	\$609,936

Unit Description

The Monterey County Youth Center is a local secure treatment facility and aftercare program designed for Monterey County Juvenile Court wards. The Youth Center is comprised of four dormitories with a total capacity of 60 male residents. The program's cognitive behavioral approach is focused on building trusting relationships with positive adult role models (staff), developing better decision-making skills and learning strategies to reduce anger by attending group and individual counseling sessions along with receiving substance abuse, mental health and educational services.

Rehabilitation opportunities are offered in collaboration with other County agencies and departments, as well as private and business sectors of the community. The Youth Center's environment is designed to address anti-social/illegal behavior and thinking patterns in youth while promoting acceptance of personal responsibility, increasing self-awareness, enhancing resilience and personal coping mechanisms, and encouraging pro-social attitudes and behaviors.

The Aftercare/Reentry portion of the program is spent in the community and can last from six to twelve months. All residents are placed on electronic monitoring when they first start aftercare. The goal of reentry is to transition the youth successfully back into their family and the community through supervision, connection to resources and continued therapeutic treatment and support.

Recommended FY 2023-24 Positions

Classification Code	Classification Label	FTE
60F02	PROBATION AIDE	3.00
60F22	DEPUTY PROBATION OFFICER II	2.00
60F23	DEPUTY PROBATION OFFICER III	2.00
60F84	PROBATION SERVICES MANAGER	1.00
60F85	PROBATION DIVISION MANAGER	1.00
60F87	JUVENILE INSTITUTIONS SUPERVISOR	4.00
60F89	JUVENILE INSTITUTIONS OFFICER II	24.00

Recommended FY 2023-24 Positions

Classification Code	Classification Label	FTE
60F90	SENIOR JUVENILE INSTITUTIONS OFFICER	4.00
70K23	COOK	5.00
70K25	SENIOR COOK	1.00
70K80	HEAD COOK	1.00
70K83	FOOD ADMINISTRATOR-PROBATION	1.00
80E21	OFFICE ASSISTANT II	1.00
80E22	OFFICE ASSISTANT III	1.00
Total		51.00

Youth Center

(Budget Unit 8164—Fund 022—Appropriation Unit PRO002)

Use of Funds

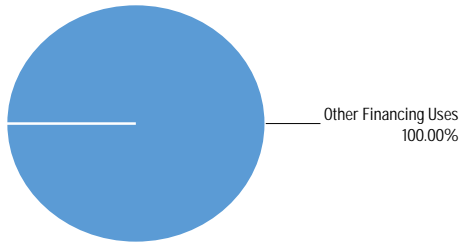

Source of Funds

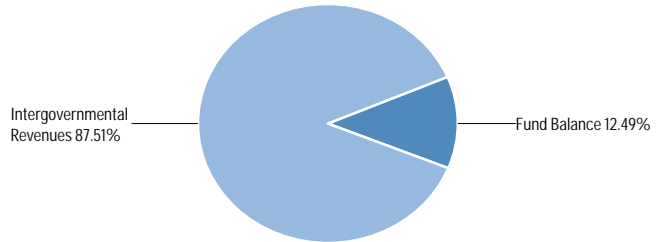

Use of Funds

Expenditures	Prior Year 2021-2022	Adopted Budget 2022-2023	CY Estimate 2022-2023	Requested Budget 2023-2024	Recommended Budget 2023-2024	Recommended Change from Adopted
Other Financing Uses	\$3,968,646	\$9,566,355	\$9,647,519	\$8,822,176	\$8,822,176	\$(744,179)
Subtotal	\$3,968,646	\$9,566,355	\$9,647,519	\$8,822,176	\$8,822,176	\$(744,179)

Source of Funds

Revenues	Prior Year 2021-2022	Adopted Budget 2022-2023	CY Estimate 2022-2023	Requested Budget 2023-2024	Recommended Budget 2023-2024	Recommended Change from Adopted
Intergovernmental Revenues	\$2,901,304	\$6,533,595	\$7,767,744	\$7,720,641	\$7,720,641	\$1,187,046
Subtotal	\$2,901,304	\$6,533,595	\$7,767,744	\$7,720,641	\$7,720,641	\$1,187,046
Fund Balance	\$1,067,342	\$3,032,760	\$1,879,775	\$1,101,535	\$1,101,535	\$(1,931,225)
Total Source of Funds	\$3,968,646	\$9,566,355	\$9,647,519	\$8,822,176	\$8,822,176	\$(744,179)

Unit Description

The Fiscal Year 2011-12 State Budget enacted a shift - or "realignment" - of State program responsibilities and revenues to local governments. To support the various realigned criminal justice, mental health, and social services programs, the Legislature passed Assembly Bill 118 (Chapter 40, Statutes of 2011). AB 118 created the new Local Revenue Fund 2011, in which a portion of State sales tax

and vehicle license fee revenues are deposited, and provided an accounting structure. For transparency in reporting, the County established Fund 022 to account for all public safety realignment revenues related to the Local Revenue Fund. Operating transfers occur between the General Fund and Fund 022 for realignment programs' payments.

Adult Probation

(Budget Unit 8165—Fund 001—Appropriation Unit PRO001)

Use of Funds

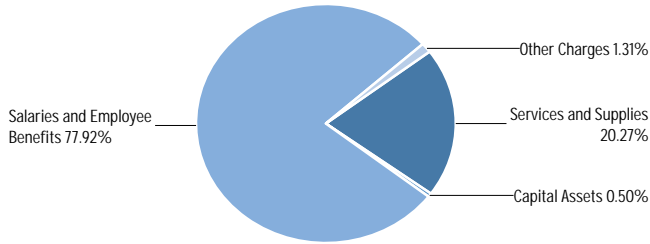

Source of Funds

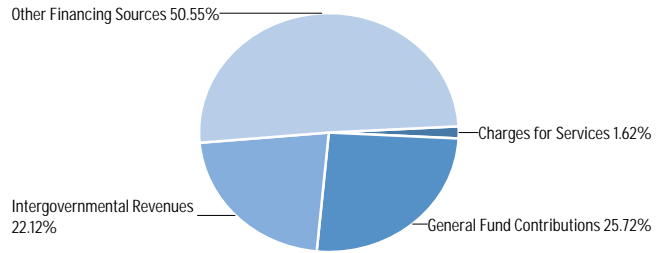

Use of Funds

Expenditures	Prior Year 2021-2022	Adopted Budget 2022-2023	CY Estimate 2022-2023	Requested Budget 2023-2024	Recommended Budget 2023-2024	Recommended Change from Adopted
Salaries and Employee Benefits	\$14,240,075	\$16,538,976	\$16,544,928	\$16,521,803	\$16,521,803	\$(17,173)
Services and Supplies	\$2,877,899	\$3,622,382	\$3,618,985	\$4,297,356	\$4,297,356	\$674,974
Other Charges	\$203,779	\$205,756	\$205,756	\$277,169	\$277,169	\$71,413
Capital Assets	\$66,663	—	—	\$106,478	\$106,478	\$106,478
Subtotal	\$17,388,417	\$20,367,114	\$20,369,669	\$21,202,806	\$21,202,806	\$835,692

Source of Funds

Revenues	Prior Year 2021-2022	Adopted Budget 2022-2023	CY Estimate 2022-2023	Requested Budget 2023-2024	Recommended Budget 2023-2024	Recommended Change from Adopted
Fines, Forfeitures, and Penalties	\$1,918	\$6,572	\$6,572	\$6,572	\$6,572	—
Intergovernmental Revenues	\$5,459,756	\$4,160,660	\$4,160,660	\$4,687,800	\$4,687,800	\$527,140
Charges for Services	\$126,513	\$343,131	\$343,131	\$343,131	\$343,131	—
Miscellaneous Revenues	—	\$2,000	\$2,000	\$2,000	\$2,000	—
Other Financing Sources	\$7,209,546	\$10,617,957	\$10,617,957	\$10,712,664	\$10,712,664	\$94,707
Subtotal	\$12,797,733	\$15,130,320	\$15,130,320	\$15,752,167	\$15,752,167	\$621,847
General Fund Contributions	\$4,590,684	\$5,236,794	\$5,239,349	\$5,450,639	\$5,450,639	\$213,845
Total Source of Funds	\$17,388,417	\$20,367,114	\$20,369,669	\$21,202,806	\$21,202,806	\$835,692

Unit Description

The Monterey County Adult Probation Division provides all adult services (court investigation, case management, and field supervision) for adult offenders as ordered by the sentencing court. These orders require actions such as victim restitution determination and collection, referral of adult offenders to community treatment interventions, drug testing, and probation compliance searches. Other services include supervision by global positioning system monitoring, Pretrial Services, Drug Treatment Court, Mental Health Court (Creating New Choices-CNC), Driving Under the Influence Court, Veterans Treatment Court, Adult Day Reporting Center, Adult Placement Program, general supervision caseloads, and specialized caseloads and services for sex offenders, gang members, and domestic violence (Family Violence Unit and Child Advocate Program).

Officers conduct risk and needs assessments including using the Ontario Domestic Assault Risk Assessment and the State Authorized Risk Assessment Tools for Sex Offenders. Officers create individualized case plans based on identified criminogenic needs for a roadmap to successfully supervise based on risk level and reintegrate into the community.

The Adult Division is also responsible for the community supervision of the realigned population returning from the California Department of Corrections and Rehabilitation. In addition to the supervision of these populations, this responsibility also entails coordination with local law enforcement agencies, the State, Monterey County Jail, community partners, and Superior Court.

Recommended FY 2023-24 Positions

Classification Code	Classification Label	FTE
14C30	MANAGEMENT ANALYST II	1.00
14C31	MANAGEMENT ANALYST III	1.00
16C87	BUSINESS TECHNOLOGY ANALYST II	1.00
20B10	ACCOUNTANT I	1.00
60F02	PROBATION AIDE	5.00
60F22	DEPUTY PROBATION OFFICER II	45.00
60F23	DEPUTY PROBATION OFFICER III	14.00
60F84	PROBATION SERVICES MANAGER	6.00

Recommended FY 2023-24 Positions

Classification Code	Classification Label	FTE
60F85	PROBATION DIVISION MANAGER	1.00
60I02	PROGRAM MANAGER II	1.00
60K02	VICTIM ASSISTANCE ADVOCATE	2.00
80A32	SENIOR SECRETARY	1.00
80E21	OFFICE ASSISTANT II	8.00
80E22	OFFICE ASSISTANT III	3.00
80E82	SUPERVISING OFFICE ASSISTANT II	1.00
Total		91.00

Adult Probation

(Budget Unit 8165—Fund 022—Appropriation Unit PRO002)

Use of Funds

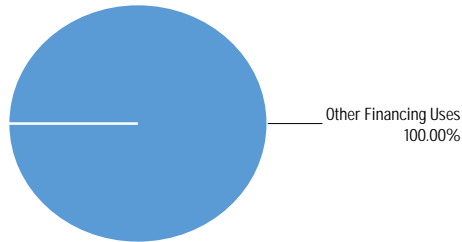

Source of Funds

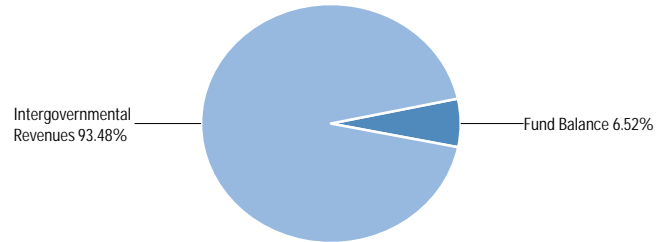

Use of Funds

Expenditures	Prior Year 2021-2022	Adopted Budget 2022-2023	CY Estimate 2022-2023	Requested Budget 2023-2024	Recommended Budget 2023-2024	Recommended Change from Adopted
Other Financing Uses	\$15,209,681	\$20,108,409	\$20,108,409	\$21,687,481	\$21,687,481	\$1,579,072
Subtotal	\$15,209,681	\$20,108,409	\$20,108,409	\$21,687,481	\$21,687,481	\$1,579,072

Source of Funds

Revenues	Prior Year 2021-2022	Adopted Budget 2022-2023	CY Estimate 2022-2023	Requested Budget 2023-2024	Recommended Budget 2023-2024	Recommended Change from Adopted
Intergovernmental Revenues	\$20,256,168	\$20,715,969	\$22,338,373	\$20,273,052	\$20,273,052	\$(442,917)
Subtotal	\$20,256,168	\$20,715,969	\$22,338,373	\$20,273,052	\$20,273,052	\$(442,917)
Fund Balance	\$(5,046,487)	\$(607,560)	\$(2,229,964)	\$1,414,429	\$1,414,429	\$2,021,989
Total Source of Funds	\$15,209,681	\$20,108,409	\$20,108,409	\$21,687,481	\$21,687,481	\$1,579,072

Unit Description

The Fiscal Year 2011-12 State Budget enacted a shift - or "realignment" - of State program responsibilities and revenues to local governments. To support the various realigned criminal justice, mental health, and social services programs, the Legislature passed Assembly Bill 118 (Chapter 40, Statutes of 2011). AB 118 created the new Local Revenue Fund 2011, in which a portion of State sales tax

and vehicle license fee revenues are deposited, and provided an accounting structure. For transparency in reporting, the County established Fund 022 to account for all public safety realignment revenues related to the Local Revenue Fund. Operating transfers occur between the General Fund and Fund 022 for realignment programs' payments.

Juvenile Probation

(Budget Unit 8166—Fund 001—Appropriation Unit PRO001)

Use of Funds

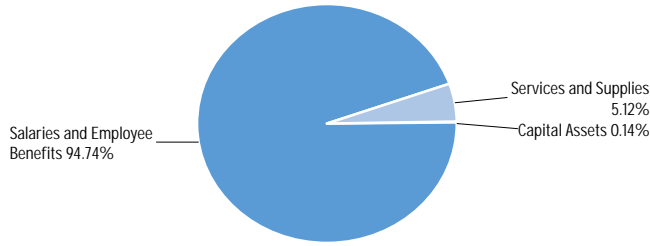

Source of Funds

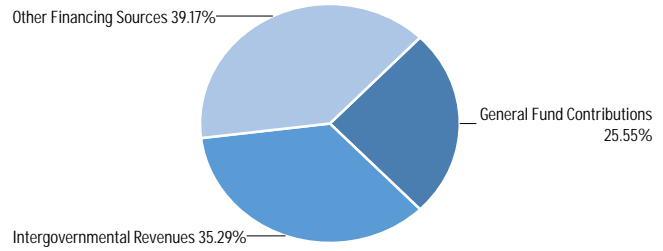

Use of Funds

Expenditures	Prior Year 2021-2022	Adopted Budget 2022-2023	CY Estimate 2022-2023	Requested Budget 2023-2024	Recommended Budget 2023-2024	Recommended Change from Adopted
Salaries and Employee Benefits	\$7,187,010	\$8,241,758	\$8,243,696	\$8,469,695	\$8,469,695	\$227,937
Services and Supplies	\$389,750	\$444,015	\$444,015	\$457,795	\$457,795	\$13,780
Other Charges	\$(222,566)	\$(188,188)	\$(188,188)	\$(222,566)	\$(222,566)	\$(34,378)
Capital Assets	\$11,700	—	—	\$12,115	\$12,115	\$12,115
Subtotal	\$7,365,894	\$8,497,585	\$8,499,523	\$8,717,039	\$8,717,039	\$219,454

Source of Funds

Revenues	Prior Year 2021-2022	Adopted Budget 2022-2023	CY Estimate 2022-2023	Requested Budget 2023-2024	Recommended Budget 2023-2024	Recommended Change from Adopted
Intergovernmental Revenues	\$3,468,614	\$2,713,487	\$2,713,487	\$3,075,340	\$3,075,340	\$361,853
Charges for Services	\$59,615	—	—	—	—	—
Miscellaneous Revenues	—	\$2,000	\$2,000	\$2,000	\$2,000	—
Other Financing Sources	\$2,147,996	\$3,689,077	\$3,689,077	\$3,413,361	\$3,413,361	\$(275,716)
Subtotal	\$5,676,225	\$6,404,564	\$6,404,564	\$6,490,701	\$6,490,701	\$86,137
General Fund Contributions	\$1,689,670	\$2,093,021	\$2,094,959	\$2,226,338	\$2,226,338	\$133,317
Total Source of Funds	\$7,365,894	\$8,497,585	\$8,499,523	\$8,717,039	\$8,717,039	\$219,454

Unit Description

The Monterey County Juvenile Probation Division consists of intake, diversion and early intervention services, court investigation, and field supervision. Services include victim restitution, restorative justice programs, the Campus-based Probation Officer program, a specialized juvenile sex offender program (Juveniles who Sexually Offend Response Team-JSORT), juvenile drug court, and juvenile special services, such as wraparound, mental health assessments and a mental health court (Collaborative Action Linking Adolescents-CALA), and out-of-home placement.

Orders of probation require a variety of activities, including drug testing, the collection of victim restitution, probation searches, the monitoring of school performance, and referrals of youth and families to various community treatment interventions, conducting risk and needs assessments to identify criminogenic needs and determine if the youth is at-risk of being a candidate for foster care, and monitoring youth's progress to enable them to meet their rehabilitative goals.

Recommended FY 2023-24 Positions

Classification Code	Classification Label	FTE
14C30	MANAGEMENT ANALYST II	1.00
60F02	PROBATION AIDE	3.00
60F22	DEPUTY PROBATION OFFICER II	22.00
60F23	DEPUTY PROBATION OFFICER III	6.00
60F84	PROBATION SERVICES MANAGER	3.00
60F85	PROBATION DIVISION MANAGER	1.00
80E21	OFFICE ASSISTANT II	4.00
80E22	OFFICE ASSISTANT III	4.00
80E82	SUPERVISING OFFICE ASSISTANT II	1.00
80W21	WORD PROCESSOR	2.00
Total		47.00

Juvenile Probation

(Budget Unit 8166—Fund 022—Appropriation Unit PRO002)

Use of Funds

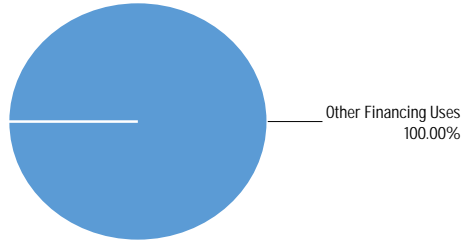

Source of Funds

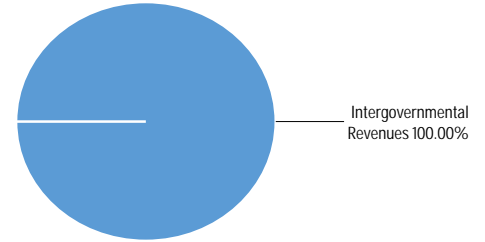

Use of Funds

Expenditures	Prior Year 2021-2022	Adopted Budget 2022-2023	CY Estimate 2022-2023	Requested Budget 2023-2024	Recommended Budget 2023-2024	Recommended Change from Adopted
Other Financing Uses	\$608,777	\$388,035	\$376,789	\$388,035	\$388,035	—
Subtotal	\$608,777	\$388,035	\$376,789	\$388,035	\$388,035	—

Source of Funds

Revenues	Prior Year 2021-2022	Adopted Budget 2022-2023	CY Estimate 2022-2023	Requested Budget 2023-2024	Recommended Budget 2023-2024	Recommended Change from Adopted
Intergovernmental Revenues	\$616,478	\$388,035	\$376,789	\$388,035	\$388,035	—
Subtotal	\$616,478	\$388,035	\$376,789	\$388,035	\$388,035	—
Fund Balance	\$(7,701)	—	—	—	—	—
Total Source of Funds	\$608,777	\$388,035	\$376,789	\$388,035	\$388,035	—

Unit Description

The Fiscal Year 2011-12 State Budget enacted a shift - or "realignment" - of State program responsibilities and revenues to local governments. To support the various realigned criminal justice, mental health, and social services programs, the Legislature passed Assembly Bill 118 (Chapter 40, Statutes of 2011). AB 118 created the new Local Revenue Fund 2011, in which a portion of State sales tax

and vehicle license fee revenues are deposited, and provided an accounting structure. For transparency in reporting, the County established Fund 022 to account for all public safety realignment revenues related to the Local Revenue Fund. Operating transfers occur between the General Fund and Fund 022 for realignment programs' payments.

Probation Administration

(Budget Unit 8167—Fund 001—Appropriation Unit PRO001)

Use of Funds

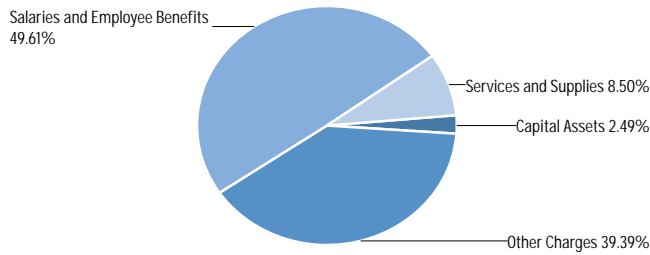

Source of Funds

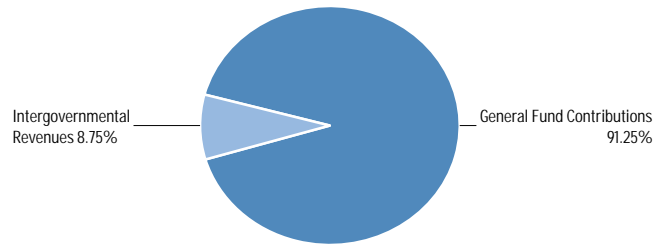

Use of Funds

Expenditures	Prior Year 2021-2022	Adopted Budget 2022-2023	CY Estimate 2022-2023	Requested Budget 2023-2024	Recommended Budget 2023-2024	Recommended Change from Adopted
Salaries and Employee Benefits	\$3,065,661	\$3,307,766	\$3,323,162	\$3,477,012	\$3,374,908	\$67,142
Services and Supplies	\$402,321	\$554,456	\$554,456	\$578,216	\$578,216	\$23,760
Other Charges	\$3,174,946	\$3,152,001	\$3,152,001	\$2,679,749	\$2,679,749	\$(472,252)
Capital Assets	\$110,857	—	—	\$169,552	\$169,552	\$169,552
Subtotal	\$6,753,785	\$7,014,223	\$7,029,619	\$6,904,529	\$6,802,425	\$(211,798)

Source of Funds

Revenues	Prior Year 2021-2022	Adopted Budget 2022-2023	CY Estimate 2022-2023	Requested Budget 2023-2024	Recommended Budget 2023-2024	Recommended Change from Adopted
Intergovernmental Revenues	\$145,766	\$698,137	\$698,137	\$595,048	\$595,048	\$(103,089)
Charges for Services	\$10,300	—	—	—	—	—
Miscellaneous Revenues	\$31	—	—	—	—	—
Subtotal	\$156,097	\$698,137	\$698,137	\$595,048	\$595,048	\$(103,089)
General Fund Contributions	\$6,597,687	\$6,316,086	\$6,331,482	\$6,309,481	\$6,207,377	\$(108,709)
Total Source of Funds	\$6,753,785	\$7,014,223	\$7,029,619	\$6,904,529	\$6,802,425	\$(211,798)

Unit Description

The Administration Division manages a wide range of services for the department, including fiscal, contract, human resources and employee training and development (including arming for sworn officers), facilities, fleet, and information technology.

Recommended FY 2023-24 Positions

Classification Code	Classification Label	FTE
11A06	CHIEF PROBATION OFFICER	1.00
12C35	ASSISTANT CHIEF PROBATION OFFICER	1.00
14B32	SENIOR PERSONNEL ANALYST	1.00
14C30	MANAGEMENT ANALYST II	1.00
14C31	MANAGEMENT ANALYST III	1.00
14H03	PERSONNEL TECHNICIAN-CONFIDENTIAL	1.00
16C87	BUSINESS TECHNOLOGY ANALYST II	1.00

Recommended FY 2023-24 Positions

Classification Code	Classification Label	FTE
16F41	DEPARTMENTAL INFORMATION SYSTEMS MANAGER II	1.00
20B10	ACCOUNTANT I	1.00
20B12	ACCOUNTANT III	1.00
20B93	FINANCE MANAGER II	1.00
43J09	SENIOR DEPARTMENTAL INFORMATION SYSTEMS COORDINATOR	1.00
60F84	PROBATION SERVICES MANAGER	1.00
80A99	ADMINISTRATIVE SECRETARY-CONFIDENTIAL	1.00
80J22	SENIOR ACCOUNT CLERK	1.00
80J30	ACCOUNTING TECHNICIAN	4.00
Total		19.00

Agricultural Commissioner

Departmental Overview/ Description:

The Agricultural Commissioner/Sealer of Weights and Measures is required by law to act as the local enforcement agency for specific laws and regulations pertaining to agriculture and business. Responsibilities include protecting the health and safety of workers, the public, and the environment; safeguarding the County from the introduction of harmful pests and diseases detrimental to agriculture; promoting and protecting agriculture; and assuring business and consumer confidence in the marketplace.

Programs and Functions:

Pesticide use enforcement, plant quarantine, pest exclusion, pest detection, fruit and vegetable standardization, nursery, seed, and weights and measures enforcement are major programs. The Agricultural Commissioner also performs pest management activities within the County and provides phytosanitary certification services that enable export of our agricultural products. An annual Crop Report tabulates the gross value of agricultural production in the County. Under the Sealer of Weights and Measures, staff registers and verifies the accuracy of all commercial weighing and measuring devices, to maintain equity in the marketplace and for the protection of the consumer.

Department's Contribution to Monterey County's Strategic Initiatives:

ECONOMIC DEVELOPMENT

Agricultural regulatory programs ensure a healthy and viable agricultural economy by maintaining a level playing field and excluding harmful pest and diseases and preventing illegal residues on agricultural commodities. Phytosanitary certification facilitates the exportation of agricultural products across the globe. Annual Crop and Livestock Reports and associated economic reports quantify the contribution of agriculture to the local economy. Agricultural education programs support the industry and educate policy makers. The Weights and Measures program maintains equity in the marketplace and protects consumers.

ADMINISTRATION

Active recruitment of women and minorities. Focus remains on retention and advancement with investment in training and fostering a culture of teamwork and inclusivity. Hybrid work models have been embraced and made available for all staff throughout the pandemic.

HEALTH AND HUMAN SERVICES

Pesticide Use Enforcement program protects farm workers, the public and the environment from pesticide exposure, and investigates all possible pesticide-related reports of illness, injury, drift, or environmental effect.

INFRASTRUCTURE

Prevention of excessive erosion protects County soil, roads and drainage systems. The Office contracts with the Resource Conservation District to aid small farmers to control erosion and holds an annual "Ag Expo" and seminars to educate Spanish-speaking growers about conservation practices.

PUBLIC SAFETY

Pesticide Use Enforcement program protects farm workers, the public and the environment from exposure to pesticides. Preventing the introduction of invasive pests eliminates the need to apply more pesticides.

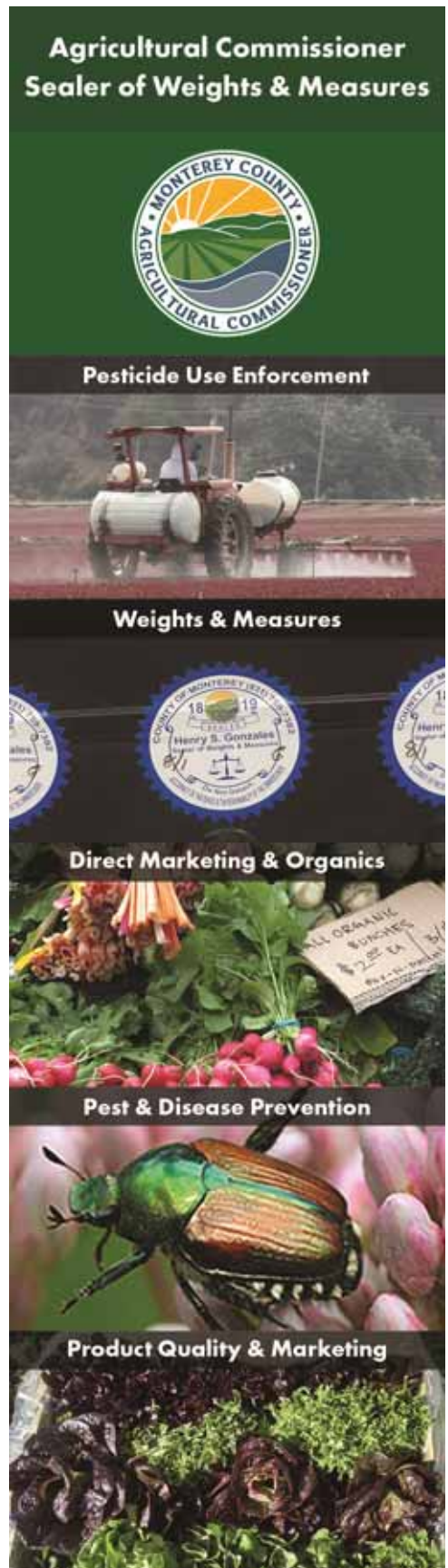

Operating Budget: \$13,735,191
Positions (FTEs): 75.00

Juan Hidalgo
Agricultural Commissioner

Agriculture

Weights and Measures

Staffing Trends

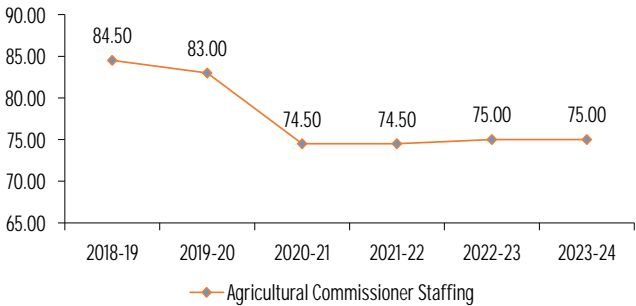

Expenditure/Revenue History (in millions)

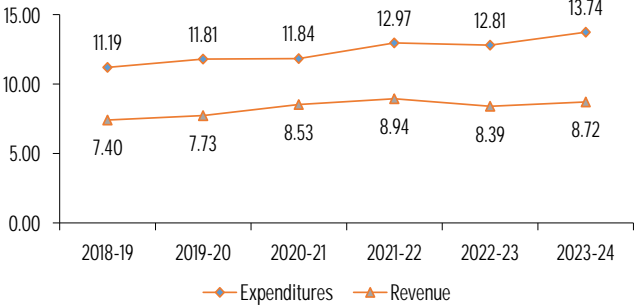

The Agricultural Commissioner enforces state and local regulations in concert with state agencies to protect agriculture, human health and safety, and the environment. Primary programs are pesticide use enforcement, plant quarantine, and fruit and vegetable standardization.

Key Performance Measures	2020-21 Actual	2021-22 Actual	2022-23 Mid-Year
Phytosanitary Certificates for Commodity Export issued.	21,175	22,927	13,646
Pest detection traps set for target insects.	5,683	27,848	3,039
Pesticide use monitoring inspections completed.	1,497	1,859	871
Pesticide Use Training and Outreach Sessions delivered.	7	20	18
Weighing and Measuring Devices inspected.	9,001	7,949	6,632
Consumer complains investigated.	21	33	16

Use of Funds

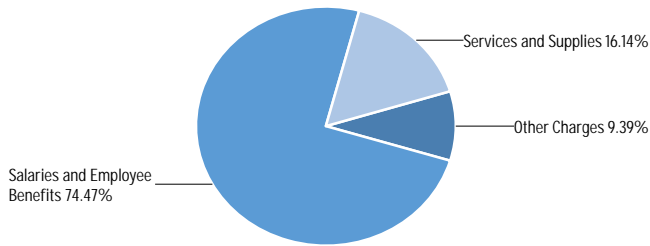

Source of Funds

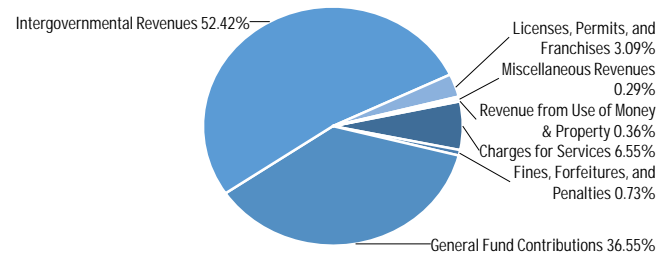

Use of Funds

Expenditures	Prior Year 2021-2022	Adopted Budget 2022-2023	CY Estimate 2022-2023	Requested Budget 2023-2024	Recommended Budget 2023-2024	Recommended Change from Adopted
Salaries and Employee Benefits	\$9,670,698	\$9,976,901	\$9,271,899	\$10,228,931	\$10,228,931	\$252,030
Services and Supplies	\$2,104,802	\$1,837,798	\$2,317,592	\$2,216,475	\$2,216,475	\$378,677
Other Charges	\$1,191,504	\$1,223,601	\$1,223,601	\$1,289,785	\$1,289,785	\$66,184
Subtotal	\$12,967,003	\$13,038,300	\$12,813,092	\$13,735,191	\$13,735,191	\$696,891

Source of Funds

Revenues	Prior Year 2021-2022	Adopted Budget 2022-2023	CY Estimate 2022-2023	Requested Budget 2023-2024	Recommended Budget 2023-2024	Recommended Change from Adopted
Licenses, Permits, and Franchises	\$425,319	\$432,500	\$432,500	\$425,000	\$425,000	\$(7,500)
Fines, Forfeitures, and Penalties	\$140,635	\$50,000	\$50,000	\$100,000	\$100,000	\$50,000
Revenue from Use of Money & Property	\$46,700	—	\$65,000	\$50,000	\$50,000	\$50,000
Intergovernmental Revenues	\$7,421,103	\$6,900,000	\$6,900,000	\$7,200,000	\$7,200,000	\$300,000
Charges for Services	\$869,180	\$900,000	\$900,000	\$900,000	\$900,000	—
Miscellaneous Revenues	\$32,582	\$40,100	\$40,000	\$40,100	\$40,100	—
Subtotal	\$8,935,519	\$8,322,600	\$8,387,500	\$8,715,100	\$8,715,100	\$392,500
General Fund Contributions	\$4,031,484	\$4,715,700	\$4,425,592	\$5,020,091	\$5,020,091	\$304,391
Total Source of Funds	\$12,967,003	\$13,038,300	\$12,813,092	\$13,735,191	\$13,735,191	\$696,891

Summary of Recommendation

The Recommended Budget for the Agricultural Commissioner's Office is \$13,735,191 financed by \$8,715,100 in revenues and \$5,020,091 in General Fund Contributions (GFC). The Recommended Budget increases appropriations by \$696,891, driven by higher employee wages and benefits, replacement of agricultural service equipment, higher non-recoverable general liability, and an increase in the cost plan charge. The increase in appropriations is financed by higher Unclaimed Gasoline Tax and Mill Tax and additional GFC allocated to the Department.

The Recommended Budget includes 75.0 positions, no change from the prior fiscal year.

Budget Impacts

There are no budget impacts.

Prior Year Accomplishments

The Weights & Measures division conducted quality control inspections throughout the County. Weights & Measures inspectors reviewed thousands of commercial devices at nearly 2,000 locations, ensuring compliance and protecting consumers.

Qualified for Unclaimed Gas Tax (UGT) and Mill Tax revenue by meeting Maintenance of Effort with the California Department of Food and Agriculture (CDFA) and California Department of Pesticide Regulation (CDPR). This ensures funding to maintain operations at the level required to address the needs of the agriculture industry.

Expanded an electronic dispatch system with all shippers and coolers. All Inspector/Biologists receive their dispatch calls electronically, resulting in improved staff efficiency and reduced clerical errors. All phytosanitary certificate requests are now digitally dispatched to the inspectors in the field.

Began the process of renovating a newly acquired facility in south Monterey County. The \$1.8 million location is scheduled to undergo renovations to convert the building into offices and storage, which

will allow the Department to serve agricultural industry needs to south Monterey County.

Pesticide use around schools continues to be a major focus of the Department. The [farmingsafelynearschools.com](https://www.farmingsafelynearschools.com) website remained fully operational and Pesticide Use Enforcement staff continued to provide information to parents and schools about agricultural pesticide use around the seven schools in the North Monterey County School District and three schools in the Pajaro Valley Unified School District, all within Monterey County. The website has English and Spanish language versions. Those requesting notifications can receive them via text message, and/or email.

Budget Year Goals

Retain Unclaimed Gas Tax (UGT) revenue by meeting Maintenance of Effort requirements as determined by the California Department of Food and Agriculture.

Continue and expand pesticide use enforcement activities with Cannabis cultivators, including active field enforcement.

Present case studies during continuing education sessions to growers and licensee holders, where basic information is shared from select priority illness investigations that are either recently completed or are in the process of completion. By sharing this information, attendees will become aware of the major incidents that occur in Monterey County, in the hope that with the knowledge gained, they may avoid making similar mistakes in the future.

Publish the 2022 Crop Report in English and Spanish to continue increasing readership.

Maintain current mapping data of weed populations by conducting ongoing weed site vegetation surveys. Initiate a voluntary Weed Free

Aggregate Certification Program for 10 active aggregate quarries operating in Monterey County.

Assist the agricultural industry in Monterey County in recovery from the damage incurred during the winter storms and flooding events in early 2023.

Continue updating department website with available information and resources to the agriculture industry and public. Included in these plans are exploring fine and registration payments through online bill pay used by other County of Monterey departments.

Pending Issues

The Department will work with the California Department of Food and Agriculture (CDFA) to continue exclusion and detection efforts for the European Grape Vine Moth, the Asian Citrus Psyllid, Glassy-winged Sharpshooter and other target pests of concern. Light Brown Apple Moth (LBAM) quarantines by Canada and Mexico continue to be an issue requiring significant staff resources. China has opened their borders to U.S Strawberries, and the protocol requires intensive inspection. Taiwan quarantine protocol also requires intensive inspections.

There is a continuing focus on regulation of pesticide use, especially fumigants, and particularly around school sites. This will result in a continuing dedication of staff resources to pesticide use enforcement issues and community outreach efforts. Regulations for the use of pesticides around schools required the dedication of significant staff time to work with schools and growers.

Policy Considerations

There are no policy considerations.

Appropriation Expenditure Detail

	Prior Year 2021-2022	Adopted Budget 2022-2023	CY Estimate 2022-2023	Requested Budget 2023-2024	Recommended Budget 2023-2024	Recommended Change from Adopted	Fund Code	Budget Unit Code
Agriculture/Weights & Measures (AGR001)	12,967,003	13,038,300	12,813,092	13,735,191	13,735,191	696,891	001	8001
Subtotal	12,967,003	13,038,300	12,813,092	13,735,191	13,735,191	696,891		

Budget Units

	Prior Year 2021-2022	Adopted Budget 2022-2023	CY Estimate 2022-2023	Requested Budget 2023-2024	Recommended Budget 2023-2024	Recommended Change from Adopted
Agriculture/Weights & Measures	\$12,967,003	\$13,038,300	\$12,813,092	\$13,735,191	13,735,191	\$696,891
Subtotal	\$12,967,003	\$13,038,300	\$12,813,092	\$13,735,191	13,735,191	\$696,891

Adopted FY 2022-23 to Recommended FY 2023-24 Positions

Classification Code	Classification Label	Adopted Budget 2021-2022	Adopted Budget 2022-2023	Recommended Budget 2023-2024	Change
11A02	AGRICULTURAL COMMISSIONER	1.00	1.00	1.00	0.00
12C01	ASSISTANT AGRICULTURAL COMMISSIONER	1.00	1.00	1.00	0.00
14B32	SENIOR PERSONNEL ANALYST	1.00	1.00	1.00	0.00
14C31	MANAGEMENT ANALYST III	1.00	1.00	1.00	0.00
14H03	PERSONNEL TECHNICIAN-CONFIDENTIAL	1.00	1.00	1.00	0.00
16G25	GIS ANALYST III	1.00	1.00	1.00	0.00
20B10	ACCOUNTANT I	1.00	1.00	1.00	0.00
20B95	FINANCE MANAGER I	1.00	1.00	1.00	0.00
30G22	WEIGHTS/MEASURES INSPECTOR III	5.50	5.00	5.00	0.00
30N05	AGRICULTURAL ASSISTANT II	11.00	11.00	11.00	0.00
30N22	AGRICULTURAL INSPECTOR/BIOLOGIST III	31.00	32.00	32.00	0.00
30N50	AGRICULTURAL PROGRAMS BIOLOGIST	1.00	1.00	1.00	0.00
30N80	DEPUTY AGRICULTURAL COMMISSIONER	8.00	8.00	8.00	0.00
30N81	CHIEF DEPUTY AGRICULTURAL COMMISSIONER	3.00	3.00	3.00	0.00
43J15	SUPERVISING DEPARTMENTAL INFORMATION SYSTEMS COORDINATOR	1.00	1.00	1.00	0.00
80A99	ADMINISTRATIVE SECRETARY-CONFIDENTIAL	1.00	1.00	1.00	0.00
80E22	OFFICE ASSISTANT III	2.00	2.00	2.00	0.00
80G21	DATA ENTRY OPERATOR II	1.00	1.00	1.00	0.00
80J22	SENIOR ACCOUNT CLERK	1.00	1.00	1.00	0.00
80J30	ACCOUNTING TECHNICIAN	1.00	1.00	1.00	0.00
Total		74.50	75.00	75.00	0.00



This page intentionally left blank.

Housing and Community Development

Departmental Overview:

The Department of Housing and Community Development (HCD) balances environmental protection with sustainable development. HCD brings together a range of land use services including housing, planning and development services to ensure reasonable and safe development, plan for future needs of the County, manage infrastructure and County facilities, and protect natural resources.

Programs and Functions:

The Department includes four divisions: Administrative Support, Development Services, Planning Services and Permit Center. Administrative Support provides budget, accounting, customer service, human resources, safety, secretarial support, and information. Development Services includes three sections: Building Services, Environmental Services and Engineering Services. Planning Services is composed of three sections: Advance Planning, Current Planning, and Housing. The Permit Center provides single point of contact and processing guidance for planning and construction related permits. The Permit Center also manages public records and the call center.

The Department's Contribution to Monterey County's Strategic Initiatives:

ECONOMIC DEVELOPMENT

Streamline the permitting and application process, as well as develop regulations that provide opportunities to generate increased tax revenues and facilitate safe affordable housing opportunities to support the Monterey County workforce.

ADMINISTRATION

Utilize performance measures to monitor key public services and track trends that form organizational improvements, budgeting priorities, and efficiencies.

HEALTH AND HUMAN SERVICES

Promote health in all land use policy documents. Support other County department efforts relative to special needs housing and programs. Consider environmental justice and racial equity factors and human health when preparing plans.

INFRASTRUCTURE

Ensure that projects and plans provide for adequate infrastructure funding and planning to maintain customer-expected service levels while protecting the natural environment.

PUBLIC SAFETY

HCD serves as one of the lead agencies for public safety in the unincorporated areas of the County, coordinates with other land use agencies on policy development and implementation, reviews and inspects development, and coordinates with other departments and agencies in cases of natural disasters. HCD ensure development is done in a manner that protects the health, safety and general welfare of the residents and visitors.



Operating Budget: \$27,975,050
Positions (FTEs): 103.00

Erik Lundquist
Director

Community Development

Housing

Staffing Trends

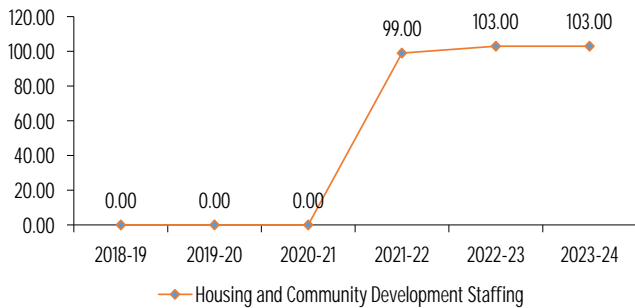

Expenditure/Revenue History (in millions)

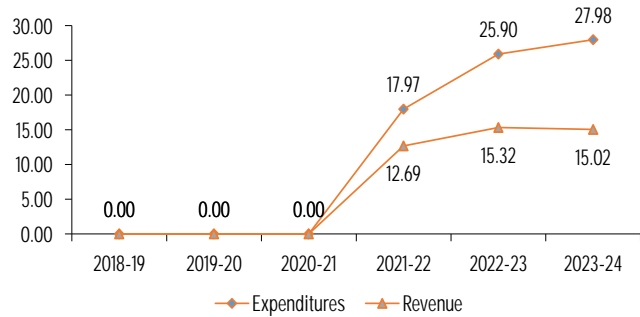

Housing and Community Development utilizes this performance measure to inform operational improvements, assist in developing budgets, and identify additional resources needed to achieve its targets. HCD is evaluating other processes and programs to establish additional key performance measures.

Key Performance Measures	2020-21 Actual	2021-22 Actual	2022-23 Mid-Year
Building permit plan review completed within 6-to-8-week timelines. Target = 100%	64%	67%	80%
Environmental Services permit plan review completed within 6-to-8 week timelines. Target = 100%	37%	34%	49%
Engineering Services permit plan review completed within 6-to-8-week timelines. Target = 100%	32%	56%	87%
Percentage of all construction permit inspections completed within one working day of request. Target = 100%	96%	98%	98%

Use of Funds

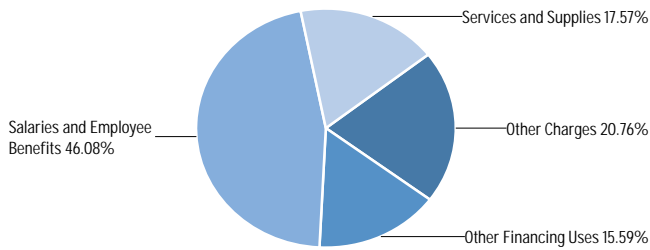

Source of Funds

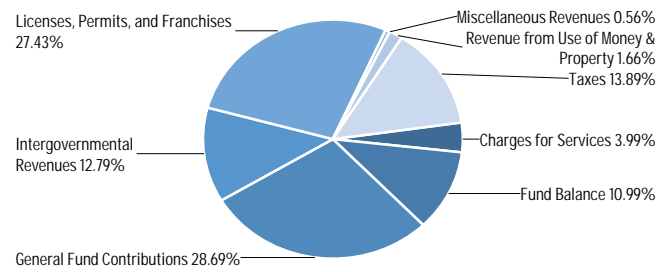

Use of Funds

Expenditures	Prior Year 2021-2022	Adopted Budget 2022-2023	CY Estimate 2022-2023	Requested Budget 2023-2024	Recommended Budget 2023-2024	Recommended Change from Adopted
Salaries and Employee Benefits	\$10,730,936	\$13,830,793	\$12,711,293	\$15,824,858	\$14,926,462	\$1,095,669
Services and Supplies	\$6,252,686	\$12,289,967	\$9,929,115	\$5,721,303	\$5,477,653	\$(6,812,314)
Other Charges	\$836,043	\$2,074,595	\$1,798,806	\$2,491,817	\$2,491,817	\$417,222
Capital Assets	\$147,368	—	\$27,794	\$28,284	\$28,284	\$28,284
Other Financing Uses	—	\$1,795,207	\$1,430,836	\$5,050,834	\$5,050,834	\$3,255,627
Subtotal	\$17,967,033	\$29,990,562	\$25,897,844	\$29,117,096	\$27,975,050	\$(2,015,512)

Source of Funds

Revenues	Prior Year 2021-2022	Adopted Budget 2022-2023	CY Estimate 2022-2023	Requested Budget 2023-2024	Recommended Budget 2023-2024	Recommended Change from Adopted
Licenses, Permits, and Franchises	\$8,051,404	\$7,468,782	\$8,459,426	\$8,885,436	\$8,885,436	\$1,416,654
Revenue from Use of Money & Property	\$398,471	\$533,192	\$527,320	\$494,796	\$494,796	\$(38,396)
Intergovernmental Revenues	\$1,947,064	\$7,313,134	\$4,447,823	\$4,144,568	\$4,144,568	\$(3,168,566)
Charges for Services	\$1,629,195	\$1,083,097	\$1,282,204	\$1,292,249	\$1,292,249	\$209,152
Miscellaneous Revenues	\$425,906	\$209,043	\$604,841	\$182,498	\$182,498	\$(26,545)
Other Financing Sources	\$238,775	\$62,964	—	\$24,851	\$24,851	\$(38,113)
Subtotal	\$12,690,815	\$16,670,212	\$15,321,614	\$15,024,398	\$15,024,398	\$(1,645,814)
Fund Balance	\$(151,767)	\$2,318,376	\$1,730,966	\$3,559,789	\$3,559,789	\$1,241,413
General Fund Contributions	\$5,427,985	\$11,001,974	\$8,845,264	\$10,532,909	\$9,390,863	\$(1,611,111)
Total Source of Funds	\$17,967,033	\$29,990,562	\$25,897,844	\$29,117,096	\$27,975,050	\$(2,015,512)

Summary of Recommendation

The Recommended Budget for the Housing and Community Development (HCD) Department contains \$28.0 million in expenditures, financed by \$15.0 million in program revenue, \$9.4 million in General Fund Contribution (GFC), and \$3.6 million in fund balance use. Expenditures decrease \$2.0 million over the Fiscal Year (FY) 2022-23 Adopted Budget primarily due to a \$6.8 million decrease in services and supplies for one-time funded consultant work and a change in methodology in the disbursements of Federal Aid within the Community Development Block Grant (CDBG) disbursements, offset by an increase in Salaries and Benefits of \$1.1 million due to Board of Supervisor approved MOU increases, as well as \$3.3 million in Other Financing Uses for Housing loans carried forward in Community Development Reuse Fund 013. Revenues decrease \$1.6 million primarily due to a \$3.2 million decrease in Intergovernmental Revenues for State and Federal Aid CDBG Disbursements, offset with an increase in estimated Construction Permit revenues of \$1.2 million. The Recommended Budget for the

HCD department includes 103 positions, status quo from the FY 2022-23 Adopted Budget.

Budget Impacts

HCD submitted ten augmentations totaling almost \$1,462,952 that may be categorized as Department Programs and County Programs. Two of these are included in the Recommended Budget:

- 1) General Plan Housing and Safety Element Update and Preparation of Environmental Justice Element, \$270,906
- 2) Chualar Community Plan, \$50,000.

Augmentations not funded include; consultant work to assist in completion of the Short-Term Vacation Rental Ordinance \$123,650; Housekeys housing services, including identifying, organizing, and communicating the County’s inclusionary housing inventory to assist very low, low and moderate income residents, \$120,000; and six new

positions to support the services provided to County residents, \$898,396.

Prior Year Accomplishments

Goal 1 Administrative Support: Further develop and refine the planning permit cost recovery system related to projects that have a developer deposit rather than a flat fee. Manage all departmental hearing bodies through Legistar-Granicus and train staff on the system. Cross train the secretarial staff on various divisions and section needs.

The department has been successful in establishing a method to track time worked on deposit projects resulting in the ability to recognize revenues timely. With the return to in person hearings the department is utilizing Legistar and can cross train staff on various duties associated with public hearings.

Goal 2 Development Services: Execute Accessory Dwelling Unit (ADU) Pre-Approved Plans Program to provide new opportunities for housing, initiate California Building Standards Code cycle update, reform solar and the over-the-counter permit program to reduce unnecessary processes and reduce costs to customers, and continue emergency rebuild efforts.

The department has completed Pre-Approved Plans for Accessory Dwelling Units (ADU) applications to provide new opportunities for housing. Implemented California Building Standards Code cycle update. Purchased software to reform solar applications. Implemented the over-the-counter permit program to reduce unnecessary processes and reduce costs to customers, and continue emergency rebuild efforts.

Goal 3 Planning Services: Update Local Coastal Plans (Big Sur, Carmel Area, North County Del Monte Forest) to address ADUs and SB9 provisions, conduct environmental review of draft Vacation Rental Ordinance, develop Agricultural Lands Mitigation & Conservation Plan, draft Telecommunications Ordinance, begin scoping Castroville Community Plan and expedite the processing of cannabis permits. Planning Services will also begin preparing its 6th Cycle Housing Element and establish a local housing trust fund.

Updated Local Coastal Plans (continued update of Big Sur and Carmel Area underway) to address ADUs and SB9 provisions, environmental review of draft Vacation Rental Ordinance underway, developed Agricultural Lands Mitigation Ordinance, Castroville Community Plan update underway, and expedited the processing of cannabis permits and affordable housing projects. 6th Cycle Housing Element drafted and development of Safety Element update and Environmental Justice underway. Additionally completed updates to the Desalination Ordinance and Noise Ordinance.

Goal 4 Permit Center: Establish and measure permit processing targets (wait times) in conjunction with the local construction industry and report results on Department website. Develop and implement an autogenerated customer survey.

Goal not met due to senior manager vacancy. However, this goal is identified to be a priority in FY 2023-24.

Budget Year Goals

Goal 1 Housing Administration: Update the Inclusionary Housing Ordinance, including adoption of a Non-Residential Impact Fee.

Goal 2 Development Services: Address the backlog of Code Compliance Administrative Hearings. Adopt by ordinance the County's transportation analysis methodology in line with State goals pursuant to Senate Bill 743 wherein the State of California Environmental Quality Act (CEQA) of 1970 is amended and codified requiring the criteria for determining the significance of transportation impacts of projects. Prioritize recruitments to fill vacant positions vital to the furtherance of efficiency and customer satisfaction.

Goal 3 Planning Services: Update Local Coastal Plans (Big Sur, Carmel Area, North County, Del Monte Forest) to address ADUs and SB9 provisions, adopt Agricultural Lands Mitigation Ordinance and draft Agricultural Buffer Ordinance. Update Castroville Community Plan, Chualar Community Plan, Sixth Cycle Housing Element, Safety Element, and new Environmental Justice Element. Implement permit processing efficiencies and continue to expedite cannabis permits and affordable housing projects.

Goal 4 Permit Center: Establish and measure permit processing targets (wait times) with the implementation of a new Simple Permit Station in conjunction with the local construction industry and report results on Department website. Develop and implement an autogenerated customer survey.

Pending Issues

Department continues to function at an adequate level through utilization of on-call consultants to address the backlog of planning and building applications. An augmentation for consultant work to complete the environmental review of draft Vacation Rental Ordinances was not included in the Recommended Budget.

Policy Considerations

None.

Appropriation Expenditure Detail

	Prior Year 2021-2022	Adopted Budget 2022-2023	CY Estimate 2022-2023	Requested Budget 2023-2024	Recommended Budget 2023-2024	Recommended Change from Adopted	Fund Code	Budget Unit Code
HCD Administration (HCD001)	2,506,780	3,993,238	4,033,835	4,214,434	4,094,434	101,196	001	8542
Community Development (HCD002)	12,369,463	15,507,128	14,579,000	16,527,086	15,505,040	(2,088)	001	8543
Inclusionary Housing (HCD003)	227,125	120,119	100,342	517,575	517,575	397,456	009	8544
Community Development Reuse (HCD004)	752,396	5,025,684	2,839,130	5,878,083	5,878,083	852,399	013	8545
Community Development Grant (HCD005)	1,750,160	3,857,920	3,054,624	1,236,268	1,236,268	(2,621,652)	013	8546
Castro/Paj HS-A (HCD006)	160,368	809,943	566,000	355,000	355,000	(454,943)	175	8547

Appropriation Expenditure Detail

	Prior Year 2021-2022	Adopted Budget 2022-2023	CY Estimate 2022-2023	Requested Budget 2023-2024	Recommended Budget 2023-2024	Recommended Change from Adopted	Fund Code	Budget Unit Code
East Garrison Developer Reimbursements (HCD008)	11,940	129,000	512,000	135,000	135,000	6,000	182	8549
Fort Ord Habitat Management (HCD009)	188,801	545,625	211,008	253,650	253,650	(291,975)	029	8550
Fort Ord Housing Set-Aside (HCD011)	0	1,811	1,811	0	0	(1,811)	177	8583
East Garrison Housing Set-Aside (HCD012)	0	94	94	0	0	(94)	178	8584
Subtotal	\$17,967,033	\$29,990,562	\$25,897,844	\$29,117,096	\$27,975,050	\$(2,015,512)		

Budget Units

	Prior Year 2021-2022	Adopted Budget 2022-2023	CY Estimate 2022-2023	Requested Budget 2023-2024	Recommended Budget 2023-2024	Recommended Change from Adopted
HCD Administration	\$2,506,780	\$3,993,238	\$4,033,835	\$4,214,434	\$4,094,434	\$101,196
Community Development	\$12,369,463	\$15,507,128	\$14,579,000	\$16,527,086	\$15,505,040	\$(2,088)
Inclusionary Housing	\$227,125	\$120,119	\$100,342	\$517,575	\$517,575	\$397,456
Community Development Reuse	\$752,396	\$5,025,684	\$2,839,130	\$5,878,083	\$5,878,083	\$852,399
Community Development Grant	\$1,750,160	\$3,857,920	\$3,054,624	\$1,236,268	\$1,236,268	\$(2,621,652)
Castro/Paj HS-A	\$160,368	\$809,943	\$566,000	\$355,000	\$355,000	\$(454,943)
Boronda HS-A	—	—	—	—	—	—
East Garrison Developer Reimbursements	\$11,940	\$129,000	\$512,000	\$135,000	\$135,000	\$6,000
Fort Ord Habitat Management	\$188,801	\$545,625	\$211,008	\$253,650	\$253,650	\$(291,975)
Fort Ord Housing Set-Aside	—	\$1,811	\$1,811	—	—	\$(1,811)
East Garrison Housing Set-Aside	—	\$94	\$94	—	—	\$(94)
Subtotal	\$17,967,033	\$29,990,562	\$25,897,844	\$29,117,096	\$27,975,050	\$(2,015,512)

Adopted FY 2022-23 to Recommended FY 2023-24 Positions

Classification Code	Classification Label	Adopted Budget 2021-2022	Adopted Budget 2022-2023	Recommended Budget 2023-2024	Change
11A34	DIRECTOR OF HOUSING AND COMMUNITY DEVELOPMENT	1.00	1.00	1.00	0.00
14C30	MANAGEMENT ANALYST II	5.00	5.00	4.00	(1.00)
14C31	MANAGEMENT ANALYST III	1.00	1.00	1.00	0.00
14G02	MANAGEMENT ANALYST I	1.00	1.00	1.00	0.00
14H30	RMA OMBUDSPERSON	0.00	0.00	1.00	1.00
14K46	PERMIT CENTER MANAGER	0.00	1.00	1.00	0.00
14K47	BUILDING SERVICES MANAGER	0.00	1.00	1.00	0.00
14K50	CHIEF OF PLANNING	1.00	1.00	1.00	0.00
14K51	PRINCIPAL PLANNER	0.00	3.00	2.00	(1.00)
14K51	RMA SERVICES MANAGER	5.00	0.00	0.00	0.00
14M22	HOUSING PROGRAM MANAGER	1.00	1.00	1.00	0.00
20B10	ACCOUNTANT I	1.00	1.00	1.00	0.00
20B95	FINANCE MANAGER I	2.00	2.00	2.00	0.00
30D21	BUILDING INSPECTOR II	5.00	5.00	5.00	0.00
30D22	SENIOR BUILDING INSPECTOR	1.00	1.00	1.00	0.00
30D25	CHIEF OF BUILDING SERVICES	1.00	1.00	1.00	0.00
34P26	CODE COMPLIANCE INSPECTOR II	6.00	8.00	8.00	0.00
34P27	SENIOR CODE COMPLIANCE INSPECTOR	1.00	1.00	1.00	0.00
41A10	ASSISTANT ENGINEER	2.00	2.00	2.00	0.00

Adopted FY 2022-23 to Recommended FY 2023-24 Positions

Classification Code	Classification Label	Adopted Budget 2021-2022	Adopted Budget 2022-2023	Recommended Budget 2023-2024	Change
41A20	CIVIL ENGINEER	1.00	1.00	1.00	0.00
41A22	SENIOR CIVIL ENGINEER	1.00	1.00	1.00	0.00
41B21	BUILDING PLANS EXAMINER	4.00	4.00	4.00	0.00
41C02	WATER RESOURCES HYDROLOGIST	2.00	2.00	2.00	0.00
41C14	ASSOCIATE WATER RESOURCES HYDROLOGIST	1.00	1.00	1.00	0.00
41F11	ASSOCIATE PLANNER	12.00	12.00	12.00	0.00
41F22	SENIOR PLANNER	4.00	4.00	4.00	0.00
41F23	SUPERVISING PLANNER	2.00	2.00	2.00	0.00
41F30	REDEVELOPMENT/HOUSING PROJECT ANALYST I	1.00	1.00	0.00	(1.00)
41F31	REDEVELOPMENT/HOUSING PROJECT ANALYST II	0.00	0.00	1.00	1.00
41F32	REDEVELOPMENT/HOUSING PROJECT ANALYST III	1.00	1.00	1.00	0.00
43A22	ENGINEERING AIDE III	1.00	1.00	1.00	0.00
43A23	ENGINEERING TECHNICIAN	2.00	2.00	2.00	0.00
43B03	WATER RESOURCES TECHNICIAN	1.00	2.00	2.00	0.00
43C10	PERMIT TECHNICIAN I	3.00	3.00	3.00	0.00
43C11	PERMIT TECHNICIAN II	5.00	5.00	5.00	0.00
43C12	PERMIT TECHNICIAN III	1.00	1.00	2.00	1.00
80A31	SECRETARY	2.00	2.00	2.00	0.00
80A32	SENIOR SECRETARY	2.00	2.00	2.00	0.00
80A33	ADMINISTRATIVE SECRETARY	2.00	1.00	1.00	0.00
80A99	ADMINISTRATIVE SECRETARY-CONFIDENTIAL	0.00	1.00	1.00	0.00
80E01	OFFICE ASSISTANT I	1.00	1.00	1.00	0.00
80E21	OFFICE ASSISTANT II	9.00	10.00	10.00	0.00
80E22	OFFICE ASSISTANT III	3.00	3.00	3.00	0.00
80E80	PRINCIPAL OFFICE ASSISTANT	0.00	1.00	1.00	0.00
80E81	SUPERVISING OFFICE ASSISTANT I	1.00	0.00	0.00	0.00
80E82	SUPERVISING OFFICE ASSISTANT II	1.00	1.00	1.00	0.00
80J22	SENIOR ACCOUNT CLERK	1.00	1.00	1.00	0.00
80J30	ACCOUNTING TECHNICIAN	1.00	1.00	1.00	0.00
Total		99.00	103.00	103.00	0.00

Augmentation Requests

Request Code	Request Name	Ranking Type Name	Requested Amount	Requested FTE	Recommended Budget	Recommended FTE
3100-8542-001-AUG03	Housing Housekeys	New Mandated Program/Service w/ General Fund Funding	120,000	-	-	-
3100-8543-001-AUG04	GPU Update	New Mandated Program/Service w/ General Fund Funding	270,906	-	270,906	-
3100-8543-001-AUG05	Code Compliance Inspector II	Request New Position	142,045	1.00	-	-
3100-8543-001-AUG06	Permit Technician III	Request New Position	135,955	1.00	-	-
3100-8543-001-AUG07	Associate Planner	Request New Position	155,468	1.00	-	-
3100-8543-001-AUG08	Associate Planner	Request New Position	155,468	1.00	-	-
3100-8543-001-AUG09	GIS Analyst II	Request New Position	160,308	1.00	-	-
3100-8543-001-AUG10	Business Technology Analyst I	Request New Position	149,152	1.00	-	-
3100-8543-001-AUG11	Vacation Short Term Rentals	New Mandated Program/Service w/ General Fund Funding	123,650	-	-	-
3100-8543-001-AUG12	Chualar Community Plan	New Mandated Program/Service w/ General Fund Funding	50,000	-	50,000	-
Grand Total:			\$1,462,952	6.00	\$320,906	-

Administration

(Budget Unit 8542—Fund 001—Appropriation Unit HCD001)

Use of Funds

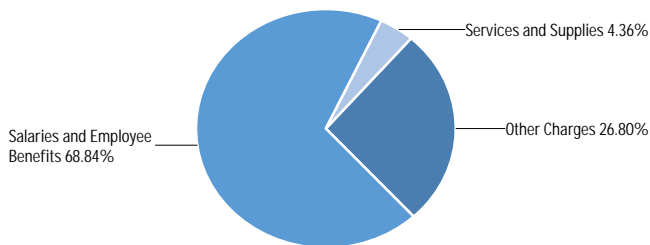

Source of Funds

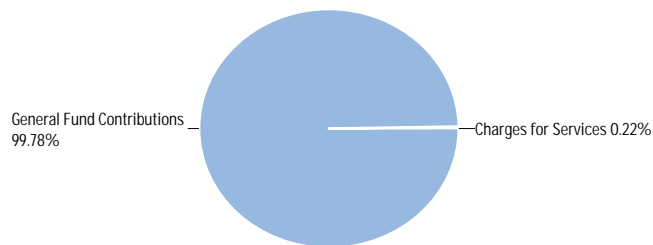

Use of Funds

Expenditures	Prior Year 2021-2022	Adopted Budget 2022-2023	CY Estimate 2022-2023	Requested Budget 2023-2024	Recommended Budget 2023-2024	Recommended Change from Adopted
Salaries and Employee Benefits	\$1,945,343	\$2,509,607	\$2,379,897	\$2,816,512	\$2,816,512	\$306,905
Services and Supplies	\$487,480	\$1,046,409	\$1,020,995	\$298,261	\$178,261	\$(868,148)
Other Charges	\$53,082	\$437,222	\$629,662	\$1,096,380	\$1,096,380	\$659,158
Capital Assets	\$20,876	—	\$3,281	\$3,281	\$3,281	\$3,281
Subtotal	\$2,506,780	\$3,993,238	\$4,033,835	\$4,214,434	\$4,094,434	\$101,196

Source of Funds

Revenues	Prior Year 2021-2022	Adopted Budget 2022-2023	CY Estimate 2022-2023	Requested Budget 2023-2024	Recommended Budget 2023-2024	Recommended Change from Adopted
Charges for Services	—	—	—	\$8,948	\$8,948	\$8,948
Miscellaneous Revenues	\$27	—	—	—	—	—
Subtotal	\$27	—	—	\$8,948	\$8,948	\$8,948
General Fund Contributions	\$2,506,754	\$3,993,238	\$4,033,835	\$4,205,486	\$4,085,486	\$92,248
Total Source of Funds	\$2,506,780	\$3,993,238	\$4,033,835	\$4,214,434	\$4,094,434	\$101,196

Unit Description

The Administrative Unit is responsible for functional activities that support the department and provides departmental executive direction, oversight, centralized administrative and financial staff support. This unit also includes consolidated functions that provide services to support HCD operations including budget, finance and accounting services and secretarial support. The management analyst team oversees contracts and agreements and support special projects, programs, and administrative functions for the department, including former redevelopment, the former Fort Ord and projects in the lower Carmel River area.

This Unit is also responsible for the County's affordable and inclusionary housing programs, community development, homelessness program, and related grants. Other responsibilities include staffing the Housing Advisory Committee, Urban/County Community Development Block Grant Committee, and serves as support for the Health, Housing, and Human Services Committee.

Recommended FY 2023-24 Positions

Class Code	Classification Label	FTE
11A34	DIRECTOR OF HOUSING AND COMMUNITY DEVELOPMENT	1.00
14C30	MANAGEMENT ANALYST II	2.00
14C31	MANAGEMENT ANALYST III	1.00
14G02	MANAGEMENT ANALYST I	1.00
14H30	RMA OMBUDSPERSON	1.00
14M22	HOUSING PROGRAM MANAGER	1.00
20B10	ACCOUNTANT I	1.00
20B95	FINANCE MANAGER I	2.00
41F31	REDEVELOPMENT/HOUSING PROJECT ANALYST II	1.00
41F32	REDEVELOPMENT/HOUSING PROJECT ANALYST III	1.00
80A31	SECRETARY	1.00
80A32	SENIOR SECRETARY	1.00
80A99	ADMINISTRATIVE SECRETARY-CONFIDENTIAL	1.00
80J22	SENIOR ACCOUNT CLERK	1.00
80J30	ACCOUNTING TECHNICIAN	1.00
Total		17.00

Community Development

(Budget Unit 8543—Fund 001—Appropriation Unit HCD002)

Use of Funds

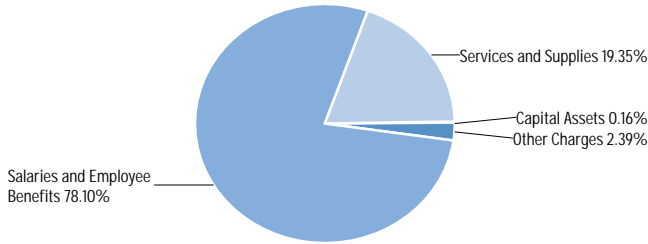

Source of Funds

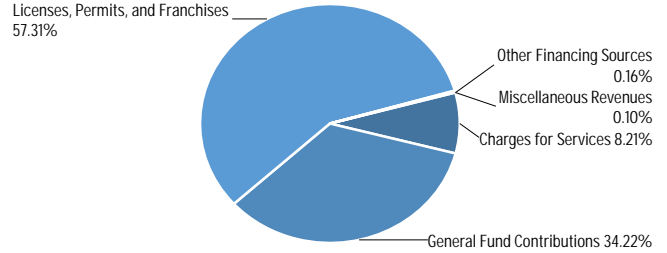

Use of Funds

Expenditures	Prior Year 2021-2022	Adopted Budget 2022-2023	CY Estimate 2022-2023	Requested Budget 2023-2024	Recommended Budget 2023-2024	Recommended Change from Adopted
Salaries and Employee Benefits	\$8,778,157	\$11,321,186	\$10,331,396	\$13,008,346	\$12,109,950	\$788,764
Services and Supplies	\$2,681,853	\$3,349,318	\$3,386,467	\$3,123,694	\$3,000,044	\$(349,274)
Other Charges	\$782,961	\$836,624	\$836,624	\$370,043	\$370,043	\$(466,581)
Capital Assets	\$126,493	—	\$24,513	\$25,003	\$25,003	\$25,003
Subtotal	\$12,369,463	\$15,507,128	\$14,579,000	\$16,527,086	\$15,505,040	\$(2,088)

Source of Funds

Revenues	Prior Year 2021-2022	Adopted Budget 2022-2023	CY Estimate 2022-2023	Requested Budget 2023-2024	Recommended Budget 2023-2024	Recommended Change from Adopted
Licenses, Permits, and Franchises	\$8,051,404	\$7,468,782	\$8,459,426	\$8,885,436	\$8,885,436	\$1,416,654
Intergovernmental Revenues	\$10,044	—	\$20,000	—	—	—
Charges for Services	\$1,358,180	\$1,002,952	\$1,272,904	\$1,273,228	\$1,273,228	\$270,276
Miscellaneous Revenues	\$28,602	\$26,658	\$15,241	\$16,148	\$16,148	\$(10,510)
Other Financing Sources	—	—	—	\$24,851	\$24,851	\$24,851
Subtotal	\$9,448,230	\$8,498,392	\$9,767,571	\$10,199,663	\$10,199,663	\$1,701,271
General Fund Contributions	\$2,921,232	\$7,008,736	\$4,811,429	\$6,327,423	\$5,305,377	\$(1,703,359)
Total Source of Funds	\$12,369,463	\$15,507,128	\$14,579,000	\$16,527,086	\$15,505,040	\$(2,088)

Unit Description

The Community Development Unit consists of the following functions: Permit Center, Building Services, Planning, Engineering and Environmental Services.

The Permit Center provides agency-wide internal and external customer service through its Permit Counter, Call Center, Public Records, and Administrative Support teams. Staff is also responsible for the department website and access to public data.

Building Services issues construction permits, reviews and approves proposed construction documentation and performs inspections of ongoing construction to assure compliance with County and State laws related to building health and safety standards. Building Services includes four programs and coordinates the review and approval of

building permit applications with other related County agencies and 13 fire protection districts. Building Services plan check engineers and technicians review plans and supporting documentation to ensure that building codes and other construction regulations are met. Inspectors also investigate construction work performed without permits, provide technical advice to the public in the field or in the office, and perform routine plan checks as time permits. Code Enforcement responds to and investigates complaints of violations regarding State and County building, zoning, housing and grading policies and help property owners bring their properties into compliance.

Planning is primarily responsible for regulating development activity in the unincorporated areas of the County, preparing and implementing land use policy and regulations, providing information to the public, and reviewing development projects to ensure

compliance with the County’s land use regulations governing planning, building construction and design, subdivisions, and grading and erosion control. In addition, Planning has the responsibility of preparing and reviewing environmental documents for development within the County, processing discretionary land use permits, conducting code enforcement of land use regulations, managing records, and maintaining long-range planning documents including the General Plan, Local Coastal Program, and implementing ordinances. Planning provides staff support to the Planning Commission, Zoning Administrator, Cannabis Committee, Inter-Agency Review (IAR), Airport Land Use Commission (ALUC), Land Use Advisory Committees (LUAC) and Historical Committees.

Engineering reviews major and minor subdivisions, improvement plans, surveys and maps, and processing of final maps and parcel maps in accordance with the Subdivision Map Act, the Land Surveyors Act, and local ordinances. Review includes the review of technical documentation consistent with the California Environmental Quality Act (CEQA) documentation. In addition, Development Services provides the technical review of boundary maps for the Local Agency Formation Commission (LAFCO), the road-naming and house-numbering system, transportation permits for oversize and overweight vehicles traveling in Monterey County and issuance of encroachment permits for public right-of-way.

Environmental Services consolidates development review responsibilities for grading and erosion control. Staff conducts site inspections throughout the construction process to ensure code compliance. The following program elements are required to be developed and/or implemented on an ongoing basis: Construction Site Storm Water Runoff Control Program, and Post-Construction Storm Water Management Program.

Recommended FY 2023-24 Positions

Classification Code	Classification Label	FTE
30D21	BUILDING INSPECTOR II	5.00
30D22	SENIOR BUILDING INSPECTOR	1.00
30D25	CHIEF OF BUILDING SERVICES	1.00
34P26	CODE COMPLIANCE INSPECTOR II	8.00
34P27	SENIOR CODE COMPLIANCE INSPECTOR	1.00
41A10	ASSISTANT ENGINEER	2.00
41A20	CIVIL ENGINEER	1.00
41A22	SENIOR CIVIL ENGINEER	1.00
41B21	BUILDING PLANS EXAMINER	4.00
41C02	WATER RESOURCES HYDROLOGIST	2.00
41C14	ASSOCIATE WATER RESOURCES HYDROLOGIST	1.00
41F11	ASSOCIATE PLANNER	12.00
41F22	SENIOR PLANNER	4.00
41F23	SUPERVISING PLANNER	2.00
43A22	ENGINEERING AIDE III	1.00
43A23	ENGINEERING TECHNICIAN	2.00
43B03	WATER RESOURCES TECHNICIAN	2.00
43C10	PERMIT TECHNICIAN I	3.00
43C11	PERMIT TECHNICIAN II	5.00
43C12	PERMIT TECHNICIAN III	2.00
80A31	SECRETARY	1.00
80A32	SENIOR SECRETARY	1.00
80A33	ADMINISTRATIVE SECRETARY	1.00
80E01	OFFICE ASSISTANT I	1.00
80E21	OFFICE ASSISTANT II	10.00
80E22	OFFICE ASSISTANT III	3.00
80E80	PRINCIPAL OFFICE ASSISTANT	1.00
80E82	SUPERVISING OFFICE ASSISTANT II	1.00
Total		86.00

Recommended FY 2023-24 Positions

Classification Code	Classification Label	FTE
14C30	MANAGEMENT ANALYST II	2.00
14K46	PERMIT CENTER MANAGER	1.00
14K47	BUILDING SERVICES MANAGER	1.00
14K50	CHIEF OF PLANNING	1.00
14K51	PRINCIPAL PLANNER	2.00

Inclusionary Housing

(Budget Unit 8544—Fund 009—Appropriation Unit HCD003)

Use of Funds

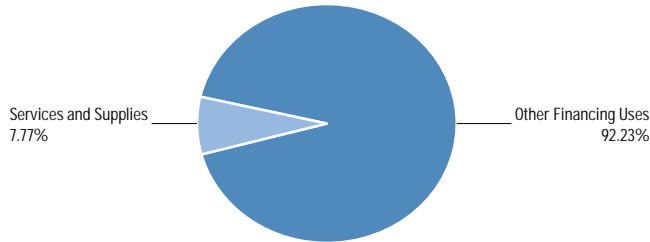

Source of Funds

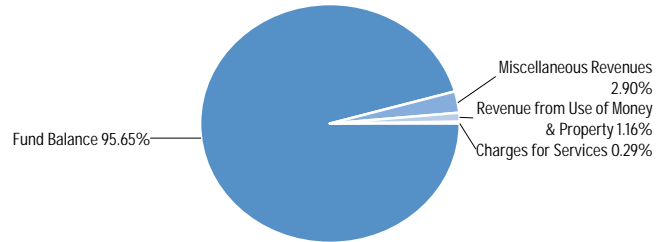

Use of Funds

Expenditures	Prior Year 2021-2022	Adopted Budget 2022-2023	CY Estimate 2022-2023	Requested Budget 2023-2024	Recommended Budget 2023-2024	Recommended Change from Adopted
Services and Supplies	\$227,125	\$95,214	\$134,082	\$40,218	\$40,218	\$(54,996)
Other Charges	—	—	\$(33,740)	—	—	—
Other Financing Uses	—	\$24,905	—	\$477,357	\$477,357	\$452,452
Subtotal	\$227,125	\$120,119	\$100,342	\$517,575	\$517,575	\$397,456

Source of Funds

Revenues	Prior Year 2021-2022	Adopted Budget 2022-2023	CY Estimate 2022-2023	Requested Budget 2023-2024	Recommended Budget 2023-2024	Recommended Change from Adopted
Revenue from Use of Money & Property	\$37,416	\$13,530	\$6,700	\$6,000	\$6,000	\$(7,530)
Intergovernmental Revenues	\$13,500	—	—	—	—	—
Charges for Services	\$5,630	\$5,000	\$1,300	\$1,500	\$1,500	\$(3,500)
Miscellaneous Revenues	\$(328)	\$21,375	\$15,000	\$15,000	\$15,000	\$(6,375)
Other Financing Sources	—	\$62,964	—	—	—	\$(62,964)
Subtotal	\$56,218	\$102,869	\$23,000	\$22,500	\$22,500	\$(80,369)
Fund Balance	\$170,906	\$17,250	\$77,342	\$495,075	\$495,075	\$477,825
Total Source of Funds	\$227,125	\$120,119	\$100,342	\$517,575	\$517,575	\$397,456

Unit Description

The Inclusionary Housing Program was established through an Ordinance adopted by the Board of Supervisors in FY 1979-80. The Ordinance has been amended several times, most recently in 2011. The purpose of the Inclusionary Housing Fund is to facilitate development of housing for low- and moderate- income residents of Monterey County. The Fund is capitalized through payment of in-lieu fees by developers of subdivision projects and repayment of project loans made from inclusionary funds.

Revenue from the funds are distributed to eligible for-profit and non-profit developers to assist with the cost of providing affordable housing to households earning less than 120% of the County median income. The County Housing Advisory Committee reviews

affordable housing proposals. The Fund also supports the cost of administering and monitoring the existing loan portfolio, monitoring inclusionary units, and administering and monitoring all other compliance matters relating to the Inclusionary Housing Ordinance, as well as the land entitlement process. All revenue must be spent in accordance with the requirements of the adopted Inclusionary Housing Ordinance.

The Inclusionary Housing Program provides an opportunity for very low-, low- and moderate-income households to purchase or rent affordable inclusionary units throughout the unincorporated areas of the County of Monterey. Currently, there are approximately 251 owner-occupied inclusionary units and 423 tenant-occupied units in the Inclusionary Housing Program.

Community Development Reuse

(Budget Unit 8545—Fund 013—Appropriation Unit HCD004)

Use of Funds

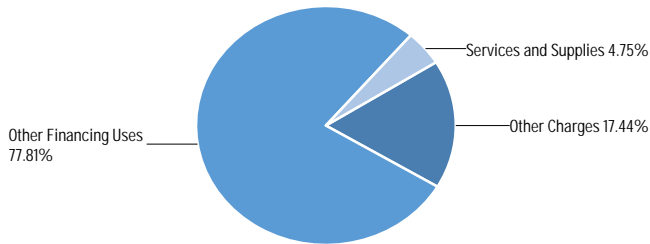

Source of Funds

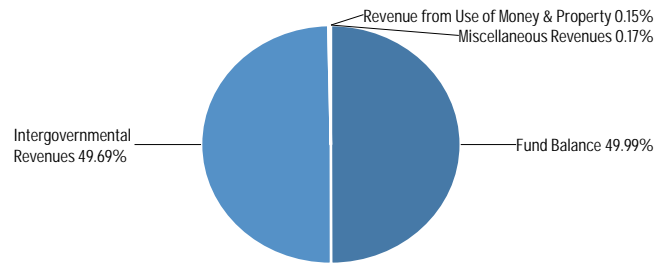

Use of Funds

Expenditures	Prior Year 2021-2022	Adopted Budget 2022-2023	CY Estimate 2022-2023	Requested Budget 2023-2024	Recommended Budget 2023-2024	Recommended Change from Adopted
Services and Supplies	\$752,396	\$2,706,538	\$1,043,939	\$279,212	\$279,212	\$(2,427,326)
Other Charges	—	\$800,749	\$366,260	\$1,025,394	\$1,025,394	\$224,645
Other Financing Uses	—	\$1,518,397	\$1,428,931	\$4,573,477	\$4,573,477	\$3,055,080
Subtotal	\$752,396	\$5,025,684	\$2,839,130	\$5,878,083	\$5,878,083	\$852,399

Source of Funds

Revenues	Prior Year 2021-2022	Adopted Budget 2022-2023	CY Estimate 2022-2023	Requested Budget 2023-2024	Recommended Budget 2023-2024	Recommended Change from Adopted
Revenue from Use of Money & Property	\$116,573	\$28,575	\$84,200	\$9,000	\$9,000	\$(19,575)
Intergovernmental Revenues	\$38,281	\$3,496,005	\$1,407,199	\$2,918,300	\$2,918,300	\$(577,705)
Charges for Services	—	\$71,145	—	\$4,573	\$4,573	\$(66,572)
Miscellaneous Revenues	\$386,671	\$12,065	\$57,000	\$10,000	\$10,000	\$(2,065)
Subtotal	\$541,525	\$3,607,790	\$1,548,399	\$2,941,873	\$2,941,873	\$(665,917)
Fund Balance	\$210,871	\$1,417,894	\$1,290,731	\$2,936,210	\$2,936,210	\$1,518,316
Total Source of Funds	\$752,396	\$5,025,684	\$2,839,130	\$5,878,083	\$5,878,083	\$852,399

Unit Description

This unit provides for the reuse of payments on loans that were originally funded by State Community Development Block Grant (CDBG) and HOME Investment Partnerships (HOME) program funds. Grant funds are loaned to low and very low-income households

for first-time homebuyer down payment assistance activities and to nonprofits for affordable housing projects. All program income must be spent on eligible activities in accordance with State regulations and adopted Program Income Reuse Plans and Guidelines.

Community Development Grant

(Budget Unit 8546—Fund 013—Appropriation Unit HCD005)

Use of Funds

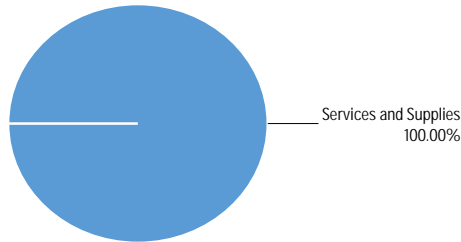

Source of Funds

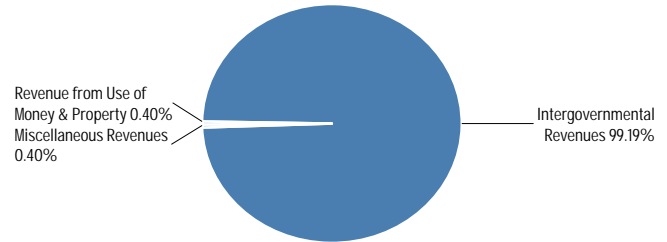

Use of Funds

Expenditures	Prior Year 2021-2022	Adopted Budget 2022-2023	CY Estimate 2022-2023	Requested Budget 2023-2024	Recommended Budget 2023-2024	Recommended Change from Adopted
Services and Supplies	\$1,750,160	\$3,857,920	\$3,054,624	\$1,236,268	\$1,236,268	\$(2,621,652)
Subtotal	\$1,750,160	\$3,857,920	\$3,054,624	\$1,236,268	\$1,236,268	\$(2,621,652)

Source of Funds

Revenues	Prior Year 2021-2022	Adopted Budget 2022-2023	CY Estimate 2022-2023	Requested Budget 2023-2024	Recommended Budget 2023-2024	Recommended Change from Adopted
Revenue from Use of Money & Property	\$62,779	\$16,381	\$30,000	\$5,000	\$5,000	\$(11,381)
Intergovernmental Revenues	\$1,885,239	\$3,817,129	\$3,020,624	\$1,226,268	\$1,226,268	\$(2,590,861)
Miscellaneous Revenues	\$2,854	\$18,445	\$4,000	\$5,000	\$5,000	\$(13,445)
Subtotal	\$1,950,873	\$3,851,955	\$3,054,624	\$1,236,268	\$1,236,268	\$(2,615,687)
Fund Balance	\$(200,712)	\$5,965	—	—	—	\$(5,965)
Total Source of Funds	\$1,750,160	\$3,857,920	\$3,054,624	\$1,236,268	\$1,236,268	\$(2,621,652)

Unit Description

The Community Development Grant unit provides for community and economic development projects funded through federal CDBG, State HOME, and other grant programs and funding sources. This unit

provides funding for public infrastructure, community facilities, housing projects for very low, low, and moderate-income households, and public service programs. Funding must be utilized in accordance with funding source guidelines.

Castroville/Pajaro Housing Set-Aside

(Budget Unit 8547—Fund 175—Appropriation Unit HCD006)

Use of Funds

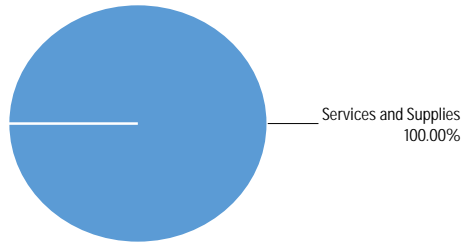

Source of Funds

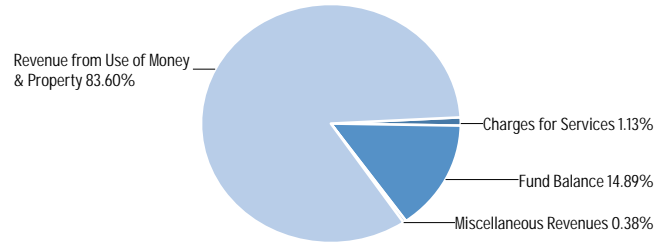

Use of Funds

Expenditures	Prior Year 2021-2022	Adopted Budget 2022-2023	CY Estimate 2022-2023	Requested Budget 2023-2024	Recommended Budget 2023-2024	Recommended Change from Adopted
Services and Supplies	\$160,368	\$559,943	\$566,000	\$355,000	\$355,000	\$(204,943)
Other Financing Uses	—	\$250,000	—	—	—	\$(250,000)
Subtotal	\$160,368	\$809,943	\$566,000	\$355,000	\$355,000	\$(454,943)

Source of Funds

Revenues	Prior Year 2021-2022	Adopted Budget 2022-2023	CY Estimate 2022-2023	Requested Budget 2023-2024	Recommended Budget 2023-2024	Recommended Change from Adopted
Revenue from Use of Money & Property	\$119,466	\$296,700	\$331,300	\$296,790	\$296,790	\$90
Charges for Services	\$16,000	\$4,000	\$8,000	\$4,000	\$4,000	—
Miscellaneous Revenues	\$5,625	\$1,500	\$1,600	\$1,350	\$1,350	\$(150)
Other Financing Sources	\$238,775	—	—	—	—	—
Subtotal	\$379,866	\$302,200	\$340,900	\$302,140	\$302,140	\$(60)
Fund Balance	\$(219,498)	\$507,743	\$225,100	\$52,860	\$52,860	\$(454,883)
Total Source of Funds	\$160,368	\$809,943	\$566,000	\$355,000	\$355,000	\$(454,943)

Unit Description

The Castroville/Pajaro Housing Set-Aside unit was established to facilitate the provision of affordable housing to very low-, low- and moderate-income families within the Castroville/Pajaro Redevelopment Project Area. In accordance with Redevelopment Law, all funds deposited into the Housing Set-Aside Fund were to be

used to increase the supply or improve the condition of very low-, low-, and moderate-income housing. Since the State's dissolution of Redevelopment Agencies and the loss of funds, the County took required action to become the Housing Successor Agency. Any repayment of loans can be used to reinvest in housing.

Boronda Housing Set-Aside

(Budget Unit 8548—Fund 176—Appropriation Unit HCD007)

Use of Funds

Intentionally Left Blank

Source of Funds

Intentionally Left Blank

Source of Funds

Revenues	Prior Year 2021-2022	Adopted Budget 2022-2023	CY Estimate 2022-2023	Requested Budget 2023-2024	Recommended Budget 2023-2024	Recommended Change from Adopted
Revenue from Use of Money & Property	\$11	—	—	—	—	—
Subtotal	\$11	—	—	—	—	—
Fund Balance	\$(11)	—	—	—	—	—
Total Source of Funds	—	—	—	—	—	—

Unit Description

The Boronda Housing Set-Aside provided Redevelopment funding for the provision of affordable housing to low and moderate-income families within the Boronda Redevelopment Project Area. In accordance with State law, all funds deposited into the housing Set-

Aside Fund were used to increase the supply or improve the condition of very low-, low-, and moderate-income housing. Since the State dissolution of Redevelopment Agencies and the loss of funds, the County took required actions to become the Housing Successor Agency. Any repayment of loans can be used to reinvest in housing.

East Garrison Developer Reimbursements

(Budget Unit 8549—Fund 182—Appropriation Unit HCD008)

Use of Funds

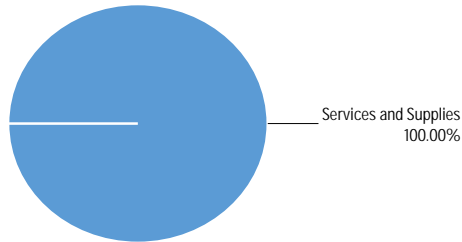

Source of Funds

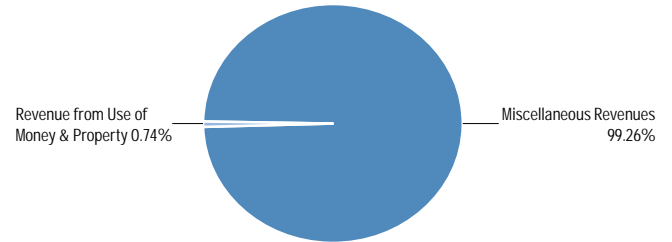

Use of Funds

Expenditures	Prior Year 2021-2022	Adopted Budget 2022-2023	CY Estimate 2022-2023	Requested Budget 2023-2024	Recommended Budget 2023-2024	Recommended Change from Adopted
Services and Supplies	\$11,940	\$129,000	\$512,000	\$135,000	\$135,000	\$6,000
Subtotal	\$11,940	\$129,000	\$512,000	\$135,000	\$135,000	\$6,000

Source of Funds

Revenues	Prior Year 2021-2022	Adopted Budget 2022-2023	CY Estimate 2022-2023	Requested Budget 2023-2024	Recommended Budget 2023-2024	Recommended Change from Adopted
Revenue from Use of Money & Property	\$458	\$1,000	\$1,000	\$1,000	\$1,000	—
Miscellaneous Revenues	\$2,454	\$129,000	\$512,000	\$135,000	\$135,000	\$6,000
Subtotal	\$2,912	\$130,000	\$513,000	\$136,000	\$136,000	\$6,000
Fund Balance	\$9,028	\$(1,000)	\$(1,000)	\$(1,000)	\$(1,000)	—
Total Source of Funds	\$11,940	\$129,000	\$512,000	\$135,000	\$135,000	\$6,000

Unit Description

The East Garrison Developer Reimbursement Unit was created in FY 2013-14 for the purpose of monitoring and accurately allocating County Administration costs, including County Counsel, Economic

Development, and support and oversight, including financial support from the Department of Housing and Community Development. These activities are paid from the Developer's deposits and reimbursements and are expected to be cost neutral to the County.

Habitat Management

(Budget Unit 8550—Fund 029—Appropriation Unit HCD009)

Use of Funds

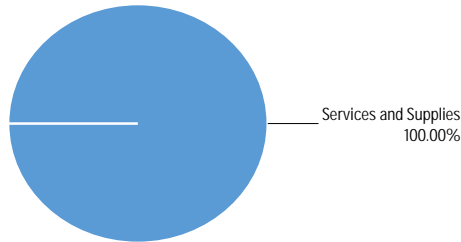

Source of Funds

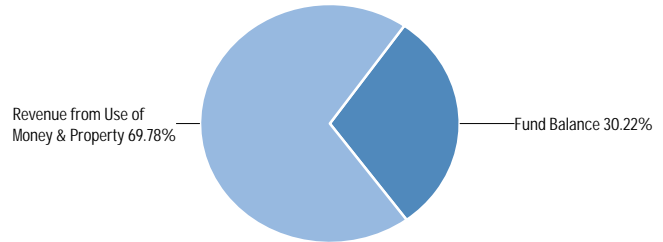

Use of Funds

Expenditures	Prior Year 2021-2022	Adopted Budget 2022-2023	CY Estimate 2022-2023	Requested Budget 2023-2024	Recommended Budget 2023-2024	Recommended Change from Adopted
Salaries and Employee Benefits	\$7,436	—	—	—	—	—
Services and Supplies	\$181,364	\$545,625	\$211,008	\$253,650	\$253,650	\$(291,975)
Subtotal	\$188,801	\$545,625	\$211,008	\$253,650	\$253,650	\$(291,975)

Source of Funds

Revenues	Prior Year 2021-2022	Adopted Budget 2022-2023	CY Estimate 2022-2023	Requested Budget 2023-2024	Recommended Budget 2023-2024	Recommended Change from Adopted
Revenue from Use of Money & Property	\$61,767	\$177,006	\$74,120	\$177,006	\$177,006	—
Charges for Services	\$249,385	—	—	—	—	—
Subtotal	\$311,152	\$177,006	\$74,120	\$177,006	\$177,006	—
Fund Balance	\$(122,351)	\$368,619	\$136,888	\$76,644	\$76,644	\$(291,975)
Total Source of Funds	\$188,801	\$545,625	\$211,008	\$253,650	\$253,650	\$(291,975)

Unit Description

On June 30, 2020, the Fort Ord Reuse Authority (FORA) dissolved, and the County agreed to assume certain responsibilities with associated funding. This Fund was established to implement a habitat

management program for the former Fort Ord lands. Under this program HCD will perform essential habitat management planning activities.

Fort Ord Housing Set-Aside

(Budget Unit 8583—Fund 177—Appropriation Unit HCD011)

Use of Funds	Source of Funds
Intentionally Left Blank	Intentionally Left Blank

Use of Funds							
Expenditures	Prior Year 2021-2022	Adopted Budget 2022-2023	CY Estimate 2022-2023	Requested Budget 2023-2024	Recommended Budget 2023-2024	Recommended Change from Adopted	
Other Financing Uses	—	\$1,811	\$1,811	—	—	—	\$(1,811)
Subtotal	—	\$1,811	\$1,811	—	—	—	\$(1,811)

Source of Funds							
Revenues	Prior Year 2021-2022	Adopted Budget 2022-2023	CY Estimate 2022-2023	Requested Budget 2023-2024	Recommended Budget 2023-2024	Recommended Change from Adopted	
Fund Balance	—	\$1,811	\$1,811	—	—	—	\$(1,811)
Total Source of Funds	—	\$1,811	\$1,811	—	—	—	\$(1,811)

Unit Description

This Fund is closed in FY 2022-23.

East Garrison Housing Set-Aside

(Budget Unit 8584—Fund 178—Appropriation Unit HCD012)

Use of Funds

Source of Funds

Intentionally Left Blank

Intentionally Left Blank

Use of Funds

Expenditures	Prior Year 2021-2022	Adopted Budget 2022-2023	CY Estimate 2022-2023	Requested Budget 2023-2024	Recommended Budget 2023-2024	Recommended Change from Adopted
Other Financing Uses	—	\$94	\$94	—	—	\$(94)
Subtotal	—	\$94	\$94	—	—	\$(94)

Source of Funds

Revenues	Prior Year 2021-2022	Adopted Budget 2022-2023	CY Estimate 2022-2023	Requested Budget 2023-2024	Recommended Budget 2023-2024	Recommended Change from Adopted
Fund Balance	—	\$94	\$94	—	—	\$(94)
Total Source of Funds	—	\$94	\$94	—	—	\$(94)

Unit Description

This Fund is closed in FY 2022-23.

Public Works, Facilities, and Parks

Departmental Overview:

The Public Works, Facilities, and Parks Department (PWFP) provides services to ensure proper and safe development, plan for future needs, manage infrastructure and facilities, and protect natural resources.

Programs and Functions:

PWFP comprises three divisions:

Public Works, Facilities, and Parks, which are responsible for managing and maintaining infrastructure and open space. The Public Works Division consists of Road and Bridge Design; Storm Water and Flood Plain Management, including Special Districts; Road and Bridge Capital Projects; Land Survey, Traffic, and Transportation; and Road and Bridge Maintenance. Public Works manages 1,257 miles of County roads, 175 County maintained bridges, and road appurtenances, such as 29 traffic signals, striping, etc.

The Facilities Division consists of Architectural Services responsible for capital project implementation and project management, including developing the Annual Five-Year Capital Improvement Plan; facility maintenance and grounds crews with a primary purpose of managing over 2.5 million square feet of County-owned facilities; 405,000 square feet of leased building space; real property management oversight of 93 County-owned facilities, 63 leased facilities, 53 County landlord leases and 505 owned parcels; and central services including Fleet Administration, Vehicle Asset Management Program (VAMP), Mail, Courier, and Records Retention.

The Parks Division is responsible for the management and enforcement of 30,672 acres of regional parks and open spaces, comprised of Royal Oaks Park, Manzanita Park, Jacks Peak Park, Toro Park, Travel Camp, San Lorenzo Park, Lake San Antonio (North and South), Lake Nacimiento Resort and Recreation area, Laguna Seca Recreational Area, and the Rifle and Pistol Range. As a result of the dissolution of the Fort Ord Reuse Authority (FORA) in June 2020, the County received an additional 2,980 acres of open space land with habitat management responsibilities.

Departmental Contribution to the County of Monterey Strategic Initiatives:

ADMINISTRATION

Utilize performance measures to monitor key public services and track trends that form organizational improvements, budgeting priorities, and efficiencies.

HEALTH AND HUMAN SERVICES

Provide quality recreational facilities for everyone that visits our parks, lakes, and open space.

INFRASTRUCTURE

Ensure that projects funded in the Countywide Five-Year Capital Improvement Plan (CIP) are completed on schedule and within budget. Continue to update and implement facility management plans and work to increase proactive maintenance. Maintain 1,257 miles of County roads, 175 bridges, and road appurtenances.

PUBLIC SAFETY

Facilitate safe transportation on the County road network. Complete safety improvements, provide secure facilities, and environments for all who utilize County property.



Operating Budget: \$163,093,448
Positions (FTEs): 277.50

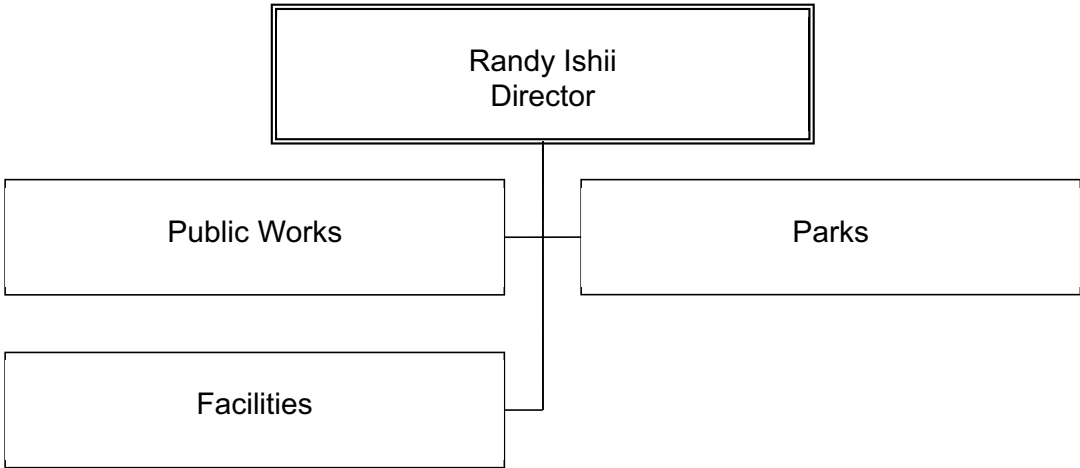

Staffing Trends

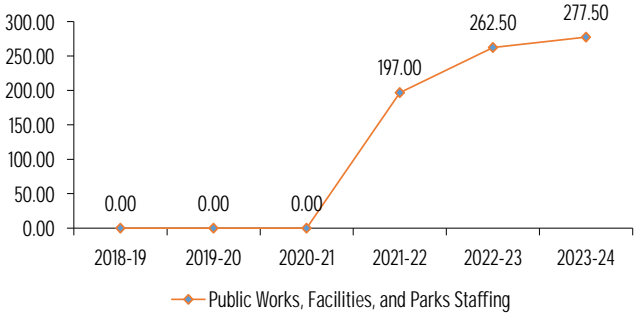

Expenditure/Revenue History (in millions)

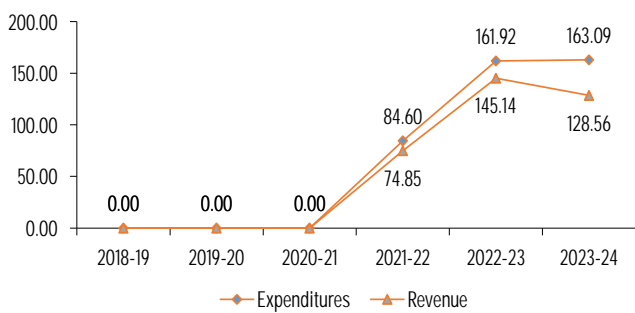

Public Works, Facilities, & Parks (PWFP) utilize these measures to inform operational improvements, assist in developing budgets, and identify additional resources needed to achieve its targets. PWFP partnered with the Transportation Agency for Monterey County (TAMC) on a countywide road condition assessment providing field data.

Key Performance Measures	2020-21 Actual	2021-22 Actual	2022-23 Mid-Year
Percent of County roads (1,257 miles) at Pavement Condition Index rating of 60 or above (FY 2018-19 is modeled data). Target = 50%	16.9%	17.2%	17.7%
Percent of fully funded priority Capital Improvement Program (CIP) projects on schedule and on budget. Target = 100%	71%	74%	80%

Use of Funds

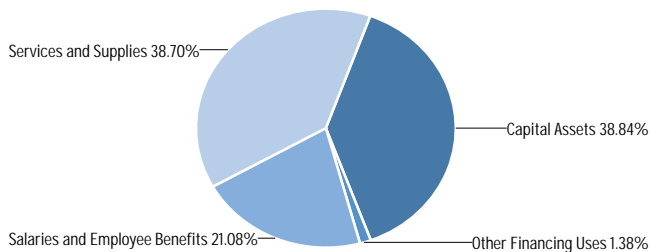

Source of Funds

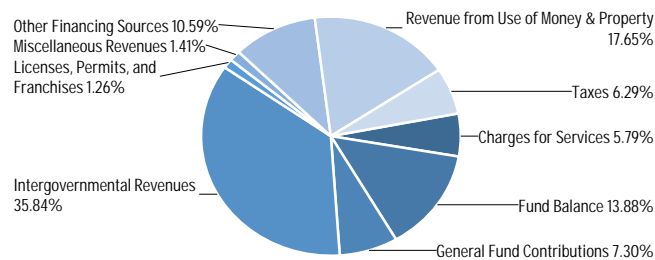

Use of Funds

Expenditures	Prior Year 2021-2022	Adopted Budget 2022-2023	CY Estimate 2022-2023	Requested Budget 2023-2024	Recommended Budget 2023-2024	Recommended Change from Adopted
Salaries and Employee Benefits	\$22,477,138	\$35,974,982	\$30,266,572	\$39,348,265	\$38,124,586	\$2,149,604
Services and Supplies	\$47,897,554	\$61,825,369	\$61,906,611	\$71,938,030	\$69,988,066	\$8,162,697
Other Charges	\$(6,638,658)	\$(17,135,541)	\$(15,429,146)	\$(17,741,269)	\$(17,741,269)	\$(605,728)
Capital Assets	\$20,054,551	\$96,575,076	\$84,391,988	\$151,819,091	\$70,227,970	\$(26,347,106)
Other Financing Uses	\$809,405	\$1,006,142	\$785,766	\$2,494,095	\$2,494,095	\$1,487,953
Subtotal	\$84,599,990	\$178,246,028	\$161,921,791	\$247,858,212	\$163,093,448	\$(15,152,580)

Source of Funds

Revenues	Prior Year 2021-2022	Adopted Budget 2022-2023	CY Estimate 2022-2023	Requested Budget 2023-2024	Recommended Budget 2023-2024	Recommended Change from Adopted
Taxes	\$8,040,018	\$8,540,205	\$9,977,399	\$10,256,072	\$10,256,072	\$1,715,867
Licenses, Permits, and Franchises	\$235,019	\$174,332	\$515,162	\$2,051,200	\$2,051,200	\$1,876,868
Fines, Forfeitures, and Penalties	\$44,174	\$42,178	\$44,312	\$37,000	\$37,000	\$(5,178)
Revenue from Use of Money & Property	\$3,727,883	\$22,283,409	\$19,374,972	\$28,777,394	\$28,777,394	\$6,493,985
Intergovernmental Revenues	\$29,681,181	\$91,491,064	\$66,577,162	\$57,279,229	\$58,439,392	\$(33,051,672)
Charges for Services	\$5,466,093	\$8,792,504	\$9,428,166	\$9,440,194	\$9,440,194	\$647,690
Miscellaneous Revenues	\$1,105,785	\$2,905,532	\$2,913,253	\$2,298,973	\$2,298,973	\$(606,559)
Other Financing Sources	\$26,553,354	\$25,698,292	\$36,309,794	\$16,309,657	\$17,259,657	\$(8,438,635)
Subtotal	\$74,853,506	\$159,927,516	\$145,140,220	\$126,449,719	\$128,559,882	\$(31,367,634)
Fund Balance	\$(6,274,717)	\$1,715,492	\$1,089,390	\$104,225,172	\$22,634,051	\$20,918,559
General Fund Contributions	\$16,021,201	\$16,603,020	\$15,692,181	\$17,183,321	\$11,899,515	\$(4,703,505)
Total Source of Funds	\$84,599,990	\$178,246,028	\$161,921,791	\$247,858,212	\$163,093,448	\$(15,152,580)

Summary of Recommendation

The Recommended Budget for Public Works, Facilities and Parks (PWF) includes appropriations of \$163,093,448 with total expenditures of \$182,813,443, financed with revenues of \$128,559,882, cost plan credits of \$8,216,754, interfund reimbursements of \$5,041,763, intrafund reimbursements of \$6,461,478, a General Fund Contribution (GFC) of \$11,899,515, and the use of \$22,634,051 in fund balance for non-General Fund units. Overall, the Recommended Budget expenditures and revenues decreased due to capital projects nearing completion in FY 2023-24, like the Behavioral Health East Salinas Center, Laguna Seca Start/Finish Bridge and Racetrack Resurfacing, Road Fund projects, and numerous American Rescue Plan Act (ARPA) funded water and sewer infrastructure projects. Some notable expenditure increases

include gas utility and electricity costs and operating costs at the Pajaro County Sanitation District due to rising costs from the City of Watsonville Wastewater Treatment Plant. The Laguna Seca Recreational Area estimates increases in expenditures and revenues in anticipation of increases in raceway patron attendance after capital projects are completed.

The Recommended Budget does not include funding for key augmentations, such as in the facilities services operations for custodial and security at Government Center and Schilling, parking citation management and facilities COVID-19 related expenditures; two positions for Jacks Peak Park and a Park Ranger for North County; two Parks Supervisorial positions to oversee cash handling at Lake San Antonio as a result of a County audit; and one Facilities Real Property Specialist.

The Recommended Budget includes 277.5 positions, an increase of 15.0 from the prior year. The new positions are included in the Recommended Budget with various funding sources; 11 with Road Fund dollars, two transferred from the Human Resource Department with General Fund dollars, and two Park positions funded with ARPA Revenue Loss.

Budget Impacts

Public Works, Facilities and Parks (PWFP) submitted 20 augmentations totaling \$6.8 million. The Recommended Budget includes nine augmentations with \$3.6 million in additional GFC. The requests are categorized into five priority groups: 1) Parks Services, 2) Facilities and Utilities, 3) Pajaro County Sanitation District (PCSD) Shortfall, 4) Parks Salary and Benefit Savings, and 5) Unfunded New Positions.

1) Parks Services.

In FY 2022-23, the Board of Supervisors approved an augmentation request for \$250,000 for playground safety inspections and repair/replacement of playground components. Due to supply-chain and labor issues, Parks could not fully utilize the FY 2022-23 augmentation and is requesting to carry over \$230,000 of the funds to FY 2023-24. This is included in the Recommended Budget and funded with American Rescue Plan Act (ARPA) Revenue Loss.

California SB978 requires law enforcement agencies to conspicuously post all current standards, policies, practices, operating procedures, and education and training materials on their website. The Ranger unit is required to follow SB978. PWFP requested \$50,000 to contract a vendor with experience fulfilling SB978 requirements. This is included in the Recommended Budget and funded with ARPA Revenue Loss.

2) Facilities and Utilities.

One-time funding of \$68,750 is needed to complete case closure documentation and monitoring of the well destruction at the East Laurel Yard Fueling Facility, as required by the Regional Water Quality Control Board, Central Coast Region (Water Board). This budget augmentation is included in the Recommended Budget, funded with ARPA Revenue Loss.

Utility costs for multi-use County facilities and the jail rose significantly this past year. Utility costs are expected to increase by \$1.0 million in FY 2023-24. Cost estimates are based on historical consumption and expenditures adjusted to reflect the increases posted by PG&E and Pacific Summit. Utility cost categories include electricity, gas, water, sewer, and disposal services. The Recommended Budget includes \$794,388 of the \$1.0 million requested, funded with ARPA Revenue Loss.

Unscheduled facilities maintenance is needed for corrective or emergency issues that cannot be foreseen. An augmentation request of \$950,000 is included in the Recommended Budget, funded by Fund 478, sub-fund BIR.

The County is obligated to maintain more than 400,000 square feet of occupied building interior space in a clean and orderly condition. The County does not employ a custodial worker classification to provide necessary service. The County entered into agreements with qualified contractors to provide janitorial service by prescribed schedules and special requests. Non-compliance will expose the County to sanctions or fines for violating the Cal-OSHA code related to cleanliness and

sanitation of employee-occupied areas. The augmentation request for \$950,000 is not included in the Recommended Budget.

PWFP contracts for security services within multi-use occupied County facilities to protect the welfare and safety of occupants, visitors, and real property. Alisal Government Center and Schilling are occupied by several departments that provide critical operations and services, including the Board Chambers for the Board of Supervisors. Both facilities are in the County's most populated city and are accessed by the public for various services. Due to the location of these properties, the Alisal Government Center in downtown Salinas and Schilling in an industrial park adjacent to Hwy 101, they provide a unique security challenge that requires 24/7 security services to help maintain a safe work environment and reduce the risk of personal injury and property loss or damage. To continue security services at Alisal and Schilling, an augmentation request for \$575,000 was submitted but is not included in the Recommended Budget.

Parking citation processing is required to support the issuance of tickets mandated by the California Vehicle Code and the Monterey County Code, which specify County parking regulations and enforcement at County facilities, institutions, and unincorporated areas under the authority of the County Administrative Office. The County has contracted with Data Ticket, Inc to provide services, including management of adjudication, payment plan requests for indigent customers (in accordance with Assembly Bill No. 503) review, and Franchise Tax Board processing for collections. Without funding, the County would be non-compliant with the Monterey County Code and the State of California Vehicle Code. This would additionally result in the loss of parking citation revenue for all departments involved. This augmentation request for \$20,000 to continue contracted services with the outside vendor is not included in the Recommended Budget.

The County is mandated to mitigate fire hazards on County-owned properties due to excessive weed and tree growth, per applicable state and local fire codes. Locations are throughout the County on unimproved parcels, abandoned lanes, Right of Ways, and utility easements. Funding is required to increase remediation capability through contracted services, purchase of equipment and tools, and increased labor costs. The Recommended Budget includes \$150,000 of the \$200,000 requested, funded with ARPA Revenue Loss.

To comply with Federal, State, and local mandates related to reducing COVID-19 transmission in the workplace and decontaminating specified areas in the event of exposure, PWFP requested an augmentation of \$125,000 to supplement the Facilities Division budget to accommodate the additional services and supplies. However, the U.S. national emergency to respond to the COVID-19 pandemic ended on April 10, 2023, as President Biden signed a congressional resolution to bring it to a close after three years. It is uncertain how the County will choose to move forward with the cleaning and sanitation of County Facilities. This augmentation is not included in the Recommended Budget.

3) PCSD Shortfall.

A certain level of maintenance is necessary to ensure the PCSD operates properly to avoid equipment and system failure that could result in sewer spills that would be hazardous to the community. The current level of revenue (including customer sewer charges and a portion of general property tax) is insufficient to meet the annual financial needs of the district. To establish a rate structure that provides fiscal sustainability of the system using the required

Proposition 218 process, staff completed a condition assessment and developed proposed rates based on Board direction. The Proposition 218 process was planned to begin in April 2023; however, February/March storms flooded the community of Pajaro, causing significant damages and displacing residents. The recovery effort will be lengthy, and the Board has postponed the process to increase rates. Staff will bring this back before the Board again next year for consideration. PWFP requested \$1.2 million to subsidize PCSD to cover the increased utility costs from the City of Watsonville Wastewater Treatment Plant. The Recommended Budget includes the subsidy, funded with APRA Revenue Loss.

4) Parks Salary and Benefit Savings.

To submit a balanced baseline budget and operate within budget limitations, but against the Citygate report recommendation, PWFP included salary and benefit savings of \$487,769 in Parks. Carrying vacancies has an adverse impact on services and staff who pick up the workload. To rectify this situation and adhere to the Board's direction to implement Citygate recommendations, PWFP is requesting ongoing General Fund Contribution (GFC), so that all positions can be recruited for and filled. The Recommended Budget does not include the restoration of the \$487,769.

5) Unfunded New Positions.

Eight new General Fund positions were requested by PWFP at the cost of \$1.0 million. Two of the eight positions totaling \$229,964 are approved and recommended. The Recommended Budget includes two Parks Buildings & Grounds Supervisors for Lake San Antonio. The positions are funded by ARPA Revenue Loss. Six positions totaling \$735,910 in costs are not included in the Recommended Budget. These positions were requested to be funded for General Fund programs and are deemed critical for PWFP to render its necessary services to the County. The positions are a Parks Buildings & Grounds Worker II and Parks Services Aide II for Jacks Peak Park, a County Parks Ranger II for North County, two Parks Buildings & Grounds Supervisors for Lake San Antonio, and a Real Property Specialist for Facilities.

Prior Year Accomplishments

Goal 1 Recruit and fill vacant positions of Assistant Engineer, Civil Engineer, and other positions. PWFP is actively working with the Human Resources Department (HRD) to recruit and fill key vacant positions. Recruitments are ongoing and some key positions have been filled. Eight of the nine Assistant Engineer positions are filled. Others, such as the Civil Engineer, remain difficult to fill and retain. Recruitments continue to be a department-wide priority.

Goal 2 Consider salary competitiveness for difficult-to-retain professional classifications and develop a succession plan with Human Resources. Several classification and compensation study requests are pending with HRD. This goal continues to be an ongoing task for the department.

Goal 3 Update the Facility Condition Assessment. As part of the goal to implement a countywide computerized maintenance management system (CMMS), PWFP is taking steps to prepare existing data to determine the resources and information needed to create a facility condition assessment. This information will be used as the CMMS baseline to facilitate planning and maintenance priorities. PWFP filled a key staff position in August 2022 with the primary responsibility of advancing the data needed to launch the CMMS. This effort will begin in FY 2023-24 in tandem with a consultant assisting with the

CMMS's needs assessment and procurement efforts to ensure the most current information is used for the automated system. This goal continues to be an ongoing task for the department.

Goal 4 Complete the Parks Master Plan and Facilities Master Plan. Recruitment is underway to obtain the necessary staff to complete this goal. Outside consulting services will also be needed to complete a comprehensive Parks Master Plan. This goal continues to be an ongoing task for the department.

Goal 5 Identify a Countywide Computerized Maintenance Management System (CMMS) to implement in FY 2023-24. A consultant was hired and began work to conduct a needs assessment and assist PWFP with an evaluation of potential CMMS software packages that would best meet PWFP's needs. This evaluation will be completed in early FY 2023-24 when a preferred software vendor will be identified and a software package acquired. Implementation will then follow.

Goal 6 Install Wi-Fi at San Lorenzo Park. The potential to install Wi-Fi at San Lorenzo Park and other County parks was evaluated but determined to be cost-prohibitive. Parks will continue to research satellite-based internet and Wi-Fi products.

Goal 7 Establish electronic file storage standards. PWFP began consultation with ITD to plan a transition from existing network server electronic file storage to a cloud-based approach using SharePoint. That coordination continues with a goal to complete the transition in FY 2023-24.

Goal 8 Improve public interface platforms and links on the website. PWFP coordinated with ITD, who developed a new structure and theme for the PWFP website. The new website structure has been set up, and PWFP is working on updating and creating new content before going live with the refreshed website. The new website will be available to the public by the end of the 2023 calendar year.

Goal 9 Invest in new critical equipment, including mowers, light-duty trucks, and vessels. New critical equipment, such as mowers, has arrived, and staff is looking forward to using them. Additionally, innovative equipment such as hot trucks has been purchased to improve the quality and efficiency of maintenance practices and customer experience.

Goal 10 Parks to implement an Outer Spatial app for park users, develop a docent program for guided informative tours and an outdoor education program like State Parks, and seek out large-scale events and community gatherings. Parks continues refining and loading GIS and park data into the Outer Spatial app with an anticipated release by summer 2023. Parks is working towards a cooperative Outer Spatial rollout with Monterey Peninsula Regional Parks District. Developing a docent and outdoor education program continues to be an ongoing goal for Parks. As community and event groups recover from COVID impacts, Parks has received increased requests for special events and community gatherings. Parks has numerous first-time events scheduled, such as the Mammoth March at Toro Park and various bike clinics and events at the Fort Ord Travel Camp.

Budget Year Goals

Continue close coordination with Human Resources to fill vacant positions throughout the Department, particularly in Parks, and Public Works Engineering and Maintenance Divisions.

Consider salary competitiveness for difficult-to-retain professional classifications and develop a succession plan with Human Resources.

Complete the needs assessment and evaluation to select a preferred vendor/software for a Computerized Maintenance Management System (CMMS).

Complete developing content for and publish the updated PWFP website.

Complete the transition to a cloud-based electronic file storage system.

Invest in new critical equipment.

Enter into concessionaire agreement for the Laguna Seca Recreational Area.

Create a park user survey that can be accessed electronically via the internet.

Replace outdated signage in parks and create trail designation signage.

Improve marketing for special events at Lake San Antonio.

Redraft the Parks' naming policy to incorporate private-public partnerships and community-funded improvements.

Develop and implement a small engine/equipment replacement program to switch over to electric or battery-operated small equipment.

Transition all central service units (Facilities, Utilities, Fleet, Mail, Courier, & Records Retention) currently in the General Fund to internal service funds.

Pending Issues

Road Condition

PWFP has approximately \$1.6 billion in deferred maintenance costs: Roads (\$700 million), Bridges (\$300 million), Road Appurtenances (\$500 million), Buildings (\$100 million), and Parks (\$15 million). The addition of Measure X and Senate Bill 1 provided new funding for County roads but not enough to impact deferred maintenance significantly. The County's Road conditions are declining and need rehabilitation. The Pavement Condition Index (PCI) (where 0 is a failed condition and 100 is an excellent condition) indicates the Countywide average is 46 (poor). The Board of Supervisors supported pursuing road rehabilitation of local community and residential roads on an accelerated schedule and directed staff to develop a pilot bond program. A smaller bond issuance was pursued, backed by existing Road Fund revenue sources, with a hybrid implementation approach utilizing consultants and contractors and a measured increase in staff levels. Due to inflation, bond issuance costs are high, which has delayed the implementation of this program. Alternative funding options are being considered.

Parks Deferred Maintenance and New Projects

California Parks and Water Bond Act of 2018 (Prop 68) provided both per capita and competitive grant opportunities for Parks. Prop 68 per capita funds are being used for deferred maintenance projects at Toro, Jacks Peak, Lake Nacimiento, and Lake San Antonio. Applications

for both the Rural Recreation and Tourism Program (RRT) and Regional Park Program (RPP) grants were submitted for various projects, such as the Lake San Antonio North Shore Amphitheater, Lake San Antonio South Shore Marina Project, San Lorenzo Park Improvements, and BMX Pumptrack and Skate Park; however, the grant funding was not awarded by the State. Parks will reapply for some of these projects when the next round of funding is released. There is currently no known funding for Building deferred maintenance. The Laguna Seca Recreational Area (LSRA) became part of PWFP as of November 1, 2021, and similar deferred maintenance challenges have been identified. Parks infrastructure and guest serving facilities such as the Lake Nacimiento lodges and Lake San Antonio trailers continue to degrade and are in significant need of repair and replacement. During the FY 2022-23 storm events, additional damage was incurred. Without substantial funding for repairs, some facilities may need to be closed, seriously impacting the user experience, diminishing guest-generated revenue, and increasing maintenance costs.

Fort Ord Land Management

The Fort Ord Reuse Authority (FORA), which served as the regional coordination agency for the reuse and redevelopment of the former Fort Ord, dissolved on June 30, 2020. Over 2,980 acres of former Fort Ord open space and trails were transferred to the County, which PWFP is responsible for maintaining. The Board approved three of the six positions requested in FY 2022-23 to provide law enforcement and maintenance. The positions are being actively recruited but are not yet filled. Without proper staffing levels to maintain trees and vegetation, reduce wildfire fuel, provide trail maintenance, and provide a presence at the properties, the County will continue to receive concerns from the residents, Bureau of Land Management (BLM), California State University at Monterey Bay (CSUMB), surrounding cities and Monterey County Regional Fire District to address issues related to wildfire, illegal use and public safety. Upon its dissolution, several administrative and management responsibilities were absorbed by the Housing and Community Development Department (HCD) and PWFP. These include records retention and paying unpaid contractual obligations. Some or all of FORA's statutory tax increment (35% of tax revenue generated in former Fort Ord) will pass through to the County (38%), Successor Agencies (54%), and Other Taxing Entities (8%). The 38% County share is generating approximately \$275,000 annually. HCD is currently developing the Habitat Management Plans for the former Fort Ord properties, which will help develop an operations and maintenance program.

Disaster Event Recovery

Significant disaster events have occurred over the past seven years. In FY 2016-17, the 2016 Soberanes Fire and 2017 Winter Storms damaged County roadways, lands, and infrastructure, causing an estimated \$61.8 million in damages. In the first quarter of the 2019 calendar year, storm systems caused widespread damage and flooding in Monterey County, with an estimated cost of \$5.2 million; in FY2019-20, the COVID-19 pandemic impacted Monterey County, causing widespread and potentially long-lasting economic impacts. In FY 2020-21, the River Fire, Carmel Fire, and Dolan Fire razed County lands, private properties, and national forests; not only did the burn scars destroy homes and property, but they also subjected them to significant erosion potential. Much of that denuded land led to mudslides to additional private properties and County infrastructure in January 2021. Overall damages reached nearly \$7.9 million. Then beginning in late December 2022 through mid-January 2023, an extended series of atmospheric river winter storm events caused

flooding and damages to roads, bridges, parks, drainage, and infrastructure, resulting in damages of \$16.8 million. The rain continued in March 2023, causing localized flooding in certain communities, including the community of Pajaro. Damages are estimated at over \$24 million. PWWP continues to work on projects related to these events and coordinate with federal and State agencies for reimbursements.

anticipation of a required process under Proposition 218 to adopt increased rates that would provide adequate revenue to continue operating and maintaining the system. The Proposition 218 process was planned to begin in April 2023. However, given the flooding disaster in the community of Pajaro and continuing recovery effort, the Board will consider delaying the possible implementation of increased rates. If that occurs, approximately \$1.6 million will be needed to fund the system during FY 2023-24.

Pajaro County Sanitation District (PCSD)

Service rates for the PCSD have not been increased in nearly 15 years and are no longer sufficient to fund ongoing system operation and maintenance costs. Updated proposed rates were developed in

Policy Considerations

There are no Policy Considerations.

Appropriation Expenditure Detail

	Prior Year 2021-2022	Adopted Budget 2022-2023	CY Estimate 2022-2023	Requested Budget 2023-2024	Recommended Budget 2023-2024	Recommended Change from Adopted	Fund Code	Budget Unit Code
County Disposal Sites (PFP001)	133,172	149,410	128,278	149,359	149,359	(51)	001	8551
Facility Services (PFP054)	3,469,810	2,599,693	3,123,589	4,591,958	2,683,407	83,714	001	8552
Utilities (Oxx)	0	0	0	677	677	677	001	8553
Utilities (PFP055)	2,064,186	1,871,916	2,272,878	3,080,870	2,850,906	978,990	001	8553
Litter Control (PFP002)	413,026	474,287	162,725	485,312	485,312	11,025	001	8554
Special Districts Admin (PFP003)	43,970	59,296	59,296	52,697	52,697	(6,599)	001	8555
Park Operations (PFP058)	6,972,471	7,903,388	7,261,003	8,767,290	7,732,162	(171,226)	001	8556
Stormwater/Floodplain Mgmt (PFP061)	840,929	1,319,710	1,144,135	1,565,253	1,565,253	245,543	001	8557
Roads & Bridges (PFP004)	28,340,024	60,152,499	48,694,683	76,196,989	76,196,989	16,044,490	002	8558
Road & Bridge Maintenance (PFP004)	17,998,671	16,916,500	15,558,932	0	0	(16,916,500)	002	8559
Fish & Game Propagation (PFP059)	39,567	52,147	40,834	51,636	51,636	(511)	006	8560
East Garrison Public Financing Authority (PFP005)	18,892	43,925	38,925	36,125	36,125	(7,800)	180	8561
East Garrison Community Services District (PFP006)	1,815,598	2,010,257	2,035,762	1,997,520	1,997,520	(12,737)	181	8562
Capital Projects (PFP056)	4,105,694	0	0	0	0	0	402	8563
Capital Projects (PFP057)	8,125,334	49,052,709	48,573,533	107,885,205	26,294,084	(22,758,625)	404	8564
Nacimiento Resort/Recreation (PFP060)	3,362,834	4,193,603	3,698,724	3,686,682	3,686,682	(506,921)	452	8565
County Service Areas (PFP007)	16,520	67,205	14,852	106,211	106,211	39,006	051	8566
County Service Areas (PFP008)	20,397	201,221	71,851	200,732	200,732	(489)	052	8566
County Service Areas (PFP009)	140	33,639	0	33,791	33,791	152	053	8566
County Service Areas (PFP010)	179,963	272,345	276,971	300,470	300,470	28,125	056	8566
County Service Areas (PFP011)	28,150	17,447	30,614	18,592	18,592	1,145	057	8566
County Service Areas (PFP012)	1,773	6,650	1,542	4,333	4,333	(2,317)	058	8566
County Service Areas (PFP013)	5,085	23,017	4,254	22,633	22,633	(384)	059	8566
County Service Areas (PFP014)	3,187	65,382	8,160	76,559	76,559	11,177	060	8566
County Service Areas (PFP015)	83,522	8,052	5,265	67,078	67,078	59,026	061	8566
County Service Areas (PFP016)	26,220	66,664	42,234	77,227	77,227	10,563	062	8566
County Service Areas (PFP017)	3,021	20,825	2,182	20,041	20,041	(784)	063	8566
County Service Areas (PFP018)	1,539	8,976	1,854	7,997	7,997	(979)	064	8566
County Service Areas (PFP019)	1,815	11,822	1,849	10,590	10,590	(1,232)	065	8566
County Service Areas (PFP020)	7,082	19,684	5,663	18,855	18,855	(829)	066	8566
County Service Areas (PFP021)	2,704	15,719	5,070	10,515	10,515	(5,204)	067	8566
County Service Areas (PFP022)	703	2,622	2,180	7,781	7,781	5,159	068	8566
County Service Areas (PFP023)	7,336	26,770	6,945	26,203	26,203	(567)	069	8566

Appropriation Expenditure Detail

	Prior Year 2021-2022	Adopted Budget 2022-2023	CY Estimate 2022-2023	Requested Budget 2023-2024	Recommended Budget 2023-2024	Recommended Change from Adopted	Fund Code	Budget Unit Code
County Service Areas (PFP024)	1,573	8,342	2,150	5,824	5,824	(2,518)	070	8566
County Service Areas (PFP025)	1,587	17,266	1,859	15,686	15,686	(1,580)	071	8566
County Service Areas (PFP026)	16,961	62,334	13,900	59,670	59,670	(2,664)	072	8566
County Service Areas (PFP027)	4,058	23,259	13,076	42,119	42,119	18,860	073	8566
County Service Areas (PFP028)	23,794	121,293	26,727	85,360	85,360	(35,933)	074	8566
County Service Areas (PFP029)	67,483	44,963	21,734	23,454	23,454	(21,509)	075	8566
County Service Areas (PFP030)	117,868	34,632	20,019	37,630	37,630	2,998	076	8566
County Service Areas (PFP031)	123,482	1,093,571	90,335	1,303,180	1,303,180	209,609	077	8566
County Service Areas (PFP032)	7,990	63,756	9,116	85,513	85,513	21,757	078	8566
County Service Areas (PFP033)	1,272	70,415	3,654	94,487	94,487	24,072	079	8566
County Service Areas (PFP034)	123,087	13,166	5,220	25,956	25,956	12,790	080	8566
County Service Areas (PFP035)	1,028	11,898	3,599	10,306	10,306	(1,592)	081	8566
County Service Areas (PFP036)	803	67,205	3,694	84,031	84,031	16,826	082	8566
County Service Areas (PFP037)	1,356	56,829	3,609	56,723	56,723	(106)	083	8566
County Service Areas (PFP038)	480	9,524	2,384	9,466	9,466	(58)	084	8566
County Service Areas (PFP039)	2,161	18,025	3,670	15,837	15,837	(2,188)	085	8566
County Service Areas (PFP040)	973	63,622	2,464	66,639	66,639	3,017	086	8566
County Service Areas (PFP041)	28,617	43,708	17,168	51,003	51,003	7,295	087	8566
County Service Areas (PFP042)	5,562	689,788	14,002	715,066	715,066	25,278	088	8566
County Service Areas (PFP043)	691	19,833	1,333	21,146	21,146	1,313	089	8566
County Service Areas (PFP044)	0	288	288	288	288	0	090	8566
County Service Areas (PFP045)	25,060	41,816	33,237	80,955	80,955	39,139	091	8566
County Service Areas (PFP046)	189,114	220,500	198,170	274,485	274,485	53,985	093	8566
County Service Areas (PFP051)	15,699	15,849	15,849	15,924	15,924	75	312	8566
County Sanitation District (PFP047)	1,509,677	912,574	2,099,509	2,933,571	2,933,571	2,020,997	151	8567
County Sanitation District (PFP049)	149,841	205,602	196,169	166,662	166,662	(38,940)	156	8567
County Sanitation District (PFP050)	129,015	341,548	380,978	190,165	190,165	(151,383)	157	8567
County Sanitation District (PFP051)	38,850	0	0	0	0	0	306	8567
County Sanitation District (PFP052)	0	38,250	38,250	38,600	38,600	350	306	8567
Administration (PFP062)	3,878,575	4,036,573	4,064,314	591,517	591,517	(3,445,056)	001	8569
Records Retention (PFP063)	0	(402,499)	(402,498)	(31,660)	(31,660)	370,839	001	8574
Courier (PFP064)	0	(197,053)	(197,052)	87,804	87,804	284,857	001	8575
Mail (PFP064)	0	(104,908)	(104,910)	16,423	16,423	121,331	001	8576
Fleet Administration (PFP065)	0	600,142	605,525	(249,089)	(249,089)	(849,231)	001	8577
Rifle Range (PFP066)	0	229,349	224,935	277,039	277,039	47,690	001	8578
Laguna Seca (PFP067)	0	18,560,643	17,735,369	27,293,894	27,293,894	8,733,251	453	8579
Vehicle Replacement (PFP068)	0	3,546,545	3,499,162	3,805,357	3,805,357	258,812	478	8580
Subtotal	\$84,599,990	\$178,246,028	\$161,921,791	\$247,858,212	\$163,093,448	\$(15,152,580)		

Budget Units

	Prior Year 2021-2022	Adopted Budget 2022-2023	CY Estimate 2022-2023	Requested Budget 2023-2024	Recommended Budget 2023-2024	Recommended Change from Adopted
County Disposal Sites	\$133,172	\$149,410	\$128,278	\$149,359	149,359	\$(51)
Facility Services	\$3,469,810	\$2,599,693	\$3,123,589	\$4,591,958	2,683,407	\$83,714
Utilities	\$2,064,186	\$1,871,916	\$2,272,878	\$3,081,547	2,851,583	\$979,667
Litter Control	\$413,026	\$474,287	\$162,725	\$485,312	485,312	\$11,025
Special Districts Admin	\$43,970	\$59,296	\$59,296	\$52,697	52,697	\$(6,599)
Park Operations	\$6,972,471	\$7,903,388	\$7,261,003	\$8,767,290	7,732,162	\$(171,226)
Stormwater/Floodplain Mgmt	\$840,929	\$1,319,710	\$1,144,135	\$1,565,253	1,565,253	\$245,543
Roads & Bridges	\$28,340,024	\$60,152,499	\$48,694,683	\$76,196,989	76,196,989	\$16,044,490
Road & Bridge Maintenance	\$17,998,671	\$16,916,500	\$15,558,932	—	—	\$(16,916,500)
Fish & Game Propagation	\$39,567	\$52,147	\$40,834	\$51,636	51,636	\$(511)
East Garrison Public Financing Authority	\$18,892	\$43,925	\$38,925	\$36,125	36,125	\$(7,800)
East Garrison Community Services District	\$1,815,598	\$2,010,257	\$2,035,762	\$1,997,520	1,997,520	\$(12,737)
Capital Projects	\$4,105,694	—	—	—	—	—
Capital Projects	\$8,125,334	\$49,052,709	\$48,573,533	\$107,885,205	26,294,084	\$(22,758,625)
Nacimiento Resort/Recreation	\$3,362,834	\$4,193,603	\$3,698,724	\$3,686,682	3,686,682	\$(506,921)
County Service Areas	\$1,149,854	\$3,679,922	\$988,743	\$4,190,356	4,190,356	\$510,434
County Sanitation District Administration	\$1,827,382	\$1,497,974	\$2,714,906	\$3,328,998	3,328,998	\$1,831,024
Records Retention	—	\$(402,499)	\$(402,498)	\$(31,660)	(31,660)	\$370,839
Courier	—	\$(197,053)	\$(197,052)	\$87,804	87,804	\$284,857
Mail	—	\$(104,908)	\$(104,910)	\$16,423	16,423	\$121,331
Fleet Administration	—	\$600,142	\$605,525	\$(249,089)	(249,089)	\$(849,231)
Rifle Range	—	\$229,349	\$224,935	\$277,039	277,039	\$47,690
Laguna Seca	—	\$18,560,643	\$17,735,369	\$27,293,894	27,293,894	\$8,733,251
Vehicle Replacement	—	\$3,546,545	\$3,499,162	\$3,805,357	3,805,357	\$258,812
Subtotal	\$84,599,990	\$178,246,028	\$161,921,791	\$247,858,212	\$163,093,448	\$(15,152,580)

Public Works, Facilities, and Parks

Adopted FY 2022-23 to Recommended FY 2023-24 Positions

Classification Code	Classification Label	Adopted Budget 2021-2022	Adopted Budget 2022-2023	Recommended Budget 2023-2024	Change
11A33	DIRECTOR OF PUBLIC WORKS, FACILITIES AND PARKS	1.00	1.00	1.00	0.00
12C23	ASSISTANT DIRECTOR OF PUBLIC WORKS, FACILITIES AND PARKS	1.00	1.00	1.00	0.00
14A10	PROJECT MANAGER I	1.00	1.00	1.00	0.00
14A11	PROJECT MANAGER II	5.00	5.00	5.00	0.00
14A12	PROJECT MANAGER III	4.00	4.00	4.00	0.00
14B21	ASSOCIATE PERSONNEL ANALYST	0.00	0.00	1.00	1.00
14B32	SENIOR PERSONNEL ANALYST	0.00	0.00	1.00	1.00
14C30	MANAGEMENT ANALYST II	8.00	9.00	8.00	(1.00)
14C31	MANAGEMENT ANALYST III	3.00	4.00	4.00	0.00
14C70	ADMINISTRATIVE SERVICES ASSISTANT	1.00	1.00	1.00	0.00
14C74	REAL PROPERTY SPECIALIST	1.00	1.00	1.00	0.00
14E01	BUYER I	0.00	1.00	1.00	0.00
14G02	MANAGEMENT ANALYST I	0.00	2.00	1.00	(1.00)
14H03	PERSONNEL TECHNICIAN-CONFIDENTIAL	0.00	0.00	1.00	1.00
14H64	FLEET MANAGER	0.00	1.00	1.00	0.00
14K48	CAPITAL IMPROVEMENT MANAGER	0.00	1.00	2.00	1.00
14K51	RMA SERVICES MANAGER	1.00	0.00	0.00	0.00

Adopted FY 2022-23 to Recommended FY 2023-24 Positions

Classification Code	Classification Label	Adopted Budget 2021-2022	Adopted Budget 2022-2023	Recommended Budget 2023-2024	Change
14K63	CHIEF OF FACILITIES	1.00	1.00	1.00	0.00
14K70	CHIEF OF PARKS	1.00	1.00	1.00	0.00
14N05	ADMINISTRATIVE OPERATIONS MANAGER	2.00	3.00	4.00	1.00
16G24	GIS ANALYST II	0.00	1.00	1.00	0.00
20B10	ACCOUNTANT I	1.00	3.00	3.00	0.00
20B11	ACCOUNTANT II	2.00	3.00	3.00	0.00
20B12	ACCOUNTANT III	1.00	2.00	2.00	0.00
20B93	FINANCE MANAGER II	1.00	1.00	1.00	0.00
20B94	FINANCE MANAGER III	1.00	1.00	1.00	0.00
20B95	FINANCE MANAGER I	2.00	2.00	2.00	0.00
30D31	CHIEF OF PUBLIC WORKS	1.00	1.00	1.00	0.00
34X21	GUARD	2.00	2.00	2.00	0.00
41A10	ASSISTANT ENGINEER	8.00	10.00	9.00	(1.00)
41A20	CIVIL ENGINEER	3.00	5.00	4.00	(1.00)
41A22	SENIOR CIVIL ENGINEER	3.00	3.00	3.00	0.00
41A87	CHIEF OF SURVEYS	1.00	1.00	1.00	0.00
41C02	WATER RESOURCES HYDROLOGIST	1.00	1.00	1.00	0.00
41C14	ASSOCIATE WATER RESOURCES HYDROLOGIST	0.00	1.00	1.00	0.00
41C17	SENIOR WATER RESOURCES HYDROLOGIST	1.00	1.00	1.00	0.00
41F85	PARKS PLANNING MANAGER	1.00	1.00	1.00	0.00
43A22	ENGINEERING AIDE III	1.00	0.00	0.00	0.00
43A23	ENGINEERING TECHNICIAN	3.00	6.00	8.00	2.00
43B03	WATER RESOURCES TECHNICIAN	1.00	1.00	1.00	0.00
43L18	COMMUNICATIONS TECHNICIAN III	0.00	1.00	1.00	0.00
43L20	COMMUNICATIONS TECHNICIAN I	0.00	1.00	1.00	0.00
43L42	VEHICLE INSTALLATION SPECIALIST	0.00	0.00	1.00	1.00
65C10	PARKS MUSEUM ASSISTANT	1.00	1.00	1.00	0.00
68A30	RANGE MASTER	0.00	1.00	1.00	0.00
68A41	COUNTY PARK RANGER II	2.00	3.00	3.00	0.00
68A42	COUNTY PARK RANGER III	2.00	2.00	2.00	0.00
68A43	COUNTY PARK RANGER SUPERVISOR	1.00	1.00	1.00	0.00
68C01	PARK SERVICES AIDE I	3.00	3.00	3.00	0.00
68C02	RANGE AIDE	0.00	1.00	1.00	0.00
68C21	PARK SERVICES AIDE II	1.00	2.00	2.00	0.00
68C23	PARK SERVICES AIDE III	1.00	1.00	1.00	0.00
70C20	SENIOR GROUNDSKEEPER	1.00	1.00	1.00	0.00
70C21	GROUNDSKEEPER	4.00	4.00	4.00	0.00
70C80	GROUNDS SUPERVISOR	1.00	1.00	1.00	0.00
70F10	FLEET PARTS COORDINATOR	0.00	1.00	1.00	0.00
70F12	SENIOR FLEET PARTS COORDINATOR	0.00	1.00	1.00	0.00
70F21	COURIER	0.00	5.00	5.00	0.00
70F23	STOREKEEPER	0.00	5.00	5.00	0.00
70F81	SUPERVISING STOREKEEPER	0.00	1.00	1.00	0.00
70N01	OFFICE MAINTENANCE WORKER	2.00	2.00	2.00	0.00
72A23	BUILDING MAINTENANCE WORKER	12.00	12.00	12.00	0.00
72A29	SENIOR BUILDING MAINTENANCE WORKER	2.00	2.00	2.00	0.00
72A81	BUILDING MAINTENANCE SUPERVISOR	3.00	3.00	3.00	0.00
72B31	PARKS BUILDING & GROUNDS WORKER II	9.00	10.00	10.00	0.00
72B32	PARKS BUILDING & GROUNDS WORKER SUPERVISOR	3.00	3.00	5.00	2.00
72B40	PARKS UTILITIES & WATER SYSTEMS SPECIALIST	3.00	3.00	3.00	0.00
72B41	SENIOR PARKS UTILITIES & WATER SYSTEMS SPECIALIST	1.00	1.00	1.00	0.00

Adopted FY 2022-23 to Recommended FY 2023-24 Positions

Classification Code	Classification Label	Adopted Budget 2021-2022	Adopted Budget 2022-2023	Recommended	
				Budget 2023-2024	Change
72C20	MECHANIC I	0.00	2.00	1.00	(1.00)
72C23	MECHANIC II	0.00	11.00	11.00	0.00
72C26	MECHANIC III	0.00	2.00	2.00	0.00
72C82	SUPERVISING MECHANIC	0.00	0.00	1.00	1.00
72C83	FLEET SERVICE WRITER	0.00	1.00	1.00	0.00
74D12	ROAD MAINTENANCE WORKER	19.00	23.00	28.00	5.00
74D13	SENIOR ROAD MAINTENANCE WORKER	8.00	8.00	8.00	0.00
74D81	ASSISTANT ROAD SUPERINTENDENT	4.00	5.00	5.00	0.00
74D83	ROAD SUPERINTENDENT	4.00	4.00	4.00	0.00
74D84	ROAD MAINTENANCE SUPERINTENDENT	1.00	1.00	1.00	0.00
74D85	MAINTENANCE MANAGER	2.00	2.00	2.00	0.00
74E11	BRIDGE MAINTENANCE WORKER	4.00	5.00	6.00	1.00
74E31	SENIOR BRIDGE MAINTENANCE WORKER	1.00	1.00	1.00	0.00
74E80	ASSISTANT BRIDGE SUPERINTENDENT	1.00	1.00	1.00	0.00
74E81	BRIDGE SUPERINTENDENT	1.00	1.00	1.00	0.00
74G21	TREE TRIMMER	2.00	2.00	2.00	0.00
74G22	SENIOR TREE TRIMMER	1.00	1.00	1.00	0.00
74I11	TRAFFIC MAINTENANCE WORKER	4.00	4.00	6.00	2.00
74I25	TRAFFIC MAINTENANCE SUPERINTENDENT	1.00	1.00	1.00	0.00
80A31	SECRETARY	4.00	4.00	4.00	0.00
80A32	SENIOR SECRETARY	2.00	2.00	2.00	0.00
80A33	ADMINISTRATIVE SECRETARY	1.00	1.00	1.00	0.00
80E21	OFFICE ASSISTANT II	4.00	4.00	4.00	0.00
80E22	OFFICE ASSISTANT III	1.00	1.00	1.00	0.00
80E90	MAINTENANCE YARD CLERK	4.00	4.00	4.00	0.00
80E91	MAINTENANCE INVENTORY & YARD CLERK	1.00	1.00	1.00	0.00
80J20	ACCOUNTING CLERICAL SUPERVISOR	1.00	1.00	1.00	0.00
80J21	ACCOUNT CLERK	1.00	0.00	0.00	0.00
80J22	SENIOR ACCOUNT CLERK	6.00	9.00	10.00	1.00
80J30	ACCOUNTING TECHNICIAN	3.00	4.00	4.00	0.00
80O22	MAILROOM CLERK	0.00	0.50	0.50	0.00
80O23	SENIOR MAILROOM CLERK	0.00	1.00	1.00	0.00
Total		197.00	262.50	277.50	15.00

Public Works, Facilities, and Parks

Augmentation Requests

Request Code	Request Name	Ranking Type Name	Requested Amount	Requested FTE	Recommended Budget	Recommended FTE
3200-8552-001-AUG18	Real Property Specialist	Request New Position	188,551	1.00	-	-
3200-8552-001-AUG19	Facilities COVID19 Related	New Mandated Program/Service w/ General Fund Funding	125,000	-	-	-
3200-8552-001-AUG2	Laurel Fueling Facility Groundwater Monitoring Well Closeout	New Mandated Program/Service w/ General Fund Funding	68,750	-	68,750	-
3200-8552-001-AUG5	Facility Unscheduled Maintenance	Status Quo Other	950,000	-	950,000	-
3200-8552-001-AUG6	Custodial Services in Multi Use Facilities	Status Quo Other	950,000	-	-	-
3200-8552-001-AUG7	Security Services at Government Center & Schilling	Status Quo Other	575,000	-	-	-
3200-8552-001-AUG8	Parking Citation Processing	Status Quo Other	20,000	-	-	-

Augmentation Requests

3200-8552-001-AUG9	Fire Fuel Abatement	Status Quo Other	200,000	-	150,000	-
3200-8553-001-AUG3	Utilities for Shared Facilities	Status Quo Other	1,024,352	-	794,388	-
3200-8556-001-AUG1	Parks Playground Inspections & Repairs	Status Quo Other	230,000	-	230,000	-
3200-8556-001-AUG11	Parks Building & Grounds Worker II	Request New Position	98,411	1.00	-	-
3200-8556-001-AUG12	County Park Ranger II	Request New Position	133,488	1.00	-	-
3200-8556-001-AUG13	Park Services Aide II	Request New Position	85,496	1.00	-	-
3200-8556-001-AUG14	Parks Building & Grounds Worker Supervisor	Request New Position	114,982	1.00	114,982	1.00
3200-8556-001-AUG15	Parks Building & Grounds Worker Supervisor	Request New Position	114,982	1.00	114,982	1.00
3200-8556-001-AUG16	Parks Building & Grounds Worker Supervisor	Request New Position	114,982	1.00	-	-
3200-8556-001-AUG17	Parks Building & Grounds Worker Supervisor	Request New Position	114,982	1.00	-	-
3200-8556-001-AUG20	Salary & Benefit Savings Parks	Status Quo Other	487,769	-	-	-
3200-8556-001-AUG4	Park Ranger Policy, Procedures & Training Manual	New Mandated Program/Service w/ General Fund Funding	50,000	-	50,000	-
3200-8567-151-AUG10	Pajaro Sanitation System Operations & Maintenance	Contribution to Other Funds	1,160,163	-	1,160,163	-
Grand Total:			\$6,806,908	8.00	\$3,633,265	2.00

County Disposal Sites

(Budget Unit 8551—Fund 001—Appropriation Unit PFP001)

Use of Funds

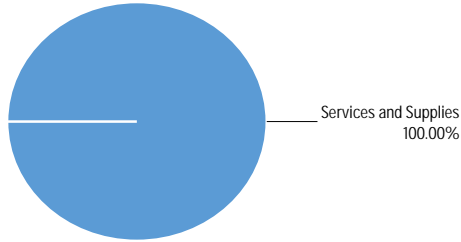

Source of Funds

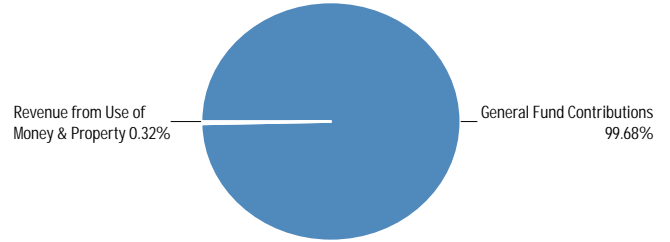

Use of Funds

Expenditures	Prior Year 2021-2022	Adopted Budget 2022-2023	CY Estimate 2022-2023	Requested Budget 2023-2024	Recommended Budget 2023-2024	Recommended Change from Adopted
Services and Supplies	\$133,172	\$149,410	\$128,278	\$149,359	\$149,359	\$(51)
Subtotal	\$133,172	\$149,410	\$128,278	\$149,359	\$149,359	\$(51)

Source of Funds

Revenues	Prior Year 2021-2022	Adopted Budget 2022-2023	CY Estimate 2022-2023	Requested Budget 2023-2024	Recommended Budget 2023-2024	Recommended Change from Adopted
Revenue from Use of Money & Property	—	\$425	\$475	\$475	\$475	\$50
Subtotal	—	\$425	\$475	\$475	\$475	\$50
General Fund Contributions	\$133,172	\$148,985	\$127,803	\$148,884	\$148,884	\$(101)
Total Source of Funds	\$133,172	\$149,410	\$128,278	\$149,359	\$149,359	\$(51)

Unit Description

The County Disposal Site (CDS) Program provides for the administration and inspection of two transfer stations and 12 closed

landfill disposal sites. Three of the landfills (Bradley, North Shore Lake San Antonio and San Ardo) require annual inspections and wet weather preparedness measures.

Facilities Maintenance

(Budget Unit 8552—Fund 001—Appropriation Unit PFP054)

Use of Funds

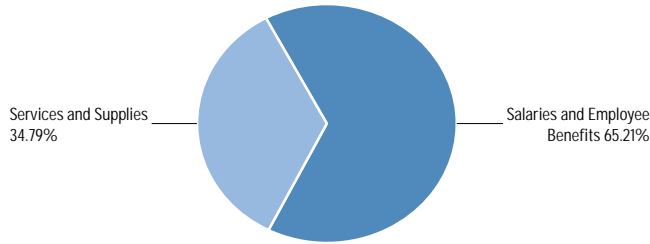

Source of Funds

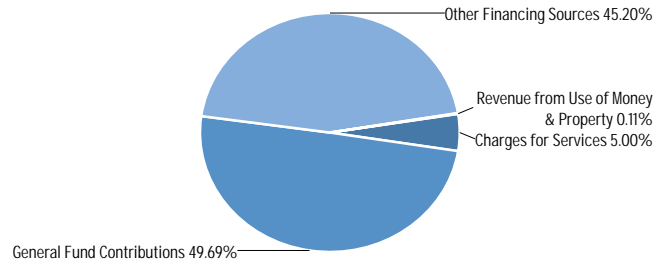

Use of Funds

Expenditures	Prior Year 2021-2022	Adopted Budget 2022-2023	CY Estimate 2022-2023	Requested Budget 2023-2024	Recommended Budget 2023-2024	Recommended Change from Adopted
Salaries and Employee Benefits	\$4,762,456	\$5,650,767	\$5,154,246	\$6,246,759	\$6,058,208	\$407,441
Services and Supplies	\$4,869,093	\$4,589,141	\$5,160,806	\$4,951,430	\$3,231,430	\$(1,357,711)
Other Charges	\$(6,177,394)	\$(7,640,215)	\$(7,285,188)	\$(6,606,231)	\$(6,606,231)	\$1,033,984
Capital Assets	\$15,655	—	\$93,725	—	—	—
Subtotal	\$3,469,810	\$2,599,693	\$3,123,589	\$4,591,958	\$2,683,407	\$83,714

Source of Funds

Revenues	Prior Year 2021-2022	Adopted Budget 2022-2023	CY Estimate 2022-2023	Requested Budget 2023-2024	Recommended Budget 2023-2024	Recommended Change from Adopted
Fines, Forfeitures, and Penalties	\$1,664	\$1,500	\$1,500	\$1,500	\$1,500	—
Revenue from Use of Money & Property	\$5,324	\$257,692	\$3,000	\$3,000	\$3,000	\$(254,692)
Charges for Services	\$140,757	\$133,990	\$133,990	\$133,990	\$133,990	—
Miscellaneous Revenues	\$1,543	—	\$106	—	—	—
Other Financing Sources	\$292,441	—	\$708,484	\$262,180	\$1,212,180	\$1,212,180
Subtotal	\$441,729	\$393,182	\$847,080	\$400,670	\$1,350,670	\$957,488
General Fund Contributions	\$3,028,081	\$2,206,511	\$2,276,509	\$4,191,288	\$1,332,737	\$(873,774)
Total Source of Funds	\$3,469,810	\$2,599,693	\$3,123,589	\$4,591,958	\$2,683,407	\$83,714

Unit Description

The Facilities Maintenance Unit is responsible for operation and maintenance of County buildings as well as grounds maintenance and landscaping on County-owned multi-department facilities, the Public Safety Building, and various parcels outside road rights-of-way. Coverage includes building equipment, such as auxiliary power generators, infrastructure including utility services, and building control functions for heating, ventilation, and air conditioning systems. Facilities administers ongoing programs affecting building and occupancy conditions such as security, parking, code compliance related to occupancy, environmental conditions, and the Americans with Disabilities Act (ADA) Transition Plan. This Unit also provides maintenance to designated areas of the Monterey and King City Courthouses based on percentages specified in Joint Occupancy

Agreements between the County and State of California Administrative Office of the Court (AOC). The County receives reimbursement from the AOC for associated costs in accordance with terms specified in the agreements.

Facilities also provides Architectural and Property Management services. Architectural Services staff provides project management for new construction, major renovation and facility maintenance and repair projects funded by the Facility Master Plan Projects Fund 404, and projects directly funded by County departments. Property Management staff manages real property related to 93 owned facilities, 63 County as tenant leases, 53 County as landlord leases, and 505 owned parcels totaling more than 33,000 acres. This includes management of acquisition, sales, leases, and records affecting properties.

Recommended FY 2023-24 Positions

Classification Code	Classification Label	FTE
14A11	PROJECT MANAGER II	3.00
14A12	PROJECT MANAGER III	1.00
14C30	MANAGEMENT ANALYST II	1.00
14C31	MANAGEMENT ANALYST III	1.00
14C74	REAL PROPERTY SPECIALIST	1.00
14K48	CAPITAL IMPROVEMENT MANAGER	1.00
14K63	CHIEF OF FACILITIES	1.00
14N05	ADMINISTRATIVE OPERATIONS MANAGER	1.00
20B95	FINANCE MANAGER I	1.00
70C20	SENIOR GROUNDSKEEPER	1.00
70C21	GROUNDSKEEPER	4.00
70C80	GROUNDS SUPERVISOR	1.00

Recommended FY 2023-24 Positions

Classification Code	Classification Label	FTE
70N01	OFFICE MAINTENANCE WORKER	2.00
72A23	BUILDING MAINTENANCE WORKER	12.00
72A29	SENIOR BUILDING MAINTENANCE WORKER	2.00
72A81	BUILDING MAINTENANCE SUPERVISOR	3.00
74D85	MAINTENANCE MANAGER	1.00
80A31	SECRETARY	1.00
80A33	ADMINISTRATIVE SECRETARY	1.00
80E21	OFFICE ASSISTANT II	2.00
80J22	SENIOR ACCOUNT CLERK	1.00
80J30	ACCOUNTING TECHNICIAN	1.00
Total		43.00

Utilities

(Budget Unit 8553—Fund 001—Appropriation Unit PFP055)

Use of Funds

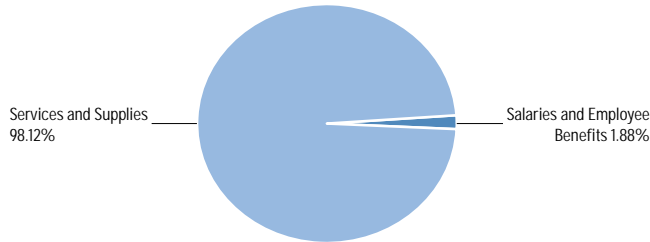

Source of Funds

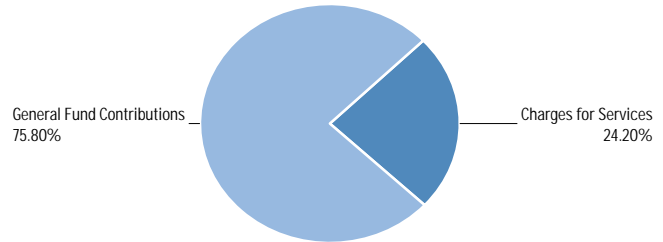

Use of Funds

Expenditures	Prior Year 2021-2022	Adopted Budget 2022-2023	CY Estimate 2022-2023	Requested Budget 2023-2024	Recommended Budget 2023-2024	Recommended Change from Adopted
Salaries and Employee Benefits	—	\$98,459	\$96,655	\$100,974	\$100,974	\$2,515
Services and Supplies	\$4,375,350	\$4,367,485	\$4,770,251	\$5,511,970	\$5,282,006	\$914,521
Other Charges	\$(2,311,164)	\$(2,594,028)	\$(2,594,028)	\$(2,531,397)	\$(2,531,397)	\$62,631
Subtotal	\$2,064,186	\$1,871,916	\$2,272,878	\$3,081,547	\$2,851,583	\$979,667

Source of Funds

Revenues	Prior Year 2021-2022	Adopted Budget 2022-2023	CY Estimate 2022-2023	Requested Budget 2023-2024	Recommended Budget 2023-2024	Recommended Change from Adopted
Charges for Services	\$172,729	\$561,290	\$668,528	\$689,425	\$689,425	\$128,135
Miscellaneous Revenues	\$1,944	\$2,169	\$2,169	\$2,169	\$2,169	—
Subtotal	\$174,673	\$563,459	\$670,697	\$691,594	\$691,594	\$128,135
General Fund Contributions	\$1,889,513	\$1,308,457	\$1,602,181	\$2,389,953	\$2,159,989	\$851,532
Total Source of Funds	\$2,064,186	\$1,871,916	\$2,272,878	\$3,081,547	\$2,851,583	\$979,667

Unit Description

The Utilities Unit accumulates costs associated with water, garbage, sewer, alarm lines, fire protection, gas, and electric for all shared County facilities. In FY 2011-12, the negotiated quarterly County Facility Payments (CFPs) for the utilities associated with the Monterey Courthouse, King City Courthouse, and the North Wing of the Salinas Courthouse moved to the Trial Courts budget under the purview of the County Administrative Office. Separate from the CFPs, the County provides utilities for the common areas within the Monterey and King City Courhouses and until separate metering is

installed the County incurs 100% of the electricity, natural gas, water, and sewer for the North Wing of the Salinas Courthouse. The County is reimbursed for these expenditures based on percentages agreed to in the Joint Occupancy agreements.

Recommended FY 2023-24 Positions

Classification Code	Classification Label	FTE
80J22	SENIOR ACCOUNT CLERK	1.00
Total		1.00

Litter Control

(Budget Unit 8554—Fund 001—Appropriation Unit PFP002)

Use of Funds

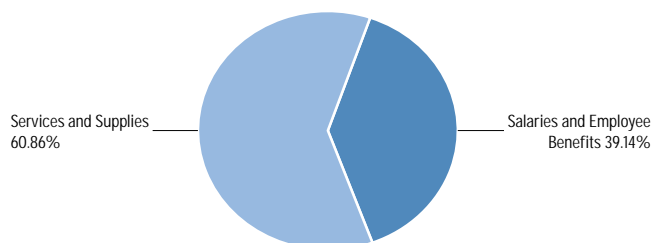

Source of Funds

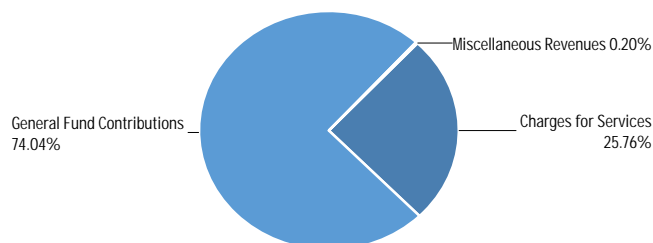

Use of Funds

Expenditures	Prior Year 2021-2022	Adopted Budget 2022-2023	CY Estimate 2022-2023	Requested Budget 2023-2024	Recommended Budget 2023-2024	Recommended Change from Adopted
Salaries and Employee Benefits	\$112,348	\$199,427	\$181,000	\$195,580	\$195,580	\$(3,847)
Services and Supplies	\$367,835	\$314,367	\$206,854	\$304,108	\$304,108	\$(10,259)
Other Charges	\$(67,157)	\$(39,507)	\$(225,129)	\$(14,376)	\$(14,376)	\$25,131
Subtotal	\$413,026	\$474,287	\$162,725	\$485,312	\$485,312	\$11,025

Source of Funds

Revenues	Prior Year 2021-2022	Adopted Budget 2022-2023	CY Estimate 2022-2023	Requested Budget 2023-2024	Recommended Budget 2023-2024	Recommended Change from Adopted
Charges for Services	\$138,093	\$125,000	\$143,166	\$125,000	\$125,000	—
Miscellaneous Revenues	\$651	\$1,030	\$979	\$979	\$979	\$(51)
Other Financing Sources	\$1,525	—	\$1,275	—	—	—
Subtotal	\$140,269	\$126,030	\$145,420	\$125,979	\$125,979	\$(51)
General Fund Contributions	\$272,757	\$348,257	\$17,305	\$359,333	\$359,333	\$11,076
Total Source of Funds	\$413,026	\$474,287	\$162,725	\$485,312	\$485,312	\$11,025

Unit Description

Litter Control provides for the collection and disposal of litter, debris, and hazardous material on County maintained roads and County roads rights-of-way under the jurisdiction of the Board of Supervisors. Litter clean-up from County roads and rights-of-way is a seven-day a week operation staffed by two County employed Litter Guards. The Litter Abatement Program, established in FY 2019-20, is a partnership between Public Works, Facilities and Parks, and waste authorities, Salinas Valley Solid Waste Authority (SVSWA) and

Monterey Regional Waste Management District (MRWMD), and contractor(s) with multiple components. The Litter Abatement Program removes illegal dumping of household, commercial, and industrial waste on County roads and public lands.

Recommended FY 2023-24 Positions

Classification Code	Classification Label	FTE
34X21	GUARD	2.00
Total		2.00

Special Districts Administration

(Budget Unit 8555—Fund 001—Appropriation Unit PFP003)

Use of Funds

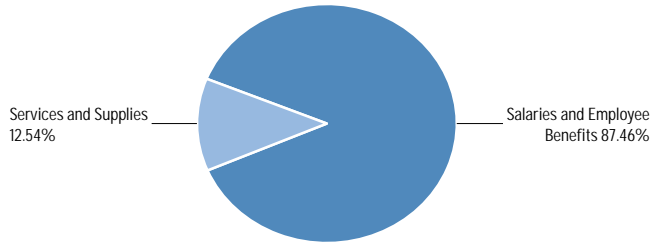

Source of Funds

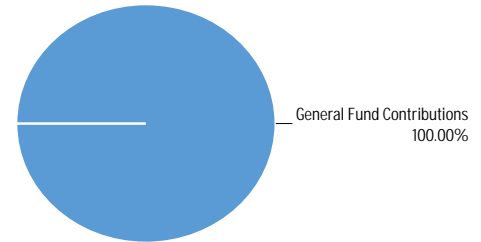

Use of Funds

Expenditures	Prior Year 2021-2022	Adopted Budget 2022-2023	CY Estimate 2022-2023	Requested Budget 2023-2024	Recommended Budget 2023-2024	Recommended Change from Adopted
Salaries and Employee Benefits	\$415,138	\$674,649	\$631,898	\$581,519	\$581,519	\$(93,130)
Services and Supplies	\$69,688	\$73,362	\$40,178	\$83,402	\$83,402	\$10,040
Other Charges	\$(440,856)	\$(688,715)	\$(612,925)	\$(612,369)	\$(612,369)	\$76,346
Capital Assets	—	—	\$145	\$145	\$145	\$145
Subtotal	\$43,970	\$59,296	\$59,296	\$52,697	\$52,697	\$(6,599)

Source of Funds

Revenues	Prior Year 2021-2022	Adopted Budget 2022-2023	CY Estimate 2022-2023	Requested Budget 2023-2024	Recommended Budget 2023-2024	Recommended Change from Adopted
General Fund Contributions	\$43,970	\$59,296	\$59,296	\$52,697	\$52,697	\$(6,599)
Total Source of Funds	\$43,970	\$59,296	\$59,296	\$52,697	\$52,697	\$(6,599)

Unit Description

Special Districts Administration is responsible for the management and oversight of the County's services districts, sanitation districts and closed landfills.

Recommended FY 2023-24 Positions

Classification Code	Classification Label	FTE
14A10	PROJECT MANAGER I	1.00
14C31	MANAGEMENT ANALYST III	1.00
41A20	CIVIL ENGINEER	1.00
Total		3.00

Park Operations

(Budget Unit 8556—Fund 001—Appropriation Unit PFP058)

Use of Funds

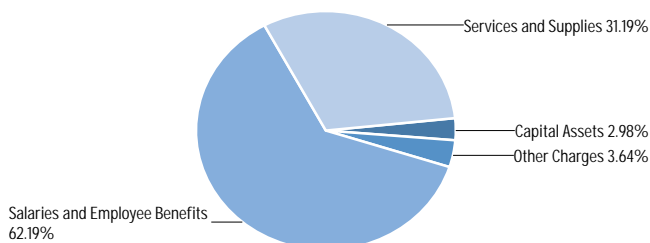

Source of Funds

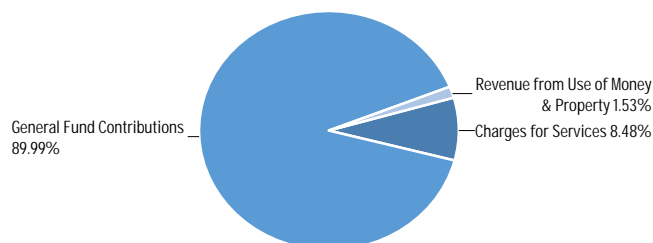

Use of Funds

Expenditures	Prior Year 2021-2022	Adopted Budget 2022-2023	CY Estimate 2022-2023	Requested Budget 2023-2024	Recommended Budget 2023-2024	Recommended Change from Adopted
Salaries and Employee Benefits	\$3,655,099	\$5,186,108	\$4,295,639	\$5,843,957	\$4,808,829	\$(377,279)
Services and Supplies	\$2,115,999	\$1,992,998	\$1,901,447	\$2,411,749	\$2,411,749	\$418,751
Other Charges	\$1,012,605	\$441,463	\$780,848	\$281,334	\$281,334	\$(160,129)
Capital Assets	\$188,768	\$282,819	\$283,069	\$230,250	\$230,250	\$(52,569)
Subtotal	\$6,972,471	\$7,903,388	\$7,261,003	\$8,767,290	\$7,732,162	\$(171,226)

Source of Funds

Revenues	Prior Year 2021-2022	Adopted Budget 2022-2023	CY Estimate 2022-2023	Requested Budget 2023-2024	Recommended Budget 2023-2024	Recommended Change from Adopted
Fines, Forfeitures, and Penalties	\$3,850	\$2,464	\$1,705	\$1,752	\$1,752	\$(712)
Revenue from Use of Money & Property	\$193,117	\$121,378	\$121,378	\$118,138	\$118,138	\$(3,240)
Intergovernmental Revenues	\$124,973	—	—	—	—	—
Charges for Services	\$689,796	\$483,524	\$627,822	\$655,283	\$655,283	\$171,759
Miscellaneous Revenues	\$806	—	\$12,780	\$408	\$408	\$408
Other Financing Sources	\$25,546	\$14,200	\$15,725	\$5,101	\$5,101	\$(9,099)
Subtotal	\$1,038,087	\$621,566	\$779,410	\$780,682	\$780,682	\$159,116
General Fund Contributions	\$5,934,384	\$7,281,822	\$6,481,593	\$7,986,608	\$6,951,480	\$(330,342)
Total Source of Funds	\$6,972,471	\$7,903,388	\$7,261,003	\$8,767,290	\$7,732,162	\$(171,226)

Unit Description

Monterey County Parks were established to protect and preserve the natural, historic, cultural, and recreational resources in the community. The Monterey County PWF-Parks operates and maintains a system of County parks.

The County Parks System enriches the local community by providing an assortment of outdoor and recreational activities, while boosting local tourism and economic activity. Both residents and visitors value parks for access to outdoor spaces to play and be active, exercise and

participate in group sports and experience and discover the natural environment.

Children, teens, adults, seniors, families, businesses, and community organizations benefit from the wide range of park amenities, open spaces, trails, sports fields and playing courts, playgrounds, facilities, and associated programs. One of the primary goals is to provide, enhance and maintain opportunities for public enjoyment, inspiration, education, healthful living, personal development, and cultural enrichment to make lives and communities better now and in the future.

Recommended FY 2023-24 Positions

Classification Code	Classification Label	FTE
14K70	CHIEF OF PARKS	1.00
14N05	ADMINISTRATIVE OPERATIONS MANAGER	2.00
20B12	ACCOUNTANT III	1.00
41F85	PARKS PLANNING MANAGER	1.00
65C10	PARKS MUSEUM ASSISTANT	1.00
68A41	COUNTY PARK RANGER II	3.00
68A42	COUNTY PARK RANGER III	2.00
68A43	COUNTY PARK RANGER SUPERVISOR	1.00
68C01	PARK SERVICES AIDE I	3.00
68C21	PARK SERVICES AIDE II	2.00
68C23	PARK SERVICES AIDE III	1.00

Recommended FY 2023-24 Positions

Classification Code	Classification Label	FTE
72B31	PARKS BUILDING & GROUNDS WORKER II	10.00
72B32	PARKS BUILDING & GROUNDS WORKER SUPERVISOR	5.00
72B40	PARKS UTILITIES & WATER SYSTEMS SPECIALIST	3.00
72B41	SENIOR PARKS UTILITIES & WATER SYSTEMS SPECIALIST	1.00
80A31	SECRETARY	1.00
80A32	SENIOR SECRETARY	1.00
80E22	OFFICE ASSISTANT III	1.00
80J22	SENIOR ACCOUNT CLERK	1.00
	Total	41.00

Stormwater Floodplain Management

(Budget Unit 8557—Fund 001—Appropriation Unit PFP061)

Use of Funds

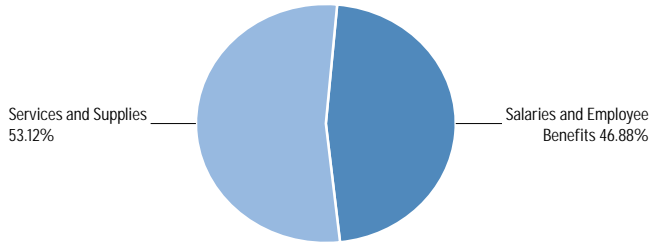

Source of Funds

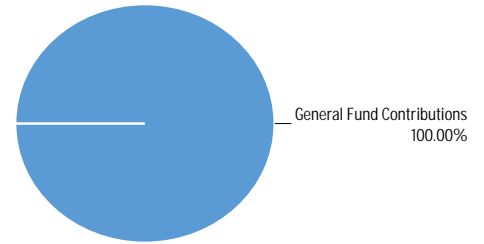

Use of Funds

Expenditures	Prior Year 2021-2022	Adopted Budget 2022-2023	CY Estimate 2022-2023	Requested Budget 2023-2024	Recommended Budget 2023-2024	Recommended Change from Adopted
Salaries and Employee Benefits	\$481,408	\$703,378	\$536,742	\$745,299	\$745,299	\$41,921
Services and Supplies	\$442,688	\$490,381	\$603,521	\$844,621	\$844,621	\$354,240
Other Charges	\$(83,167)	\$(49,049)	\$(78,378)	\$(24,917)	\$(24,917)	\$24,132
Capital Assets	—	—	\$82,250	\$250	\$250	\$250
Other Financing Uses	—	\$175,000	—	—	—	\$(175,000)
Subtotal	\$840,929	\$1,319,710	\$1,144,135	\$1,565,253	\$1,565,253	\$245,543

Source of Funds

Revenues	Prior Year 2021-2022	Adopted Budget 2022-2023	CY Estimate 2022-2023	Requested Budget 2023-2024	Recommended Budget 2023-2024	Recommended Change from Adopted
General Fund Contributions	\$840,929	\$1,319,710	\$1,144,135	\$1,565,253	\$1,565,253	\$245,543
Total Source of Funds	\$840,929	\$1,319,710	\$1,144,135	\$1,565,253	\$1,565,253	\$245,543

Unit Description

Stormwater Floodplain Management is responsible for reviewing regulations and implementing the National Pollutant Discharge Elimination System (NPDES) Municipal General Permit and the Monterey Regional Stormwater Management Program (MRSWMP). Staff conduct site inspections, water quality sampling, and provide support for related programs.

Recommended FY 2023-24 Positions

Classification Code	Classification Label	FTE
41C02	WATER RESOURCES HYDROLOGIST	1.00
41C14	ASSOCIATE WATER RESOURCES HYDROLOGIST	1.00
41C17	SENIOR WATER RESOURCES HYDROLOGIST	1.00
43B03	WATER RESOURCES TECHNICIAN	1.00
Total		4.00

Roads & Bridges

(Budget Unit 8558—Fund 002—Appropriation Unit PFP004)

Use of Funds

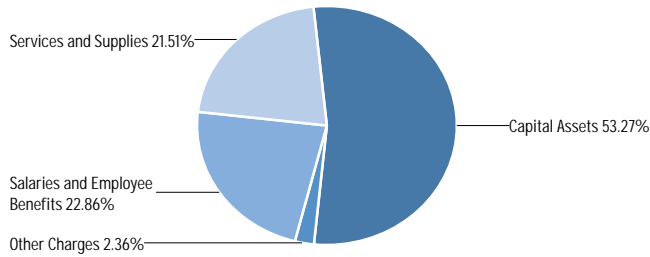

Source of Funds

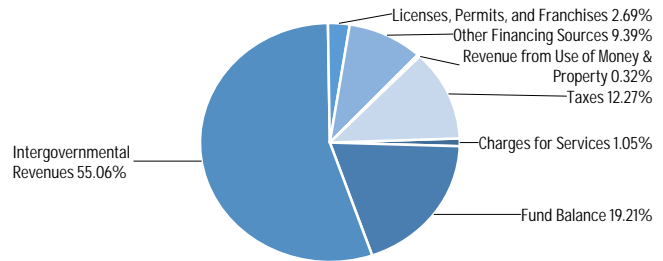

Use of Funds

Expenditures	Prior Year 2021-2022	Adopted Budget 2022-2023	CY Estimate 2022-2023	Requested Budget 2023-2024	Recommended Budget 2023-2024	Recommended Change from Adopted
Salaries and Employee Benefits	\$5,530,050	\$7,797,719	\$6,534,568	\$17,415,678	\$17,415,678	\$9,617,959
Services and Supplies	\$12,926,271	\$8,625,816	\$10,920,601	\$16,390,950	\$16,390,950	\$7,765,134
Other Charges	\$(590,651)	\$295,136	\$451,513	\$1,801,598	\$1,801,598	\$1,506,462
Capital Assets	\$10,474,355	\$43,433,828	\$30,788,001	\$40,588,763	\$40,588,763	\$(2,845,065)
Subtotal	\$28,340,024	\$60,152,499	\$48,694,683	\$76,196,989	\$76,196,989	\$16,044,490

Source of Funds

Revenues	Prior Year 2021-2022	Adopted Budget 2022-2023	CY Estimate 2022-2023	Requested Budget 2023-2024	Recommended Budget 2023-2024	Recommended Change from Adopted
Taxes	\$7,119,821	\$7,652,168	\$9,090,000	\$9,343,000	\$9,343,000	\$1,690,832
Licenses, Permits, and Franchises	\$234,119	\$173,132	\$513,962	\$2,050,000	\$2,050,000	\$1,876,868
Revenue from Use of Money & Property	\$126,036	\$77,762	\$220,755	\$244,642	\$244,642	\$166,880
Intergovernmental Revenues	\$16,001,957	\$49,279,216	\$34,579,738	\$41,921,340	\$41,921,340	\$(7,357,876)
Charges for Services	\$673,568	\$366,718	\$576,153	\$801,612	\$801,612	\$434,894
Miscellaneous Revenues	\$721,771	\$1,648,146	\$1,933,480	\$59,221	\$59,221	\$(1,588,925)
Other Financing Sources	\$3,622,639	\$2,911,482	\$2,976,282	\$7,152,976	\$7,152,976	\$4,241,494
Subtotal	\$28,499,910	\$62,108,624	\$49,890,370	\$61,572,791	\$61,572,791	\$(535,833)
Fund Balance	\$(159,886)	\$(1,956,125)	\$(1,195,687)	\$14,624,198	\$14,624,198	\$16,580,323
Total Source of Funds	\$28,340,024	\$60,152,499	\$48,694,683	\$76,196,989	\$76,196,989	\$16,044,490

Unit Description

The Road & Bridge Unit includes the capital projects management for the construction of County roads, bridges, streetlights, and traffic signals, as well as road and bridge maintenance. Road and Bridge maintains 1,264 miles of road and 175 bridges with various infrastructure within the County rights-of-way, which includes; pavement markings, striping, traffic signals, traffic signs, gutters, sidewalks, grading of shoulders, ditches and dirt roads, drainage culverts, vegetation, guardrails, sanitary sewer lift stations, flood management of the Carmel Lagoon and emergency response to multi-

hazards, as well as maintenance of over 60 miles of dirt roads within the Padres National Forest for the US Forest Service.

The primary sources of revenue for this Unit include State and Federal Grants, Transportation Safety & Investment Plan Local Tax Measure X, Road Maintenance and Rehabilitation Account (RMRA)/ Senate Bill 1 (SB 1), State Highway Users Tax Account (HUTA), Regional Surface Transportation Program (RSTRP), and an allocation from Transient Occupancy Tax (TOT) to meet the maintenance of effort requirement.

Recommended FY 2023-24 Positions

Classification Code	Classification Label	FTE
11A33	DIRECTOR OF PUBLIC WORKS, FACILITIES AND PARKS	1.00
14A11	PROJECT MANAGER II	2.00
14A12	PROJECT MANAGER III	3.00
14B32	SENIOR PERSONNEL ANALYST	1.00
14C30	MANAGEMENT ANALYST II	2.00
14C70	ADMINISTRATIVE SERVICES ASSISTANT	1.00
14K48	CAPITAL IMPROVEMENT MANAGER	1.00
16G24	GIS ANALYST II	1.00
20B11	ACCOUNTANT II	2.00
20B94	FINANCE MANAGER III	1.00
20B95	FINANCE MANAGER I	1.00
30D31	CHIEF OF PUBLIC WORKS	1.00
41A10	ASSISTANT ENGINEER	9.00
41A20	CIVIL ENGINEER	3.00
41A22	SENIOR CIVIL ENGINEER	3.00
41A87	CHIEF OF SURVEYS	1.00
43A23	ENGINEERING TECHNICIAN	8.00
74D12	ROAD MAINTENANCE WORKER	28.00
74D13	SENIOR ROAD MAINTENANCE WORKER	8.00
74D81	ASSISTANT ROAD SUPERINTENDENT	5.00
74D83	ROAD SUPERINTENDENT	4.00

Recommended FY 2023-24 Positions

Classification Code	Classification Label	FTE
74D84	ROAD MAINTENANCE SUPERINTENDENT	1.00
74D85	MAINTENANCE MANAGER	1.00
74E11	BRIDGE MAINTENANCE WORKER	6.00
74E31	SENIOR BRIDGE MAINTENANCE WORKER	1.00
74E80	ASSISTANT BRIDGE SUPERINTENDENT	1.00
74E81	BRIDGE SUPERINTENDENT	1.00
74G21	TREE TRIMMER	2.00
74G22	SENIOR TREE TRIMMER	1.00
74I11	TRAFFIC MAINTENANCE WORKER	6.00
74I25	TRAFFIC MAINTENANCE SUPERINTENDENT	1.00
80A31	SECRETARY	2.00
80A32	SENIOR SECRETARY	1.00
80E21	OFFICE ASSISTANT II	2.00
80E90	MAINTENANCE YARD CLERK	4.00
80E91	MAINTENANCE INVENTORY & YARD CLERK	1.00
80J22	SENIOR ACCOUNT CLERK	2.00
80J30	ACCOUNTING TECHNICIAN	3.00
Total		122.00

Road & Bridge Maintenance

(Budget Unit 8559—Fund 002—Appropriation Unit PFP004)

Use of Funds

Intentionally Left Blank

Source of Funds

Intentionally Left Blank

Use of Funds

Expenditures	Prior Year 2021-2022	Adopted Budget 2022-2023	CY Estimate 2022-2023	Requested Budget 2023-2024	Recommended Budget 2023-2024	Recommended Change from Adopted
Salaries and Employee Benefits	\$5,720,015	\$8,038,346	\$6,310,980	—	—	\$(8,038,346)
Services and Supplies	\$10,815,284	\$8,208,855	\$8,585,672	—	—	\$(8,208,855)
Other Charges	\$618,777	\$(680,701)	\$(680,701)	—	—	\$680,701
Capital Assets	\$844,595	\$1,350,000	\$1,342,981	—	—	\$(1,350,000)
Subtotal	\$17,998,671	\$16,916,500	\$15,558,932	—	—	\$(16,916,500)

Source of Funds

Revenues	Prior Year 2021-2022	Adopted Budget 2022-2023	CY Estimate 2022-2023	Requested Budget 2023-2024	Recommended Budget 2023-2024	Recommended Change from Adopted
Revenue from Use of Money & Property	\$(52,450)	—	—	—	—	—
Intergovernmental Revenues	\$11,527,068	\$13,480,835	\$12,800,129	—	—	\$(13,480,835)
Charges for Services	\$689,202	\$237,463	\$244,075	—	—	\$(237,463)
Miscellaneous Revenues	\$18,530	\$694,437	\$15,624	—	—	\$(694,437)
Other Financing Sources	\$2,032,170	\$3,086,287	\$3,086,287	—	—	\$(3,086,287)
Subtotal	\$14,214,519	\$17,499,022	\$16,146,115	—	—	\$(17,499,022)
Fund Balance	\$3,784,152	\$(582,522)	\$(587,183)	—	—	\$582,522
Total Source of Funds	\$17,998,671	\$16,916,500	\$15,558,932	—	—	\$(16,916,500)

Unit Description

Beginning with FY 2023-24, the Road and Bridge Maintenance Unit was combined with the Road and Bridge Engineering Unit 8558.

Fish & Game Propagation

(Budget Unit 8560—Fund 006—Appropriation Unit PFP059)

Use of Funds

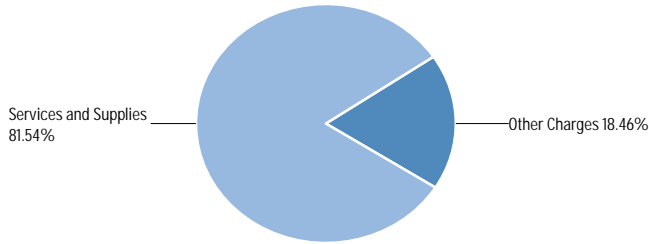

Source of Funds

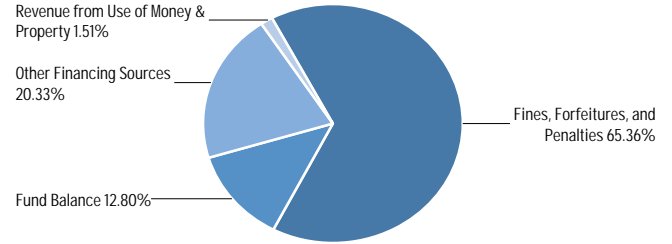

Use of Funds

Expenditures	Prior Year 2021-2022	Adopted Budget 2022-2023	CY Estimate 2022-2023	Requested Budget 2023-2024	Recommended Budget 2023-2024	Recommended Change from Adopted
Services and Supplies	\$38,895	\$52,327	\$41,014	\$42,105	\$42,105	\$(10,222)
Other Charges	\$672	\$(180)	\$(180)	\$9,531	\$9,531	\$9,711
Subtotal	\$39,567	\$52,147	\$40,834	\$51,636	\$51,636	\$(511)

Source of Funds

Revenues	Prior Year 2021-2022	Adopted Budget 2022-2023	CY Estimate 2022-2023	Requested Budget 2023-2024	Recommended Budget 2023-2024	Recommended Change from Adopted
Fines, Forfeitures, and Penalties	\$38,660	\$38,214	\$41,107	\$33,748	\$33,748	\$(4,466)
Revenue from Use of Money & Property	\$338	\$307	\$307	\$781	\$781	\$474
Other Financing Sources	\$10,500	\$10,500	\$10,500	\$10,500	\$10,500	—
Subtotal	\$49,498	\$49,021	\$51,914	\$45,029	\$45,029	\$(3,992)
Fund Balance	\$(9,931)	\$3,126	\$(11,080)	\$6,607	\$6,607	\$3,481
Total Source of Funds	\$39,567	\$52,147	\$40,834	\$51,636	\$51,636	\$(511)

Unit Description

The Monterey County Fish and Game Advisory Commission supports the preservation and enhancement of the County fish and wildlife resources, including funding local youth and outdoor education through Grant Awards. The Commission is under the authority of the Monterey County Board of Supervisors and serves in an advisory capacity. PWWP-Parks personnel provide administration services and support to the Commission. The Commission receives a percentage of

fine monies from enforcement activities by the State Department of Fish and Wildlife Game Wardens. The Commission oversees the allocation of Fish and Game Propagation Funds generated from the fines received and recommends grant awards to the Board of Supervisors to fund qualified organizations and agencies undertaking fish and wildlife preservation, protection, and educational projects or programs.

East Garrison Public Financing Authority

(Budget Unit 8561—Fund 180—Appropriation Unit PFP005)

Use of Funds

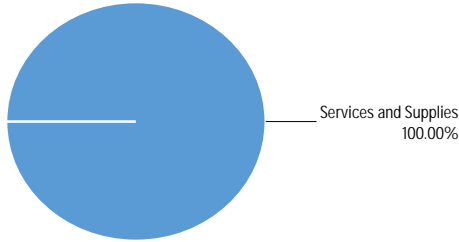

Source of Funds

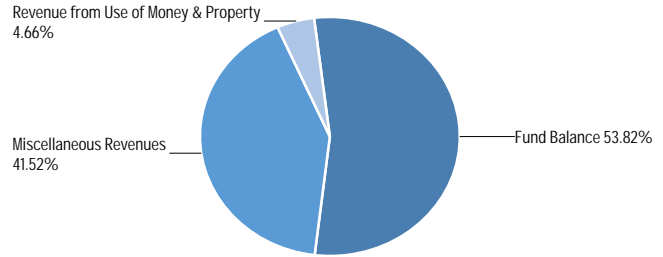

Use of Funds

Expenditures	Prior Year 2021-2022	Adopted Budget 2022-2023	CY Estimate 2022-2023	Requested Budget 2023-2024	Recommended Budget 2023-2024	Recommended Change from Adopted
Services and Supplies	\$18,892	\$43,925	\$38,925	\$36,125	\$36,125	\$(7,800)
Subtotal	\$18,892	\$43,925	\$38,925	\$36,125	\$36,125	\$(7,800)

Source of Funds

Revenues	Prior Year 2021-2022	Adopted Budget 2022-2023	CY Estimate 2022-2023	Requested Budget 2023-2024	Recommended Budget 2023-2024	Recommended Change from Adopted
Revenue from Use of Money & Property	\$538	\$1,000	\$1,000	\$1,683	\$1,683	\$683
Miscellaneous Revenues	—	\$39,750	\$15,000	\$15,000	\$15,000	\$(24,750)
Subtotal	\$538	\$40,750	\$16,000	\$16,683	\$16,683	\$(24,067)
Fund Balance	\$18,355	\$3,175	\$22,925	\$19,442	\$19,442	\$16,267
Total Source of Funds	\$18,892	\$43,925	\$38,925	\$36,125	\$36,125	\$(7,800)

Unit Description

In 2006, the Board of Supervisors created Community Facilities District (CFD) Number 2006-1 (East Garrison CFD). This Unit includes activities related to the collection and disbursement of facilities special tax revenue collected in the East Garrison CFD. The facilities special tax unit was set up to acquire constructed facilities from the East Garrison Developer (up to a maximum of \$20 million) either through the issuance of bonds or through a pay-as-you-go

method. Revenues include special taxes collected, interest earned on unused funds, and penalties from delinquent special facilities taxes.

Specific activities funded in this unit include payment of administrative expenses, as defined in the rate and method of apportionment for the fiscal year, and construction or acquisition of authorized facilities.

East Garrison Community Service District

(Budget Unit 8562—Fund 181—Appropriation Unit PFP006)

Use of Funds

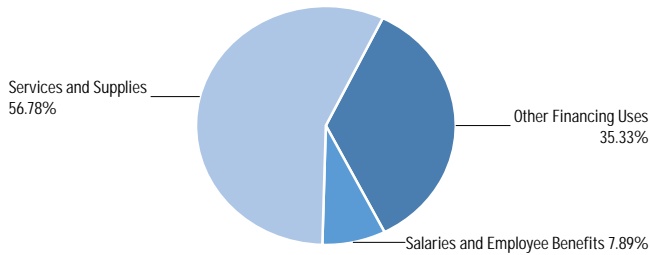

Source of Funds

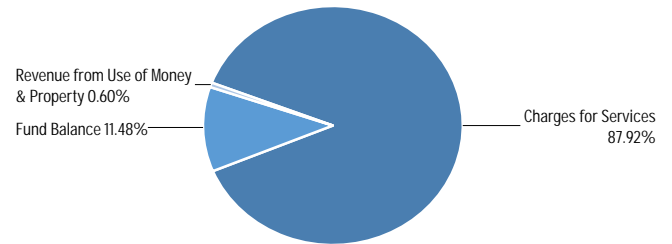

Use of Funds

Expenditures	Prior Year 2021-2022	Adopted Budget 2022-2023	CY Estimate 2022-2023	Requested Budget 2023-2024	Recommended Budget 2023-2024	Recommended Change from Adopted
Salaries and Employee Benefits	—	—	—	\$158,424	\$158,424	\$158,424
Services and Supplies	\$1,199,989	\$1,329,628	\$1,356,341	\$1,139,661	\$1,139,661	\$(189,967)
Other Charges	\$876	\$2,000	\$2,000	\$(9,606)	\$(9,606)	\$(11,606)
Other Financing Uses	\$614,733	\$678,629	\$677,421	\$709,041	\$709,041	\$30,412
Subtotal	\$1,815,598	\$2,010,257	\$2,035,762	\$1,997,520	\$1,997,520	\$(12,737)

Source of Funds

Revenues	Prior Year 2021-2022	Adopted Budget 2022-2023	CY Estimate 2022-2023	Requested Budget 2023-2024	Recommended Budget 2023-2024	Recommended Change from Adopted
Revenue from Use of Money & Property	\$7,058	\$13,954	\$12,000	\$12,000	\$12,000	\$(1,954)
Charges for Services	\$1,671,039	\$1,853,613	\$1,705,000	\$1,756,150	\$1,756,150	\$(97,463)
Other Financing Sources	\$5,019	—	—	—	—	—
Subtotal	\$1,683,116	\$1,867,567	\$1,717,000	\$1,768,150	\$1,768,150	\$(99,417)
Fund Balance	\$132,482	\$142,690	\$318,762	\$229,370	\$229,370	\$86,680
Total Source of Funds	\$1,815,598	\$2,010,257	\$2,035,762	\$1,997,520	\$1,997,520	\$(12,737)

Unit Description

The East Garrison Community Service District (EGCSD) Unit includes activities related to the collection and disbursement of funds for designated services provided in the East Garrison project. County and District services provided include Sheriff patrol operations, street maintenance, drainage maintenance, park/open space maintenance, and administration.

Recommended FY 2023-24 Positions

Classification Code	Classification Label	FTE
14C30	MANAGEMENT ANALYST II	1.00
Total		1.00

Capital Projects

(Budget Unit 8563—Fund 402—Appropriation Unit PFP056)

Use of Funds

Source of Funds

Intentionally Left Blank

Intentionally Left Blank

Use of Funds

Expenditures	Prior Year 2021-2022	Adopted Budget 2022-2023	CY Estimate 2022-2023	Requested Budget 2023-2024	Recommended Budget 2023-2024	Recommended Change from Adopted
Services and Supplies	\$612,266	—	—	—	—	—
Other Charges	\$(334,656)	—	—	—	—	—
Capital Assets	\$3,828,085	—	—	—	—	—
Subtotal	\$4,105,694	—	—	—	—	—

Source of Funds

Revenues	Prior Year 2021-2022	Adopted Budget 2022-2023	CY Estimate 2022-2023	Requested Budget 2023-2024	Recommended Budget 2023-2024	Recommended Change from Adopted
Revenue from Use of Money & Property	\$10,600	—	—	—	—	—
Miscellaneous Revenues	\$154,594	—	—	—	—	—
Other Financing Sources	\$1,571,443	—	—	—	—	—
Subtotal	\$1,736,637	—	—	—	—	—
Fund Balance	\$2,369,057	—	—	—	—	—
Total Source of Funds	\$4,105,694	—	—	—	—	—

Unit Description

Beginning with FY 2022-23, this unit was closed, and future activity is reported in Capital Projects Fund 404.

Capital Projects

(Budget Unit 8564—Fund 404—Appropriation Unit PFP057)

Use of Funds

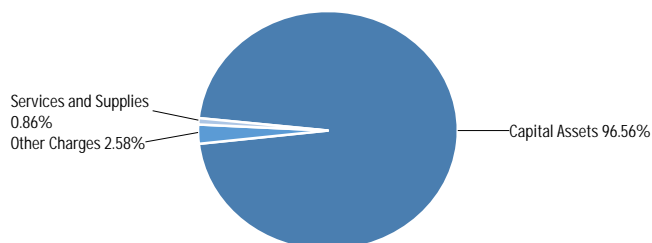

Source of Funds

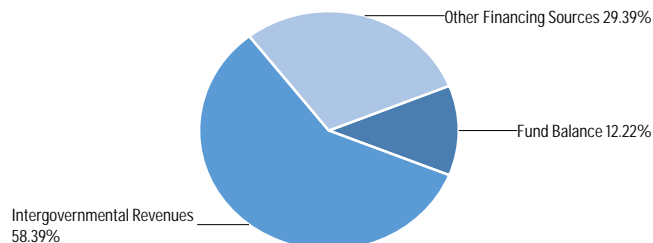

Use of Funds

Expenditures	Prior Year 2021-2022	Adopted Budget 2022-2023	CY Estimate 2022-2023	Requested Budget 2023-2024	Recommended Budget 2023-2024	Recommended Change from Adopted
Services and Supplies	\$3,465,512	\$999,492	\$225,000	\$225,000	\$225,000	\$(774,492)
Other Charges	\$(34,799)	\$189,709	\$189,709	\$679,546	\$679,546	\$489,837
Capital Assets	\$4,694,621	\$47,863,508	\$48,158,824	\$106,980,659	\$25,389,538	\$(22,473,970)
Subtotal	\$8,125,334	\$49,052,709	\$48,573,533	\$107,885,205	\$26,294,084	\$(22,758,625)

Source of Funds

Revenues	Prior Year 2021-2022	Adopted Budget 2022-2023	CY Estimate 2022-2023	Requested Budget 2023-2024	Recommended Budget 2023-2024	Recommended Change from Adopted
Revenue from Use of Money & Property	\$(30,776)	—	\$41,673	—	—	—
Intergovernmental Revenues	\$1,945,398	\$28,727,347	\$19,193,632	\$15,354,220	\$15,354,220	\$(13,373,127)
Miscellaneous Revenues	\$177,561	—	\$6,506	—	—	—
Other Financing Sources	\$18,008,498	\$18,396,296	\$26,199,966	\$7,727,256	\$7,727,256	\$(10,669,040)
Subtotal	\$20,100,682	\$47,123,643	\$45,441,777	\$23,081,476	\$23,081,476	\$(24,042,167)
Fund Balance	\$(11,975,349)	\$1,929,066	\$3,131,756	\$84,803,729	\$3,212,608	\$1,283,542
Total Source of Funds	\$8,125,334	\$49,052,709	\$48,573,533	\$107,885,205	\$26,294,084	\$(22,758,625)

Unit Description

The Capital Projects Fund accounts for financial resources used for the acquisition or construction of major capital assets. These include land and land improvements, buildings and building improvements, infrastructure, and construction in progress. American Rescue Plan Act (ARPA) infrastructure water projects are included in the budget, along with Prop 68 Park projects, and several County HVAC unit replacement projects.

Effective FY 2022-23, Capital Project Fund 402 was closed, and all Capital Project activity is reported in Fund 404. Originally, the two separate funds were established to track capital projects funded with County funds (Fund 402) vs. those funded with debt or other resources (Fund 404). County has ability to distinguish funding for projects within one single fund and therefore there is no longer a need for separate funds.

Nacimiento Lake & Resort Operations

(Budget Unit 8565—Fund 452—Appropriation Unit PFP060)

Use of Funds

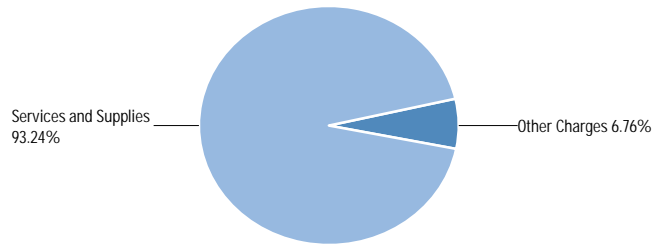

Source of Funds

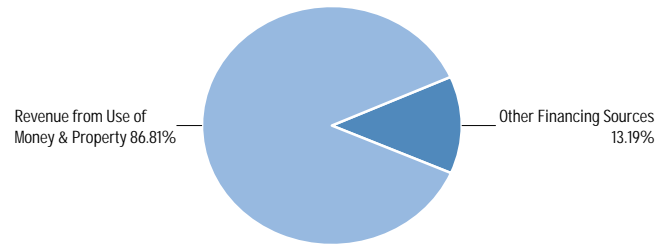

Use of Funds

Expenditures	Prior Year 2021-2022	Adopted Budget 2022-2023	CY Estimate 2022-2023	Requested Budget 2023-2024	Recommended Budget 2023-2024	Recommended Change from Adopted
Services and Supplies	\$3,232,044	\$3,843,323	\$3,348,444	\$3,437,588	\$3,437,588	\$(405,735)
Other Charges	\$114,169	\$350,280	\$350,280	\$249,094	\$249,094	\$(101,186)
Other Financing Uses	\$16,621	—	—	—	—	—
Subtotal	\$3,362,834	\$4,193,603	\$3,698,724	\$3,686,682	\$3,686,682	\$(506,921)

Source of Funds

Revenues	Prior Year 2021-2022	Adopted Budget 2022-2023	CY Estimate 2022-2023	Requested Budget 2023-2024	Recommended Budget 2023-2024	Recommended Change from Adopted
Revenue from Use of Money & Property	\$3,427,205	\$4,084,434	\$2,752,127	\$3,417,592	\$3,417,592	\$(666,842)
Charges for Services	\$500	—	—	—	—	—
Miscellaneous Revenues	\$28,220	—	—	—	—	—
Other Financing Sources	\$520,340	\$519,205	\$519,205	\$519,204	\$519,204	\$(1)
Subtotal	\$3,976,265	\$4,603,639	\$3,271,332	\$3,936,796	\$3,936,796	\$(666,843)
Fund Balance	\$(613,432)	\$(410,036)	\$427,392	\$(250,114)	\$(250,114)	\$159,922
Total Source of Funds	\$3,362,834	\$4,193,603	\$3,698,724	\$3,686,682	\$3,686,682	\$(506,921)

Unit Description

The Lakes Unit encompasses all aspects of support to the resort operations at Lake Nacimiento. The lake park facilities offer a spectrum of recreational opportunities for visitors including camping, day-use, fishing, furnished lodging, boat launch ramps, boating and

water sport rentals, full-service marinas, general store, snack bar and ancillary services. A management company is contracted to operate the entry gate, marina, store, service station, campgrounds and condominium units and lake view lodges.

Community Service Areas

(Budget Unit 8566— All Funds)

Use of Funds

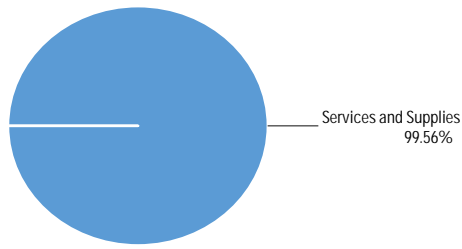

Source of Funds

Intentionally Left Blank

Use of Funds

Expenditures	Prior Year 2021-2022	Adopted Budget 2022-2023	CY Estimate 2022-2023	Requested Budget 2023-2024	Recommended Budget 2023-2024	Recommended Change from Adopted
Services and Supplies	\$1,133,347	\$3,661,391	\$970,213	\$4,171,750	\$4,171,750	\$510,359
Other Charges	\$16,506	\$18,531	\$18,530	\$18,606	\$18,606	\$75
Subtotal - all funds	\$1,149,854	\$3,679,922	\$988,743	\$4,190,356	\$4,190,356	\$510,434

Source of Funds

Revenues	Prior Year 2021-2022	Adopted Budget 2022-2023	CY Estimate 2022-2023	Requested Budget 2023-2024	Recommended Budget 2023-2024	Recommended Change from Adopted
Taxes	\$623,432	\$608,148	\$607,510	\$625,066	\$625,066	\$16,918
Revenue from Use of Money & Property	\$38,836	\$44,840	\$41,960	\$44,840	\$44,840	—
Intergovernmental Revenues	\$2,263	\$2,393	\$2,390	\$2,396	\$2,396	\$3
Charges for Services	\$522,157	\$451,890	\$451,440	\$451,890	\$451,890	—
Other Financing Sources	—	\$485,000	—	\$485,000	\$485,000	—
Subtotal - all funds	\$1,186,689	\$1,598,271	\$1,103,300	\$1,609,192	\$1,609,192	\$16,921
Fund Balance	\$(36,835)	\$2,087,651	\$(114,557)	\$2,857,164	\$2,857,164	\$493,513
Total Source of Funds	\$1,149,854	\$3,679,922	\$988,743	\$4,190,356	\$4,190,356	\$510,434

Unit Description

The County has 40 individual Community Service Areas (CSAs) of which all but two are active. The CSAs provide a variety of urban services to unincorporated areas of the County. These services include park maintenance, street lighting, street and sidewalk maintenance,

storm drain maintenance, surface water disposal, sewage collection and disposal, levee maintenance and repair, and operation of the CSAs. The Board of Supervisors acts as the governing body on behalf of the CSAs, and Special District Administration Unit 8555 administers the maintenance and operations of the CSAs.

Community Service Districts

(Budget Unit 8567— All Funds)

Use of Funds

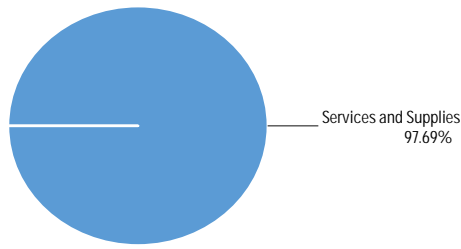

Source of Funds

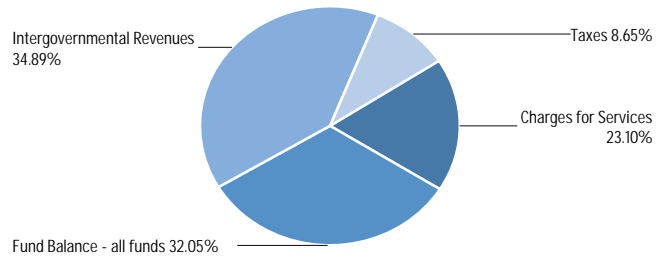

Use of Funds

Expenditures	Prior Year 2021-2022	Adopted Budget 2022-2023	CY Estimate 2022-2023	Requested Budget 2023-2024	Recommended Budget 2023-2024	Recommended Change from Adopted
Services and Supplies	\$1,790,449	\$1,421,444	\$2,637,806	\$3,252,118	\$3,252,118	\$1,830,674
Other Charges	\$30	\$30	\$38,880	\$38,280	\$38,280	\$350
Other Financing Uses	\$38,350	\$38,350	\$38,350	\$38,250	\$38,250	—
Subtotal - all funds	\$1,827,382	\$1,497,974	\$2,714,906	\$3,328,998	\$3,328,998	\$1,831,024

Source of Funds

Revenues	Prior Year 2021-2022	Adopted Budget 2022-2023	CY Estimate 2022-2023	Requested Budget 2023-2024	Recommended Budget 2023-2024	Recommended Change from Adopted
Taxes	\$296,764	\$279,889	\$279,889	\$288,066	\$288,066	\$8,117
Licenses, Permits, and Franchises	\$900	\$1,200	\$1,200	\$1,200	\$1,200	—
Revenue from Use of Money & Property	\$2,058	\$3,702	\$3,702	\$3,702	\$3,702	—
Intergovernmental Revenues	\$79,523	\$1,273	\$1,273	\$1,273	\$1,161,436	\$1,160,163
Charges for Services	\$768,235	\$869,000	\$769,000	\$769,000	\$769,000	\$(100,000)
Other Financing Sources	\$463,232	\$38,250	\$2,674,650	\$38,600	\$38,600	\$350
Subtotal - all funds	\$1,610,712	\$1,193,314	\$3,729,714	\$1,101,781	\$2,261,944	\$1,068,630
Fund Balance	\$216,670	\$304,660	\$(1,014,808)	\$2,227,217	\$1,067,054	\$762,394
Total Source of Funds	\$1,827,382	\$1,497,974	\$2,714,906	\$3,328,998	\$3,328,998	\$1,831,024

Unit Description

There are two active County Sanitation Districts (CSDs), Pajaro and Boronda, which the Board of Supervisors act as the governing body.

The CSDs provide sanitation (wastewater collection) services. Boronda CSD also includes the San Jerardo Water System Zone 2, which provides potable water to the San Jerardo Cooperative.

Administration

(Budget Unit 8569—Fund 001—Appropriation Unit PFP062)

Use of Funds

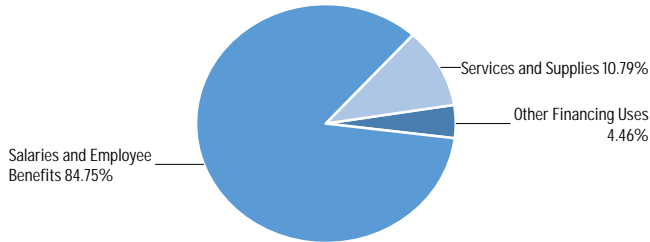

Source of Funds

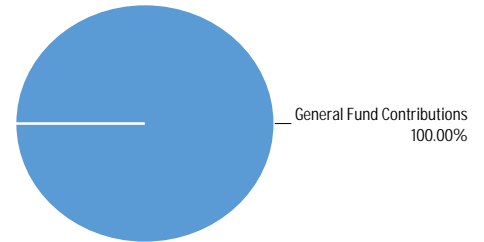

Use of Funds

Expenditures	Prior Year 2021-2022	Adopted Budget 2022-2023	CY Estimate 2022-2023	Requested Budget 2023-2024	Recommended Budget 2023-2024	Recommended Change from Adopted
Salaries and Employee Benefits	\$1,800,624	\$1,637,308	\$1,642,588	\$2,132,825	\$2,132,825	\$495,517
Services and Supplies	\$330,779	\$298,984	\$320,083	\$271,520	\$271,520	\$(27,464)
Other Charges	\$1,598,999	\$1,986,018	\$2,032,148	\$(1,925,173)	\$(1,925,173)	\$(3,911,191)
Capital Assets	\$8,472	—	—	—	—	—
Other Financing Uses	\$139,701	\$114,263	\$69,495	\$112,345	\$112,345	\$(1,918)
Subtotal	\$3,878,575	\$4,036,573	\$4,064,314	\$591,517	\$591,517	\$(3,445,056)

Source of Funds

Revenues	Prior Year 2021-2022	Adopted Budget 2022-2023	CY Estimate 2022-2023	Requested Budget 2023-2024	Recommended Budget 2023-2024	Recommended Change from Adopted
Charges for Services	\$16	—	\$(10)	—	—	—
Miscellaneous Revenues	\$164	—	—	—	—	—
Subtotal	\$180	—	\$(10)	—	—	—
General Fund Contributions	\$3,878,394	\$4,036,573	\$4,064,324	\$591,517	\$591,517	\$(3,445,056)
Total Source of Funds	\$3,878,575	\$4,036,573	\$4,064,314	\$591,517	\$591,517	\$(3,445,056)

Unit Description

The Administration unit provides executive direction, oversight, coordination, and centralized administrative staff support of the operational areas within Public Works, Facilities, and Parks, including payroll, contracts/purchasing, and human resources.

Recommended FY 2023-24 Positions

Classification Code	Classification Label	FTE
12C23	ASSISTANT DIRECTOR OF PUBLIC WORKS, FACILITIES AND PARKS	1.00
14B21	ASSOCIATE PERSONNEL ANALYST	1.00
14C30	MANAGEMENT ANALYST II	3.00
14C31	MANAGEMENT ANALYST III	1.00
14H03	PERSONNEL TECHNICIAN-CONFIDENTIAL	1.00
20B10	ACCOUNTANT I	2.00
80J20	ACCOUNTING CLERICAL SUPERVISOR	1.00
80J22	SENIOR ACCOUNT CLERK	3.00
Total		13.00

Records Retention

(Budget Unit 8574—Fund 001—Appropriation Unit PFP063)

Use of Funds

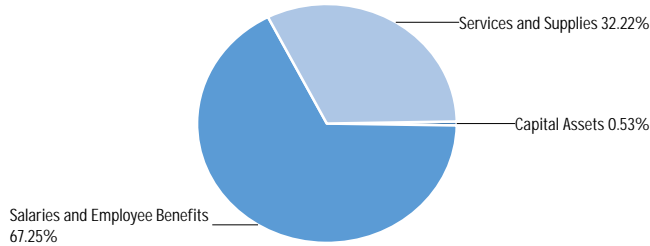

Source of Funds

Intentionally Left Blank

Use of Funds

Expenditures	Prior Year 2021-2022	Adopted Budget 2022-2023	CY Estimate 2022-2023	Requested Budget 2023-2024	Recommended Budget 2023-2024	Recommended Change from Adopted
Salaries and Employee Benefits	—	\$655,170	\$501,779	\$568,525	\$568,525	\$(86,645)
Services and Supplies	—	\$306,740	\$213,221	\$272,382	\$272,382	\$(34,358)
Other Charges	—	\$(1,364,409)	\$(1,122,018)	\$(877,087)	\$(877,087)	\$487,322
Capital Assets	—	—	\$4,520	\$4,520	\$4,520	\$4,520
Subtotal	—	\$(402,499)	\$(402,498)	\$(31,660)	\$(31,660)	\$370,839

Source of Funds

Revenues	Prior Year 2021-2022	Adopted Budget 2022-2023	CY Estimate 2022-2023	Requested Budget 2023-2024	Recommended Budget 2023-2024	Recommended Change from Adopted
General Fund Contributions	—	\$(402,499)	\$(402,498)	\$(31,660)	\$(31,660)	\$370,839
Total Source of Funds	—	\$(402,499)	\$(402,498)	\$(31,660)	\$(31,660)	\$370,839

Unit Description

The Records Retention unit is responsible for providing highly secure, environmentally sound, seismic structurally tested, cost-effective solutions for the storage, retrieval, management, and destruction of paper files, charts, drawings, and blueprints which must be retained for audit, legal, fiscal, or administrative needs in compliance with recordkeeping policy requirements.

Recommended FY 2023-24 Positions

Classification Code	Classification Label	FTE
70F23	STOREKEEPER	5.00
70F81	SUPERVISING STOREKEEPER	1.00
Total		6.00

Courier

(Budget Unit 8575—Fund 001—Appropriation Unit PFP064)

Use of Funds

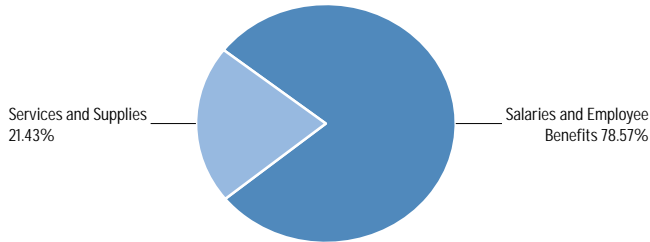

Source of Funds

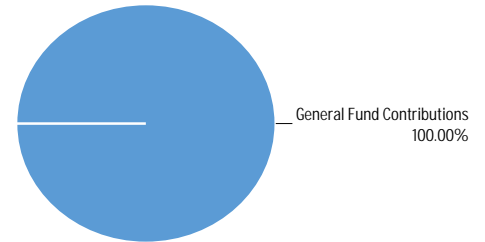

Use of Funds

Expenditures	Prior Year 2021-2022	Adopted Budget 2022-2023	CY Estimate 2022-2023	Requested Budget 2023-2024	Recommended Budget 2023-2024	Recommended Change from Adopted
Salaries and Employee Benefits	—	\$513,442	\$434,772	\$476,480	\$476,480	\$(36,962)
Services and Supplies	—	\$95,806	\$68,031	\$129,924	\$129,924	\$34,118
Other Charges	—	\$(806,301)	\$(699,855)	\$(518,600)	\$(518,600)	\$287,701
Subtotal	—	\$(197,053)	\$(197,052)	\$87,804	\$87,804	\$284,857

Source of Funds

Revenues	Prior Year 2021-2022	Adopted Budget 2022-2023	CY Estimate 2022-2023	Requested Budget 2023-2024	Recommended Budget 2023-2024	Recommended Change from Adopted
General Fund Contributions	—	\$(197,053)	\$(197,052)	\$87,804	\$87,804	\$284,857
Total Source of Funds	—	\$(197,053)	\$(197,052)	\$87,804	\$87,804	\$284,857

Unit Description

The Courier unit is responsible for the pickup, delivery, and distribution of all inter-office and USPS business mail and packages. Operating costs for the Courier Unit are covered entirely through charges for services. Courier processes more than 1 million pieces of mail annually and provides courier service for more than 130 mail stops.

Recommended FY 2023-24 Positions

Classification Code	Classification Label	FTE
70F21	COURIER	4.00
80023	SENIOR MAILROOM CLERK	1.00
Total		5.00

Mail

(Budget Unit 8576—Fund 001—Appropriation Unit PFP064)

Use of Funds

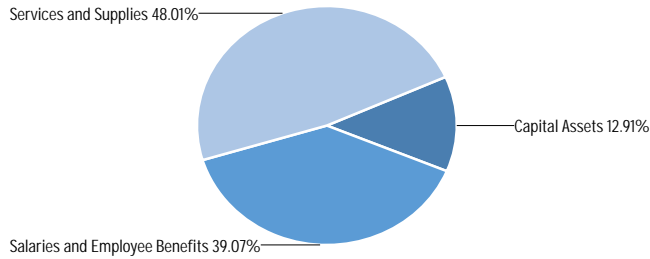

Source of Funds

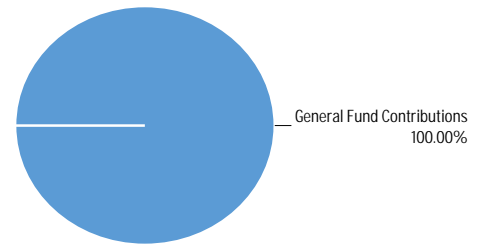

Use of Funds

Expenditures	Prior Year 2021-2022	Adopted Budget 2022-2023	CY Estimate 2022-2023	Requested Budget 2023-2024	Recommended Budget 2023-2024	Recommended Change from Adopted
Salaries and Employee Benefits	—	\$127,382	\$52,152	\$127,306	\$127,306	\$(76)
Services and Supplies	—	\$189,572	\$123,196	\$156,428	\$156,428	\$(33,144)
Other Charges	—	\$(421,862)	\$(282,232)	\$(309,387)	\$(309,387)	\$112,475
Capital Assets	—	—	\$1,974	\$42,076	\$42,076	\$42,076
Subtotal	—	\$(104,908)	\$(104,910)	\$16,423	\$16,423	\$121,331

Source of Funds

Revenues	Prior Year 2021-2022	Adopted Budget 2022-2023	CY Estimate 2022-2023	Requested Budget 2023-2024	Recommended Budget 2023-2024	Recommended Change from Adopted
General Fund Contributions	—	\$(104,908)	\$(104,910)	\$16,423	\$16,423	\$121,331
Total Source of Funds	—	\$(104,908)	\$(104,910)	\$16,423	\$16,423	\$121,331

Unit Description

The Mail Services unit is responsible for the collection, distribution, presorting, and automated postage metering for all outbound United State Postal Service mail as well as United Parcel Service shipments. Costs for this unit are entirely covered through charges for services.

Recommended FY 2023-24 Positions

Classification Code	Classification Label	FTE
70F21	COURIER	1.00
80022	MAILROOM CLERK	0.50
Total		1.50

Fleet Administration

(Budget Unit 8577—Fund 001—Appropriation Unit PFP065)

Use of Funds

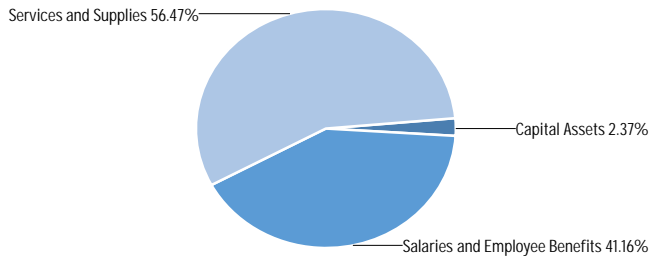

Source of Funds

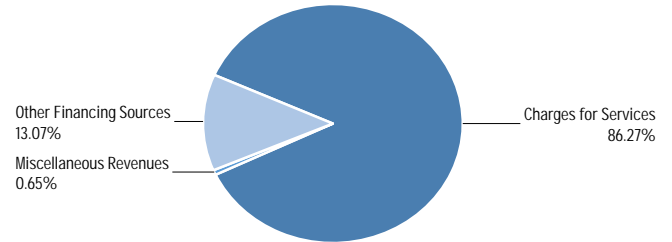

Use of Funds

Expenditures	Prior Year 2021-2022	Adopted Budget 2022-2023	CY Estimate 2022-2023	Requested Budget 2023-2024	Recommended Budget 2023-2024	Recommended Change from Adopted
Salaries and Employee Benefits	—	\$3,428,806	\$2,903,840	\$3,502,961	\$3,502,961	\$74,155
Services and Supplies	—	\$3,973,266	\$4,303,832	\$4,805,410	\$4,805,410	\$832,144
Other Charges	—	\$(6,931,930)	\$(6,723,725)	\$(8,759,360)	\$(8,759,360)	\$(1,827,430)
Capital Assets	—	\$130,000	\$121,578	\$201,900	\$201,900	\$71,900
Subtotal	—	\$600,142	\$605,525	\$(249,089)	\$(249,089)	\$(849,231)

Source of Funds

Revenues	Prior Year 2021-2022	Adopted Budget 2022-2023	CY Estimate 2022-2023	Requested Budget 2023-2024	Recommended Budget 2023-2024	Recommended Change from Adopted
Charges for Services	—	\$60,352	\$65,171	\$66,000	\$66,000	\$5,648
Miscellaneous Revenues	—	—	\$565	\$500	\$500	\$500
Other Financing Sources	—	\$15,000	\$15,000	\$10,000	\$10,000	\$(5,000)
Subtotal	—	\$75,352	\$80,736	\$76,500	\$76,500	\$1,148
General Fund Contributions	—	\$524,790	\$524,789	\$(325,589)	\$(325,589)	\$(850,379)
Total Source of Funds	—	\$600,142	\$605,525	\$(249,089)	\$(249,089)	\$(849,231)

Unit Description

Fleet Administration unit is responsible for providing services for the repairs and maintenance of over 2,600 pieces of equipment including County passenger vehicles and heavy equipment to maintain compliance with government regulations. Fleet also operates an automated vehicle rental program (Invers), multiple fueling sites, and manages a vehicle replacement program.

Recommended FY 2023-24 Positions

Classification Code	Classification Label	FTE
14C30	MANAGEMENT ANALYST II	1.00
14E01	BUYER I	1.00
14H64	FLEET MANAGER	1.00
20B10	ACCOUNTANT I	1.00
43L18	COMMUNICATIONS TECHNICIAN III	1.00

Recommended FY 2023-24 Positions

Classification Code	Classification Label	FTE
43L20	COMMUNICATIONS TECHNICIAN I	1.00
43L42	VEHICLE INSTALLATION SPECIALIST	1.00
70F10	FLEET PARTS COORDINATOR	1.00
70F12	SENIOR FLEET PARTS COORDINATOR	1.00
72C20	MECHANIC I	1.00
72C23	MECHANIC II	11.00
72C26	MECHANIC III	2.00
72C82	SUPERVISING MECHANIC	1.00
72C83	FLEET SERVICE WRITER	1.00
80J22	SENIOR ACCOUNT CLERK	1.00
Total		26.00

Rifle Range

(Budget Unit 8578—Fund 001—Appropriation Unit PFP066)

Use of Funds

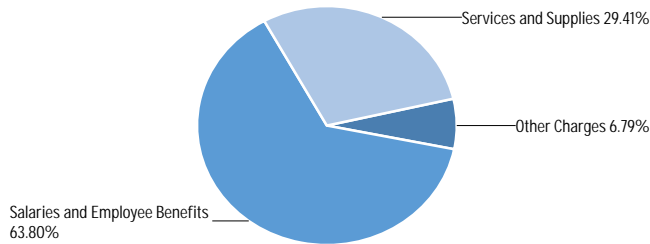

Source of Funds

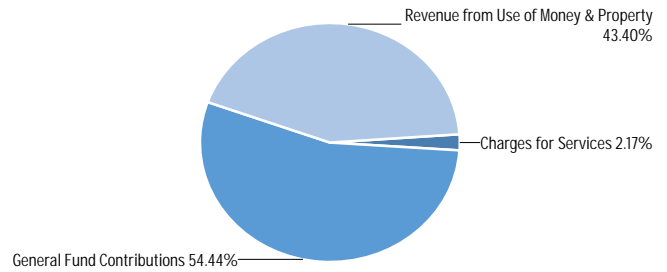

Use of Funds

Expenditures	Prior Year 2021-2022	Adopted Budget 2022-2023	CY Estimate 2022-2023	Requested Budget 2023-2024	Recommended Budget 2023-2024	Recommended Change from Adopted
Salaries and Employee Benefits	—	\$176,356	\$163,318	\$176,750	\$176,750	\$394
Services and Supplies	—	\$44,374	\$52,998	\$81,466	\$81,466	\$37,092
Other Charges	—	\$8,619	\$8,619	\$18,823	\$18,823	\$10,204
Subtotal	—	\$229,349	\$224,935	\$277,039	\$277,039	\$47,690

Source of Funds

Revenues	Prior Year 2021-2022	Adopted Budget 2022-2023	CY Estimate 2022-2023	Requested Budget 2023-2024	Recommended Budget 2023-2024	Recommended Change from Adopted
Revenue from Use of Money & Property	—	\$153,270	\$120,229	\$120,229	\$120,229	\$(33,041)
Charges for Services	—	\$3,000	\$6,000	\$6,000	\$6,000	\$3,000
Subtotal	—	\$156,270	\$126,229	\$126,229	\$126,229	\$(30,041)
General Fund Contributions	—	\$73,079	\$98,706	\$150,810	\$150,810	\$77,731
Total Source of Funds	—	\$229,349	\$224,935	\$277,039	\$277,039	\$47,690

Unit Description

Laguna Seca Rifle and Pistol Range offers a safe shooting environment year-round with a well-trained staff. The range includes 15 rifle stalls and 10 pistol stalls using paper targets and 10 shooting stalls with reactive steel targets for pistols and rifles. The range can be reserved for groups and local law enforcement agencies.

Recommended FY 2023-24 Positions

Classification Code	Classification Label	FTE
68A30	RANGE MASTER	1.00
68C02	RANGE AIDE	1.00
Total		2.00

Laguna Seca

(Budget Unit 8579—Fund 453—Appropriation Unit PFP067)

Use of Funds

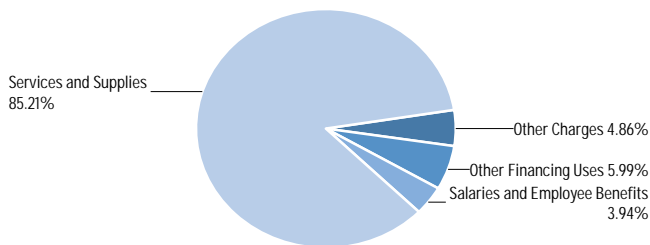

Source of Funds

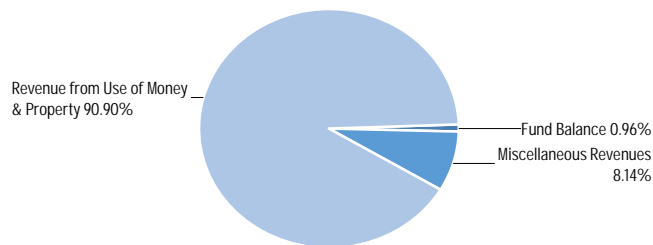

Use of Funds

Expenditures	Prior Year 2021-2022	Adopted Budget 2022-2023	CY Estimate 2022-2023	Requested Budget 2023-2024	Recommended Budget 2023-2024	Recommended Change from Adopted
Salaries and Employee Benefits	—	\$1,087,665	\$826,395	\$1,075,228	\$1,075,228	\$(12,437)
Services and Supplies	—	\$16,731,791	\$15,879,881	\$23,257,286	\$23,257,286	\$6,525,495
Other Charges	—	\$741,187	\$1,029,093	\$1,326,921	\$1,326,921	\$585,734
Other Financing Uses	—	—	—	\$1,634,459	\$1,634,459	\$1,634,459
Subtotal	—	\$18,560,643	\$17,735,369	\$27,293,894	\$27,293,894	\$8,733,251

Source of Funds

Revenues	Prior Year 2021-2022	Adopted Budget 2022-2023	CY Estimate 2022-2023	Requested Budget 2023-2024	Recommended Budget 2023-2024	Recommended Change from Adopted
Revenue from Use of Money & Property	—	\$17,524,645	\$16,056,366	\$24,810,312	\$24,810,312	\$7,285,667
Miscellaneous Revenues	—	\$520,000	\$926,044	\$2,220,696	\$2,220,696	\$1,700,696
Subtotal	—	\$18,044,645	\$16,982,410	\$27,031,008	\$27,031,008	\$8,986,363
Fund Balance	—	\$515,998	\$752,959	\$262,886	\$262,886	\$(253,112)
Total Source of Funds	—	\$18,560,643	\$17,735,369	\$27,293,894	\$27,293,894	\$8,733,251

Unit Description

In 1974, under President Nixon-Legacy of Parks program, County of Monterey acquired 542 acres from the Federal government (formerly Fort Ord land) to create the Laguna Seca Recreational Area (LSRA). A raceway existed and then a rifle range, archery range, and a motocross track were constructed to enhance facility use.

In 1981, LSRA celebrated the grand opening of an added campground, lake, and picnic areas. In FY 2020-21, LSRA was converted from the General Fund to an Enterprise fund. LSRA operates as a fee-for-service enterprise. Services include camping, daily track rentals, venue rentals, corporate team-building packages, and ticket sales to various special events. Special events range from small local gatherings to international events known worldwide. The earnings of LSRA are intended to sustain its operations including financing all costs associated with capital improvement projects,

depreciation, and all County cost allocations. Operations are currently managed by a private contractor.

Recommended FY 2023-24 Positions

Classification Code	Classification Label	FTE
14C31	MANAGEMENT ANALYST III	1.00
14G02	MANAGEMENT ANALYST I	1.00
14N05	ADMINISTRATIVE OPERATIONS MANAGER	1.00
20B11	ACCOUNTANT II	1.00
20B12	ACCOUNTANT III	1.00
20B93	FINANCE MANAGER II	1.00
80J22	SENIOR ACCOUNT CLERK	1.00
Total		7.00

Vehicle Replacement

(Budget Unit 8580—Fund 478—Appropriation Unit PFP068)

Use of Funds

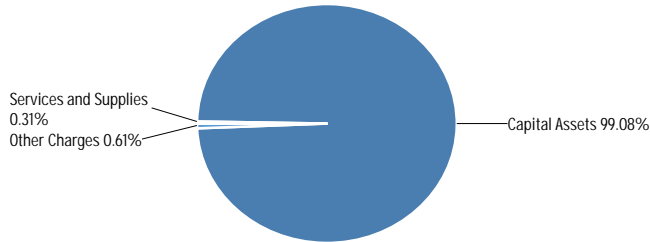

Source of Funds

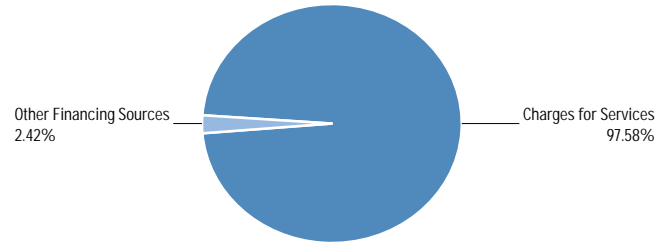

Use of Funds

Expenditures	Prior Year 2021-2022	Adopted Budget 2022-2023	CY Estimate 2022-2023	Requested Budget 2023-2024	Recommended Budget 2023-2024	Recommended Change from Adopted
Services and Supplies	—	\$21,491	\$10,018	\$11,678	\$11,678	\$(9,813)
Other Charges	—	\$10,133	\$(25,777)	\$23,151	\$23,151	\$13,018
Capital Assets	—	\$3,514,921	\$3,514,921	\$3,770,528	\$3,770,528	\$255,607
Subtotal	—	\$3,546,545	\$3,499,162	\$3,805,357	\$3,805,357	\$258,812

Source of Funds

Revenues	Prior Year 2021-2022	Adopted Budget 2022-2023	CY Estimate 2022-2023	Requested Budget 2023-2024	Recommended Budget 2023-2024	Recommended Change from Adopted
Charges for Services	—	\$3,646,664	\$4,037,831	\$3,985,844	\$3,985,844	\$339,180
Other Financing Sources	—	\$222,072	\$102,420	\$98,840	\$98,840	\$(123,232)
Subtotal	—	\$3,868,736	\$4,140,251	\$4,084,684	\$4,084,684	\$215,948
Fund Balance	—	\$(322,191)	\$(641,089)	\$(279,327)	\$(279,327)	\$42,864
Total Source of Funds	—	\$3,546,545	\$3,499,162	\$3,805,357	\$3,805,357	\$258,812

Unit Description

Under the Vehicle Asset Replacement Management Program, participating departments are charged a monthly future replacement

fee during the useful life of the vehicle. These funds are then used to replace the vehicle after it has been fully depreciated, typically for six to eight years.

Health

Departmental Overview:

Monterey County Health Department is responsible for protecting the health and wellbeing of the community and safeguarding our environment. To meet this responsibility, the Health Department collaborates with partners and community residents to improve health and racial equity; enforces laws and regulations to protect the public's health; and offers behavioral health, primary and specialty health care services, and public health education, prevention, and control services.

Programs and Functions:

The Health Department is organized into eight (8) operational bureaus/divisions. The Administration Bureau provides infrastructure and support services and leads Health in All Policies efforts. The Animal Services Division provides sheltering and rabies control and prevention services. The Behavioral Health Bureau provides mental health and substance use disorder services to County residents. The Clinic Services Bureau provides comprehensive primary medical care, obstetrics, internal medicine, low acuity behavioral health, and communicable disease prevention services to all County residents. The Environmental Health Bureau safeguards the health and safety of residents by way of education and enforcement of federal, state, and local environmental statutes. Emergency Medical Services (EMS) plans, coordinates, and evaluates the countywide EMS system. The Public Health Bureau registers births and deaths, provides laboratory analyses, coordinates care services to children and families, implements strategies for the prevention and control of communicable diseases, and implements programs that inform and educate individuals and communities to reduce health inequities. The Public Guardian/Administrator serves as the court-appointed responsible party for vulnerable individuals unable or unwilling to meet their medical, housing, clothing, and physical needs.

Department's Contributions to Monterey County's Strategic Initiatives:

ECONOMIC DEVELOPMENT

Encouraging municipalities to consider health equity and "Health in All Policies" in future community development plans.

ADMINISTRATION

Conducting ongoing quality improvement activities; using customer satisfaction survey results to improve public services.

HEALTH AND HUMAN SERVICES

Ensuring equitable access to physical and emotional health services and working with community partners to address the root causes of health disparities.

INFRASTRUCTURE

Assuring well water, stream, and beach water quality through ongoing testing and public information announcements.

PUBLIC SAFETY

Promoting protective factors against violence; advocating for the use of safety equipment and safe routes to school; assuring timely and appropriate pre-hospital transportation; and responding to disasters.



Operating Budget: \$370,806,768
Positions (FTEs): 1,271.30

Elsa Mendoza Jimenez
Director

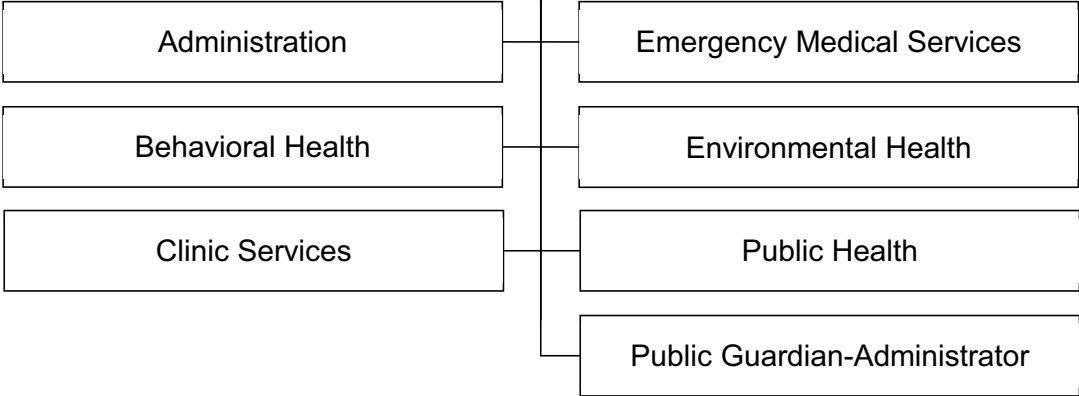

Staffing Trends

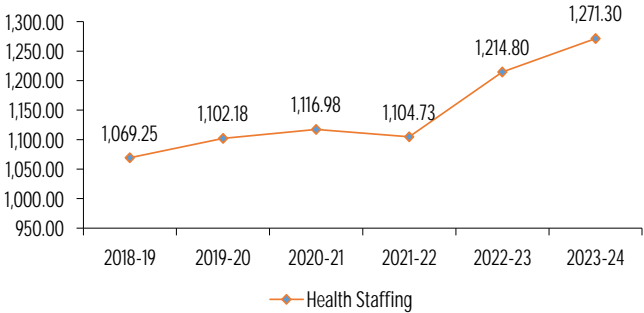

Expenditure/Revenue History (in millions)

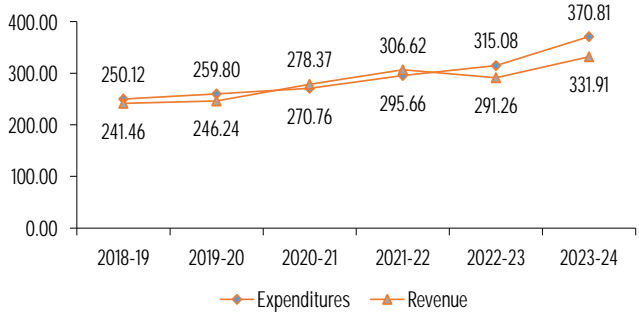

The Health Department protects the health of our entire community by offering primary, specialty, and mental health care, health education, enforcing laws and regulations to protect health and our environment, and by collaborating with partners to improve health equity. *The State transitioned the WIC program to new software. Staff is unable to extra the data for this measure. Staff is working with the State to address the issue. ** Per COVID-19 restrictions, visits had been virtual.

Key Performance Measures	2020-21 Actual	2021-22 Actual	2022-23 Mid-Year
Inspections of high risk food facilities. Target > 108	93	56	91
Decreased re-hospitalization of behavioral health clients within 30 days of discharge. Target > 17%	11%	17%	13%
Youth ages 3-17 with clinic-measured body mass calculations in the prior 6 months. Target > 90%	60.0%	51.4%	51.1%
Children ages 2-5 enrolled in WIC who are at-risk for overweight. Target < 18%*	22%	*	*
WIC-enrolled mothers providing any breastfeeding at 6 months. Target > 43%	43.8%	46.6%	54.1%
Public Guardian onsite visits with clients at least once per quarter. Target = 100%**	100%	97%	88%

Use of Funds

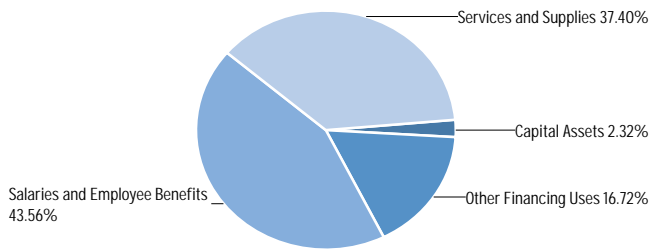

Source of Funds

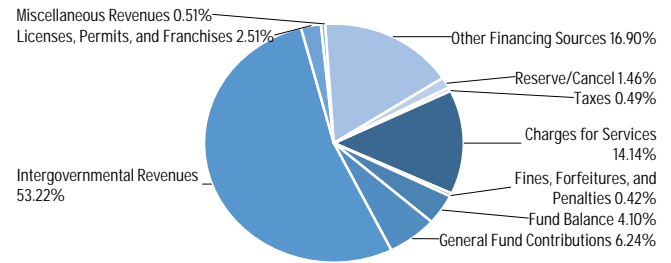

Use of Funds

Expenditures	Prior Year 2021-2022	Adopted Budget 2022-2023	CY Estimate 2022-2023	Requested Budget 2023-2024	Recommended Budget 2023-2024	Recommended Change from Adopted
Salaries and Employee Benefits	\$127,488,261	\$164,579,401	\$140,422,864	\$163,613,218	\$163,613,218	\$(966,183)
Services and Supplies	\$114,223,038	\$139,346,028	\$122,900,881	\$142,209,132	\$140,475,006	\$1,128,978
Other Charges	\$4,478,104	\$(969,608)	\$(2,886,125)	\$(4,802,418)	\$(4,802,418)	\$(3,832,810)
Capital Assets	\$3,019,197	\$3,441,376	\$8,637,274	\$9,484,077	\$8,709,102	\$5,267,726
Other Financing Uses	\$46,456,019	\$48,942,860	\$46,000,212	\$62,811,860	\$62,811,860	\$13,869,000
Subtotal	\$295,664,619	\$355,340,057	\$315,075,106	\$373,315,869	\$370,806,768	\$15,466,711

Source of Funds

Revenues	Prior Year 2021-2022	Adopted Budget 2022-2023	CY Estimate 2022-2023	Requested Budget 2023-2024	Recommended Budget 2023-2024	Recommended Change from Adopted
Taxes	\$1,839,057	\$1,800,000	\$1,835,000	\$1,835,000	\$1,835,000	\$35,000
Licenses, Permits, and Franchises	\$7,162,599	\$8,535,500	\$7,980,233	\$9,434,479	\$9,434,479	\$898,979
Fines, Forfeitures, and Penalties	\$1,737,327	\$1,744,439	\$1,260,413	\$1,582,913	\$1,582,913	\$(161,526)
Revenue from Use of Money & Property	\$276,372	\$299,390	\$287,390	\$279,483	\$279,483	\$(19,907)
Intergovernmental Revenues	\$205,868,272	\$199,078,986	\$175,642,065	\$200,110,473	\$200,110,473	\$1,031,487
Charges for Services	\$44,072,249	\$54,106,599	\$48,729,985	\$53,174,321	\$53,174,321	\$(932,278)
Miscellaneous Revenues	\$1,971,741	\$1,710,220	\$1,705,682	\$2,030,000	\$1,934,000	\$223,780
Other Financing Sources	\$43,687,536	\$53,284,347	\$53,820,471	\$63,560,875	\$63,560,875	\$10,276,528
Subtotal	\$306,615,153	\$320,559,481	\$291,261,239	\$332,007,544	\$331,911,544	\$11,352,063
Other Funds - Fund Balance	\$(30,747,933)	\$7,997,395	\$313,493	\$15,420,874	\$15,420,874	\$7,423,479
General Fund Contributions	\$19,797,399	\$26,783,181	\$23,500,374	\$20,394,198	\$17,981,097	\$(8,802,084)
General Fund - Restricted Fund Balance	—	—	—	\$5,493,253	\$5,493,253	\$5,493,253
Total Source of Funds	\$295,664,619	\$355,340,057	\$315,075,106	\$373,315,869	\$370,806,768	\$15,466,711

Summary of Recommendation

The Recommended Budget for the Health Department includes appropriations of \$370,806,768, financed by revenues of \$331,944,544, departmental fund balance of \$15,420,874 (Behavioral Health \$3.03 million, Whole Person Care \$3.82 million, Health Realignment \$8.13 million, CSA 74 \$472,495, and \$40,000 EMS), general fund contribution (GFC) of \$17,981,097 (including American Rescue Plan Act (ARPA) funds of \$483,149), and departmental restricted fund use of \$5,493,253 (\$5,271,839 Clinic Services and \$221,414 Environmental Health). Appropriation and revenue levels are respectively \$15,466,711 and \$11,352,063, higher than the Fiscal Year (FY) 2022-23 Adopted Budget. The increase in appropriations is driven primarily by program growth in the Behavioral Health and Public Health Bureaus (\$9.4 million and \$6 million, respectively) to

meet demand for services, with corresponding increases in program revenues.

The Recommended Budget includes 34 augmentations adding 42 new positions as follows: six (6) positions in the Administration Bureau (Building Maintenance Supervisor, Management Analyst II, Office Assistant III, 2 Community Service Aide III, Accounting-Clerical Supervisor); 13 positions in the Clinic Services Bureau (Assistant Bureau Chief, Departmental Information Systems Coordinator, Management Analyst II, 8 Health Education Assistant, Clinic Operations Supervisor, Departmental Information Systems Specialist); four (4) new positions in the Public Health Bureau (Sr. Therapist Physically Handicapped Children, Public Health Nutritionist II, Community Service Aide IV, Chronic Disease Prevention Specialist II); two (2) positions in the Animal Services

Division (Veterinary and Registered Veterinary Technician); and 17 positions in the Behavioral Health Bureau (Registered Chronic Disease Prevention Coordinator, Sr. Psychiatric Social Worker, Social Worker III, 8 Medical Assistant, 3 Patient Services Representative II, 2 Clinic Operations Supervisor, Medical Records Technician), all funded with Department revenues.

The Recommended Budget also includes augmentations for professional services in support of the Sexual Assault Response Team (SART) program (\$266,000) financed by the General Fund; participatory budget process (\$550,000) funded with Health Realignment; hygienic program (\$60,000) funded with Department revenue; Farmworker Resource Center (\$208,250) from cannabis assignment carryover from FY 2022-23; and violence prevention efforts (\$483,149) ARPA (carryover funding from FY 2022-23 of \$164,954, and the FY 2023-24 allocation of \$318,195).

Budget Impacts

The Recommended Budget does not include augmentations for: the Cannabis Education Program (\$225,000); camera equipment and professional services for the illegal dumping pilot project (\$8,000 and \$120,000, respectively); mobile spay/neuter clinics (\$144,000); Employee Wellness Program programming and equipment replacement (\$183,126 and \$83,000 respectively); animal shelter feasibility study (\$774,975); and funding for First 5 and Bright Beginning initiatives for community outreach and advocacy (\$225,000), investment in Informal Child Caregiver Network (\$300,000), and implementation of a career pathway program for early educators (\$350,000).

Prior Year Accomplishments

With the COVID-19 response entering into a new phase of mitigation and management, Health Department Bureaus and Divisions have generally pivoted to their previous, pre-pandemic programmatic activities. In addition to this return, the Department has also redeployed resources as part of the County's disaster response necessitated by the 2023 winter extreme weather events. Accordingly, although significant progress was made towards the goals set for the budget year, several were not fully realized, as reflected on the itemized listing below. As programmatic activities continue to normalize in the coming fiscal year, the Department anticipates the goals set will be met.

Completed 61.1% of employee annual performance appraisals on or before anniversary dates.

No Plan, Do, Study, Act (PDSA) exercises for programs serving vulnerable populations have been conducted as staff has been engaged winding down their role in COVID-19 response activities and assisting with winter weather events disaster response.

Surpassed goal of having less than 17% of mental health clients re-hospitalized within 30 days from release by achieving a rate of 13%.

Sustained equitable Behavioral Health access to services for new and existing clients by focusing on underserved County regions in proportion to the regions in which Medi-Cal recipients reside; Coast Goal: 14% Actual: 21%, North Goal: 11% Actual: 10%, Valley Goal: 50% Actual: 48%, South Goal: 20% Actual: 19%, and Other Goal: 5% Actual: 2%.

Moderate progress was made on the goal to aid more than 70% of Primary Care Services diabetic patients to have Hemoglobin A1c levels of less than 9. The actual rate achieved was 45.5%.

The goal to help more than 64% of Primary Care Services patients with hypertension to have systolic blood pressure measurement less than 140 mm Hg and diastolic blood pressure less than 90 mm Hg was nearly met, achieving an actual rate of 61.5%.

Conducted annual inspection of 84% of current permitted high-risk food facilities; the goal was 100%.

On track to meet the goal to collect 18,000 pounds of recyclables/solid waste from beaches, agricultural lands, and open spaces.

96% of urgent Public Guardian client's safety needs were addressed within five days of court appointment compared to a goal of 100%.

Surpassed the goal to encourage more than 37% of Women Infants Children (WIC) infant beneficiaries to receive breastfeeding at 12 months, achieving a rate of 45.3%.

Unable to report progress on the goal to work with WIC beneficiaries ages 2 to 5 years to strive for less than 20% to be considered overweight or at risk of overweight, as data from the state has not been available. If the issue cannot be resolved, an alternative measure will be implemented.

Surpassed the goal to aid at least 90% of teen girls enrolled in the postpone peer education training program to complete course achieving an actual rate of 162%.

The goal to respond to infectious disease reports within Centers for Disease Control and Prevention and the California Department of Public Health recommended timeframes more than 85% of the time was not met as the data was not tracked or reported due to being engaged on COVID-19 pandemic response activities.

Budget Year Goals

Sustain equitable Behavioral Health access to services for new and existing clients by focusing on underserved County regions in proportion to the regions in which Medi-Cal recipients reside; Coast 14%, North 1%, Valley 50%, South 20%, and Other 5%.

Complete 90% of employee annual performance appraisals on or before anniversary dates.

Conduct 14 Plan, Do, Study, Act (PDSA) exercises for programs serving vulnerable populations.

Establish that less than 17% of mental health clients are re-hospitalized within 30 days.

Aid more than 70% of Primary Care Services diabetic patients to have Hemoglobin A1c levels of less than 9.

Help more than 64% of Primary Care Services patients with hypertension to have systolic blood pressure measurement less than 140 mm Hg and diastolic blood pressure less than 90 mm Hg.

Conduct annual inspection of 100% of current permitted high-risk food facilities.

Collect 18,000 pounds of recyclables/solid waste from beaches, agricultural lands, and open spaces.

Ensure that 100% of urgent Public Guardian client's safety needs are addressed within five days of court appointment.

Encourage more than 37% of WIC infant beneficiaries to receive breastfeeding at 12 months.

Work with WIC beneficiaries ages 2 to 5 years to strive for less than 20% to be considered overweight or at risk of being overweight.

Aid at least 90% of teen girls enrolled in the postponed peer education training program to complete the course.

Respond to infectious disease reports within the Centers for Disease Control and Prevention and the California Department of Public Health recommended timeframes more than 85% of the time.

Pending Issues

The Clinic Services Bureau had more than 45,000 patients assigned per month in FY 2021-22. Provider recruitment and retention is a concern for the healthcare industry. Losing providers presents challenges in providing timely patient care, maintaining quality of care, reducing staff burnout, and maintaining financial sustainability. Shortage of primary care providers in the region results in high demand of primary care providers, which creates competitive markets. Retaining and recruiting providers will remain a challenge in subsequent FYs. Review of provider compensation and alternative venues will be necessary to retain current providers and recruit new providers needed for patient care. Clinic Services is participating in the National Health Service Corp (NHSC) Loan Repayment Program as a new means to attract providers.

The Department of Health Care Services (DHCS) submitted State Plan Amendment 18-003 to the Center for Medicare and Medicaid Services. It included a few proposals pertinent to Federally Qualified Health Centers (FQHC), such as, adding marriage and family therapists (MFT) as a new FQHC billable provider, reducing minimum productivity standards used in the rate setting process, and an alternative payment method (APM) pilot program to reform payment and service delivery modules. The APM would replace the traditional Fee for Service, per visit payment model where payment is contingent on a face-to-face visit with a medical provider. DHCS will launch an APM pilot program on January 1, 2024, and Clinic Services was selected as a participant. Additionally, DHCS approved Community Health Workers as new billable providers starting FY 2022-23. The Clinic Services FY 2023-24 Recommended Budget includes new positions, which will function as Community Health Workers and will provide direct services to eligible beneficiaries.

The State launched the California Advancing and Innovating Medi-Cal (CalAIM) initiative in January of 2022. CalAIM seeks to move Medi-Cal to a population health approach, which prioritizes prevention and whole person care and provides supports beyond those available in traditional medical settings. CalAIM seeks to address social drivers of health and offer beneficiaries coordinated and equitable access to services. This will be achieved through various strategies and interventions, including Enhanced Care Management (ECM), which is provided to beneficiaries with the highest needs. Having participated in the Whole Person Care demonstration project, the Health Department transitioned to a provider of ECM services. The Health Department executed an agreement with the Central California Alliance for Health (CCAH), a managed care provider,

effective January of 2022 and continues to accept client referrals from CCAH. The ECM program is administered by the Public Health Bureau. CalAIM will be implemented in a three-phase approach, transitioning one population of focus at a time, which began in January 2022 with individuals and families experiencing homelessness, high-utilizer adults, and adults with severe mental illness and/or substance use disorders. The next population of focus was introduced on January 1, 2023, and is comprised of adults, children, and youth transitioning from incarceration, eligible for long-term-care, and at risk of institutionalization, as well as nursing facility residents wishing to transition to the community. The third and last population of focus will be introduced on July 1, 2023 and is comprised of children and youth who are high-utilizers, with severe emotional disturbance (SED), enrolled in California Children Services (CCS) with needs beyond CCS, and a history of involvement with child welfare.

The Office of the Inspector General (OIG) conducted a state audit of the Specialty Mental Health Medi-Cal claims for FY 2013-14, which resulted in a statewide recoupment of \$180.7 million. Monterey County's portion of the payment is \$2.5 million that are to be offset from Vehicle License Fee revenue over four fiscal years. The first offset occurred in FY 2018-19. During FY 2019-20, due to the onset of the COVID-19 pandemic and the downward fiscal outlook, the State paused recoupments. As anticipated, the State endeavored to restart recoupment during FY 2021-22. Although there were advocacy efforts for the State to settle the recoupment with State funds, they were unsuccessful. Accordingly, recoupment of Monterey County's unpaid balance of \$1.8 million commenced in FY 2019-22, with a second offset in the amount of \$623,749; the two remaining offsets are planned for FY 2022-23 and FY 2023-24, respectively.

Due to the implementation of AB 85, approximately \$6 million in local health revenues in future years will be redirected to the State annually. In FY 2018-19, the Board approved a three-year plan that used a realignment fund balance to minimize the impact to services. Through prudent decision-making and management, the three-year plan has outperformed initial estimates, and consequently, the realignment fund balance continues to be used strategically to minimize impacts to services. If AB 85 redirection continues, the Department may face budgetary challenges in future years. AB 85 developments continue to be monitored.

In FY 2020-21, a second Request-for-Proposals for a new ambulance contract was released but no bids were received. The EMSA will explore options to ensure that its exclusive operating area is maintained, and that higher level of emergency medical services are delivered in a more equitable manner.

Implementation of Salinas Valley Basin Groundwater Sustainability Agency (SBVGSA) Groundwater Sustainability Plan will require a review and update to Environmental Health's role in the permitting of drinking water; and agricultural well construction, destruction and monitoring.

The work of the Animal Services Division and the City of Salinas toward the consolidation of animal services culminated with the establishment of a Joint Powers Agreement (JPA), which became effective January 1, 2023, with the County of Monterey and the City of Salinas as the lead agencies. The Board of Directors of the newly formed JPA, with representation from the lead agencies, will continue to work on refining details of shelter operations and establishing cost and revenue sharing methodologies. Any resulting impacts to the Animal Services Division's budget from its membership in the JPA would be brought to the Board for consideration and approval.

The enactment of Senate Bill (SB) 317, Competent to Stand Trial, has further increased referrals for services to the Public Conservator. Penal Code 1370 cases, as they are known, are the most complex and result in staff needing to have smaller assigned caseloads to better support these individuals who are deemed mentally incompetent with complex needs. Referrals come from many sources, including hospitals, courts, jails, adult protective services, etc., and the Public Conservator may not have sufficient capacity to meet increased demands for its services while assuring delivery of effective, quality conservator services to Monterey County’s most vulnerable adult population. The Public Guardian Division will continue to monitor the increased workload, reassess and bring forth to the Board for consideration and approval request for additional resources.

SB 184 authorizes DHCS to transfer the Child Health and Disability Prevention (CHDP) functions to local Medi-Cal Managed Care Plans effective July 1, 2024, and eliminate CHDP allocations to counties in the FY 2024-25 budget. The Healthcare Program for Children in Foster Care (HCPCFC) will transition to a stand-alone program. The Health Department will continue to engage with DHCS and Central California Alliance for Health (CCAH) to prepare for these transitions.

Policy Considerations

The continued implementation of Short-Lived Climate Pollutants (Organics Recycling), SB 1383, will require the Environmental Health Bureau to develop Board approved resources and coordinative efforts among other key agencies and entities, which may increase notice of violations and potentially cost reimbursement in future fiscal years.

AB 626 established a new type of retail food facility, Micro Enterprise Home Kitchen Operation (MEHKO), where retail food activities can now be permitted to operate out of a personal home kitchen. The Board will have the option for the County to opt in or opt

out of this program. Opting in will require more resources to ensure proper implementation of health requirements.

The Environmental Health Bureau will continue to submit annual fee adjustments of health permits and services for the Board’s consideration and approval. Such annual adjustments are needed to keep pace with the rising costs of providing services.

County and local municipality ordinances regulating the sale, manufacturing, and distribution of Adult-Use Marijuana will continue to have significant impacts on workloads and require collaboration with law enforcement to address illegal operations throughout the Monterey County. The Department will need a new, dedicated funding source to comply with local and State requirements for commercial, medical, and recreational cannabis use.

The COVID-19 health emergency exposed inadequate local systems and resources brought about by years of underinvestment in core Public Health functions, including communicable disease prevention and control, data surveillance, and the Public Health laboratory. As part of the response efforts, the Federal Government made one-time funding available for Public Health, which has helped prop up temporary infrastructure. In FY 2022-23 the State Budget allocated \$200.4 million in Future of Public Health (FoPH) funding. FoPH is an ongoing funding source that is intended for investments in public health workforce and infrastructure. The Department’s annual allocation is \$2.5 million. Locally, the FoPH allocation allowed for a modest investment in public health workforce; however, further ongoing investments will be required to assure local health departments are adequately prepared and resourced to meet their communities’ needs and to respond to future health emergencies.

The Animal Services Division submitted augmentation requests for continuation of mobile spay/neuter clinics, which in the current fiscal year has provided spay/neuter surgeries for more than 670 feral cats and owned pets.

Appropriation Expenditure Detail

	Prior Year 2021-2022	Adopted Budget 2022-2023	CY Estimate 2022-2023	Requested Budget 2023-2024	Recommended Budget 2023-2024	Recommended Change from Adopted	Fund Code	Budget Unit Code
Clinic Services Administration (HEA007)	11,191,002	12,385,370	11,933,164	0	0	(12,385,370)	001	8096
Alisal Health Center (HEA007)	8,843,961	12,550,605	10,512,505	0	0	(12,550,605)	001	8097
Clinic Services NIDO clinic (HEA007)	997,220	1,399,937	1,165,931	0	0	(1,399,937)	001	8098
Laurel Family Practice (HEA007)	6,946,905	7,728,044	6,555,353	0	0	(7,728,044)	001	8099
Laurel Internal Medicine (HEA007)	4,962,667	7,088,810	4,680,758	0	0	(7,088,810)	001	8100
Laurel Pediatrics (HEA007)	6,248,143	8,491,530	6,892,822	0	0	(8,491,530)	001	8101
Marina Health Center (HEA007)	1,886,435	2,344,619	1,921,571	0	0	(2,344,619)	001	8103
Public Health (HEA007)	1,953	0	0	0	0	0	001	8104
Seaside Family Health Center (HEA007)	9,390,693	12,242,824	9,443,134	0	0	(12,242,824)	001	8105
Ambulance Service (HEA010)	1,761,742	2,198,103	2,119,072	2,337,495	2,337,495	139,392	092	8108
EMS Operating (HEA006)	437,101	319,694	468,694	247,131	247,131	(72,563)	001	8109
Uncompensated Care (HEA009)	403,045	603,000	621,889	708,900	708,900	105,900	016	8111
Consumer Health Protection Services (HEA005)	3,460,190	4,768,458	4,340,269	4,821,612	4,821,612	53,154	001	8112
Recycling and Resource Recovery Services (HEA005)	973,507	1,006,418	1,023,796	1,084,555	1,084,555	78,137	001	8113

Appropriation Expenditure Detail

	Prior Year 2021-2022	Adopted Budget 2022-2023	CY Estimate 2022-2023	Requested Budget 2023-2024	Recommended Budget 2023-2024	Recommended Change from Adopted	Fund Code	Budget Unit Code
Land Use (HEA005)	862,363	1,179,315	1,082,506	1,077,038	1,077,038	(102,277)	001	8115
Hazardous Materials & Solid Waste Management (HEA005)	3,223,281	3,833,921	3,349,087	3,972,279	3,844,279	10,358	001	8116
Environmental Health Fiscal and Administration (HEA005)	228,317	51,126	58,394	(264,056)	(264,056)	(315,182)	001	8117
Public Guardian/Administrator/ Conservator (HEA008)	2,477,285	3,100,211	3,065,964	3,267,589	3,267,589	167,378	001	8118
Children's Medical Services (HEA004)	4,659,804	5,176,413	4,957,463	5,245,728	5,245,728	69,315	001	8121
Community Health Regional Teams (HEA003)	1,669,161	2,254,675	1,973,562	2,376,812	2,376,812	122,137	001	8123
Public Health (HEA003)	26,168,736	43,695,737	31,897,814	44,638,327	43,272,201	(423,536)	001	8124
Drinking Water Protection (HEA005)	1,520,024	2,200,218	2,005,900	2,469,032	2,469,032	268,814	001	8272
Behavioral Health (HEA002)	0	0	0	333,102	333,102	333,102	023	8410
Behavioral Health (HEA012)	136,554,068	153,098,344	142,654,042	162,221,338	162,221,338	9,122,994	023	8410
Behavioral Health (HEA015)	17,660,926	21,764,942	21,764,942	29,305,772	29,305,772	7,540,830	022	8410
Behavioral Health (HEA016)	10,300,720	10,301,721	10,301,721	10,301,721	10,301,721	0	025	8410
Health Realignment (HEA013)	8,752,542	12,575,837	12,575,837	19,379,367	19,379,367	6,803,530	025	8424
Health Dept. Administration (HEA014)	8,093,009	8,509,804	7,328,259	6,677,511	6,677,511	(1,832,293)	001	8438
Animal Services (HEA001)	3,419,713	4,825,854	4,832,657	6,203,576	5,188,601	362,747	001	8442
Bienestar Salinas (HEA007)	76,226	112,263	117,443	0	0	(112,263)	001	8446
Marina Integrative Clinic (HEA007)	93,138	221,834	119,105	0	0	(221,834)	001	8447
Laurel Vista (HEA007)	869,416	1,452,818	898,621	0	0	(1,452,818)	001	8448
Clinic Services Quality Improvement (HEA007)	1,123,741	1,741,948	1,381,457	0	0	(1,741,948)	001	8449
Customer Service Center (HEA007)	1,297,870	1,815,304	1,673,662	0	0	(1,815,304)	001	8450
Whole Person Care (HEA017)	9,109,716	4,300,360	1,357,712	3,825,000	3,825,000	(475,360)	023	8473
CS Administration (HEA007)	0	0	0	16,377,804	16,377,804	16,377,804	001	8591
FQHC Clinics (HEA007)	0	0	0	46,708,236	46,708,236	46,708,236	001	8592
Subtotal	\$295,664,619	\$355,340,057	\$315,075,106	\$373,315,869	\$370,806,768	\$15,466,711		

Budget Units

	Prior Year 2021-2022	Adopted Budget 2022-2023	CY Estimate 2022-2023	Requested Budget 2023-2024	Recommended Budget 2023-2024	Recommended Change from Adopted
Clinic Services Administration	\$11,191,002	\$12,385,370	\$11,933,164	—	—	\$(12,385,370)
Alisal Health Center	\$8,843,961	\$12,550,605	\$10,512,505	—	—	\$(12,550,605)
Clinic Services NIDO clinic	\$997,220	\$1,399,937	\$1,165,931	—	—	\$(1,399,937)
Laurel Family Practice	\$6,946,905	\$7,728,044	\$6,555,353	—	—	\$(7,728,044)
Laurel Internal Medicine	\$4,962,667	\$7,088,810	\$4,680,758	—	—	\$(7,088,810)
Laurel Pediatrics	\$6,248,143	\$8,491,530	\$6,892,822	—	—	\$(8,491,530)
Marina Health Center	\$1,886,435	\$2,344,619	\$1,921,571	—	—	\$(2,344,619)
Public Health	\$1,953	—	—	—	—	—
Seaside Family Health Center	\$9,390,693	\$12,242,824	\$9,443,134	—	—	\$(12,242,824)
Ambulance Service	\$1,761,742	\$2,198,103	\$2,119,072	\$2,337,495	2,337,495	\$139,392
EMS Operating	\$437,101	\$319,694	\$468,694	\$247,131	247,131	\$(72,563)
Uncompensated Care	\$403,045	\$603,000	\$621,889	\$708,900	708,900	\$105,900
Consumer Health Protection Services	\$3,460,190	\$4,768,458	\$4,340,269	\$4,821,612	4,821,612	\$53,154

Budget Units

	Prior Year 2021-2022	Adopted Budget 2022-2023	CY Estimate 2022-2023	Requested Budget 2023-2024	Recommended Budget 2023-2024	Recommended Change from Adopted
Recycling and Resource Recovery Services	\$973,507	\$1,006,418	\$1,023,796	\$1,084,555	1,084,555	\$78,137
Land Use	\$862,363	\$1,179,315	\$1,082,506	\$1,077,038	1,077,038	\$(102,277)
Hazardous Materials & Solid Waste Management	\$3,223,281	\$3,833,921	\$3,349,087	\$3,972,279	3,844,279	\$10,358
Environmental Health Fiscal and Administration	\$228,317	\$51,126	\$58,394	\$(264,056)	(264,056)	\$(315,182)
Public Guardian/Administrator/Conservator	\$2,477,285	\$3,100,211	\$3,065,964	\$3,267,589	3,267,589	\$167,378
Children's Medical Services	\$4,659,804	\$5,176,413	\$4,957,463	\$5,245,728	5,245,728	\$69,315
Community Health Regional Teams	\$1,669,161	\$2,254,675	\$1,973,562	\$2,376,812	2,376,812	\$122,137
Public Health	\$26,168,736	\$43,695,737	\$31,897,814	\$44,638,327	43,272,201	\$(423,536)
Drinking Water Protection	\$1,520,024	\$2,200,218	\$2,005,900	\$2,469,032	2,469,032	\$268,814
Behavioral Health	\$164,515,714	\$185,165,007	\$174,720,705	\$202,161,933	202,161,933	\$16,996,926
Health Realignment	\$8,752,542	\$12,575,837	\$12,575,837	\$19,379,367	19,379,367	\$6,803,530
Health Dept. Administration	\$8,093,009	\$8,509,804	\$7,328,259	\$6,677,511	6,677,511	\$(1,832,293)
Animal Services	\$3,419,713	\$4,825,854	\$4,832,657	\$6,203,576	5,188,601	\$362,747
Bienestar Salinas	\$76,226	\$112,263	\$117,443	—	—	\$(112,263)
Marina Integrative Clinic	\$93,138	\$221,834	\$119,105	—	—	\$(221,834)
Laurel Vista	\$869,416	\$1,452,818	\$898,621	—	—	\$(1,452,818)
Clinic Services Quality Improvement	\$1,123,741	\$1,741,948	\$1,381,457	—	—	\$(1,741,948)
Customer Service Center	\$1,297,870	\$1,815,304	\$1,673,662	—	—	\$(1,815,304)
Whole Person Care	\$9,109,716	\$4,300,360	\$1,357,712	\$3,825,000	3,825,000	\$(475,360)
CS Administration	—	—	—	\$16,377,804	16,377,804	\$16,377,804
FQHC Clinics	—	—	—	\$46,708,236	46,708,236	\$46,708,236
Subtotal	\$295,664,619	\$355,340,057	\$315,075,106	\$373,315,869	\$370,806,768	\$15,466,711

Adopted FY 2022-23 to Recommended FY 2023-24 Positions

Classification Code	Classification Label	Adopted Budget 2021-2022	Adopted Budget 2022-2023	Recommended Budget 2023-2024	Change
11A09	DIRECTOR HEALTH SERVICES	1.00	1.00	1.00	0.00
12C05	ASSISTANT DIRECTOR OF HEALTH SERVICES	1.00	1.00	1.00	0.00
12E04	BUREAU CHIEF	5.00	5.00	5.00	0.00
14A10	PROJECT MANAGER I	1.00	1.00	1.00	0.00
14B21	ASSOCIATE PERSONNEL ANALYST	4.00	6.00	6.00	0.00
14B32	SENIOR PERSONNEL ANALYST	2.00	3.00	3.00	0.00
14B66	DEPARTMENTAL HR MANAGER	1.00	1.00	1.00	0.00
14C30	MANAGEMENT ANALYST II	14.50	19.50	24.50	5.00
14C31	MANAGEMENT ANALYST III	13.00	14.00	16.00	2.00
14C48	PUBLIC HEALTH PROGRAM MANAGER II	3.00	3.00	3.00	0.00
14C70	ADMINISTRATIVE SERVICES ASSISTANT	1.00	1.00	1.00	0.00
14C80	PUBLIC HEALTH PROGRAM MANAGER I	2.00	2.00	2.00	0.00
14G02	MANAGEMENT ANALYST I	5.00	4.00	4.00	0.00
14H03	PERSONNEL TECHNICIAN-CONFIDENTIAL	5.00	6.00	6.00	0.00
14H24	EDUCATOR AND VOLUNTEER COORDINATOR	1.00	1.00	1.00	0.00
14H66	OUTPATIENT SERVICES DIRECTOR	1.00	1.00	1.00	0.00
14K32	BEHAVIORAL HEALTH SERVICES MANAGER I	1.00	0.00	0.00	0.00
14K41	BEHAVIORAL HEALTH SERVICES MANAGER II	15.00	16.00	16.00	0.00
14K44	ASSISTANT BUREAU CHIEF	3.00	3.00	4.00	1.00
14K61	ENVIRONMENTAL HEALTH PROGRAM MANAGER	1.00	1.00	1.00	0.00

Adopted FY 2022-23 to Recommended FY 2023-24 Positions

Classification Code	Classification Label	Adopted Budget 2021-2022	Adopted Budget 2022-2023	Recommended Budget 2023-2024	Change
14N06	OPERATIONS MANAGER	2.00	2.00	2.00	0.00
14N10	OUTPATIENT SERVICES MANAGER I	4.00	4.00	4.00	0.00
14N11	OUTPATIENT SERVICES MANAGER II	4.00	4.00	4.00	0.00
16C87	BUSINESS TECHNOLOGY ANALYST II	1.00	2.00	2.00	0.00
16C88	BUSINESS TECHNOLOGY ANALYST III	2.00	2.00	2.00	0.00
16C93	BUSINESS TECHNOLOGY ANALYST IV	2.00	3.00	3.00	0.00
16F41	DEPARTMENTAL INFORMATION SYSTEMS MANAGER II	1.00	1.00	1.00	0.00
20B10	ACCOUNTANT I	2.00	3.00	3.00	0.00
20B11	ACCOUNTANT II	8.00	8.00	9.00	1.00
20B12	ACCOUNTANT III	6.00	7.00	8.00	1.00
20B93	FINANCE MANAGER II	3.00	4.00	4.00	0.00
20B94	FINANCE MANAGER III	1.00	1.00	1.00	0.00
20B95	FINANCE MANAGER I	3.00	2.00	1.00	(1.00)
25G21	CA CHILDRENS SERVICES CASE WORKER II	3.00	3.00	3.00	0.00
30J01	ENVIRONMENTAL HEALTH TECHNICIAN	0.00	0.00	1.00	1.00
30J21	ENVIRONMENTAL HEALTH SPECIALIST II	25.00	27.00	25.00	(2.00)
30J31	ENVIRONMENTAL HEALTH SPECIALIST III	17.00	17.00	17.00	0.00
30J81	RECYCLING/RESOURCE RECOVERY SPECIALIST	2.00	2.00	2.00	0.00
30J84	ENVIRONMENTAL HEALTH SPECIALIST IV	8.00	8.00	8.00	0.00
34C01	ANIMAL CONTROL OFFICER	3.00	5.00	5.00	0.00
34C02	SENIOR ANIMAL CONTROL OFFICER	1.00	1.00	1.00	0.00
34C11	ANIMAL SERVICES SUPERVISOR	2.00	2.00	2.00	0.00
34H24	DEPUTY PUBLIC ADMINISTRATOR/GUARDIAN/CONSERVATOR I	2.50	2.50	2.50	0.00
34H34	DEPUTY PUBLIC ADMINISTRATOR/GUARDIAN/CONSERVATOR II	4.00	4.00	4.00	0.00
43B02	WATER QUALITY SPECIALIST	1.00	1.00	1.00	0.00
43J04	DEPARTMENTAL INFORMATION SYSTEMS SPECIALIST	9.00	9.00	10.00	1.00
43J05	DEPARTMENTAL INFORMATION SYSTEMS COORDINATOR	6.00	6.00	7.00	1.00
43J09	SENIOR DEPARTMENTAL INFORMATION SYSTEMS COORDINATOR	2.00	2.00	2.00	0.00
43J15	SUPERVISING DEPARTMENTAL INFORMATION SYSTEMS COORDINATOR	1.00	2.00	2.00	0.00
50B12	EMERGENCY MEDICAL SERVICES ANALYST	4.00	4.00	4.00	0.00
50C22	PUBLIC HEALTH MICROBIOLOGIST II	3.00	3.00	3.00	0.00
50C23	SENIOR PUBLIC HEALTH MICROBIOLOGIST	1.00	1.00	1.00	0.00
50C70	ASSISTANT DIRECTOR - PUBLIC HEALTH LABORATORY	1.00	1.00	1.00	0.00
50C80	DIRECTOR PUBLIC HEALTH LABORATORY	1.00	1.00	1.00	0.00
50C81	PUBLIC HEALTH CHEMIST	1.00	1.00	1.00	0.00
50E23	LABORATORY ASSISTANT	3.00	3.00	3.00	0.00
50F20	OCCUPATIONAL THERAPIST	1.00	1.00	1.00	0.00
50F23	OCCUPATIONAL THERAPIST-PHYSICALLY HANDICAPPED CHILDREN	3.40	3.40	3.40	0.00
50G23	PHYSICAL THERAPIST-PHYSICALLY HANDICAPPED CHILDREN	3.65	3.65	3.65	0.00
50G25	SENIOR THERAPIST-PHYSICALLY HANDICAPPED CHILDREN	0.80	0.80	1.80	1.00
50G31	SUPERVISING THERAPIST-MED THER PROG	1.00	1.00	1.00	0.00
50J01	CHRONIC DISEASE PREVENTION SPECIALIST I	24.00	24.00	24.00	0.00
50J11	CHRONIC DISEASE PREVENTION SPECIALIST II	9.00	10.00	13.00	3.00
50J21	CHRONIC DISEASE PREVENTION COORDINATOR	12.00	14.00	16.00	2.00
50K18	HEALTH PROGRAM COORDINATOR	6.00	6.00	5.00	(1.00)
50K19	HEALTH EDUCATION ASSISTANT	7.00	7.00	14.00	7.00
50K22	HEALTH EDUCATOR	1.00	1.00	0.00	(1.00)
50K23	SENIOR HEALTH EDUCATOR	2.00	2.00	1.00	(1.00)
50L22	PUBLIC HEALTH NUTRITIONIST II	3.00	3.00	4.00	1.00
50L80	SUPERVISING PUBLIC HEALTH NUTRITIONIST	3.00	3.00	3.00	0.00

Health

Adopted FY 2022-23 to Recommended FY 2023-24 Positions

Classification Code	Classification Label	Adopted Budget	Adopted Budget	Recommended Budget	Change
		2021-2022	2022-2023	2023-2024	
50M21	REGISTERED VETERINARY TECHNICIAN	1.00	1.00	1.50	0.50
50M80	VETERINARIAN	1.00	1.00	1.50	0.50
50N11	PUBLIC HEALTH EPIDEMIOLOGIST II	5.00	4.00	5.00	1.00
50N22	SUPERVISING PUBLIC HEALTH EPIDEMIOLOGIST	1.00	2.00	2.00	0.00
50T01	MEDICAL RECORD TECHNICIAN I	1.00	1.00	2.00	1.00
50U16	BEHAVIORAL HEALTH AIDE	20.03	25.10	25.10	0.00
50U42	MEDICAL ASSISTANT	157.00	168.00	176.00	8.00
52A21	CLINIC NURSE	1.00	1.00	1.00	0.00
52A22	SENIOR CLINIC NURSE	9.00	10.00	9.00	(1.00)
52A83	SUPERVISING CLINIC NURSE	0.00	0.00	1.00	1.00
52A94	PSYCHIATRIC NURSE PRACTITIONER	3.00	3.00	3.00	0.00
52A97	CLINIC NURSE PRACTITIONER	9.00	9.00	9.00	0.00
52E01	PUBLIC HEALTH LICENSED VOCATIONAL NURSE	8.00	21.00	21.00	0.00
52E20	DIRECTOR OF PUBLIC HEALTH NURSING	1.00	1.00	1.00	0.00
52E22	PUBLIC HEALTH NURSE II	23.00	23.00	26.00	3.00
52E23	PUBLIC HEALTH NURSE III	3.00	3.00	3.00	0.00
52E80	SUPERVISING PUBLIC HEALTH NURSE	6.75	9.75	9.75	0.00
54B04	GENERAL INTERNIST	2.00	2.00	2.00	0.00
54B12	CONTRACT PHYSICIAN	44.60	44.60	45.60	1.00
54B13	CLINIC SERVICES MEDICAL DIRECTOR	1.00	1.00	1.00	0.00
54B90	CLINIC PHYSICIAN II	5.00	5.00	4.00	(1.00)
54C03	CLINIC PHYSICIAN ASSISTANT	9.00	9.00	9.00	0.00
54C05	PSYCHIATRIC PHYSICIAN ASSISTANT	2.00	2.00	2.00	0.00
60A21	CLINICAL PSYCHOLOGIST	14.50	12.50	12.00	(0.50)
60B21	PSYCHIATRIC SOCIAL WORKER II	201.00	198.00	186.00	(12.00)
60B23	BEHAVIORAL HEALTH UNIT SUPERVISOR	30.00	35.00	35.00	0.00
60B25	SENIOR PSYCHIATRIC SOCIAL WORKER	23.00	26.00	36.00	10.00
60C21	SOCIAL WORKER II	0.00	1.00	1.00	0.00
60C22	SOCIAL WORKER III	39.00	55.00	60.00	5.00
60C80	SOCIAL WORK SUPERVISOR I	0.00	1.00	1.00	0.00
60I10	DEPUTY DIRECTOR BEHAVIORAL HEALTH	3.00	5.00	4.00	(1.00)
60L01	PATIENT RIGHTS ADVOCATE	1.00	1.00	1.00	0.00
60P21	COMMUNITY SERVICE AIDE II	3.00	26.00	27.00	1.00
60P22	COMMUNITY SERVICE AIDE III	5.00	5.00	7.00	2.00
60P23	COMMUNITY SERVICE AIDE IV	3.00	3.00	4.00	1.00
60V11	BEHAVIORAL HEALTH GROUP COUNSELOR II	2.00	1.00	0.00	(1.00)
70B03	ANIMAL CARE TECHNICIAN II	6.00	7.00	7.00	0.00
70B04	SENIOR ANIMAL CARE TECHNICIAN	1.00	1.00	1.00	0.00
72A23	BUILDING MAINTENANCE WORKER	1.00	1.00	1.00	0.00
72A81	BUILDING MAINTENANCE SUPERVISOR	0.00	0.00	1.00	1.00
80A31	SECRETARY	1.00	1.00	1.00	0.00
80A32	SENIOR SECRETARY	4.00	4.00	4.00	0.00
80A99	ADMINISTRATIVE SECRETARY-CONFIDENTIAL	1.00	1.00	1.00	0.00
80E01	OFFICE ASSISTANT I	1.00	2.00	2.00	0.00
80E21	OFFICE ASSISTANT II	9.00	11.00	11.00	0.00
80E22	OFFICE ASSISTANT III	19.00	20.00	24.00	4.00
80E80	PRINCIPAL OFFICE ASSISTANT	4.00	5.00	5.00	0.00
80E82	SUPERVISING OFFICE ASSISTANT II	1.00	1.00	1.00	0.00
80E93	SUPERVISING VITAL RECORDS SPECIALIST	1.00	1.00	1.00	0.00
80J20	ACCOUNTING CLERICAL SUPERVISOR	0.00	0.00	1.00	1.00
80J22	SENIOR ACCOUNT CLERK	6.00	6.00	6.00	0.00

Adopted FY 2022-23 to Recommended FY 2023-24 Positions

Classification Code	Classification Label	Adopted Budget 2021-2022	Adopted Budget 2022-2023	Recommended Budget 2023-2024	Change
80J30	ACCOUNTING TECHNICIAN	7.00	9.00	12.00	3.00
80K20	CLINIC OFFICE SUPERVISOR	2.00	0.00	0.00	0.00
80K25	CLINIC OPERATIONS SUPERVISOR	7.00	8.00	11.00	3.00
80L02	PATIENT SERVICES REPRESENTATIVE II	74.00	76.00	81.00	5.00
80L03	SENIOR PATIENT SERVICES REPRESENTATIVE	1.00	1.00	1.00	0.00
80L04	SUPERVISING PATIENT SERVICES REPRESENTATIVE	3.00	5.00	5.00	0.00
80M02	PATIENT ACCOUNT REPRESENTATIVE II	18.00	17.00	16.00	(1.00)
80M03	SENIOR PATIENT ACCOUNT REPRESENTATIVE	0.00	1.00	2.00	1.00
80M04	SUPERVISING PATIENT ACCOUNT REPRESENTATIVE	2.00	2.00	2.00	0.00
80U21	TELEPHONE OPERATOR	1.00	1.00	1.00	0.00
Total		1,104.73	1,214.80	1,271.30	56.50

Augmentation Requests

Request Code	Request Name	Ranking Type Name	Requested Amount	Requested FTE	Recommended Budget	Recommended FTE
4000-8116-001-AUG1	EH-Cameras	New Program/Service w/ General Fund Funding	8,000	-	-	-
4000-8116-001-AUG2	EH-Pilot IDLATF	New Program/Service w/ General Fund Funding	120,000	-	-	-
4000-8121-001-AUG1	Senior Therapist - Physically Handicapped Children - MTP	Request New Position	-	1.00	-	1.00
4000-8123-001-AUG1	Public Health Nutritionist II - TCM	Request New Position	-	1.00	-	1.00
4000-8124-001-AUG1	Community Service Aide IV - DIS Grant	Request New Position	-	1.00	-	1.00
4000-8124-001-AUG10	Chronic Disease Prevention Specialist II - ATP Grant	Request New Position	-	1.00	-	1.00
4000-8124-001-AUG12	First 5 - ECE Career Pathways	New Program/Service w/ General Fund Funding	350,000	-	-	-
4000-8124-001-AUG2	First 5 - ECE Community Outreach, Inclusion and Advocacy Str	New Program/Service w/ General Fund Funding	225,000	-	-	-
4000-8124-001-AUG3	Public Health Employee Wellness Program	New Program/Service w/ General Fund Funding	183,126	-	-	-
4000-8124-001-AUG4	ARPAPR - CPTED - Rollover	New Program/Service w/ General Fund Funding	164,954	-	164,954	-
4000-8124-001-AUG5	ARPAPR - CPTED - Base	New Program/Service w/ General Fund Funding	318,195	-	318,195	-
4000-8124-001-AUG6	Public Health Cannabis Education Program	New Program/Service w/ General Fund Funding	225,000	-	-	-
4000-8124-001-AUG7	First 5 - Informal Caregiver Strategic Priorities	New Program/Service w/ General Fund Funding	300,000	-	-	-
4000-8124-001-AUG8	SART - County Services	New Program/Service w/ General Fund Funding	266,000	-	266,000	-
4000-8124-001-AUG9	Schilling Place Fitness Center - Employee Wellness Program	New Program/Service w/ General Fund Funding	83,000	-	-	-
4000-8438-001-AUG1	ADM - BMS New Position	Request New Position	-	1.00	-	1.00
4000-8438-001-AUG2	ADM - MA II New Position	Request New Position	-	1.00	-	1.00
4000-8438-001-AUG3	ADM - OA III New Position	Request New Position	-	1.00	-	1.00
4000-8438-001-AUG4	ADM - CSAIII New Position	Request New Position	-	2.00	-	2.00
4000-8438-001-AUG5	ADM - ACS New Position	Request New Position	-	1.00	-	1.00
4000-8438-001-AUG6	ADM - Farmworker Resource Center	New Program/Service w/ General Fund Funding	-	-	-	-

Augmentation Requests

4000-8438-001-AUG7	ADM - Hygienic Program	New Program/Service w/ General Fund Funding	-	-	-	-
4000-8438-001-AUG8	ADM - Participatory Budget	New Program/Service w/ Outside Funding	-	-	-	-
4000-8442-001-AUG1	ASB- RVT New Postion	Request New Position	-	0.50	-	0.50
4000-8442-001-AUG2	ASB- VET New Position	Request New Position	-	0.50	-	0.50
4000-8442-001-AUG3	ASB-Mobile Clinics	New Program/Service w/ General Fund Funding	144,000	-	-	-
4000-8442-001-AUG4	ASB - Shelter Expansion	Capital Improvements	774,975	-	-	-
4000-8591-001-AUG1	AUG-Asst Bureau Chief	Request New Position	-	1.00	-	1.00
4000-8591-001-AUG2	AUG-Dept Info Sys Coord	Request New Position	-	1.00	-	1.00
4000-8591-001-AUG3	AUG-MA II	Request New Position	-	1.00	-	1.00
4000-8591-001-AUG4	AUG-Health Ed Asst.	Request New Position	-	8.00	-	8.00
4000-8592-001-AUG1	AUG-Clinic Ops Sup	Request New Position	-	1.00	-	1.00
4000-8592-001-AUG2	AUG-Dept Info Sys Spclst	Request New Position	-	1.00	-	1.00
4000-8410-023-AUG1	AUG-Social Worker III	Request New Position	-	1.00	-	1.00
4000-8410-023-AUG10	AUG-Medical Assistant	Request New Position	-	1.00	-	1.00
4000-8410-023-AUG11	AUG-Medical Assistant	Request New Position	-	1.00	-	1.00
4000-8410-023-AUG12	AUG-Medical Assistant	Request New Position	-	1.00	-	1.00
4000-8410-023-AUG13	AUG-Medical Assistant	Request New Position	-	1.00	-	1.00
4000-8410-023-AUG14	AUG-Medical Assistant	Request New Position	-	1.00	-	1.00
4000-8410-023-AUG15	AUG-Medical Assistant	Request New Position	-	1.00	-	1.00
4000-8410-023-AUG16	AUG-Chronic Disease Prevention Coordinator	Request New Position	-	1.00	-	1.00
4000-8410-023-AUG17	AUG-Senior Psychiatric Social Worker	Request New Position	-	1.00	-	1.00
4000-8410-023-AUG2	AUG-Patient Services Representative II	Request New Position	-	1.00	-	1.00
4000-8410-023-AUG3	AUG-Patient Services Representative II	Request New Position	-	1.00	-	1.00
4000-8410-023-AUG4	AUG-Patient Services Representative II	Request New Position	-	1.00	-	1.00
4000-8410-023-AUG5	AUG-Clinic Operations Supervisor	Request New Position	-	1.00	-	1.00
4000-8410-023-AUG6	AUG-Clinic Operations Supervisor	Request New Position	-	1.00	-	1.00
4000-8410-023-AUG7	AUG-Medical Record Technician	Request New Position	-	1.00	-	1.00
4000-8410-023-AUG8	AUG-Medical Assistant	Request New Position	-	1.00	-	1.00
4000-8410-023-AUG9	AUG-Medical Assistant	Request New Position	-	1.00	-	1.00
4000-8424-025-AUG1	Public Health Nutritionist II TCM	Request New Position	76,778	-	76,778	-
4000-8424-025-AUG2	Senior Therapist - Physically Handicapped Children MTP	Request New Position	96,621	-	96,621	-
4000-8424-025-AUG3	ADM - Participatory Budget	New Program/Service w/ Outside Funding	550,000	-	550,000	-
Grand Total:			\$3,885,649	41.00	\$1,472,548	41.00

Clinic Services Administration

(Budget Unit 8096—Fund 001—Appropriation Unit HEA007)

Use of Funds	Source of Funds
Intentionally Left Blank	Intentionally Left Blank

Use of Funds

Expenditures	Prior Year 2021-2022	Adopted Budget 2022-2023	CY Estimate 2022-2023	Requested Budget 2023-2024	Recommended Budget 2023-2024	Recommended Change from Adopted
Salaries and Employee Benefits	\$2,703,501	\$3,830,550	\$3,199,276	—	—	\$(3,830,550)
Services and Supplies	\$4,234,305	\$4,939,875	\$4,616,895	—	—	\$(4,939,875)
Other Charges	\$4,253,195	\$3,614,945	\$3,986,936	—	—	\$(3,614,945)
Capital Assets	—	—	\$130,057	—	—	—
Subtotal	\$11,191,002	\$12,385,370	\$11,933,164	—	—	\$(12,385,370)

Source of Funds

Revenues	Prior Year 2021-2022	Adopted Budget 2022-2023	CY Estimate 2022-2023	Requested Budget 2023-2024	Recommended Budget 2023-2024	Recommended Change from Adopted
Intergovernmental Revenues	\$8,251,052	\$7,094,101	\$4,317,123	—	—	\$(7,094,101)
Charges for Services	\$1,626,561	\$1,306,888	\$2,871,200	—	—	\$(1,306,888)
Other Financing Sources	\$372,626	—	—	—	—	—
Subtotal	\$10,250,239	\$8,400,989	\$7,188,323	—	—	\$(8,400,989)
General Fund Contributions	\$940,763	\$3,984,381	\$4,744,841	—	—	\$(3,984,381)
Total Source of Funds	\$11,191,002	\$12,385,370	\$11,933,164	—	—	\$(12,385,370)

Unit Description

Effective Fiscal Year 2023-24, this Unit is consolidated in Unit 8591.

Alisal Health Center

(Budget Unit 8097—Fund 001—Appropriation Unit HEA007)

Use of Funds

Intentionally Left Blank

Source of Funds

Intentionally Left Blank

Use of Funds

Expenditures	Prior Year 2021-2022	Adopted Budget 2022-2023	CY Estimate 2022-2023	Requested Budget 2023-2024	Recommended Budget 2023-2024	Recommended Change from Adopted
Salaries and Employee Benefits	\$6,435,955	\$8,560,239	\$7,010,511	—	—	\$(8,560,239)
Services and Supplies	\$1,614,881	\$1,956,423	\$2,355,836	—	—	\$(1,956,423)
Other Charges	\$782,210	\$2,033,943	\$853,873	—	—	\$(2,033,943)
Capital Assets	\$10,916	—	\$292,285	—	—	—
Subtotal	\$8,843,961	\$12,550,605	\$10,512,505	—	—	\$(12,550,605)

Source of Funds

Revenues	Prior Year 2021-2022	Adopted Budget 2022-2023	CY Estimate 2022-2023	Requested Budget 2023-2024	Recommended Budget 2023-2024	Recommended Change from Adopted
Intergovernmental Revenues	\$390,565	\$270,408	\$270,408	—	—	\$(270,408)
Charges for Services	\$9,035,555	\$9,977,899	\$9,377,897	—	—	\$(9,977,899)
Miscellaneous Revenues	\$6,500	—	—	—	—	—
Other Financing Sources	\$93,133	\$44,310	\$44,310	—	—	\$(44,310)
Subtotal	\$9,525,753	\$10,292,617	\$9,692,615	—	—	\$(10,292,617)
General Fund Contributions	\$(681,792)	\$2,257,988	\$819,890	—	—	\$(2,257,988)
Total Source of Funds	\$8,843,961	\$12,550,605	\$10,512,505	—	—	\$(12,550,605)

Unit Description

Effective Fiscal Year 2023-24, this Unit is consolidated in Unit 8592.

Clinic Services NIDO clinic

(Budget Unit 8098—Fund 001—Appropriation Unit HEA007)

Use of Funds	Source of Funds
Intentionally Left Blank	Intentionally Left Blank

Use of Funds

Expenditures	Prior Year 2021-2022	Adopted Budget 2022-2023	CY Estimate 2022-2023	Requested Budget 2023-2024	Recommended Budget 2023-2024	Recommended Change from Adopted
Salaries and Employee Benefits	\$861,215	\$1,227,857	\$852,287	—	—	\$(1,227,857)
Services and Supplies	\$404,163	\$324,944	\$287,051	—	—	\$(324,944)
Other Charges	\$(268,158)	\$(152,864)	—	—	—	\$152,864
Capital Assets	—	—	\$26,593	—	—	—
Subtotal	\$997,220	\$1,399,937	\$1,165,931	—	—	\$(1,399,937)

Source of Funds

Revenues	Prior Year 2021-2022	Adopted Budget 2022-2023	CY Estimate 2022-2023	Requested Budget 2023-2024	Recommended Budget 2023-2024	Recommended Change from Adopted
Intergovernmental Revenues	\$244,611	\$316,897	\$338,144	—	—	\$(316,897)
Charges for Services	\$430,257	\$862,814	\$381,679	—	—	\$(862,814)
Subtotal	\$674,869	\$1,179,711	\$719,823	—	—	\$(1,179,711)
General Fund Contributions	\$322,351	\$220,226	\$446,108	—	—	\$(220,226)
Total Source of Funds	\$997,220	\$1,399,937	\$1,165,931	—	—	\$(1,399,937)

Unit Description

Effective Fiscal Year 2023-24, this Unit is consolidated in Unit 8592.

Laurel Family Practice

(Budget Unit 8099—Fund 001—Appropriation Unit HEA007)

Use of Funds

Intentionally Left Blank

Source of Funds

Intentionally Left Blank

Use of Funds

Expenditures	Prior Year 2021-2022	Adopted Budget 2022-2023	CY Estimate 2022-2023	Requested Budget 2023-2024	Recommended Budget 2023-2024	Recommended Change from Adopted
Salaries and Employee Benefits	\$4,138,190	\$5,450,091	\$4,610,824	—	—	\$(5,450,091)
Services and Supplies	\$2,240,932	\$2,007,496	\$1,228,517	—	—	\$(2,007,496)
Other Charges	\$567,783	\$270,457	\$413,804	—	—	\$(270,457)
Capital Assets	—	—	\$302,208	—	—	—
Subtotal	\$6,946,905	\$7,728,044	\$6,555,353	—	—	\$(7,728,044)

Source of Funds

Revenues	Prior Year 2021-2022	Adopted Budget 2022-2023	CY Estimate 2022-2023	Requested Budget 2023-2024	Recommended Budget 2023-2024	Recommended Change from Adopted
Intergovernmental Revenues	\$201,490	\$261,480	\$261,480	—	—	\$(261,480)
Charges for Services	\$5,604,997	\$7,109,589	\$7,238,889	—	—	\$(7,109,589)
Other Financing Sources	\$577,377	\$539,999	\$539,999	—	—	\$(539,999)
Subtotal	\$6,383,864	\$7,911,068	\$8,040,368	—	—	\$(7,911,068)
General Fund Contributions	\$563,041	\$(183,024)	\$(1,485,015)	—	—	\$183,024
Total Source of Funds	\$6,946,905	\$7,728,044	\$6,555,353	—	—	\$(7,728,044)

Unit Description

Effective Fiscal Year 2023-24, this Unit is consolidated in Unit 8592.

Laurel Internal Medicine

(Budget Unit 8100—Fund 001—Appropriation Unit HEA007)

Use of Funds	Source of Funds
Intentionally Left Blank	Intentionally Left Blank

Use of Funds

Expenditures	Prior Year 2021-2022	Adopted Budget 2022-2023	CY Estimate 2022-2023	Requested Budget 2023-2024	Recommended Budget 2023-2024	Recommended Change from Adopted
Salaries and Employee Benefits	\$3,421,881	\$4,889,155	\$3,510,421	—	—	\$(4,889,155)
Services and Supplies	\$1,540,604	\$1,989,628	\$1,005,701	—	—	\$(1,989,628)
Other Charges	\$(16,798)	\$210,027	—	—	—	\$(210,027)
Capital Assets	\$16,979	—	\$164,636	—	—	—
Subtotal	\$4,962,667	\$7,088,810	\$4,680,758	—	—	\$(7,088,810)

Source of Funds

Revenues	Prior Year 2021-2022	Adopted Budget 2022-2023	CY Estimate 2022-2023	Requested Budget 2023-2024	Recommended Budget 2023-2024	Recommended Change from Adopted
Intergovernmental Revenues	\$84,714	\$88,029	\$88,029	—	—	\$(88,029)
Charges for Services	\$5,508,733	\$6,848,465	\$5,158,341	—	—	\$(6,848,465)
Other Financing Sources	\$38,447	\$19,793	\$19,793	—	—	\$(19,793)
Subtotal	\$5,631,894	\$6,956,287	\$5,266,163	—	—	\$(6,956,287)
General Fund Contributions	\$(669,227)	\$132,523	\$(585,405)	—	—	\$(132,523)
Total Source of Funds	\$4,962,667	\$7,088,810	\$4,680,758	—	—	\$(7,088,810)

Unit Description

Effective Fiscal Year 2023-24, this Unit is consolidated in Unit 8592.

Laurel Pediatrics

(Budget Unit 8101—Fund 001—Appropriation Unit HEA007)

Use of Funds

Intentionally Left Blank

Source of Funds

Intentionally Left Blank

Use of Funds

Expenditures	Prior Year 2021-2022	Adopted Budget 2022-2023	CY Estimate 2022-2023	Requested Budget 2023-2024	Recommended Budget 2023-2024	Recommended Change from Adopted
Salaries and Employee Benefits	\$5,258,822	\$6,946,269	\$5,831,560	—	—	\$(6,946,269)
Services and Supplies	\$1,046,434	\$1,021,346	\$709,090	—	—	\$(1,021,346)
Other Charges	\$(57,112)	\$523,915	—	—	—	\$(523,915)
Capital Assets	—	—	\$352,172	—	—	—
Subtotal	\$6,248,143	\$8,491,530	\$6,892,822	—	—	\$(8,491,530)

Source of Funds

Revenues	Prior Year 2021-2022	Adopted Budget 2022-2023	CY Estimate 2022-2023	Requested Budget 2023-2024	Recommended Budget 2023-2024	Recommended Change from Adopted
Intergovernmental Revenues	\$216,461	\$238,728	\$238,728	—	—	\$(238,728)
Charges for Services	\$5,564,679	\$8,898,630	\$6,737,434	—	—	\$(8,898,630)
Other Financing Sources	\$38,516	\$19,793	\$19,793	—	—	\$(19,793)
Subtotal	\$5,819,657	\$9,157,151	\$6,995,955	—	—	\$(9,157,151)
General Fund Contributions	\$428,486	\$(665,621)	\$(103,133)	—	—	\$665,621
Total Source of Funds	\$6,248,143	\$8,491,530	\$6,892,822	—	—	\$(8,491,530)

Unit Description

Effective Fiscal Year 2023-24, this Unit is consolidated in Unit 8592.

Marina Health Center

(Budget Unit 8103—Fund 001—Appropriation Unit HEA007)

Use of Funds	Source of Funds
Intentionally Left Blank	Intentionally Left Blank

Use of Funds

Expenditures	Prior Year 2021-2022	Adopted Budget 2022-2023	CY Estimate 2022-2023	Requested Budget 2023-2024	Recommended Budget 2023-2024	Recommended Change from Adopted
Salaries and Employee Benefits	\$1,141,758	\$1,508,378	\$1,476,949	—	—	\$(1,508,378)
Services and Supplies	\$364,541	\$374,445	\$376,969	—	—	\$(374,445)
Other Charges	\$380,136	\$461,796	—	—	—	\$(461,796)
Capital Assets	—	—	\$67,653	—	—	—
Subtotal	\$1,886,435	\$2,344,619	\$1,921,571	—	—	\$(2,344,619)

Source of Funds

Revenues	Prior Year 2021-2022	Adopted Budget 2022-2023	CY Estimate 2022-2023	Requested Budget 2023-2024	Recommended Budget 2023-2024	Recommended Change from Adopted
Intergovernmental Revenues	\$110,139	\$148,686	\$148,686	—	—	\$(148,686)
Charges for Services	\$1,703,856	\$2,204,866	\$2,179,084	—	—	\$(2,204,866)
Miscellaneous Revenues	\$15,000	\$15,000	\$15,000	—	—	\$(15,000)
Other Financing Sources	\$349	—	—	—	—	—
Subtotal	\$1,829,343	\$2,368,552	\$2,342,770	—	—	\$(2,368,552)
General Fund Contributions	\$57,092	\$(23,933)	\$(421,199)	—	—	\$23,933
Total Source of Funds	\$1,886,435	\$2,344,619	\$1,921,571	—	—	\$(2,344,619)

Unit Description

Effective Fiscal Year 2023-24, this Unit is consolidated in Unit 8592.

Seaside Family Health Center

(Budget Unit 8105—Fund 001—Appropriation Unit HEA007)

Use of Funds

Source of Funds

Intentionally Left Blank

Intentionally Left Blank

Use of Funds

Expenditures	Prior Year 2021-2022	Adopted Budget 2022-2023	CY Estimate 2022-2023	Requested Budget 2023-2024	Recommended Budget 2023-2024	Recommended Change from Adopted
Salaries and Employee Benefits	\$6,947,828	\$9,165,108	\$7,025,849	—	—	\$(9,165,108)
Services and Supplies	\$1,649,990	\$1,586,367	\$2,401,346	—	—	\$(1,586,367)
Other Charges	\$792,876	\$1,491,349	—	—	—	\$(1,491,349)
Capital Assets	—	—	\$15,939	—	—	—
Subtotal	\$9,390,693	\$12,242,824	\$9,443,134	—	—	\$(12,242,824)

Source of Funds

Revenues	Prior Year 2021-2022	Adopted Budget 2022-2023	CY Estimate 2022-2023	Requested Budget 2023-2024	Recommended Budget 2023-2024	Recommended Change from Adopted
Revenue from Use of Money & Property	\$15,186	\$15,490	\$15,490	—	—	\$(15,490)
Intergovernmental Revenues	\$429,613	\$496,406	\$496,406	—	—	\$(496,406)
Charges for Services	\$9,318,358	\$10,894,950	\$9,643,367	—	—	\$(10,894,950)
Miscellaneous Revenues	\$60,000	\$60,000	\$60,000	—	—	\$(60,000)
Other Financing Sources	\$698	—	—	—	—	—
Subtotal	\$9,823,855	\$11,466,846	\$10,215,263	—	—	\$(11,466,846)
General Fund Contributions	\$(433,162)	\$775,978	\$(772,129)	—	—	\$(775,978)
Total Source of Funds	\$9,390,693	\$12,242,824	\$9,443,134	—	—	\$(12,242,824)

Unit Description

Effective Fiscal Year 2023-24, this Unit is consolidated in Unit 8592.

Ambulance Service

(Budget Unit 8108—Fund 092—Appropriation Unit HEA010)

Use of Funds

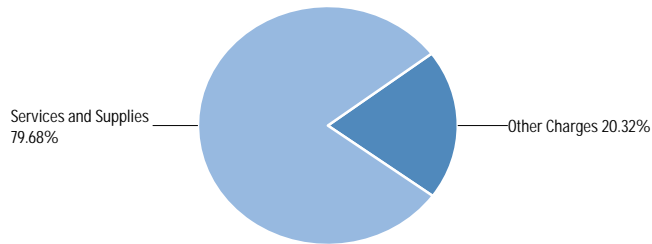

Source of Funds

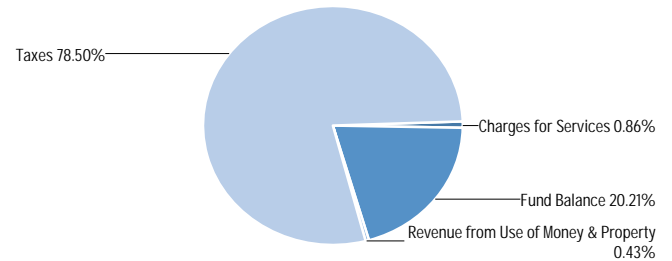

Use of Funds

Expenditures	Prior Year 2021-2022	Adopted Budget 2022-2023	CY Estimate 2022-2023	Requested Budget 2023-2024	Recommended Budget 2023-2024	Recommended Change from Adopted
Services and Supplies	\$1,284,527	\$1,723,103	\$1,648,049	\$1,862,495	\$1,862,495	\$139,392
Other Charges	\$477,215	\$475,000	\$471,023	\$475,000	\$475,000	—
Subtotal	\$1,761,742	\$2,198,103	\$2,119,072	\$2,337,495	\$2,337,495	\$139,392

Source of Funds

Revenues	Prior Year 2021-2022	Adopted Budget 2022-2023	CY Estimate 2022-2023	Requested Budget 2023-2024	Recommended Budget 2023-2024	Recommended Change from Adopted
Taxes	\$1,839,057	\$1,800,000	\$1,835,000	\$1,835,000	\$1,835,000	\$35,000
Revenue from Use of Money & Property	\$18,055	\$30,000	\$18,000	\$10,000	\$10,000	\$(20,000)
Charges for Services	\$22,973	\$20,000	\$20,000	\$20,000	\$20,000	—
Subtotal	\$1,880,085	\$1,850,000	\$1,873,000	\$1,865,000	\$1,865,000	\$15,000
Fund Balance	\$(118,344)	\$348,103	\$246,072	\$472,495	\$472,495	\$124,392
Total Source of Funds	\$1,761,742	\$2,198,103	\$2,119,072	\$2,337,495	\$2,337,495	\$139,392

Unit Description

The Monterey County Emergency Medical Services (EMS) system provides paramedic, ambulance and related services.

Originally County Service Area 74 (CSA-74) was formed to provide funding for paramedic, ambulance, and related services. On March 7,

2000, Monterey County voters approved Measure A, replacing the former CSA 74 benefit assessment with an equivalent special tax, in compliance with Proposition 218. The special tax is collected and administered by the Emergency Medical Services (EMS) Agency.

EMS Operating

(Budget Unit 8109—Fund 001—Appropriation Unit HEA006)

Use of Funds

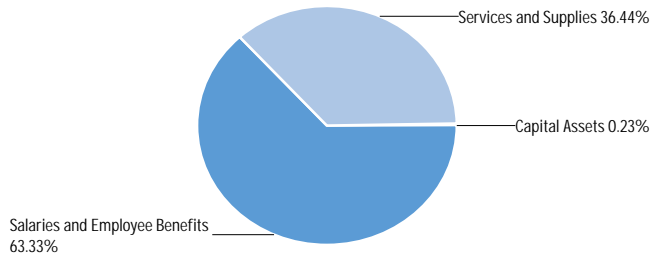

Source of Funds

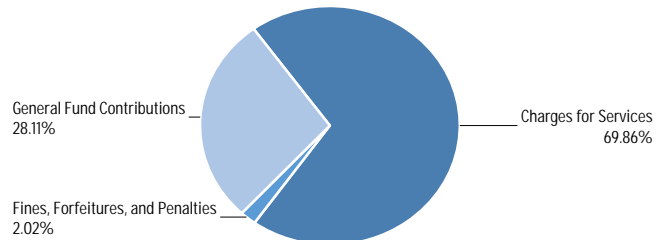

Use of Funds

Expenditures	Prior Year 2021-2022	Adopted Budget 2022-2023	CY Estimate 2022-2023	Requested Budget 2023-2024	Recommended Budget 2023-2024	Recommended Change from Adopted
Salaries and Employee Benefits	\$944,956	\$1,323,803	\$1,221,290	\$1,401,952	\$1,401,952	\$78,149
Services and Supplies	\$710,051	\$794,494	\$790,960	\$806,681	\$806,681	\$12,187
Other Charges	\$(1,221,746)	\$(1,798,603)	\$(1,698,514)	\$(1,966,502)	\$(1,966,502)	\$(167,899)
Capital Assets	\$3,841	—	\$154,958	\$5,000	\$5,000	\$5,000
Subtotal	\$437,101	\$319,694	\$468,694	\$247,131	\$247,131	\$(72,563)

Source of Funds

Revenues	Prior Year 2021-2022	Adopted Budget 2022-2023	CY Estimate 2022-2023	Requested Budget 2023-2024	Recommended Budget 2023-2024	Recommended Change from Adopted
Fines, Forfeitures, and Penalties	—	\$5,000	\$4,000	\$5,000	\$5,000	—
Intergovernmental Revenues	\$20,000	—	—	—	—	—
Charges for Services	\$172,658	\$172,658	\$172,658	\$172,658	\$172,658	—
Subtotal	\$192,658	\$177,658	\$176,658	\$177,658	\$177,658	—
General Fund Contributions	\$244,443	\$142,036	\$292,036	\$69,473	\$69,473	\$(72,563)
Total Source of Funds	\$437,101	\$319,694	\$468,694	\$247,131	\$247,131	\$(72,563)

Unit Description

The Emergency Medical Services (EMS) Agency is designated by the Monterey County Board of Supervisors, pursuant to California Health and Safety Code, Section 1797.200, as the Local EMS Agency. The local EMS Agency is responsible to plan, implement, and evaluate the Emergency Medical Services System, consisting of organized patterns of readiness and response services based on public and private agreements and operational procedures. The Local EMS Agency is also responsible to implement advanced life support systems, and to establish policies and procedures approved by the Medical Director of the Local EMS Agency to assure medical control of the EMS system. In addition, EMS Agency staff administer funds received through the CSA-74 Special Tax (Fund 092) and the Uncompensated Care Fund (Fund 016).

Recommended FY 2023-24 Positions

Classification Code	Classification Label	FTE
12E04	BUREAU CHIEF	1.00
14C31	MANAGEMENT ANALYST III	1.00
14C70	ADMINISTRATIVE SERVICES ASSISTANT	1.00
20B10	ACCOUNTANT I	1.00
50B12	EMERGENCY MEDICAL SERVICES ANALYST	4.00
50K18	HEALTH PROGRAM COORDINATOR	1.00
Total		9.00

Uncompensated Care

(Budget Unit 8111—Fund 016—Appropriation Unit HEA009)

Use of Funds

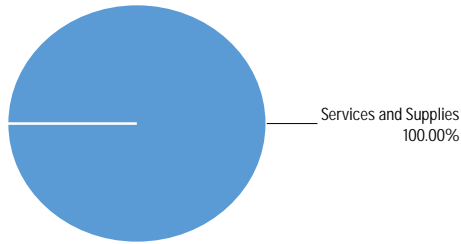

Source of Funds

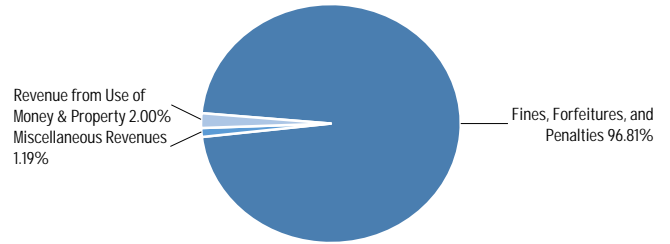

Use of Funds

Expenditures	Prior Year 2021-2022	Adopted Budget 2022-2023	CY Estimate 2022-2023	Requested Budget 2023-2024	Recommended Budget 2023-2024	Recommended Change from Adopted
Services and Supplies	\$403,045	\$603,000	\$621,889	\$708,900	\$708,900	\$105,900
Subtotal	\$403,045	\$603,000	\$621,889	\$708,900	\$708,900	\$105,900

Source of Funds

Revenues	Prior Year 2021-2022	Adopted Budget 2022-2023	CY Estimate 2022-2023	Requested Budget 2023-2024	Recommended Budget 2023-2024	Recommended Change from Adopted
Fines, Forfeitures, and Penalties	\$656,934	\$910,000	\$825,000	\$725,000	\$725,000	\$(185,000)
Revenue from Use of Money & Property	\$10,079	\$15,000	\$10,000	\$15,000	\$15,000	—
Miscellaneous Revenues	\$8,853	\$10,000	\$8,900	\$8,900	\$8,900	\$(1,100)
Subtotal	\$675,866	\$935,000	\$843,900	\$748,900	\$748,900	\$(186,100)
Fund Balance	\$(272,821)	\$(332,000)	\$(222,011)	\$(40,000)	\$(40,000)	\$292,000
Total Source of Funds	\$403,045	\$603,000	\$621,889	\$708,900	\$708,900	\$105,900

Unit Description

Uncompensated Care Fund 016 was established in 1989 to provide for collection and distribution of fine proceeds authorized by the California State Legislature through Senate Bill (SB) 612 and SB 1773. These laws allow counties to levy an assessment of \$4.00 per \$10.00 of fines for specified traffic violations. Pursuant to State Law, up to 10% of the proceeds are available to fund the program's administration. The remaining 90% is distributed to physicians and

hospitals for patients who do not make payments for EMS and for other emergency medical services as follows: 58% to reimburse physicians for a portion of unreimbursed indigent services/bad debt costs; 25% to reimburse hospitals which provide a disproportionate share of unreimbursed emergency medical care; and 17% to support the Health Department's Emergency Medical Services (EMS) Agency activities.

Consumer Health Protection Services

(Budget Unit 8112—Fund 001—Appropriation Unit HEA005)

Use of Funds

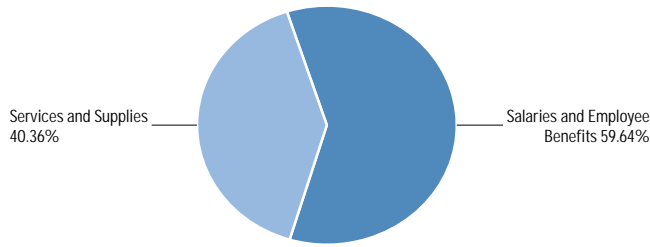

Source of Funds

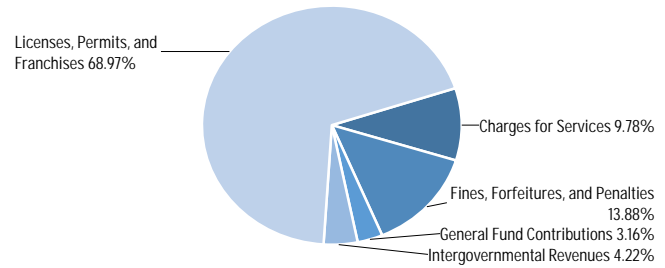

Use of Funds

Expenditures	Prior Year 2021-2022	Adopted Budget 2022-2023	CY Estimate 2022-2023	Requested Budget 2023-2024	Recommended Budget 2023-2024	Recommended Change from Adopted
Salaries and Employee Benefits	\$2,313,587	\$2,923,711	\$2,838,984	\$2,875,537	\$2,875,537	\$(48,174)
Services and Supplies	\$1,266,951	\$1,844,747	\$1,501,285	\$1,946,075	\$1,946,075	\$101,328
Other Charges	\$(120,348)	—	—	—	—	—
Subtotal	\$3,460,190	\$4,768,458	\$4,340,269	\$4,821,612	\$4,821,612	\$53,154

Source of Funds

Revenues	Prior Year 2021-2022	Adopted Budget 2022-2023	CY Estimate 2022-2023	Requested Budget 2023-2024	Recommended Budget 2023-2024	Recommended Change from Adopted
Licenses, Permits, and Franchises	\$1,731,890	\$3,029,664	\$2,850,000	\$3,325,370	\$3,325,370	\$295,706
Fines, Forfeitures, and Penalties	\$669,051	\$669,051	\$250,000	\$669,051	\$669,051	—
Intergovernmental Revenues	\$82,966	\$228,497	\$164,174	\$203,265	\$203,265	\$(25,232)
Charges for Services	\$491,001	\$463,424	\$415,000	\$471,562	\$471,562	\$8,138
Miscellaneous Revenues	—	—	—	\$1	\$1	\$1
Subtotal	\$2,974,907	\$4,390,636	\$3,679,174	\$4,669,249	\$4,669,249	\$278,613
General Fund Contributions	\$485,283	\$377,822	\$661,095	\$152,363	\$152,363	\$(225,459)
Total Source of Funds	\$3,460,190	\$4,768,458	\$4,340,269	\$4,821,612	\$4,821,612	\$53,154

Unit Description

Consumer Health Protection Services (CHPS) is responsible for the regulatory oversight of all retail food activities in all areas of the county including but not limited to restaurants, markets, delis, cottage food operations, mobile food trucks, and temporary food booths at special events. In addition, CHPS conducts food inspections at institutional operations such as cafeterias in schools, hospitals, skilled nursing, and detention facilities. Outside of retail food activities, CHPS is also responsible for the regulatory oversight of employee housing, recreational and beach water quality monitoring, public swimming pools and spas, vector control, agricultural field toilets, and tobacco retail licensing. Lastly, CHPS oversees other health protection activities such as the Childhood Lead Poisoning Prevention Program, complaint response involving vectors, substandard housing, mold and sanitation, and the Summer School Lunch inspection program.

Recommended FY 2023-24 Positions

Classification Code	Classification Label	FTE
30J21	ENVIRONMENTAL HEALTH SPECIALIST II	10.00
30J31	ENVIRONMENTAL HEALTH SPECIALIST III	5.00
30J84	ENVIRONMENTAL HEALTH SPECIALIST IV	2.00
80E21	OFFICE ASSISTANT II	2.00
80E80	PRINCIPAL OFFICE ASSISTANT	3.00
Total		22.00

Recycling and Resource Recovery Services

(Budget Unit 8113—Fund 001—Appropriation Unit HEA005)

Use of Funds

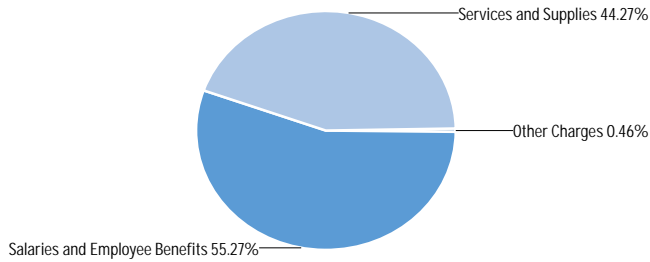

Source of Funds

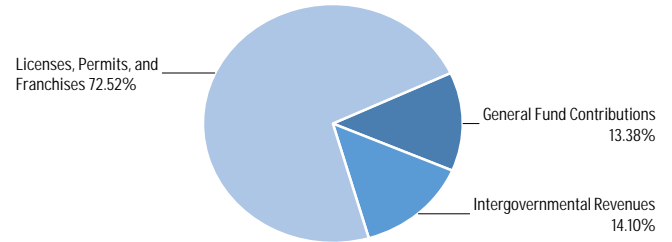

Use of Funds

Expenditures	Prior Year 2021-2022	Adopted Budget 2022-2023	CY Estimate 2022-2023	Requested Budget 2023-2024	Recommended Budget 2023-2024	Recommended Change from Adopted
Salaries and Employee Benefits	\$503,217	\$573,356	\$525,239	\$599,380	\$599,380	\$26,024
Services and Supplies	\$465,289	\$428,062	\$460,980	\$480,175	\$480,175	\$52,113
Other Charges	\$5,000	\$5,000	\$5,000	\$5,000	\$5,000	—
Capital Assets	—	—	\$32,577	—	—	—
Subtotal	\$973,507	\$1,006,418	\$1,023,796	\$1,084,555	\$1,084,555	\$78,137

Source of Funds

Revenues	Prior Year 2021-2022	Adopted Budget 2022-2023	CY Estimate 2022-2023	Requested Budget 2023-2024	Recommended Budget 2023-2024	Recommended Change from Adopted
Licenses, Permits, and Franchises	\$766,292	\$747,079	\$786,507	\$786,508	\$786,508	\$39,429
Intergovernmental Revenues	\$175,704	\$118,000	\$84,211	\$152,887	\$152,887	\$34,887
Charges for Services	—	\$3	\$3	\$3	\$3	—
Miscellaneous Revenues	—	\$5	\$5	\$5	\$5	—
Subtotal	\$941,996	\$865,087	\$870,726	\$939,403	\$939,403	\$74,316
General Fund Contributions	\$31,511	\$141,331	\$153,070	\$145,152	\$145,152	\$3,821
Total Source of Funds	\$973,507	\$1,006,418	\$1,023,796	\$1,084,555	\$1,084,555	\$78,137

Unit Description

Recycling and Resource Recovery Services (RRRS) is responsible for oversight of the Residential, Business, Multi-family, and Special Events Waste Diversion programs, and the Recycling Public Education program. RRRS promotes countywide cleanup events, which supports the Solid Waste Management Service's (SWMS) Illegal Dumping and Litter Abatement program to combat illegal dumping. RRRS also serves as administrator for the Unified Franchise Agreement for solid waste collection as well as administrator for several grants that fund program activities such as waste oil collection and waste tire inspections.

Recommended FY 2023-24 Positions

Classification Code	Classification Label	FTE
20B10	ACCOUNTANT I	1.00
30J21	ENVIRONMENTAL HEALTH SPECIALIST II	1.00
30J81	RECYCLING/RESOURCE RECOVERY SPECIALIST	2.00
80E01	OFFICE ASSISTANT I	1.00
Total		5.00

Land Use

(Budget Unit 8115—Fund 001—Appropriation Unit HEA005)

Use of Funds

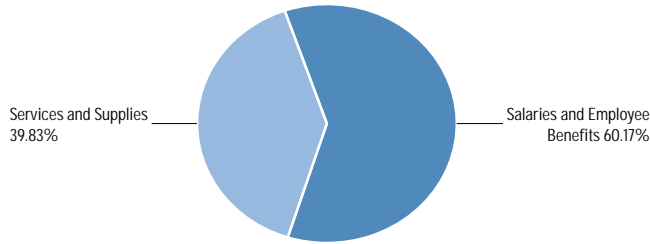

Source of Funds

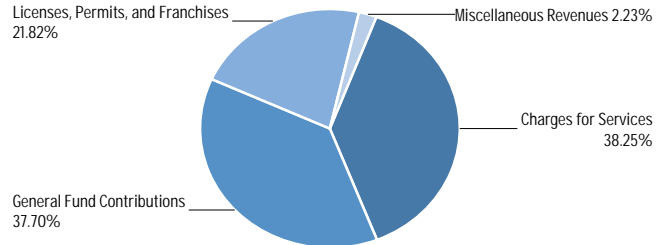

Use of Funds

Expenditures	Prior Year 2021-2022	Adopted Budget 2022-2023	CY Estimate 2022-2023	Requested Budget 2023-2024	Recommended Budget 2023-2024	Recommended Change from Adopted
Salaries and Employee Benefits	\$487,588	\$775,778	\$639,257	\$648,020	\$648,020	\$(127,758)
Services and Supplies	\$374,774	\$403,537	\$443,249	\$429,018	\$429,018	\$25,481
Subtotal	\$862,363	\$1,179,315	\$1,082,506	\$1,077,038	\$1,077,038	\$(102,277)

Source of Funds

Revenues	Prior Year 2021-2022	Adopted Budget 2022-2023	CY Estimate 2022-2023	Requested Budget 2023-2024	Recommended Budget 2023-2024	Recommended Change from Adopted
Licenses, Permits, and Franchises	\$208,917	\$126,734	\$124,380	\$235,007	\$235,007	\$108,273
Intergovernmental Revenues	—	\$1	\$1	\$1	\$1	—
Charges for Services	\$430,269	\$355,002	\$325,002	\$412,002	\$412,002	\$57,000
Miscellaneous Revenues	\$13,607	\$24,001	\$24,001	\$24,001	\$24,001	—
Other Financing Sources	—	\$1	\$1	\$1	\$1	—
Subtotal	\$652,793	\$505,739	\$473,385	\$671,012	\$671,012	\$165,273
General Fund Contributions	\$209,570	\$673,576	\$609,121	\$406,026	\$406,026	\$(267,550)
Total Source of Funds	\$862,363	\$1,179,315	\$1,082,506	\$1,077,038	\$1,077,038	\$(102,277)

Unit Description

Land Use serves as the liaison between the Environmental Health Bureau (EHB) and the Housing and Community Development (HCD) and is responsible for review of development project applications, including but not limited to lot line adjustments, creation of housing subdivisions, establishment of cannabis business operations, and evaluation of construction permits to ensure conformance with regulations where EHB is the regulatory agency. Additionally, this program reviews, inspects, and approves Onsite Wastewater Treatment Systems (OWTS) and monitors water quality of discharges from sewage treatment and wastewater reclamation facilities.

Recommended FY 2023-24 Positions

Classification Code	Classification Label	FTE
30J21	ENVIRONMENTAL HEALTH SPECIALIST II	1.00
30J31	ENVIRONMENTAL HEALTH SPECIALIST III	3.00
30J84	ENVIRONMENTAL HEALTH SPECIALIST IV	1.00
Total		5.00

Hazardous Materials & Solid Waste Management

(Budget Unit 8116—Fund 001—Appropriation Unit HEA005)

Use of Funds

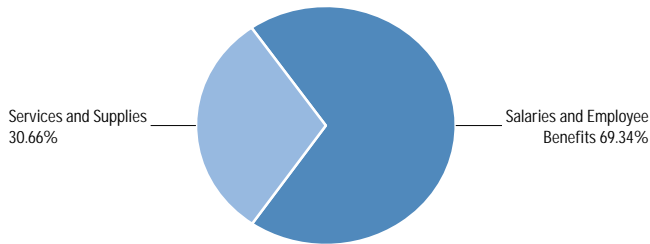

Source of Funds

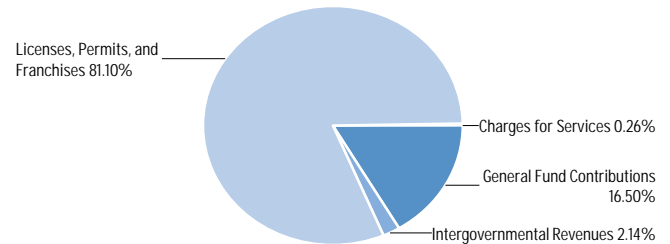

Use of Funds

Expenditures	Prior Year 2021-2022	Adopted Budget 2022-2023	CY Estimate 2022-2023	Requested Budget 2023-2024	Recommended Budget 2023-2024	Recommended Change from Adopted
Salaries and Employee Benefits	\$2,060,217	\$2,704,333	\$2,147,767	\$2,665,491	\$2,665,491	\$(38,842)
Services and Supplies	\$1,182,162	\$1,129,588	\$1,201,320	\$1,306,788	\$1,178,788	\$49,200
Other Charges	\$(19,098)	—	—	—	—	—
Subtotal	\$3,223,281	\$3,833,921	\$3,349,087	\$3,972,279	\$3,844,279	\$10,358

Source of Funds

Revenues	Prior Year 2021-2022	Adopted Budget 2022-2023	CY Estimate 2022-2023	Requested Budget 2023-2024	Recommended Budget 2023-2024	Recommended Change from Adopted
Licenses, Permits, and Franchises	\$2,742,443	\$3,068,833	\$2,723,462	\$3,117,862	\$3,117,862	\$49,029
Fines, Forfeitures, and Penalties	\$133,430	\$1	\$15,000	\$1	\$1	—
Intergovernmental Revenues	\$101,262	\$109,000	\$61,230	\$82,195	\$82,195	\$(26,805)
Charges for Services	\$76,786	\$10,002	\$23,001	\$10,002	\$10,002	—
Miscellaneous Revenues	—	\$2	\$2	\$2	\$2	—
Subtotal	\$3,053,921	\$3,187,838	\$2,822,695	\$3,210,062	\$3,210,062	\$22,224
General Fund Contributions	\$169,359	\$646,083	\$526,392	\$762,217	\$634,217	\$(11,866)
Total Source of Funds	\$3,223,281	\$3,833,921	\$3,349,087	\$3,972,279	\$3,844,279	\$10,358

Unit Description

Hazardous Materials Management Services (HMMS) is designated as the local Certified Unified Program Agency (CUPA) in Monterey County and is responsible for inspecting facilities in the County to verify proper storage, handling and disposal of hazardous materials and hazardous wastes. HMMS is responsible for permitting and conducting inspections of underground storage tanks and aboveground petroleum storage tanks, business response plans, hazardous waste, California Accidental Release Prevention Program and contaminated site mitigation. Additionally, HMMS provides emergency response 24 hours each day, seven days per week, to oversee hazardous material spill site cleanup activities and to operate the pesticide illness reporting program. Solid Waste Management Services (SWMS) is designated as CalRecycle's Local Enforcement Agency (LEA) and the Tire Enforcement Agency (TEA) for

Monterey County. LEA/TEA is responsible for permitting and inspecting solid waste handling facilities such as landfills, transfer stations, compost facilities, waste tire generators, haulers, and end use facilities. SWMS also implements inspection enforcement programs for the body art, medical waste, solid waste vehicle, liquid waste vehicle, and vegetable cull feeder programs. SWMS staff is responsible for the local Illegal Dumping and Litter Abatement Program, responding to illegal dumping complaints to ensure the timely clean up and proper disposal of abandoned waste. Staff of SWMS also administers State-funded grants that support program activities. Cannabis Management Services (CMS) is responsible for permitting and inspecting cannabis businesses including grow operations, manufacturers, retail distribution and laboratory testing facilities. CMS inspections include but are not limited to hazardous materials, water quality, food ingredient handling and storage, and waste management. CMS is also involved in responding to issues related to illegal cannabis activities such as illegal grow sites and

cannabis products from unapproved sources. CMS operates in all parts of the county, but in particular is a major component of the County Administrative Office’s Intergovernmental and Legislative Affairs (CAO-IGLA) Cannabis Program that is responsible for the regulatory oversight of all cannabis activities within the unincorporated areas of the county. CMS also participates in the Health Department’s Cannabis Ad Hoc Committee that seeks to promote public health messaging specifically the negative health effects caused by the abuse of cannabis by youth, adults and expectant mothers.

Recommended FY 2023-24 Positions

Classification Code	Classification Label	FTE
30J21	ENVIRONMENTAL HEALTH SPECIALIST II	7.00
30J31	ENVIRONMENTAL HEALTH SPECIALIST III	6.00
30J84	ENVIRONMENTAL HEALTH SPECIALIST IV	3.00
80E22	OFFICE ASSISTANT III	3.00
Total		19.00

Environmental Health Fiscal and Administration

(Budget Unit 8117—Fund 001—Appropriation Unit HEA005)

Use of Funds

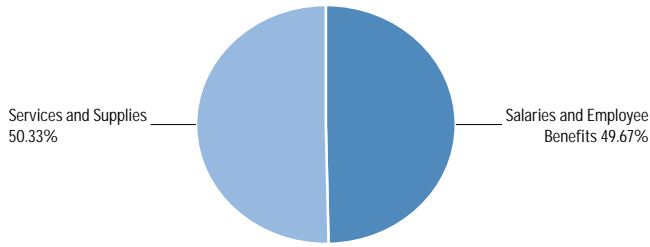

Source of Funds

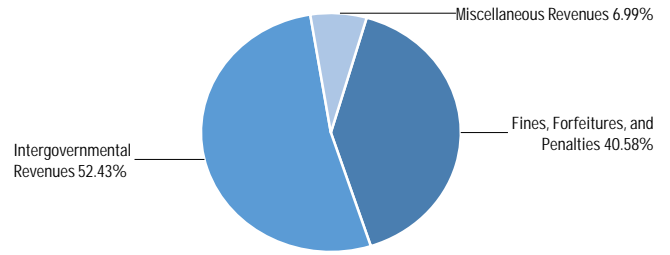

Health

Use of Funds

Expenditures	Prior Year 2021-2022	Adopted Budget 2022-2023	CY Estimate 2022-2023	Requested Budget 2023-2024	Recommended Budget 2023-2024	Recommended Change from Adopted
Salaries and Employee Benefits	\$942,163	\$1,271,528	\$1,126,991	\$1,405,892	\$1,405,892	\$134,364
Services and Supplies	\$1,350,362	\$925,399	\$1,006,559	\$1,424,514	\$1,424,514	\$499,115
Other Charges	\$(2,064,208)	\$(2,145,801)	\$(2,075,156)	\$(3,094,462)	\$(3,094,462)	\$(948,661)
Subtotal	\$228,317	\$51,126	\$58,394	\$(264,056)	\$(264,056)	\$(315,182)

Source of Funds

Revenues	Prior Year 2021-2022	Adopted Budget 2022-2023	CY Estimate 2022-2023	Requested Budget 2023-2024	Recommended Budget 2023-2024	Recommended Change from Adopted
Licenses, Permits, and Franchises	\$95	—	—	—	—	—
Fines, Forfeitures, and Penalties	\$142,787	\$73,245	\$55,000	\$58,048	\$58,048	\$(15,197)
Intergovernmental Revenues	—	—	—	\$75,000	\$75,000	\$75,000
Charges for Services	\$4,049	—	\$4,500	—	—	—
Miscellaneous Revenues	\$31,440	—	\$22,000	\$10,000	\$10,000	\$10,000
Subtotal	\$178,371	\$73,245	\$81,500	\$143,048	\$143,048	\$69,803
General Fund Contributions	\$49,947	\$(22,119)	\$(23,106)	\$(407,104)	\$(407,104)	\$(384,985)
Total Source of Funds	\$228,317	\$51,126	\$58,394	\$(264,056)	\$(264,056)	\$(315,182)

Unit Description

Environmental Health Fiscal and Administration provides financial and administrative oversight for the EHB major regulatory oversight programs: Consumer Health Protection, Recycling and Resource Recovery, Environmental Health Review, Hazardous Materials Management, Solid Waste Management, Cannabis Management and Drinking Water Protection Services. Fiscal and administrative services include strategic planning and goal setting, budget preparation and oversight, coordination and execution of billing and collection activities, procurement and accounts payable management, contract and grant management, information management systems support, preparation of board reports and legislative reviews, departmental human resources liaison, fleet vehicle management, office logistics and supplies, workman’s compensation coordination, bureau wide monitoring and tracking of training activities, and implementation of workplace safety standards.

Recommended FY 2023-24 Positions

Classification Code	Classification Label	FTE
12E04	BUREAU CHIEF	1.00
14C30	MANAGEMENT ANALYST II	1.00
14C31	MANAGEMENT ANALYST III	1.00
14G02	MANAGEMENT ANALYST I	1.00
14K44	ASSISTANT BUREAU CHIEF	1.00
14K61	ENVIRONMENTAL HEALTH PROGRAM MANAGER	1.00
20B11	ACCOUNTANT II	1.00
80E82	SUPERVISING OFFICE ASSISTANT II	1.00
80J22	SENIOR ACCOUNT CLERK	1.00
Total		9.00

Public Guardian/Administrator/Conservator

(Budget Unit 8118—Fund 001—Appropriation Unit HEA008)

Use of Funds

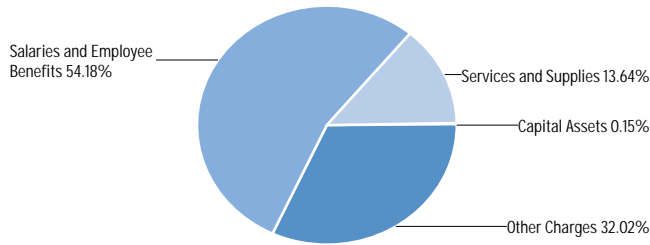

Source of Funds

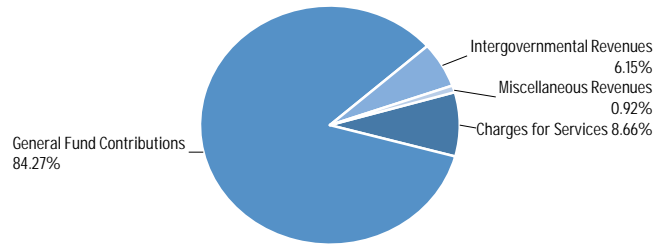

Use of Funds

Expenditures	Prior Year 2021-2022	Adopted Budget 2022-2023	CY Estimate 2022-2023	Requested Budget 2023-2024	Recommended Budget 2023-2024	Recommended Change from Adopted
Salaries and Employee Benefits	\$1,306,557	\$1,727,134	\$1,668,690	\$1,770,510	\$1,770,510	\$43,376
Services and Supplies	\$359,868	\$351,037	\$327,605	\$445,777	\$445,777	\$94,740
Other Charges	\$770,120	\$1,022,040	\$1,022,040	\$1,046,302	\$1,046,302	\$24,262
Capital Assets	\$40,740	—	\$47,629	\$5,000	\$5,000	\$5,000
Subtotal	\$2,477,285	\$3,100,211	\$3,065,964	\$3,267,589	\$3,267,589	\$167,378

Source of Funds

Revenues	Prior Year 2021-2022	Adopted Budget 2022-2023	CY Estimate 2022-2023	Requested Budget 2023-2024	Recommended Budget 2023-2024	Recommended Change from Adopted
Intergovernmental Revenues	\$287,956	\$178,328	\$202,129	\$200,947	\$200,947	\$22,619
Charges for Services	\$325,983	\$263,062	\$212,976	\$282,882	\$282,882	\$19,820
Miscellaneous Revenues	\$37,636	\$30,000	\$19,200	\$30,000	\$30,000	—
Subtotal	\$651,575	\$471,390	\$434,305	\$513,829	\$513,829	\$42,439
General Fund Contributions	\$1,825,710	\$2,628,821	\$2,631,659	\$2,753,760	\$2,753,760	\$124,939
Total Source of Funds	\$2,477,285	\$3,100,211	\$3,065,964	\$3,267,589	\$3,267,589	\$167,378

Unit Description

The Public Administrator is mandated by law to take charge of property if no personal representative has been appointed, the public administrator of a county shall take prompt possession or control of property of a decedent in the county that is deemed by the public administrator to be subject to loss, injury, waste, or misappropriation Probate Code - PROB 7601.

The Public Conservator is the court appointed Lanterman Petris Short Conservator of any individual found to be gravely disabled as a condition in which a person as a result of a mental disorder is unable to provide for his or her basic personal needs for food, clothing or shelter. Welfare & Institutions Code 5008(h)(1)(A).

The Public Guardian serves as Public Representative Payee pursuant to Board Resolution 82-43 for Monterey County residents deemed incapable of managing their own public entitlement benefits. Referrals to the Bureau are investigated to determine whether the assistance of the Public Guardian/Administrator/Conservator is necessary. If assistance is needed, the Public Representative Payee

manages and/or applies for any public entitlement benefits on behalf of disabled Monterey County residents.

Recommended FY 2023-24 Positions

Classification Code	Classification Label	FTE
14N06	OPERATIONS MANAGER	1.00
20B12	ACCOUNTANT III	1.00
34H24	DEPUTY PUBLIC ADMINISTRATOR/ GUARDIAN/CONSERVATOR I	2.50
34H34	DEPUTY PUBLIC ADMINISTRATOR/ GUARDIAN/CONSERVATOR II	4.00
80E21	OFFICE ASSISTANT II	2.00
80E22	OFFICE ASSISTANT III	1.00
80E80	PRINCIPAL OFFICE ASSISTANT	1.00
80J22	SENIOR ACCOUNT CLERK	1.00
80J30	ACCOUNTING TECHNICIAN	1.00
Total		14.50

Children's Medical Services

(Budget Unit 8121—Fund 001—Appropriation Unit HEA004)

Use of Funds

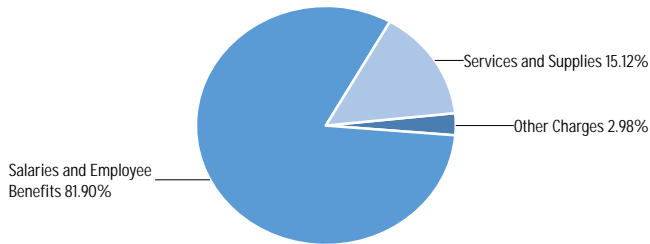

Source of Funds

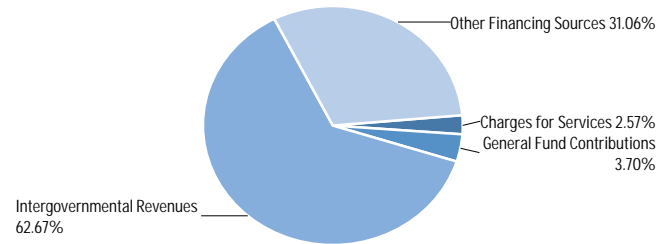

Use of Funds

Expenditures	Prior Year 2021-2022	Adopted Budget 2022-2023	CY Estimate 2022-2023	Requested Budget 2023-2024	Recommended Budget 2023-2024	Recommended Change from Adopted
Salaries and Employee Benefits	\$3,471,840	\$3,942,637	\$3,599,549	\$4,296,205	\$4,296,205	\$353,568
Services and Supplies	\$709,720	\$800,355	\$901,715	\$792,953	\$792,953	\$(7,402)
Other Charges	\$478,244	\$433,421	\$456,199	\$156,570	\$156,570	\$(276,851)
Subtotal	\$4,659,804	\$5,176,413	\$4,957,463	\$5,245,728	\$5,245,728	\$69,315

Source of Funds

Revenues	Prior Year 2021-2022	Adopted Budget 2022-2023	CY Estimate 2022-2023	Requested Budget 2023-2024	Recommended Budget 2023-2024	Recommended Change from Adopted
Intergovernmental Revenues	\$6,043,038	\$3,414,243	\$1,526,694	\$3,287,320	\$3,287,320	\$(126,923)
Charges for Services	\$142,113	\$136,570	\$129,737	\$135,000	\$135,000	\$(1,570)
Other Financing Sources	\$1,218,318	\$1,625,600	\$3,282,679	\$1,629,531	\$1,629,531	\$3,931
Subtotal	\$7,403,469	\$5,176,413	\$4,939,110	\$5,051,851	\$5,051,851	\$(124,562)
General Fund Contributions	\$(2,743,665)	—	\$18,353	\$193,877	\$193,877	\$193,877
Total Source of Funds	\$4,659,804	\$5,176,413	\$4,957,463	\$5,245,728	\$5,245,728	\$69,315

Unit Description

Children's Medical Services provides services to improve health status, mitigate morbidity and reduce health disparities by promoting access to quality preventive and specialty medical care for Monterey County children. Programs provided include California Children's Services (CCS), Health Care Program for Children in Foster Care (HCPCFC), Child Health Disability Prevention (CHDP) Program, and Childhood lead Poisoning Prevention Program (CLPPP).

CCS, a State-mandated program, determines CCS eligibility for children referred by health care providers, parents, and health plans. CCS Case Management Program provides treatment authorization and medical care coordination for eligible children up to age 21 who are not Medi-Cal Managed Care Plan members. CCS Medical Therapy Program delivers physical and occupational therapy services

to children with certain orthopedic and neurological conditions. HCPCFC works with the County Probation Department and the Child and Family Services Division of the County Department of Social Services to assure children in foster care have timely access to appropriate health care services. CHDP provides no-cost health assessments and dental screenings for Medi-Cal eligible children up to 21 years of age and children under 200% of the poverty level up to age 19. CHDP provides training and technical assistance to enrolled providers, and assures children receive follow-up treatment services. CLPPP educates medical providers in detecting and preventing lead poisoning in children, improves lead poisoning detection by assuring at-risk children receive blood lead screening tests, case manages lead-poisoned children to assure screening follow-up, and maintains a system to collect, analyze and disseminate childhood lead poisoning data that is used for program planning, evaluation.

Recommended FY 2023-24 Positions

Classification Code	Classification Label	FTE
25G21	CA CHILDRENS SERVICES CASE WORKER II	3.00
50F23	OCCUPATIONAL THERAPIST-PHYSICALLY HANDICAPPED CHILDREN	3.40
50G23	PHYSICAL THERAPIST-PHYSICALLY HANDICAPPED CHILDREN	3.65
50G25	SENIOR THERAPIST-PHYSICALLY HANDICAPPED CHILDREN	1.80
50G31	SUPERVISING THERAPIST-MED THER PROG	1.00

Recommended FY 2023-24 Positions

Classification Code	Classification Label	FTE
50J11	CHRONIC DISEASE PREVENTION SPECIALIST II	1.00
50K19	HEALTH EDUCATION ASSISTANT	1.00
52E22	PUBLIC HEALTH NURSE II	6.00
52E23	PUBLIC HEALTH NURSE III	1.00
52E80	SUPERVISING PUBLIC HEALTH NURSE	1.75
54B12	CONTRACT PHYSICIAN	0.45
60P22	COMMUNITY SERVICE AIDE III	3.00
80E22	OFFICE ASSISTANT III	2.00
	Total	29.05

Community Health Regional Teams

(Budget Unit 8123—Fund 001—Appropriation Unit HEA003)

Use of Funds

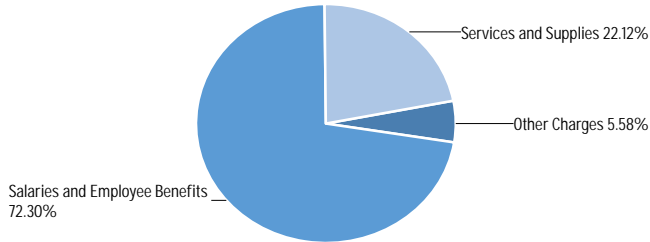

Source of Funds

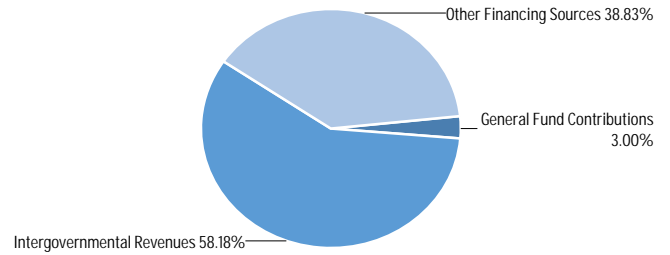

Use of Funds

Expenditures	Prior Year 2021-2022	Adopted Budget 2022-2023	CY Estimate 2022-2023	Requested Budget 2023-2024	Recommended Budget 2023-2024	Recommended Change from Adopted
Salaries and Employee Benefits	\$1,269,484	\$1,598,262	\$1,314,061	\$1,718,372	\$1,718,372	\$120,110
Services and Supplies	\$306,128	\$573,997	\$569,249	\$525,700	\$525,700	\$(48,297)
Other Charges	\$93,548	\$82,416	\$90,252	\$132,740	\$132,740	\$50,324
Subtotal	\$1,669,161	\$2,254,675	\$1,973,562	\$2,376,812	\$2,376,812	\$122,137

Source of Funds

Revenues	Prior Year 2021-2022	Adopted Budget 2022-2023	CY Estimate 2022-2023	Requested Budget 2023-2024	Recommended Budget 2023-2024	Recommended Change from Adopted
Intergovernmental Revenues	\$563,546	\$1,150,424	\$598,864	\$1,382,817	\$1,382,817	\$232,393
Other Financing Sources	\$500,000	\$1,084,675	\$1,354,851	\$922,809	\$922,809	\$(161,866)
Subtotal	\$1,063,546	\$2,235,099	\$1,953,715	\$2,305,626	\$2,305,626	\$70,527
General Fund Contributions	\$605,615	\$19,576	\$19,847	\$71,186	\$71,186	\$51,610
Total Source of Funds	\$1,669,161	\$2,254,675	\$1,973,562	\$2,376,812	\$2,376,812	\$122,137

Unit Description

The Community Health Regional Teams includes Public Health Nurses, Public Health Nutritionists and support staff which are a part of the Nurse-Family Partnership, a nationally recognized program, provide medical and socio-economic nurse case management for improving life outcomes for first-time mothers and their infants. Public Health Nutritionists and support staff provide case management and nutritional evaluation and assistance. These targeted services are provided to families, children under age 21, medically

fragile individuals, individuals at risk of institutionalization and individuals in jeopardy of negative health or psycho-social outcomes.

Recommended FY 2023-24 Positions

Classification Code	Classification Label	FTE
50L22	PUBLIC HEALTH NUTRITIONIST II	4.00
52E22	PUBLIC HEALTH NURSE II	5.00
52E80	SUPERVISING PUBLIC HEALTH NURSE	2.00
Total		11.00

Public Health

(Budget Unit 8124—Fund 001—Appropriation Unit HEA003)

Use of Funds

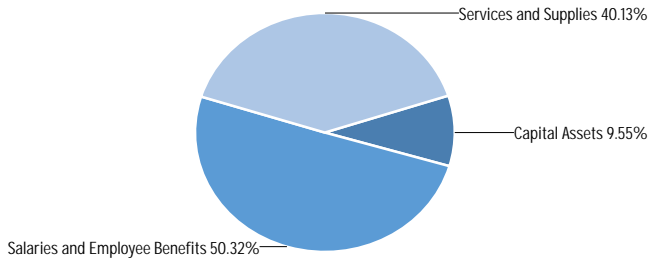

Source of Funds

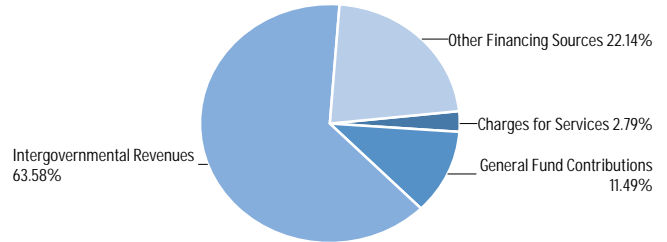

Use of Funds

Expenditures	Prior Year 2021-2022	Adopted Budget 2022-2023	CY Estimate 2022-2023	Requested Budget 2023-2024	Recommended Budget 2023-2024	Recommended Change from Adopted
Salaries and Employee Benefits	\$16,352,899	\$24,911,932	\$19,286,282	\$22,532,924	\$22,532,924	\$(2,379,008)
Services and Supplies	\$11,608,726	\$18,252,337	\$9,834,943	\$19,336,479	\$17,970,353	\$(281,984)
Other Charges	\$(1,882,559)	\$(2,063,537)	\$(1,932,836)	\$(1,505,658)	\$(1,505,658)	\$557,879
Capital Assets	\$89,670	\$2,595,005	\$4,709,425	\$4,274,582	\$4,274,582	\$1,679,577
Subtotal	\$26,168,736	\$43,695,737	\$31,897,814	\$44,638,327	\$43,272,201	\$(423,536)

Source of Funds

Revenues	Prior Year 2021-2022	Adopted Budget 2022-2023	CY Estimate 2022-2023	Requested Budget 2023-2024	Recommended Budget 2023-2024	Recommended Change from Adopted
Licenses, Permits, and Franchises	\$35,696	\$37,364	\$37,481	\$39,355	\$39,355	\$1,991
Fines, Forfeitures, and Penalties	\$12,014	\$9,052	\$11,413	\$10,813	\$10,813	\$1,761
Intergovernmental Revenues	\$12,132,022	\$27,572,797	\$15,851,098	\$27,481,521	\$27,481,521	\$(91,276)
Charges for Services	\$1,311,287	\$940,117	\$1,135,882	\$1,206,174	\$1,206,174	\$266,057
Other Financing Sources	\$4,896,561	\$9,231,101	\$8,956,634	\$9,568,361	\$9,568,361	\$337,260
Subtotal	\$18,387,580	\$37,790,431	\$25,992,508	\$38,306,224	\$38,306,224	\$515,793
General Fund Contributions	\$7,781,156	\$5,905,306	\$5,905,306	\$6,332,103	\$4,965,977	\$(939,329)
Total Source of Funds	\$26,168,736	\$43,695,737	\$31,897,814	\$44,638,327	\$43,272,201	\$(423,536)

Unit Description

Public health is credited with adding 25 years to the life expectancy of people in the United States. Major public health accomplishments in the last 100 years that have prolonged life expectancy include vaccinations, motor vehicle safety laws, safer workplaces, safer drinking water, infectious disease control, healthier food, and alcohol and tobacco laws. Public Health Bureau is organized into five divisions. Communicable Disease Prevention and Control Division monitors reportable diseases such as tuberculosis, HIV, syphilis, hepatitis A, COVID-19, influenza and Valley Fever, investigates suspected outbreaks, and takes measures to reduce the future spread of disease. Public Health Preparedness prepares Health Department employees to respond effectively to emergencies and disasters such as pandemics, floods, and forest fires, while enhancing hospital

emergency response capability. Immunization program collaborates with schools and health care providers to vaccinate children against deadly illnesses. Vital Records Office registers live births and deaths in Monterey County, issues certificates of birth and death, and issues burial and cremation permits. Public Health Laboratories provide local testing to protect our community against public health threats. The Clinical Laboratory receives samples from local hospitals and health care providers to test for infectious diseases such as Norovirus, E. coli and Salmonella. The Environmental Laboratory receives samples from Environmental Health, businesses and residents to test for contaminants in drinking water, wastewater and recreational water such as beaches and lakes. Community Based Nursing Division promotes comprehensive perinatal services for pregnant women, provides case management for mothers and their babies, and links families to services and resources that reduces the number of babies

that die before the age of one. Enhanced Case Management nurses also case manage persons experiencing homelessness, high utilizers of the hospital, and persons with substance use disorders which involves referrals to housing services, drug treatment and medical homes, all of which improve a person’s health and social well-being. Nurse Family Partnership and Public Health Nutrition services are budgeted in Unit 8123. Chronic Disease and Injury Prevention Division works in schools to prevent teen pregnancy, sexually transmitted infections, and abusive relationships. Prevention also works with health care providers and schools to promote oral health by preventing childhood gum disease and cavities. The Division collaborates with cities to reduce motor vehicle, bicyclist and pedestrian injuries and deaths, and supports businesses to reduce youth access to alcohol, cannabis, and tobacco products. Women, Infants and Children (WIC) program provides supplemental food, health care referrals, and nutrition education for low-income pregnant, breastfeeding, and non-breastfeeding postpartum women. Monterey County Employee Wellness Program improves county employee social, emotional, and physical health, which improves staff morale and productivity, reduces absenteeism, reduces worker’s compensation claims, and can reduce health insurance and disability premium rates. Children’s Medical Services Division is budgeted in Unit 8121.

Recommended FY 2023-24 Positions

Classification Code	Classification Label	FTE
12E04	BUREAU CHIEF	1.00
14C30	MANAGEMENT ANALYST II	3.00
14C31	MANAGEMENT ANALYST III	1.00
14C48	PUBLIC HEALTH PROGRAM MANAGER II	2.00
14C80	PUBLIC HEALTH PROGRAM MANAGER I	1.00
14G02	MANAGEMENT ANALYST I	1.00
14K44	ASSISTANT BUREAU CHIEF	1.00
20B11	ACCOUNTANT II	4.00
20B12	ACCOUNTANT III	1.00
20B93	FINANCE MANAGER II	1.00
43B02	WATER QUALITY SPECIALIST	1.00
50C22	PUBLIC HEALTH MICROBIOLOGIST II	3.00
50C23	SENIOR PUBLIC HEALTH MICROBIOLOGIST	1.00
50C70	ASSISTANT DIRECTOR - PUBLIC HEALTH LABORATORY	1.00

Recommended FY 2023-24 Positions

Classification Code	Classification Label	FTE
50C80	DIRECTOR PUBLIC HEALTH LABORATORY	1.00
50C81	PUBLIC HEALTH CHEMIST	1.00
50E23	LABORATORY ASSISTANT	3.00
50J01	CHRONIC DISEASE PREVENTION SPECIALIST I	24.00
50J11	CHRONIC DISEASE PREVENTION SPECIALIST II	9.00
50J21	CHRONIC DISEASE PREVENTION COORDINATOR	9.00
50K18	HEALTH PROGRAM COORDINATOR	4.00
50K23	SENIOR HEALTH EDUCATOR	1.00
50L80	SUPERVISING PUBLIC HEALTH NUTRITIONIST	3.00
50N11	PUBLIC HEALTH EPIDEMIOLOGIST II	2.00
50N22	SUPERVISING PUBLIC HEALTH EPIDEMIOLOGIST	1.00
50U16	BEHAVIORAL HEALTH AIDE	7.00
52A97	CLINIC NURSE PRACTITIONER	1.00
52E01	PUBLIC HEALTH LICENSED VOCATIONAL NURSE	12.00
52E20	DIRECTOR OF PUBLIC HEALTH NURSING	1.00
52E22	PUBLIC HEALTH NURSE II	15.00
52E23	PUBLIC HEALTH NURSE III	2.00
52E80	SUPERVISING PUBLIC HEALTH NURSE	6.00
54B12	CONTRACT PHYSICIAN	0.15
60C21	SOCIAL WORKER II	1.00
60C80	SOCIAL WORK SUPERVISOR I	1.00
60P21	COMMUNITY SERVICE AIDE II	27.00
60P22	COMMUNITY SERVICE AIDE III	2.00
60P23	COMMUNITY SERVICE AIDE IV	4.00
80E22	OFFICE ASSISTANT III	10.00
80E93	SUPERVISING VITAL RECORDS SPECIALIST	1.00
80J22	SENIOR ACCOUNT CLERK	1.00
80J30	ACCOUNTING TECHNICIAN	2.00
Total		173.15

Drinking Water Protection

(Budget Unit 8272—Fund 001—Appropriation Unit HEA005)

Use of Funds

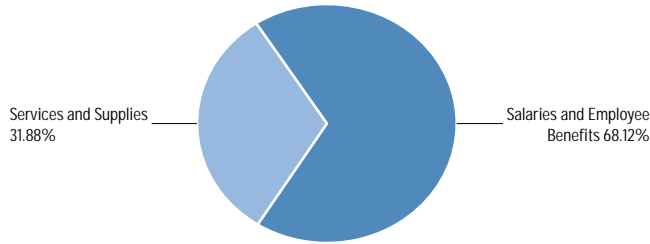

Source of Funds

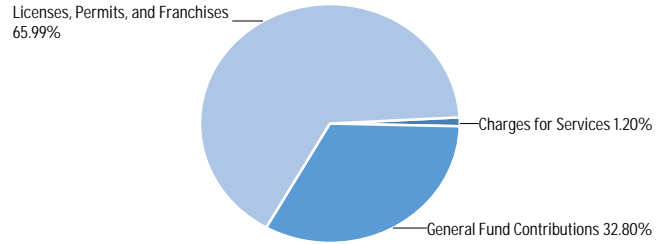

Use of Funds

Expenditures	Prior Year 2021-2022	Adopted Budget 2022-2023	CY Estimate 2022-2023	Requested Budget 2023-2024	Recommended Budget 2023-2024	Recommended Change from Adopted
Salaries and Employee Benefits	\$950,015	\$1,649,203	\$1,276,894	\$1,682,009	\$1,682,009	\$32,806
Services and Supplies	\$570,009	\$551,015	\$729,006	\$787,023	\$787,023	\$236,008
Subtotal	\$1,520,024	\$2,200,218	\$2,005,900	\$2,469,032	\$2,469,032	\$268,814

Source of Funds

Revenues	Prior Year 2021-2022	Adopted Budget 2022-2023	CY Estimate 2022-2023	Requested Budget 2023-2024	Recommended Budget 2023-2024	Recommended Change from Adopted
Licenses, Permits, and Franchises	\$1,519,089	\$1,366,826	\$1,315,000	\$1,629,377	\$1,629,377	\$262,551
Intergovernmental Revenues	—	\$1	\$1	\$1	\$1	—
Charges for Services	\$44,158	\$30,001	\$25,001	\$29,701	\$29,701	\$(300)
Miscellaneous Revenues	\$18,602	\$2	\$2	\$2	\$2	—
Subtotal	\$1,581,850	\$1,396,830	\$1,340,004	\$1,659,081	\$1,659,081	\$262,251
Restricted Fund Balance	—	—	—	\$221,414	\$221,414	\$221,414
General Fund Contributions	\$(61,826)	\$803,388	\$665,896	\$588,537	\$588,537	\$(214,851)
Total Source of Funds	\$1,520,024	\$2,200,218	\$2,005,900	\$2,469,032	\$2,469,032	\$268,814

Unit Description

Drinking Water Protection Services (DWPS) is responsible for permitting, inspection and enforcement of over 1,250 water systems in the County. DWPS provides assistance to non-State regulated public and private potable water distribution systems to comply with local, state and federal regulations, and to resolve water quality and quantity issues. DWPS permits all water well construction, repair and destruction activities in the County; operates a cross-connection control program and a water reuse program; and permits and inspects desalination treatment facilities. Additionally, DWPS issues all hazardous materials monitoring well construction, destruction and soil boring permits and inspections. DWPS is the Local Primacy Agency (LPA) for the State Water Resource Control Board for the regulation of small public water systems.

Recommended FY 2023-24 Positions

Classification Code	Classification Label	FTE
30J01	ENVIRONMENTAL HEALTH TECHNICIAN	1.00
30J21	ENVIRONMENTAL HEALTH SPECIALIST II	6.00
30J31	ENVIRONMENTAL HEALTH SPECIALIST III	3.00
30J84	ENVIRONMENTAL HEALTH SPECIALIST IV	2.00
Total		12.00

Behavioral Health

(Budget Unit 8410—Fund 022—Appropriation Unit HEA015)

Use of Funds

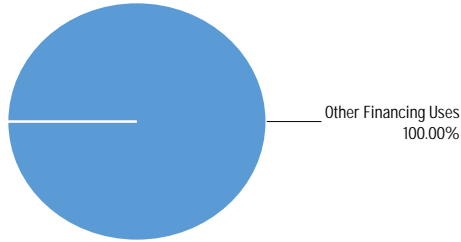

Source of Funds

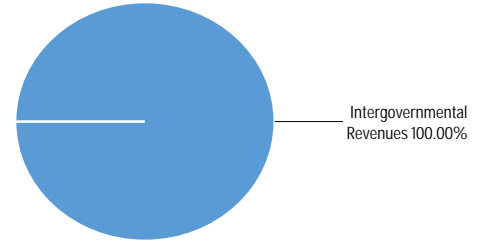

Use of Funds

Expenditures	Prior Year 2021-2022	Adopted Budget 2022-2023	CY Estimate 2022-2023	Requested Budget 2023-2024	Recommended Budget 2023-2024	Recommended Change from Adopted
Other Financing Uses	\$17,660,926	\$21,764,942	\$21,764,942	\$29,305,772	\$29,305,772	\$7,540,830
Subtotal	\$17,660,926	\$21,764,942	\$21,764,942	\$29,305,772	\$29,305,772	\$7,540,830

Source of Funds

Revenues	Prior Year 2021-2022	Adopted Budget 2022-2023	CY Estimate 2022-2023	Requested Budget 2023-2024	Recommended Budget 2023-2024	Recommended Change from Adopted
Intergovernmental Revenues	\$28,520,504	\$21,764,942	\$27,132,949	\$29,305,772	\$29,305,772	\$7,540,830
Subtotal	\$28,520,504	\$21,764,942	\$27,132,949	\$29,305,772	\$29,305,772	\$7,540,830
Fund Balance	\$(10,859,578)	—	\$(5,368,007)	—	—	—
Total Source of Funds	\$17,660,926	\$21,764,942	\$21,764,942	\$29,305,772	\$29,305,772	\$7,540,830

Unit Description

The Local Revenue Fund, Fund 022, was established in FY 2011-12 pursuant to AB 118, to recognize and track non-health and social services sales tax revenue and vehicle license fee realignment funds. For consistency in the treatment of 2011 revenue, effective in March

2015, recognition and tracking of Behavioral Health Sub-account revenue receipts was transferred to Fund 022. The Recommended Budget of \$29,305,772 represents the estimated revenue available to fund eligible expenditures during the budget year.

Behavioral Health

(Budget Unit 8410—Fund 023—Appropriation Unit HEA012)

Use of Funds

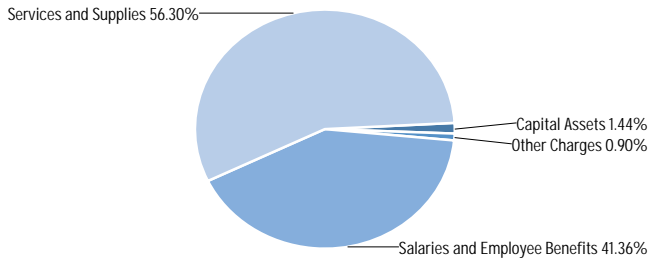

Source of Funds

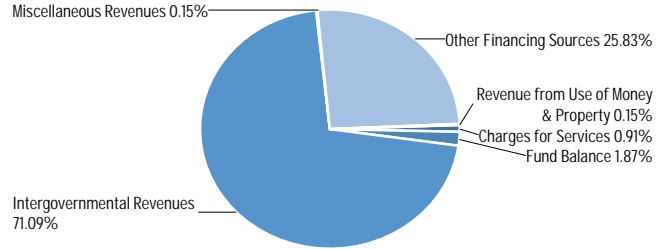

Use of Funds

Expenditures	Prior Year 2021-2022	Adopted Budget 2022-2023	CY Estimate 2022-2023	Requested Budget 2023-2024	Recommended Budget 2023-2024	Recommended Change from Adopted
Salaries and Employee Benefits	\$52,684,213	\$61,688,945	\$56,259,509	\$67,234,710	\$67,234,710	\$5,545,765
Services and Supplies	\$74,858,791	\$89,193,496	\$82,466,075	\$91,523,274	\$91,523,274	\$2,329,778
Other Charges	\$2,528,694	\$1,369,532	\$1,873,574	\$1,463,761	\$1,463,761	\$94,229
Capital Assets	\$2,579,505	\$846,371	\$2,054,884	\$2,332,695	\$2,332,695	\$1,486,324
Other Financing Uses	\$3,902,864	—	—	—	—	—
Subtotal	\$136,554,068	\$153,098,344	\$142,654,042	\$162,554,440	\$162,554,440	\$9,456,096

Source of Funds

Revenues	Prior Year 2021-2022	Adopted Budget 2022-2023	CY Estimate 2022-2023	Requested Budget 2023-2024	Recommended Budget 2023-2024	Recommended Change from Adopted
Fines, Forfeitures, and Penalties	\$123,112	\$78,090	\$100,000	\$115,000	\$115,000	\$36,910
Revenue from Use of Money & Property	\$233,051	\$238,900	\$243,900	\$238,993	\$238,993	\$93
Intergovernmental Revenues	\$113,495,028	\$114,686,761	\$103,741,437	\$115,473,860	\$115,473,860	\$787,099
Charges for Services	\$1,197,225	\$1,469,241	\$1,993,435	\$1,483,092	\$1,483,092	\$13,851
Miscellaneous Revenues	\$1,132,049	\$200,000	\$276,716	\$250,000	\$250,000	\$50,000
Other Financing Sources	\$29,966,358	\$33,606,114	\$33,606,114	\$41,961,516	\$41,961,516	\$8,355,402
Subtotal	\$146,146,822	\$150,279,106	\$139,961,602	\$159,522,461	\$159,522,461	\$9,243,355
Fund Balance	\$(9,592,755)	\$2,819,238	\$2,692,440	\$3,031,979	\$3,031,979	\$212,741
Total Source of Funds	\$136,554,068	\$153,098,344	\$142,654,042	\$162,554,440	\$162,554,440	\$9,456,096

Unit Description

Pursuant to Welfare and Institutions Code Section 5600, the Behavioral Health Bureau provides a continuum of County operated and community-based substance use disorder and mental health services. The program provides community prevention programs, crisis intervention, inpatient psychiatric services, social rehabilitation, supportive housing, and outpatient services primarily to Monterey County Medi-Cal beneficiaries who meet the State Department of Health Care Services, Mental Health Division's medical necessity criteria. In addition, the program also serves many non-Medi-Cal eligible residents who have behavioral health disorders. For instance, the program serves non-Medi-Cal eligible children who meet the Seriously Emotionally Disturbed definition under the newly created

Education-Related Mental Health Services Program. The passage of AB 100 realignment and the restructuring of the State Departments of Mental Health and Alcohol and Drugs resulted in a significant transition of Behavioral Health Services from the State to counties.

Behavioral Health Administration provides administrative support to both Mental Health and Substance Use Disorder Programs. This unit includes: Quality Management for Medi-Cal and non-Medi-Cal clinical services; budget preparation, management, and monitoring; accounts receivable/payable; Medi-Cal billing; electronic health records maintenance; information technology support; grants management; contract management; housing projects administration; capital projects development and coordination; workforce education and training coordination; human resources services; purchasing; and executive management.

Recommended FY 2023-24 Positions

Classification Code	Classification Label	FTE
12E04	BUREAU CHIEF	1.00
14C30	MANAGEMENT ANALYST II	12.00
14C31	MANAGEMENT ANALYST III	5.00
14K41	BEHAVIORAL HEALTH SERVICES MANAGER II	16.00
14K44	ASSISTANT BUREAU CHIEF	1.00
20B10	ACCOUNTANT I	1.00
20B11	ACCOUNTANT II	1.00
20B12	ACCOUNTANT III	4.00
20B93	FINANCE MANAGER II	1.00
20B95	FINANCE MANAGER I	1.00
43J04	DEPARTMENTAL INFORMATION SYSTEMS SPECIALIST	4.00
43J05	DEPARTMENTAL INFORMATION SYSTEMS COORDINATOR	3.00
43J15	SUPERVISING DEPARTMENTAL INFORMATION SYSTEMS COORDINATOR	1.00
50F20	OCCUPATIONAL THERAPIST	1.00
50J21	CHRONIC DISEASE PREVENTION COORDINATOR	2.00
50N11	PUBLIC HEALTH EPIDEMIOLOGIST II	1.00
50T01	MEDICAL RECORD TECHNICIAN I	2.00
50U16	BEHAVIORAL HEALTH AIDE	18.10
50U42	MEDICAL ASSISTANT	24.00
52A94	PSYCHIATRIC NURSE PRACTITIONER	3.00
52E01	PUBLIC HEALTH LICENSED VOCATIONAL NURSE	9.00
54B12	CONTRACT PHYSICIAN	18.00
54C05	PSYCHIATRIC PHYSICIAN ASSISTANT	1.00

Recommended FY 2023-24 Positions

Classification Code	Classification Label	FTE
60A21	CLINICAL PSYCHOLOGIST	12.00
60B21	PSYCHIATRIC SOCIAL WORKER II	182.00
60B23	BEHAVIORAL HEALTH UNIT SUPERVISOR	35.00
60B25	SENIOR PSYCHIATRIC SOCIAL WORKER	35.00
60C22	SOCIAL WORKER III	56.00
60I10	DEPUTY DIRECTOR BEHAVIORAL HEALTH	4.00
60L01	PATIENT RIGHTS ADVOCATE	1.00
80A31	SECRETARY	1.00
80A32	SENIOR SECRETARY	3.00
80E21	OFFICE ASSISTANT II	2.00
80E22	OFFICE ASSISTANT III	4.00
80J22	SENIOR ACCOUNT CLERK	1.00
80J30	ACCOUNTING TECHNICIAN	2.00
80K25	CLINIC OPERATIONS SUPERVISOR	3.00
80L02	PATIENT SERVICES REPRESENTATIVE II	22.00
80L03	SENIOR PATIENT SERVICES REPRESENTATIVE	1.00
80L04	SUPERVISING PATIENT SERVICES REPRESENTATIVE	3.00
80M02	PATIENT FINANCIAL SERVICES SPECIALIST II	4.00
80M03	SENIOR PATIENT FINANCIAL SERVICES SPECIALIST	1.00
80M04	SUPERVISING PATIENT FINANCIAL SERVICES SPECIALIST	1.00
Total		503.10

Behavioral Health

(Budget Unit 8410—Fund 025—Appropriation Unit HEA016)

Use of Funds

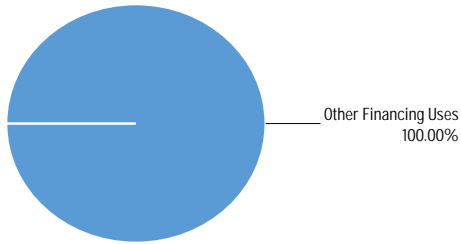

Source of Funds

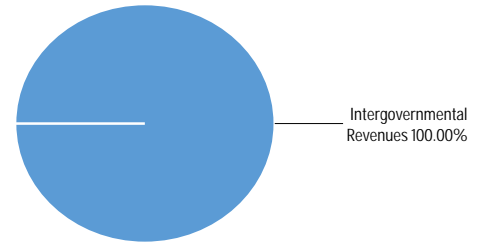

Use of Funds

Expenditures	Prior Year 2021-2022	Adopted Budget 2022-2023	CY Estimate 2022-2023	Requested Budget 2023-2024	Recommended Budget 2023-2024	Recommended Change from Adopted
Other Financing Uses	\$10,300,720	\$10,301,721	\$10,301,721	\$10,301,721	\$10,301,721	—
Subtotal	\$10,300,720	\$10,301,721	\$10,301,721	\$10,301,721	\$10,301,721	—

Source of Funds

Revenues	Prior Year 2021-2022	Adopted Budget 2022-2023	CY Estimate 2022-2023	Requested Budget 2023-2024	Recommended Budget 2023-2024	Recommended Change from Adopted
Intergovernmental Revenues	\$11,464,783	\$10,301,721	\$10,301,721	\$10,301,721	\$10,301,721	—
Subtotal	\$11,464,783	\$10,301,721	\$10,301,721	\$10,301,721	\$10,301,721	—
Fund Balance	\$(1,164,062)	—	—	—	—	—
Total Source of Funds	\$10,300,720	\$10,301,721	\$10,301,721	\$10,301,721	\$10,301,721	—

Unit Description

The Health & Welfare Realignment Fund, Fund 025, was established in FY 2012-13 to comply with new 1991 Realignment accounting and funding methodologies adopted by the State. Fund 025 serves as the repository and appropriation unit for all realignment funds. Effective

March 2015, the recognition and tracking of 1991 realignment receipts for Mental Health was transferred to Fund 025. The Recommended Budget of \$10,301,172 represents the estimated revenue available to fund eligible expenditures during the budget year.

Health Realignment

(Budget Unit 8424—Fund 025—Appropriation Unit HEA013)

Use of Funds

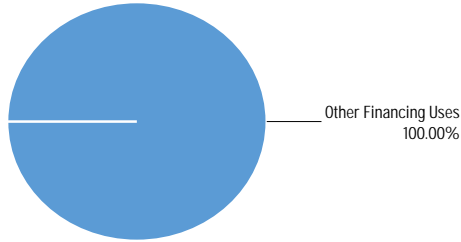

Source of Funds

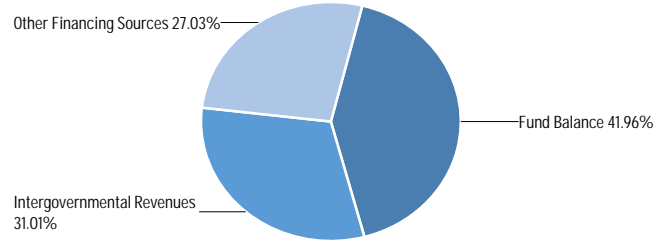

Use of Funds

Expenditures	Prior Year 2021-2022	Adopted Budget 2022-2023	CY Estimate 2022-2023	Requested Budget 2023-2024	Recommended Budget 2023-2024	Recommended Change from Adopted
Other Financing Uses	\$8,752,542	\$12,575,837	\$12,575,837	\$19,379,367	\$19,379,367	\$6,803,530
Subtotal	\$8,752,542	\$12,575,837	\$12,575,837	\$19,379,367	\$19,379,367	\$6,803,530

Source of Funds

Revenues	Prior Year 2021-2022	Adopted Budget 2022-2023	CY Estimate 2022-2023	Requested Budget 2023-2024	Recommended Budget 2023-2024	Recommended Change from Adopted
Intergovernmental Revenues	\$9,215,786	\$6,377,855	\$5,729,536	\$6,008,953	\$6,008,953	\$(368,902)
Other Financing Sources	\$5,239,014	\$5,336,288	\$5,239,014	\$5,239,014	\$5,239,014	\$(97,274)
Subtotal	\$14,454,800	\$11,714,143	\$10,968,550	\$11,247,967	\$11,247,967	\$(466,176)
Fund Balance	\$(5,702,258)	\$861,694	\$1,607,287	\$8,131,400	\$8,131,400	\$7,269,706
Total Source of Funds	\$8,752,542	\$12,575,837	\$12,575,837	\$19,379,367	\$19,379,367	\$6,803,530

Unit Description

The Health & Welfare Realignment Fund 025 was established in FY 2012-13 to comply with new 1991 realignment accounting and funding methodologies adopted by the State. Fund 025 will serve as the repository and appropriation unit for realignment funds.

Total expenditures of \$19,379,367 are categorized as follows: \$2,450,645 for Sheriff's Office inmate medical care, \$500,000 for debt service for the Health Building, \$1,215,998 for Policy

Evaluation and Planning Unit (PEP), \$157,000 for Enhanced Care Management (ECM), \$38,000 for Medi-Cal Coordination (MAA/TCM), \$60,000 for indigent medical services to rural clinics, \$557,409 for Animal Services, \$1,218,318 Children's Medical Services, \$6,737,298 for Public Health programs and services, \$5,894,699 for AB 85 one-time payment, and \$550,000 for Participatory Budget services.

Health Dept. Administration

(Budget Unit 8438—Fund 001—Appropriation Unit HEA014)

Use of Funds

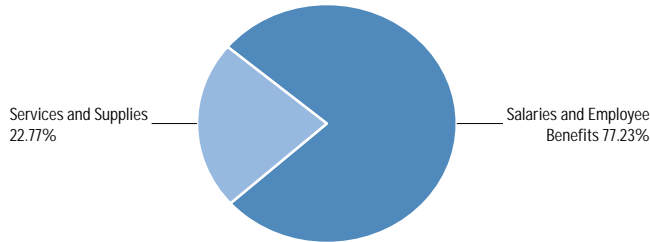

Source of Funds

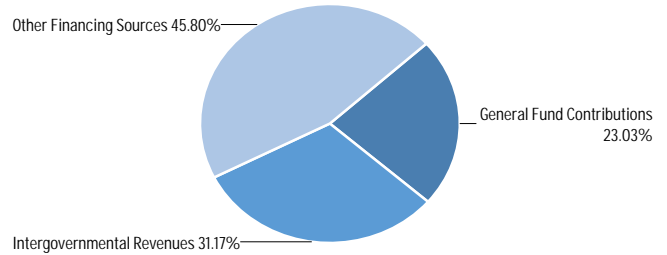

Use of Funds

Expenditures	Prior Year 2021-2022	Adopted Budget 2022-2023	CY Estimate 2022-2023	Requested Budget 2023-2024	Recommended Budget 2023-2024	Recommended Change from Adopted
Salaries and Employee Benefits	\$8,401,054	\$10,037,407	\$8,800,053	\$12,222,096	\$12,222,096	\$2,184,689
Services and Supplies	\$4,168,887	\$5,715,153	\$5,488,818	\$3,604,041	\$3,604,041	\$(2,111,112)
Other Charges	\$(6,804,479)	\$(7,242,756)	\$(6,970,612)	\$(9,148,626)	\$(9,148,626)	\$(1,905,870)
Capital Assets	\$277,547	—	\$10,000	—	—	—
Other Financing Uses	\$2,050,000	—	—	—	—	—
Subtotal	\$8,093,009	\$8,509,804	\$7,328,259	\$6,677,511	\$6,677,511	\$(1,832,293)

Source of Funds

Revenues	Prior Year 2021-2022	Adopted Budget 2022-2023	CY Estimate 2022-2023	Requested Budget 2023-2024	Recommended Budget 2023-2024	Recommended Change from Adopted
Intergovernmental Revenues	\$1,641,852	\$4,227,799	\$4,055,134	\$2,081,679	\$2,081,679	\$(2,146,120)
Charges for Services	\$51,650	\$71,491	\$82,000	—	—	\$(71,491)
Other Financing Sources	\$746,000	\$1,218,975	\$199,585	\$3,058,050	\$3,058,050	\$1,839,075
Subtotal	\$2,439,502	\$5,518,265	\$4,336,719	\$5,139,729	\$5,139,729	\$(378,536)
General Fund Contributions	\$5,653,507	\$2,991,539	\$2,991,540	\$1,537,782	\$1,537,782	\$(1,453,757)
Total Source of Funds	\$8,093,009	\$8,509,804	\$7,328,259	\$6,677,511	\$6,677,511	\$(1,832,293)

Unit Description

Health Department Administration Bureau provides operating Bureaus/Divisions with infrastructure and support services. These services include; departmentwide administration, budget, and accounting oversight, human resources services, management information systems support, program evaluation and data analyses for health policy and program development and monitoring, management of public health accreditations processes, and facilities management.

Recommended FY 2023-24 Positions

Classification Code	Classification Label	FTE
11A09	DIRECTOR HEALTH SERVICES	1.00
12C05	ASSISTANT DIRECTOR OF HEALTH SERVICES	1.00
14A10	PROJECT MANAGER I	1.00
14B21	ASSOCIATE PERSONNEL ANALYST	6.00
14B32	SENIOR PERSONNEL ANALYST	3.00
14B66	DEPARTMENTAL HR MANAGER	1.00
14C30	MANAGEMENT ANALYST II	6.50
14C31	MANAGEMENT ANALYST III	5.00
14C48	PUBLIC HEALTH PROGRAM MANAGER II	1.00
14C80	PUBLIC HEALTH PROGRAM MANAGER I	1.00

Recommended FY 2023-24 Positions

Classification Code	Classification Label	FTE
14H03	PERSONNEL TECHNICIAN- CONFIDENTIAL	6.00
14N06	OPERATIONS MANAGER	1.00
16C87	BUSINESS TECHNOLOGY ANALYST II	2.00
16C88	BUSINESS TECHNOLOGY ANALYST III	2.00
16C93	BUSINESS TECHNOLOGY ANALYST IV	3.00
16F41	DEPARTMENTAL INFORMATION SYSTEMS MANAGER II	1.00
20B11	ACCOUNTANT II	1.00
20B12	ACCOUNTANT III	1.00
20B93	FINANCE MANAGER II	1.00
20B94	FINANCE MANAGER III	1.00
43J05	DEPARTMENTAL INFORMATION SYSTEMS COORDINATOR	3.00
43J09	SENIOR DEPARTMENTAL INFORMATION SYSTEMS COORDINATOR	2.00
43J15	SUPERVISING DEPARTMENTAL INFORMATION SYSTEMS COORDINATOR	1.00
50J11	CHRONIC DISEASE PREVENTION SPECIALIST II	3.00
50J21	CHRONIC DISEASE PREVENTION COORDINATOR	5.00
50N11	PUBLIC HEALTH EPIDEMIOLOGIST II	2.00
50N22	SUPERVISING PUBLIC HEALTH EPIDEMIOLOGIST	1.00
60P22	COMMUNITY SERVICE AIDE III	2.00
72A23	BUILDING MAINTENANCE WORKER	1.00
72A81	BUILDING MAINTENANCE SUPERVISOR	1.00
80A99	ADMINISTRATIVE SECRETARY- CONFIDENTIAL	1.00
80E21	OFFICE ASSISTANT II	1.00
80E22	OFFICE ASSISTANT III	1.00
80J20	ACCOUNTING CLERICAL SUPERVISOR	1.00
80J22	SENIOR ACCOUNT CLERK	1.00
80J30	ACCOUNTING TECHNICIAN	5.00
80U21	TELEPHONE OPERATOR	1.00
	Total	77.50

Animal Services

(Budget Unit 8442—Fund 001—Appropriation Unit HEA001)

Use of Funds

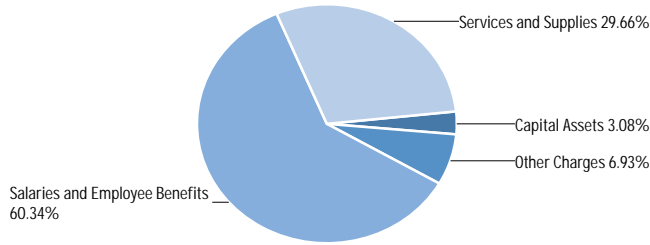

Source of Funds

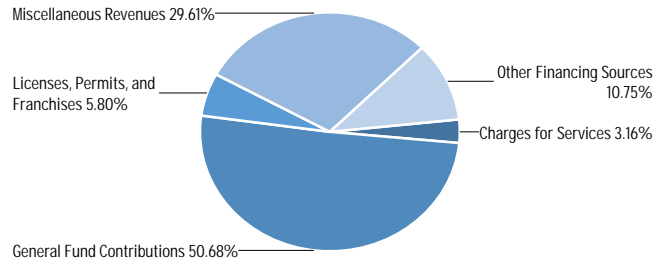

Use of Funds

Expenditures	Prior Year 2021-2022	Adopted Budget 2022-2023	CY Estimate 2022-2023	Requested Budget 2023-2024	Recommended Budget 2023-2024	Recommended Change from Adopted
Salaries and Employee Benefits	\$1,922,668	\$3,070,202	\$2,757,314	\$3,130,567	\$3,130,567	\$60,365
Services and Supplies	\$1,032,015	\$1,308,699	\$1,432,890	\$1,779,096	\$1,539,096	\$230,397
Other Charges	\$465,030	\$446,953	\$446,953	\$359,338	\$359,338	\$(87,615)
Capital Assets	—	—	\$195,500	\$934,575	\$159,600	\$159,600
Subtotal	\$3,419,713	\$4,825,854	\$4,832,657	\$6,203,576	\$5,188,601	\$362,747

Source of Funds

Revenues	Prior Year 2021-2022	Adopted Budget 2022-2023	CY Estimate 2022-2023	Requested Budget 2023-2024	Recommended Budget 2023-2024	Recommended Change from Adopted
Licenses, Permits, and Franchises	\$158,177	\$159,000	\$143,403	\$301,000	\$301,000	\$142,000
Charges for Services	\$264,874	\$122,000	\$168,084	\$164,000	\$164,000	\$42,000
Miscellaneous Revenues	\$641,554	\$1,371,210	\$1,279,856	\$1,632,089	\$1,536,089	\$164,879
Other Financing Sources	—	\$557,698	\$557,698	\$557,698	\$557,698	—
Subtotal	\$1,064,605	\$2,209,908	\$2,149,041	\$2,654,787	\$2,558,787	\$348,879
General Fund Contributions	\$2,355,108	\$2,615,946	\$2,683,616	\$3,548,789	\$2,629,814	\$13,868
Total Source of Funds	\$3,419,713	\$4,825,854	\$4,832,657	\$6,203,576	\$5,188,601	\$362,747

Unit Description

Animal Services provides health protection to the residents of Monterey County through rabies and stray animal control. Animal Services also provides public education, volunteer opportunities, field response for dangerous animals and nuisance complaints, pet licensing, spay and neuter services and shelter for approximately 2,500-3,000 animals annually, which largely consist of animals coming in as stray and roaming animals.

Recommended FY 2023-24 Positions

Classification Code	Classification Label	FTE
14H24	EDUCATOR AND VOLUNTEER COORDINATOR	1.00
34C01	ANIMAL CONTROL OFFICER	5.00
34C02	SENIOR ANIMAL CONTROL OFFICER	1.00
34C11	ANIMAL SERVICES SUPERVISOR	2.00
50M21	REGISTERED VETERINARY TECHNICIAN	1.50
50M80	VETERINARIAN	1.50
70B03	ANIMAL CARE TECHNICIAN II	7.00
70B04	SENIOR ANIMAL CARE TECHNICIAN	1.00
80E01	OFFICE ASSISTANT I	1.00
80E21	OFFICE ASSISTANT II	4.00
80E22	OFFICE ASSISTANT III	1.00
80E80	PRINCIPAL OFFICE ASSISTANT	1.00
Total		27.00

Bienestar Salinas

(Budget Unit 8446—Fund 001—Appropriation Unit HEA007)

Use of Funds

Intentionally Left Blank

Source of Funds

Intentionally Left Blank

Use of Funds

Expenditures	Prior Year 2021-2022	Adopted Budget 2022-2023	CY Estimate 2022-2023	Requested Budget 2023-2024	Recommended Budget 2023-2024	Recommended Change from Adopted
Salaries and Employee Benefits	\$55,038	\$90,961	\$72,686	—	—	\$(90,961)
Services and Supplies	\$21,188	\$21,302	\$40,917	—	—	\$(21,302)
Capital Assets	—	—	\$3,840	—	—	—
Subtotal	\$76,226	\$112,263	\$117,443	—	—	\$(112,263)

Source of Funds

Revenues	Prior Year 2021-2022	Adopted Budget 2022-2023	CY Estimate 2022-2023	Requested Budget 2023-2024	Recommended Budget 2023-2024	Recommended Change from Adopted
Intergovernmental Revenues	\$8,500	—	—	—	—	—
Charges for Services	\$19,299	\$167,027	\$29,882	—	—	\$(167,027)
Subtotal	\$27,799	\$167,027	\$29,882	—	—	\$(167,027)
General Fund Contributions	\$48,427	\$(54,764)	\$87,561	—	—	\$54,764
Total Source of Funds	\$76,226	\$112,263	\$117,443	—	—	\$(112,263)

Unit Description

Effective Fiscal Year 2023-24, this Unit is consolidated in Unit 8592.

Marina Integrative Clinic

(Budget Unit 8447—Fund 001—Appropriation Unit HEA007)

Use of Funds

Intentionally Left Blank

Source of Funds

Intentionally Left Blank

Use of Funds

Expenditures	Prior Year 2021-2022	Adopted Budget 2022-2023	CY Estimate 2022-2023	Requested Budget 2023-2024	Recommended Budget 2023-2024	Recommended Change from Adopted
Salaries and Employee Benefits	\$75,784	\$210,004	\$88,995	—	—	\$(210,004)
Services and Supplies	\$17,354	\$11,830	\$26,574	—	—	\$(11,830)
Capital Assets	—	—	\$3,536	—	—	—
Subtotal	\$93,138	\$221,834	\$119,105	—	—	\$(221,834)

Source of Funds

Revenues	Prior Year 2021-2022	Adopted Budget 2022-2023	CY Estimate 2022-2023	Requested Budget 2023-2024	Recommended Budget 2023-2024	Recommended Change from Adopted
Charges for Services	\$38,120	—	\$48,797	—	—	—
Subtotal	\$38,120	—	\$48,797	—	—	—
General Fund Contributions	\$55,018	\$221,834	\$70,308	—	—	\$(221,834)
Total Source of Funds	\$93,138	\$221,834	\$119,105	—	—	\$(221,834)

Unit Description

Effective Fiscal Year 2023-24, this Unit is consolidated in Unit 8592.

Laurel Vista

(Budget Unit 8448—Fund 001—Appropriation Unit HEA007)

Use of Funds

Source of Funds

Intentionally Left Blank

Intentionally Left Blank

Use of Funds

Expenditures	Prior Year 2021-2022	Adopted Budget 2022-2023	CY Estimate 2022-2023	Requested Budget 2023-2024	Recommended Budget 2023-2024	Recommended Change from Adopted
Salaries and Employee Benefits	\$704,004	\$1,312,642	\$525,288	—	—	\$(1,312,642)
Services and Supplies	\$147,603	\$147,017	\$133,725	—	—	\$(147,017)
Other Charges	\$17,808	\$(6,841)	\$171,339	—	—	\$6,841
Capital Assets	—	—	\$68,269	—	—	—
Subtotal	\$869,416	\$1,452,818	\$898,621	—	—	\$(1,452,818)

Source of Funds

Revenues	Prior Year 2021-2022	Adopted Budget 2022-2023	CY Estimate 2022-2023	Requested Budget 2023-2024	Recommended Budget 2023-2024	Recommended Change from Adopted
Intergovernmental Revenues	\$38,849	\$33,882	\$33,882	—	—	\$(33,882)
Charges for Services	\$686,807	\$1,781,900	\$356,136	—	—	\$(1,781,900)
Other Financing Sources	\$140	—	—	—	—	—
Subtotal	\$725,796	\$1,815,782	\$390,018	—	—	\$(1,815,782)
General Fund Contributions	\$143,620	\$(362,964)	\$508,603	—	—	\$362,964
Total Source of Funds	\$869,416	\$1,452,818	\$898,621	—	—	\$(1,452,818)

Unit Description

Effective Fiscal Year 2023-24, this Unit is consolidated in Unit 8592.

Clinic Services Quality Improvement

(Budget Unit 8449—Fund 001—Appropriation Unit HEA007)

Use of Funds

Source of Funds

Intentionally Left Blank

Intentionally Left Blank

Use of Funds

Expenditures	Prior Year 2021-2022	Adopted Budget 2022-2023	CY Estimate 2022-2023	Requested Budget 2023-2024	Recommended Budget 2023-2024	Recommended Change from Adopted
Salaries and Employee Benefits	\$870,027	\$1,414,193	\$1,115,127	—	—	\$(1,414,193)
Services and Supplies	\$253,714	\$327,755	\$265,830	—	—	\$(327,755)
Capital Assets	—	—	\$500	—	—	—
Subtotal	\$1,123,741	\$1,741,948	\$1,381,457	—	—	\$(1,741,948)

Source of Funds

Revenues	Prior Year 2021-2022	Adopted Budget 2022-2023	CY Estimate 2022-2023	Requested Budget 2023-2024	Recommended Budget 2023-2024	Recommended Change from Adopted
Miscellaneous Revenues	\$6,500	—	—	—	—	—
Subtotal	\$6,500	—	—	—	—	—
General Fund Contributions	\$1,117,241	\$1,741,948	\$1,381,457	—	—	\$(1,741,948)
Total Source of Funds	\$1,123,741	\$1,741,948	\$1,381,457	—	—	\$(1,741,948)

Unit Description

Effective Fiscal Year 2023-24, this Unit is consolidated in Unit 8591.

Customer Service Center

(Budget Unit 8450—Fund 001—Appropriation Unit HEA007)

Use of Funds	Source of Funds
Intentionally Left Blank	Intentionally Left Blank

Use of Funds

Expenditures	Prior Year 2021-2022	Adopted Budget 2022-2023	CY Estimate 2022-2023	Requested Budget 2023-2024	Recommended Budget 2023-2024	Recommended Change from Adopted
Salaries and Employee Benefits	\$1,261,897	\$1,775,723	\$1,641,211	—	—	\$(1,775,723)
Services and Supplies	\$35,972	\$39,581	\$27,838	—	—	\$(39,581)
Capital Assets	—	—	\$4,613	—	—	—
Subtotal	\$1,297,870	\$1,815,304	\$1,673,662	—	—	\$(1,815,304)

Source of Funds

Revenues	Prior Year 2021-2022	Adopted Budget 2022-2023	CY Estimate 2022-2023	Requested Budget 2023-2024	Recommended Budget 2023-2024	Recommended Change from Adopted
General Fund Contributions	\$1,297,870	\$1,815,304	\$1,673,662	—	—	\$(1,815,304)
Total Source of Funds	\$1,297,870	\$1,815,304	\$1,673,662	—	—	\$(1,815,304)

Unit Description

Effective Fiscal Year 2023-24, this Unit is consolidated in Unit 8591.

Whole Person Care

(Budget Unit 8473—Fund 023—Appropriation Unit HEA017)

Use of Funds

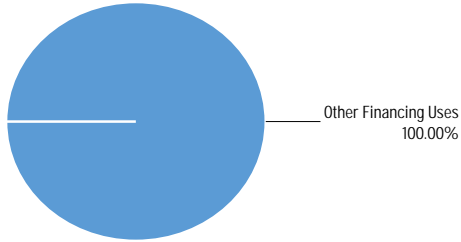

Source of Funds

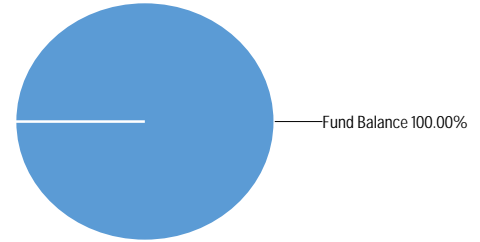

Use of Funds

Expenditures	Prior Year 2021-2022	Adopted Budget 2022-2023	CY Estimate 2022-2023	Requested Budget 2023-2024	Recommended Budget 2023-2024	Recommended Change from Adopted
Other Charges	\$5,320,750	—	—	—	—	—
Other Financing Uses	\$3,788,966	\$4,300,360	\$1,357,712	\$3,825,000	\$3,825,000	\$(475,360)
Subtotal	\$9,109,716	\$4,300,360	\$1,357,712	\$3,825,000	\$3,825,000	\$(475,360)

Source of Funds

Revenues	Prior Year 2021-2022	Adopted Budget 2022-2023	CY Estimate 2022-2023	Requested Budget 2023-2024	Recommended Budget 2023-2024	Recommended Change from Adopted
Intergovernmental Revenues	\$12,147,831	—	—	—	—	—
Subtotal	\$12,147,831	—	—	—	—	—
Fund Balance	\$(3,038,115)	\$4,300,360	\$1,357,712	\$3,825,000	\$3,825,000	\$(475,360)
Total Source of Funds	\$9,109,716	\$4,300,360	\$1,357,712	\$3,825,000	\$3,825,000	\$(475,360)

Unit Description

The unit provides enhanced care coordination services to vulnerable high-cost service utilizers experiencing homelessness and a mental

health or substance abuse disorder. Services are provided in coordination with Public Health, Behavioral Health, Social Services, Natividad Medical Center, and community-based organizations.

CS Administration

(Budget Unit 8591—Fund 001—Appropriation Unit HEA007)

Use of Funds

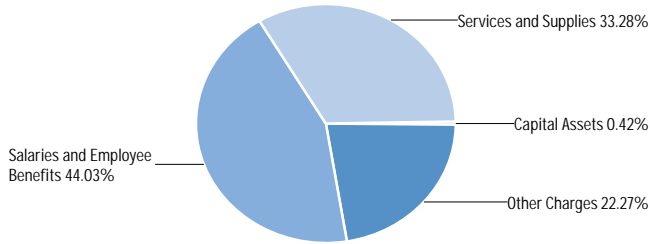

Source of Funds

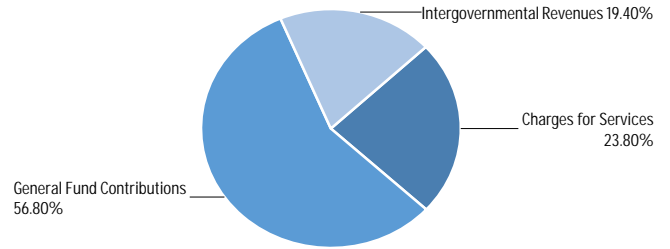

Use of Funds

Expenditures	Prior Year 2021-2022	Adopted Budget 2022-2023	CY Estimate 2022-2023	Requested Budget 2023-2024	Recommended Budget 2023-2024	Recommended Change from Adopted
Salaries and Employee Benefits	—	—	—	\$7,210,577	\$7,210,577	\$7,210,577
Services and Supplies	—	—	—	\$5,450,484	\$5,450,484	\$5,450,484
Other Charges	—	—	—	\$3,647,477	\$3,647,477	\$3,647,477
Capital Assets	—	—	—	\$69,266	\$69,266	\$69,266
Subtotal	—	—	—	\$16,377,804	\$16,377,804	\$16,377,804

Source of Funds

Revenues	Prior Year 2021-2022	Adopted Budget 2022-2023	CY Estimate 2022-2023	Requested Budget 2023-2024	Recommended Budget 2023-2024	Recommended Change from Adopted
Intergovernmental Revenues	—	—	—	\$3,177,904	\$3,177,904	\$3,177,904
Charges for Services	—	—	—	\$3,897,300	\$3,897,300	\$3,897,300
Subtotal	—	—	—	\$7,075,204	\$7,075,204	\$7,075,204
General Fund Contributions	—	—	—	\$9,302,600	\$9,302,600	\$9,302,600
Total Source of Funds	—	—	—	\$16,377,804	\$16,377,804	\$16,377,804

Unit Description

The Clinic Services Administration Unit centralizes all administrative functions necessary for the efficient management of the County-operated Federally Qualified Health Centers (FQHC) clinics, and to maintain and expand FQHC status. The functions encompassed are administration, finance, quality improvement, and the customer service center. Administration provides leadership, administrative support, service delivery and strategic planning, contracting, and provider credentialing. Finance is responsible for fiscal reporting and oversight, and for all medical payor and patient billing, and processes applications for the sliding fee discount program for individuals who are at or below the 200% Federal Poverty Level Income guideline, in compliance with FQHC regulations. Quality Improvement conducts quality monitoring, reviews performance data, identifies areas of improvement, monitors performance efforts, implements policies and procedures, and develops and provides staff training. In addition, the quality improvement team develops and implements standards for workflows and medical record documentation into the Electronic Medical Record (EMR) system and provides information technology support/maintenance of the EMR and database functions necessary to

meet standards of practice and regulatory quality improvement programs required by federal, State, and local agencies. The Customer Service Center is the first point of contact for Clinic Services patients, and is responsible for scheduling appointments, answering patients' questions, and documenting information requests. The Center provides dedicated customer-focused services to all clinics and their customers.

Recommended FY 2023-24 Positions

Classification Code	Classification Label	FTE
12E04	BUREAU CHIEF	1.00
14C30	MANAGEMENT ANALYST II	2.00
14C31	MANAGEMENT ANALYST III	3.00
14G02	MANAGEMENT ANALYST I	2.00
14H66	OUTPATIENT SERVICES DIRECTOR	1.00
14K44	ASSISTANT BUREAU CHIEF	1.00
20B11	ACCOUNTANT II	2.00
20B12	ACCOUNTANT III	1.00

Recommended FY 2023-24 Positions

Classification Code	Classification Label	FTE
20B93	FINANCE MANAGER II	1.00
43J04	DEPARTMENTAL INFORMATION SYSTEMS SPECIALIST	1.00
43J05	DEPARTMENTAL INFORMATION SYSTEMS COORDINATOR	1.00
50K19	HEALTH EDUCATION ASSISTANT	8.00
50U42	MEDICAL ASSISTANT	3.00
52A83	SUPERVISING CLINIC NURSE	1.00
54B13	CLINIC SERVICES MEDICAL DIRECTOR	1.00
80A32	SENIOR SECRETARY	1.00
80E22	OFFICE ASSISTANT III	2.00
80J22	SENIOR ACCOUNT CLERK	1.00
80J30	ACCOUNTING TECHNICIAN	2.00
80L02	PATIENT SERVICES REPRESENTATIVE II	15.00
80L04	SUPERVISING PATIENT SERVICES REPRESENTATIVE	1.00
80M02	PATIENT FINANCIAL SERVICES SPECIALIST II	12.00
80M03	SENIOR PATIENT FINANCIAL SERVICES SPECIALIST	1.00
80M04	SUPERVISING PATIENT FINANCIAL SERVICES SPECIALIST	1.00
	Total	65.00

FQHC Clinics

(Budget Unit 8592—Fund 001—Appropriation Unit HEA007)

Use of Funds

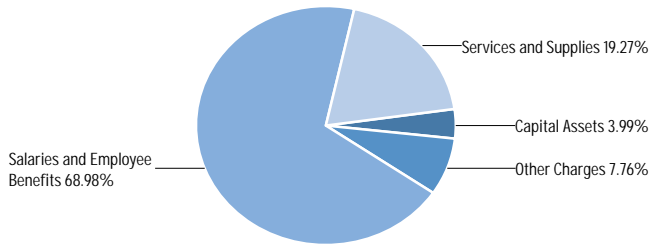

Source of Funds

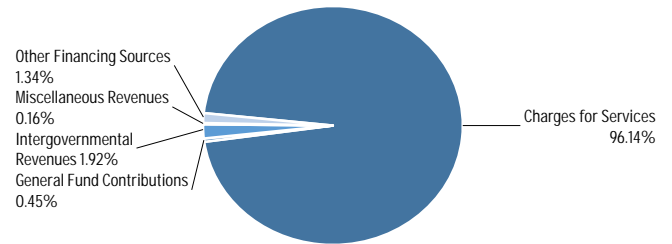

Use of Funds

Expenditures	Prior Year 2021-2022	Adopted Budget 2022-2023	CY Estimate 2022-2023	Requested Budget 2023-2024	Recommended Budget 2023-2024	Recommended Change from Adopted
Salaries and Employee Benefits	—	—	—	\$32,218,976	\$32,218,976	\$32,218,976
Services and Supplies	—	—	—	\$8,999,659	\$8,999,659	\$8,999,659
Other Charges	—	—	—	\$3,626,642	\$3,626,642	\$3,626,642
Capital Assets	—	—	—	\$1,862,959	\$1,862,959	\$1,862,959
Subtotal	—	—	—	\$46,708,236	\$46,708,236	\$46,708,236

Source of Funds

Revenues	Prior Year 2021-2022	Adopted Budget 2022-2023	CY Estimate 2022-2023	Requested Budget 2023-2024	Recommended Budget 2023-2024	Recommended Change from Adopted
Revenue from Use of Money & Property	—	—	—	\$15,490	\$15,490	\$15,490
Intergovernmental Revenues	—	—	—	\$894,630	\$894,630	\$894,630
Charges for Services	—	—	—	\$44,889,945	\$44,889,945	\$44,889,945
Miscellaneous Revenues	—	—	—	\$75,000	\$75,000	\$75,000
Other Financing Sources	—	—	—	\$623,895	\$623,895	\$623,895
Subtotal	—	—	—	\$46,498,960	\$46,498,960	\$46,498,960
Restricted Fund Balance	—	—	—	\$5,271,839	\$5,271,839	\$5,271,839
General Fund Contributions	—	—	—	\$(5,062,563)	\$(5,062,563)	\$(5,062,563)
Total Source of Funds	—	—	—	\$46,708,236	\$46,708,236	\$46,708,236

Unit Description

The Federally Qualified Health Centers (FQHC) Unit encompasses all the county-operated clinics. The Alisal Health Center, Laurel Family Practice, Laurel Internal Medicine, Laurel Pediatrics, Laurel Vista, and NIDO clinics are located in Salinas and provide primary and preventive care, obstetric and gynecological care and procedures, behavioral health, internal medicine, comprehensive perinatal and postpartum education, and pediatric primary and preventive care, and mental health services. Additionally, the Laurel Family Practice and Laurel Pediatrics clinics also serve as collaborative training sites for 30 Natividad family practice residents, and the NIDO clinic specializes in serving adults with a compromised immune system and

other infectious diseases such as HIV/AIDS, tuberculosis, and sexually transmitted infections and more. The Marina Health Center is in Marina, and it offers primary care and preventive services. The Seaside Family Health Center is located in Seaside and serves the Monterey Peninsula providing comprehensive primary care, preventative health services, including obstetric and gynecological care, pediatrics, mental health, and internal medicine. The Clinic offers services in a group visit setting for diabetic management and offers behavioral health services to those with mild to moderate mental health conditions. The Bienestar Clinic in Salinas and the Marina Integrated Clinic in Marina are operated in partnership with the Behavioral Health and provide primary care services to individuals with severe mental illness.

Recommended FY 2023-24 Positions

Classification Code	Classification Label	FTE
14N10	OUTPATIENT SERVICES MANAGER I	4.00
14N11	OUTPATIENT SERVICES MANAGER II	4.00
43J04	DEPARTMENTAL INFORMATION SYSTEMS SPECIALIST	5.00
50K19	HEALTH EDUCATION ASSISTANT	5.00
50U42	MEDICAL ASSISTANT	149.00
52A21	CLINIC NURSE	1.00
52A22	SENIOR CLINIC NURSE	9.00
52A97	CLINIC NURSE PRACTITIONER	8.00
54B04	GENERAL INTERNIST	2.00
54B12	CONTRACT PHYSICIAN	27.00
54B90	CLINIC PHYSICIAN II	4.00

Recommended FY 2023-24 Positions

Classification Code	Classification Label	FTE
54C03	CLINIC PHYSICIAN ASSISTANT	9.00
54C05	PSYCHIATRIC PHYSICIAN ASSISTANT	1.00
60B21	PSYCHIATRIC SOCIAL WORKER II	4.00
60B25	SENIOR PSYCHIATRIC SOCIAL WORKER	1.00
60C22	SOCIAL WORKER III	4.00
80K25	CLINIC OPERATIONS SUPERVISOR	8.00
80L02	PATIENT SERVICES REPRESENTATIVE II	44.00
80L04	SUPERVISING PATIENT SERVICES REPRESENTATIVE	1.00
	Total	290.00

Social Services

Departmental Overview:

The Department of Social Services (DSS) promotes the social and economic self-reliance of individuals and families in Monterey County through employment services, temporary financial assistance, social support services, protective services to children, dependent adults and seniors, and partnerships with the community to develop and support personal responsibility and self-sufficiency.

Programs and Functions:

COMMUNITY BENEFITS (CB) provides eligibility services for Medi-Cal health insurance, CalFresh nutrition assistance, CalWORKs through cash aid to families with children, and General Assistance to indigent adults.

FAMILY AND CHILDREN SERVICES BENEFITS (FCS) provides child abuse and neglect prevention, assesses and investigates referrals of child abuse and neglect, supports adoptions and other permanency resources when reunification is not possible, and provides independent living skills services for older youth who are in care or emancipating to independence.

CalWORKs EMPLOYMENT SERVICES administers the Welfare-to-Work Employment Program providing self-sufficiency services to CalWORKs customers. This includes childcare, job search support, skill building, wage subsidies, and services to overcome barriers related to housing, mental health, substance abuse, and domestic violence.

AGING AND ADULT SERVICES administers the Adult Protective Services (APS) Program to address abuse and dependent adult exploitation, In-Home Supportive Services (IHSS) program to provide home care services as an alternative to out of home residential or institutional care, Supplemental Security Income (SSI) advocacy to support disabled General Assistance recipients applying for more appropriate SSI benefits, and Area Agency on Aging programs for seniors.

MILITARY & VETERANS' AFFAIRS OFFICE (MVAO) provides support and assistance to veterans, their survivors, and dependents through outreach, preparation of benefit claims, and transportation to the San Jose and Palo Alto Veterans Affairs (VA) healthcare facilities.

Department's Contribution to Monterey County's Strategic Initiatives:

HEALTH AND HUMAN SERVICES:

Improve health and quality of life through promoting access to equitable opportunities for healthy choices and healthy environments in collaboration with communities through a strong network to support Medi-Cal, CalFresh and CalWORKs outreach, CalWORKs Employment, Child Welfare, Adult Protective Services, Behavioral Health and Community organizations.

ECONOMIC DEVELOPMENT INITIATIVE:

Strengthen economic development through the CalWORKs wage subsidy program that assists families in accessing long-term employment by underwriting wages while job skills are developed, delivering CalFresh nutrition assistance, allowing families to spend approximately \$68 million in federal funds at local groceries stores and restaurants, and determining eligibility for Medi-Cal benefits which are critical for sustaining the County's health care delivery system.



FOOD ASSISTANCE



ELDER CARE



SAFETY NET SERVICES



HEALTH INSURANCE



WELFARE TO WORK



CHILD WELFARE

Operating Budget: \$332,900,923
Positions (FTEs): 925.00

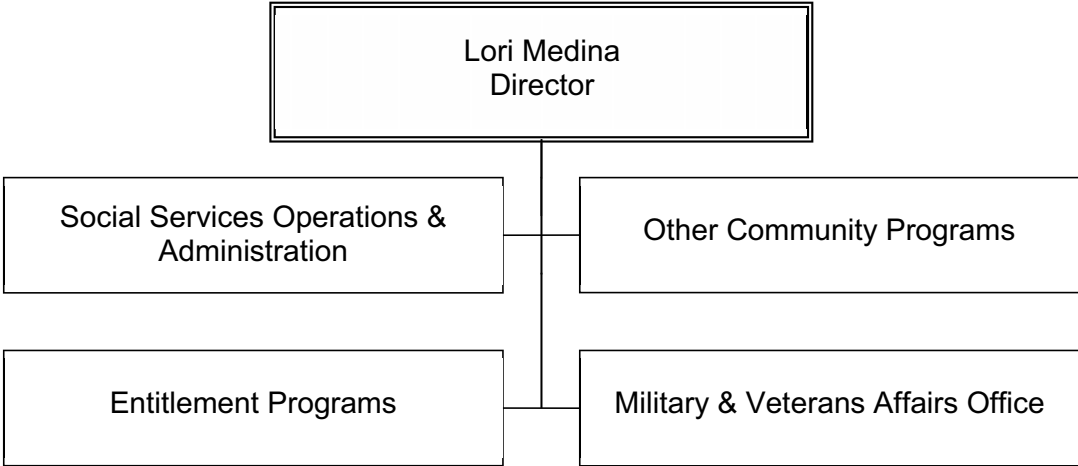

Staffing Trends

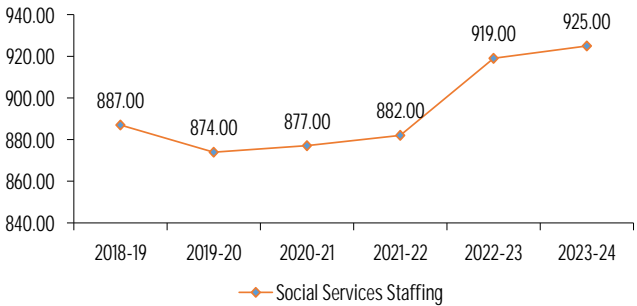

Expenditure/Revenue History (in millions)

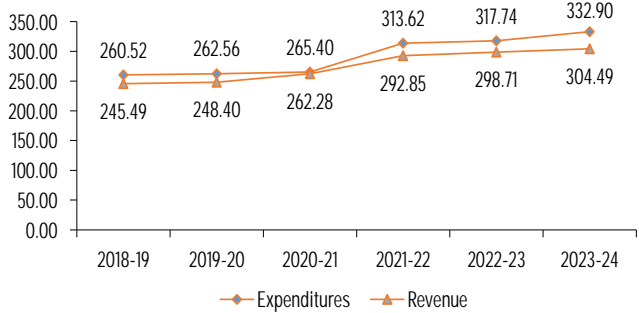

The following effectiveness measures demonstrate the Department’s efforts and performance in improving the social and economic security of county residents and assisting veterans and their families.

Key Performance Measures	2020-21 Actual	2021-22 Actual	2022-23 Mid-Year
Total county residents aided.	236,255	237,754	246,624
Percent of Community Benefits applications processed timely. Target = 100%	88.23%	88.93%	88.16%
Rate of work participation for CalWORKs (not including WINS). Target = 50%	62.93%	65.3%	56.0%
Average monthly number of IHSS recipients.	5,352	5,478	5,720
Number of adult protective services referrals	2,037	2,527	1,512
Number of child maltreatment allegations referred.	4,119	4,439	2,743
Children in care per 1,000 children in population.	3.1	2.8	2.1
Number of Veteran claims submitted.	4,084	3,595	3,574

Use of Funds

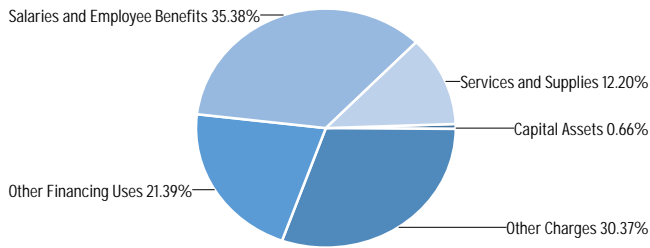

Source of Funds

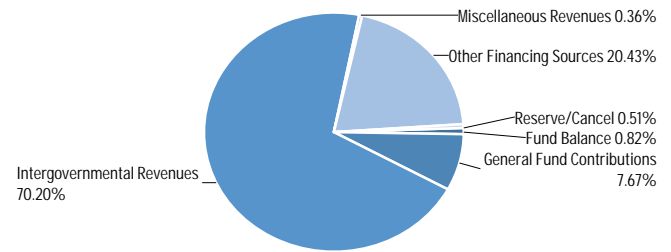

Use of Funds

Expenditures	Prior Year 2021-2022	Adopted Budget 2022-2023	CY Estimate 2022-2023	Requested Budget 2023-2024	Recommended Budget 2023-2024	Recommended Change from Adopted
Salaries and Employee Benefits	\$92,349,301	\$112,982,937	\$102,716,171	\$117,806,689	\$117,784,371	\$4,801,434
Services and Supplies	\$67,570,221	\$38,479,938	\$46,636,144	\$40,611,053	\$40,611,053	\$2,131,115
Other Charges	\$83,576,743	\$93,126,795	\$97,299,086	\$101,203,534	\$101,101,414	\$7,974,619
Capital Assets	\$1,950,998	\$525,000	\$2,516,693	\$2,212,529	\$2,212,529	\$1,687,529
Other Financing Uses	\$68,171,239	\$68,422,151	\$68,568,516	\$71,191,556	\$71,191,556	\$2,769,405
Subtotal	\$313,618,502	\$313,536,821	\$317,736,610	\$333,025,361	\$332,900,923	\$19,364,102

Source of Funds

Revenues	Prior Year 2021-2022	Adopted Budget 2022-2023	CY Estimate 2022-2023	Requested Budget 2023-2024	Recommended Budget 2023-2024	Recommended Change from Adopted
Revenue from Use of Money & Property	\$(2,698)	\$434	\$1,117	\$500	\$500	\$66
Intergovernmental Revenues	\$227,594,523	\$217,132,521	\$221,505,511	\$234,831,071	\$234,831,071	\$17,698,550
Charges for Services	\$112,000	\$120,000	\$117,000	\$115,000	\$115,000	\$(5,000)
Miscellaneous Revenues	\$203,759	\$4,092,225	\$10,734,180	\$1,210,985	\$1,210,985	\$(2,881,240)
Other Financing Sources	\$64,946,786	\$66,465,137	\$66,350,211	\$68,330,884	\$68,330,884	\$1,865,747
Subtotal	\$292,854,370	\$287,810,317	\$298,708,019	\$304,488,440	\$304,488,440	\$16,678,123
Other Funds - Fund Balance	\$(6,872,208)	—	\$(6,207,464)	\$2,745,224	\$2,745,224	\$2,745,224
General Fund Contributions	\$27,636,340	\$25,726,504	\$25,236,055	\$24,070,713	\$23,946,275	\$(1,780,229)
General Fund - Restricted Fund Balance	—	—	—	\$1,720,984	\$1,720,984	\$1,720,984
Total Source of Funds	\$313,618,502	\$313,536,821	\$317,736,610	\$333,025,361	\$332,900,923	\$19,364,102

Summary of Recommendation

The Recommended Budget for the Department of Social Services (DSS) totals \$332,900,923 in appropriations, financed by \$304,488,440 in program revenues, \$23,946,275 in General Fund Contributions (GFC), \$1,720,984 in general fund restricted assignment use (\$336,131 for Military & Veteran Services, and \$1,384,853 for Community Programs), and \$2,745,224 in departmental fund balance (\$1,728,635 of 1991 Realignment and \$1,016,589 of 2011 Realignment). This represents increased appropriations of \$19.4 million and increased estimated revenues of \$16.7 million from the Fiscal Year (FY) 2022-23 Adopted Budget. Significant increased costs are in the entitlement (client benefit) programs of \$7.1 million for CalWORKs due to caseload and monthly grant increases, \$1.6 million for In-Home Supportive Services (IHSS) mostly for the Maintenance of Effort (MOE) and negotiated wage increases, and \$2.0 million in Out of Home Care due to higher, more complex care placements and annual foster care increases. Additional increases include: \$4.8 million in Salaries and

Benefits to due various wage compensation studies, CalPERS retirement costs, and health insurance premiums; \$2.1 million in Services and Supplies which is attributable to increased Social Services contracts to provide services to Family & Children's Services (FCS) customers; \$2.8 million in operating transfers out due for 1991 and 2011 Sales Tax Realignment for entitlements which are offset by a decrease in obligations of \$0.9 million in the Community Programs various homeless programs such as Project Roomkey.

The Recommended Budget restores two positions, a Veteran's Representative III and a Management Analyst I for Military & Veteran's Affairs and adds six new positions, a Community Affiliations Manager for Area Agency on Aging, a Program Manager II for FCS, and four positions in Administration (Management Analyst III, Accounting Technician, and two Departmental Information Systems Coordinators). The Recommended Budget includes 925 full-time positions, representing an increase of six positions from the FY 2022-23 Adopted Budget.

Budget Impacts

The Recommended Budget does not include one augmentation of \$102,120 for General Assistance (GA) Program requesting a \$37 increase to the GA grant for a total of \$377 per month, similar to increases to the CalWORKs grant. The amount of assistance individuals are eligible to receive has remained unchanged since July 2017. It is currently set at a maximum of \$340 per month. Since that time, the cost of living has gone up significantly. By comparison, grants for families eligible for CalWORKs have increased by 11% since July 2017. It is estimated that 230 people per month will be aided through General Assistance.

Prior Year Accomplishments

In FY 2022-23, the Lead Me Home 5-Year Plan to Reduce Homelessness continued to serve as an essential element in the community for prioritizing goals, galvanizing collaboration, and increasing the community's competitive edge for applying and receiving new funding opportunities dedicated to addressing homelessness by securing and leveraging community resources and services. Collaboratively, it has facilitated successful efforts to connect service providers with grants to expand/sustain services and strategizing with the Health Department Mental Health Services Act (MHSA) grant opportunities to improve community coordination with the Housing Authority.

Collaborative efforts across County departments, jurisdictions, and community partners have targeted systems gaps and resulted in services that improve access to and linkages between services that lead to self-sufficiency. Parallel agreements have led to new services including street outreach and case management, expansion of navigation services, permanent supportive housing services, homeless prevention and housing stability services, and targeted rapid rehousing services for youth. DSS resources combined with staff committee work contributed to the development of community-wide shelter and outreach standards, community-wide rapid re-housing education and coordination, and investments in the improvement of the coordinated entry system.

Completed the Child and Family Team Meeting Program Directive that covers all FCS programs, the Emergency Response Policy and Procedure Manual, updated the Post Adoption Policy and Procedure and instituted post adoption tracking system to meet the needs of 849 post adoptive families.

Started referral of families from the programs of Emergency Response and Family Reunification to Connect, which is an evidence-based program that teaches parenting skills based on attachment theory. Social Workers are meeting with the biological family in their home for first visit of Family Reunification cases to address issues/barriers to working with the foster care system.

MVAO tirelessly advocated for the Central Coast's Veterans, active-duty servicemembers and their families to receive the healthcare and financial benefits of having an operational pharmacy at the Major General William H. Gourley Veteran's Affairs (VA)-Department of Defense (DoD) Outpatient Clinic in Marina. The office made presentations to Veteran-serving community organizations, local, State, and Federal elected officials, and VA Leadership on the importance of restoring pharmacy services at the Clinic.

MVAO worked closely with the County of Monterey Legislative Committee to prioritize introduction of legislation to study or develop a CalVet Veterans Home on the Central Coast. MVAO participated in several media briefs and a well-attended press event that included local, State, and Federal leaders. MVAO met with California State Assembly members, Senate officials and CalVet leadership to

highlight the need of elderly, homeless, and at-risk Veterans and their spouses.

Applied for and received the Home Safe grant to provide wrap around services for seniors at risk of homelessness and an intergenerational grant to implement intergenerational activities that connect seniors with younger generations to strengthen older adult's recovery and resilience from the severe isolation and health impacts of staying at home due to the COVID-19 pandemic.

Designated as a Monterey County Aging and Disability Resource Connection (ADRC) County to expand No Wrong Door service delivery model.

Provided cross training opportunities to CalWORKs Employment Services (CWES) and Aging and Adult Services (AAS) staff and co-located the MVOA office at the One Stop Community Center. Community Benefits sustained high levels of customer responsiveness and accuracy in processing applications over 90% for all programs. In addition, the emergency and regular processing of CalFresh has averaged over 98%. Monterey County has been acknowledged by California Department of Social Services (CDSS) for its processing rates for CalFresh emergency and regular applications for being well above the State average, while having significant caseload growth. The accuracy rate for the CalFresh program exceeded 93%.

Community Benefits continued to expanded services, in CalWORKs, CalFresh, and Medi-Cal with the overall caseload growing by almost 16,000 cases and the individuals served by 30,000. Community Benefits continued to expand pathways to apply for benefits during this period to ensure ease of access which included 31 presentations within Monterey County, to provide program and enrollment information, as well as support to existing customers which encompassed almost 16,000 individuals.

During this period Community Benefits grew the number of Community Based Organization (CBO's) from 28 to 100. This is a direct support to Monterey County residents in accessing and applying for benefits.

Budget Year Goals

Develop and expand partnerships with County departments and community partners to strengthen and sustain system-wide infrastructure aimed at addressing homelessness.

Develop funding strategies, including interdepartmental MOUs and joint funding plans with partners in anticipation of federal and state changes in policy and funding priorities.

Ensure policy and procedures are developed, staff trained, and implemented for all FCS programs.

Grow the organization by moving toward a more streamlined recruitment and hiring process and through retention efforts with current staff and recruitment through partnering with schools of social work to help them understand what is needed to produce competent graduates for the field of child welfare.

Encourage and work with staff from all County departments with an interest in social work to gain the experience and education to work for FCS.

Continue the effort to establish a pharmacy at the Major General William H. Gourley VA- DoD Outpatient Clinic. Continue the effort to introduce legislation to establish a California Department of Veterans Affairs - Veterans Home in Monterey County.

Pilot and implement the Home Safe Program to provide wrap around services for seniors at risk of homelessness.

Apply for the Age Wise Program and, if granted, pilot and implement the program to help meet the mental health needs of some of the most vulnerable and at-risk seniors.

Continue to expand the ADRC No Wrong Door service delivery model.

Continue to expand the creation of a seamless and welcoming service delivery model to meet the needs of AAS and CWES families with children, elders, and individuals with disabilities that maximizes CWES and AAS resources.

Re-establish in-person Job Search Workshops for CWES Customers to assist them in developing soft skills to better prepare them for employment opportunities.

Community Benefits will continue to sustain high service delivery levels, through the delivery of timely benefits in all programs.

Community Benefits will continue to expand efforts in outreach for Monterey County residents to apply for CalWORKs, CalFresh, and Medi-Cal as the access broadens for the hardest to reach remote areas of Monterey County by obtaining a mobile-hotspot vehicle with the ability to apply for benefits onsite at any location, including rural areas that lack Wi-Fi, remote disaster shelters, and rural disaster areas within Monterey County.

Pending Issues

Monterey County's Project Roomkey, in partnership with the City of Salinas, ends June 20, 2023. The City of Salinas is transitioning from Marina, serving those with COVID-19 risk factors, to a new model in Salinas called the Emergency Motel Room Program that will provide ongoing housing navigation support as an access point to attain permanent housing and more fully utilize Emergency Housing vouchers in Monterey County. This new model will cost approximately \$4.3 million for one year and the City of Salinas has a funding gap of \$1.4 million. The Department is seeking support for \$543,664 of estimated unused one-time FY 2022-23 DSS approved ARPA funding for Project Roomkey be rolled over to FY 2023-24 to partner with City of Salinas on their Emergency Motel Room Program so that their program will serve all Monterey County.

Community Human Services (CHS) is scheduled to open a new shelter July 2023 on the Monterey Peninsula called Shuman Hearthouse. This shelter will provide 35 shelter beds for women and families with children and provide comprehensive supportive services, life skills education, and youth academic support. The annual operating budget is estimated at \$794,250 and CHS is seeking ongoing support of \$100,000 for this new shelter.

Policy Considerations

See Budget Impacts.

Appropriation Expenditure Detail

	Prior Year 2021-2022	Adopted Budget 2022-2023	CY Estimate 2022-2023	Requested Budget 2023-2024	Recommended Budget 2023-2024	Recommended Change from Adopted	Fund Code	Budget Unit Code
CalWORKS/TANF (SOC001)	28,550,720	29,558,305	31,951,324	36,676,064	36,676,064	7,117,759	001	8252
General Assistance (SOC002)	496,077	1,064,495	894,564	881,475	779,355	(285,140)	001	8253
IHSS Wages/Benefits (SOC001)	20,689,430	23,885,855	23,885,854	25,499,426	25,499,426	1,613,571	001	8254
Out of Home Care (SOC001)	21,386,069	24,474,804	26,226,527	26,455,603	26,455,603	1,980,799	001	8255
Community Action Partnership (SOC007)	898,913	519,881	535,857	503,733	503,733	(16,148)	008	8257
Community Programs (SOC004)	38,406,950	6,260,081	12,723,047	4,666,606	4,666,606	(1,593,475)	001	8258
IHSS Public Authority (SOC008)	817,124	1,018,734	958,749	1,019,853	1,019,853	1,119	005	8259
Military & Veterans Services (SOC003)	2,427,387	2,175,989	2,138,888	2,378,240	2,355,922	179,933	001	8260
Social Services (SOC005)	128,750,096	152,978,766	144,876,248	157,993,784	157,993,784	5,015,018	001	8262
Area Agency on Aging (SOC010)	3,810,893	3,348,151	5,147,866	5,931,509	5,931,509	2,583,358	001	8268
Social Services Realignment (SOC012)	45,902,168	43,831,625	43,061,931	45,539,894	45,539,894	1,708,269	025	8425
Protective Services (SOC011)	21,482,676	24,420,135	25,335,755	25,479,174	25,479,174	1,059,039	022	8464
Subtotal	\$313,618,502	\$313,536,821	\$317,736,610	\$333,025,361	\$332,900,923	\$19,364,102		

Budget Units

	Prior Year 2021-2022	Adopted Budget 2022-2023	CY Estimate 2022-2023	Requested Budget 2023-2024	Recommended Budget 2023-2024	Recommended Change from Adopted
CalWORKS/TANF	\$28,550,720	\$29,558,305	\$31,951,324	\$36,676,064	\$36,676,064	\$7,117,759
General Assistance	\$496,077	\$1,064,495	\$894,564	\$881,475	\$779,355	\$(285,140)
IHSS Wages/Benefits	\$20,689,430	\$23,885,855	\$23,885,854	\$25,499,426	\$25,499,426	\$1,613,571
Out of Home Care	\$21,386,069	\$24,474,804	\$26,226,527	\$26,455,603	\$26,455,603	\$1,980,799
Community Action Partnership	\$898,913	\$519,881	\$535,857	\$503,733	\$503,733	\$(16,148)
Community Programs	\$38,406,950	\$6,260,081	\$12,723,047	\$4,666,606	\$4,666,606	\$(1,593,475)

Budget Units

	Prior Year 2021-2022	Adopted Budget 2022-2023	CY Estimate 2022-2023	Requested Budget 2023-2024	Recommended Budget 2023-2024	Recommended Change from Adopted
IHSS Public Authority	\$817,124	\$1,018,734	\$958,749	\$1,019,853	\$1,019,853	\$1,119
Military & Veterans Services	\$2,427,387	\$2,175,989	\$2,138,888	\$2,378,240	\$2,355,922	\$179,933
Social Services	\$128,750,096	\$152,978,766	\$144,876,248	\$157,993,784	\$157,993,784	\$5,015,018
Area Agency on Aging	\$3,810,893	\$3,348,151	\$5,147,866	\$5,931,509	\$5,931,509	\$2,583,358
Social Services Realignment	\$45,902,168	\$43,831,625	\$43,061,931	\$45,539,894	\$45,539,894	\$1,708,269
Protective Services	\$21,482,676	\$24,420,135	\$25,335,755	\$25,479,174	\$25,479,174	\$1,059,039
Subtotal	\$313,618,502	\$313,536,821	\$317,736,610	\$333,025,361	\$332,900,923	\$19,364,102

Adopted FY 2022-23 to Recommended FY 2023-24 Positions

Classification Code	Classification Label	Adopted Budget 2021-2022	Adopted Budget 2022-2023	Recommended Budget 2023-2024	Change
11A12	DIRECTOR OF SOCIAL SERVICES	1.00	1.00	1.00	0.00
12C13	ASSISTANT DIRECTOR SOCIAL SERVICES	1.00	1.00	1.00	0.00
14B21	ASSOCIATE PERSONNEL ANALYST	4.00	4.00	4.00	0.00
14B32	SENIOR PERSONNEL ANALYST	1.00	2.00	2.00	0.00
14B51	DEPARTMENTAL HR MANAGER-MERIT SYSTEMS	1.00	1.00	1.00	0.00
14C30	MANAGEMENT ANALYST II	18.00	20.00	20.00	0.00
14C31	MANAGEMENT ANALYST III	15.00	16.00	17.00	1.00
14C70	ADMINISTRATIVE SERVICES ASSISTANT	8.00	8.00	8.00	0.00
14C72	ADMINISTRATIVE SERVICES MANAGER	1.00	1.00	1.00	0.00
14G02	MANAGEMENT ANALYST I	1.00	1.00	1.00	0.00
14H03	PERSONNEL TECHNICIAN-CONFIDENTIAL	4.00	5.00	5.00	0.00
14H70	STAFF TRAINER II	12.00	12.00	12.00	0.00
14N05	ADMINISTRATIVE OPERATIONS MANAGER	1.00	1.00	1.00	0.00
16C87	BUSINESS TECHNOLOGY ANALYST II	5.00	5.00	5.00	0.00
16C88	BUSINESS TECHNOLOGY ANALYST III	1.00	1.00	2.00	1.00
16C93	BUSINESS TECHNOLOGY ANALYST IV	1.00	2.00	2.00	0.00
16F40	DEPARTMENTAL INFORMATION SYSTEMS MANAGER I	1.00	1.00	1.00	0.00
16F41	DEPARTMENTAL INFORMATION SYSTEMS MANAGER II	1.00	1.00	1.00	0.00
20B10	ACCOUNTANT I	2.00	3.00	3.00	0.00
20B11	ACCOUNTANT II	4.00	5.00	5.00	0.00
20B12	ACCOUNTANT III	1.00	1.00	1.00	0.00
20B93	FINANCE MANAGER II	2.00	2.00	2.00	0.00
20B94	FINANCE MANAGER III	1.00	1.00	1.00	0.00
20B95	FINANCE MANAGER I	0.00	0.00	1.00	1.00
25E21	ELIGIBILITY SPECIALIST II	168.00	182.00	182.00	0.00
25E22	ELIGIBILITY SPECIALIST III	107.00	111.00	111.00	0.00
25E80	ELIGIBILITY SUPERVISOR	38.00	40.00	40.00	0.00
43J05	DEPARTMENTAL INFORMATION SYSTEMS COORDINATOR	3.00	3.00	5.00	2.00
43J09	SENIOR DEPARTMENTAL INFORMATION SYSTEMS COORDINATOR	6.00	6.00	6.00	0.00
43J15	SUPERVISING DEPARTMENTAL INFORMATION SYSTEMS COORDINATOR	2.00	2.00	2.00	0.00
52E22	PUBLIC HEALTH NURSE II	3.00	3.00	2.00	(1.00)
60C22	SOCIAL WORKER III	40.00	40.00	40.00	0.00
60C24	SOCIAL WORKER V	81.00	92.00	92.00	0.00
60C80	SOCIAL WORK SUPERVISOR I	8.00	8.00	8.00	0.00
60C81	SOCIAL WORK SUPERVISOR II	17.00	19.00	19.00	0.00
60D10	SOCIAL SERVICES AIDE I	2.00	2.00	2.00	0.00
60D11	SOCIAL SERVICES AIDE II	66.00	66.00	66.00	0.00

Adopted FY 2022-23 to Recommended FY 2023-24 Positions

Classification Code	Classification Label	Adopted Budget 2021-2022	Adopted Budget 2022-2023	Recommended Budget 2023-2024	Change
60H11	EMPLOYMENT & TRAINING WORKER II	2.00	1.00	1.00	0.00
60H21	EMPLOYMENT & TRAINING WORKER III	33.00	32.00	32.00	0.00
60H31	EMPLOYMENT & TRAINING SUPERVISOR	7.00	7.00	7.00	0.00
60H32	SUPERVISING STAFF TRAINER	1.00	1.00	1.00	0.00
60I01	DEPUTY DIRECTOR SOCIAL SERVICES	4.00	4.00	4.00	0.00
60I02	PROGRAM MANAGER II	14.00	14.00	15.00	1.00
60U11	MILITARY & VETERANS REPRESENTATIVE II	2.00	2.00	2.00	0.00
60U20	MILITARY & VETERAN AFFAIRS OFFICER	1.00	1.00	1.00	0.00
60U21	MILITARY & VETERANS REPRESENTATIVE III	4.00	4.00	4.00	0.00
60X01	COMMUNITY AFFILIATION MANAGER	1.00	1.00	2.00	1.00
70A21	CUSTODIAN	1.00	1.00	1.00	0.00
70F21	COURIER	1.00	1.00	1.00	0.00
70F23	STOREKEEPER	0.00	2.00	2.00	0.00
70F79	WAREHOUSE WORKER	2.00	0.00	0.00	0.00
70F81	SUPERVISING STOREKEEPER	0.00	1.00	1.00	0.00
70F82	SUPERVISING WAREHOUSE WORKER	1.00	0.00	0.00	0.00
70N01	OFFICE MAINTENANCE WORKER	2.00	3.00	3.00	0.00
80A31	SECRETARY	13.00	13.00	13.00	0.00
80A32	SENIOR SECRETARY	6.00	6.00	5.00	(1.00)
80A99	ADMINISTRATIVE SECRETARY-CONFIDENTIAL	1.00	1.00	1.00	0.00
80E21	OFFICE ASSISTANT II	82.00	81.00	81.00	0.00
80E22	OFFICE ASSISTANT III	36.00	36.00	36.00	0.00
80E80	PRINCIPAL OFFICE ASSISTANT	13.00	13.00	13.00	0.00
80E81	SUPERVISING OFFICE ASSISTANT I	17.00	17.00	17.00	0.00
80E82	SUPERVISING OFFICE ASSISTANT II	2.00	2.00	2.00	0.00
80E98	PRINCIPAL CLERK-CONFIDENTIAL	2.00	0.00	0.00	0.00
80J20	ACCOUNTING CLERICAL SUPERVISOR	1.00	1.00	1.00	0.00
80J22	SENIOR ACCOUNT CLERK	2.00	1.00	0.00	(1.00)
80J30	ACCOUNTING TECHNICIAN	3.00	4.00	6.00	2.00
Total		882.00	919.00	925.00	6.00

Social Services

Augmentation Requests

Request Code	Request Name	Ranking Type Name	Requested Amount	Requested FTE	Recommended Budget	Recommended FTE
5010-8253-001-AUG7	General Assistance	New Program/Service w/ General Fund Funding	102,120	-	-	-
5010-8254-001-AUG9	IHSS Wage/Health Benefits	Status Quo Other	1,316,047	-	1,316,047	-
5010-8258-001-AUG10	CHE Outreach	Status Quo Other	75,000	-	75,000	-
5010-8260-001-AUG11	Veteran's Representative III	Status Quo Vacant Position	133,906	1.00	111,588	1.00
5010-8260-001-AUG12	Management Analyst I	Status Quo Filled Position	130,735	1.00	130,735	1.00
5010-8262-001-AUG2	Program Manager II	Request New Position	-	1.00	-	1.00
5010-8262-001-AUG3	Dept Info Sys Coordinator	Request New Position	-	1.00	-	1.00
5010-8262-001-AUG4	Dept Info Sys Coordinator	Request New Position	-	1.00	-	1.00
5010-8262-001-AUG5	Accounting Technician	Request New Position	-	1.00	-	1.00
5010-8262-001-AUG6	Management Analyst III	Request New Position	-	1.00	-	1.00
5010-8268-001-AUG1	Community Affiliations Manager	Request New Position	-	1.00	-	1.00
5010-8464-022-AUG13	Operating Transfer Out	Request New Position	141,417	-	141,417	-
Grand Total:			\$1,899,225	8.00	\$1,774,787	8.00

CalWORKS/TANF

(Budget Unit 8252—Fund 001—Appropriation Unit SOC001)

Use of Funds

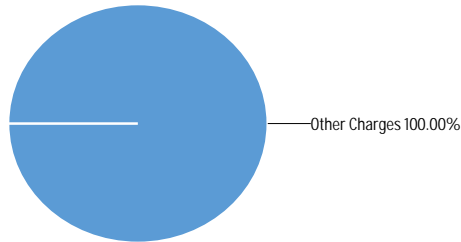

Source of Funds

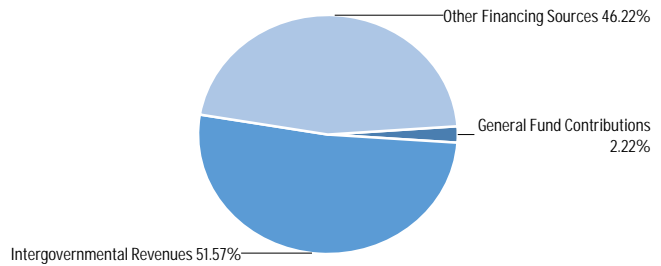

Use of Funds

Expenditures	Prior Year 2021-2022	Adopted Budget 2022-2023	CY Estimate 2022-2023	Requested Budget 2023-2024	Recommended Budget 2023-2024	Recommended Change from Adopted
Other Charges	\$28,550,720	\$29,558,305	\$31,951,324	\$36,676,064	\$36,676,064	\$7,117,759
Subtotal	\$28,550,720	\$29,558,305	\$31,951,324	\$36,676,064	\$36,676,064	\$7,117,759

Source of Funds

Revenues	Prior Year 2021-2022	Adopted Budget 2022-2023	CY Estimate 2022-2023	Requested Budget 2023-2024	Recommended Budget 2023-2024	Recommended Change from Adopted
Intergovernmental Revenues	\$6,256,614	\$12,040,308	\$13,004,390	\$18,913,153	\$18,913,153	\$6,872,845
Other Financing Sources	\$21,571,165	\$16,733,157	\$18,162,094	\$16,949,912	\$16,949,912	\$216,755
Subtotal	\$27,827,778	\$28,773,465	\$31,166,484	\$35,863,065	\$35,863,065	\$7,089,600
General Fund Contributions	\$722,941	\$784,840	\$784,840	\$812,999	\$812,999	\$28,159
Total Source of Funds	\$28,550,720	\$29,558,305	\$31,951,324	\$36,676,064	\$36,676,064	\$7,117,759

Unit Description

CalWORKs is California's implementation of the Federal Temporary Assistance for Needy Families (TANF) program. It is a temporary cash assistance program for very low-income families that have a child(ren) in the home. If the family has little or no cash and needs housing, food, utilities, clothing, or medical care, they may be eligible to receive immediate assistance. Families that apply and qualify for ongoing assistance receive money each month to help pay for housing, food, and other necessary expenses. Families can also apply and be screened for other support programs such as: CalFresh, and Medi-Cal.

The CalWORKs Welfare-to-Work Employment Services (CWES) Program provides employment focused services as well as supportive services to address the underlying social, educational, economic, health, mental health, and housing barriers to employment to assist families move toward self-sufficiency. Supportive services also include; childcare, transportation, books, clothing, job search and interviewing techniques, learning disability assessments, tutoring, credit repair, and behavior health counseling. In California, adult household members are eligible for a maximum of 60 months of cash aid and supportive services offered through the CWES program.

General Assistance

(Budget Unit 8253—Fund 001—Appropriation Unit SOC002)

Use of Funds

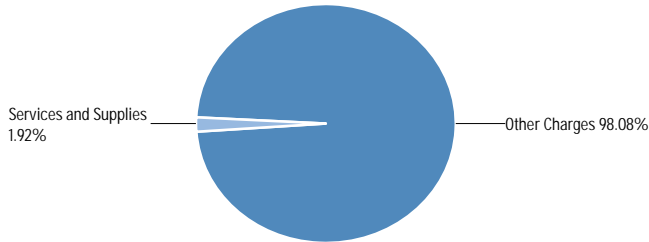

Source of Funds

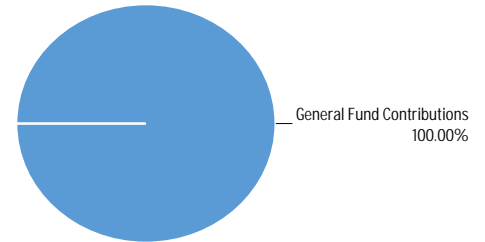

Use of Funds

Expenditures	Prior Year 2021-2022	Adopted Budget 2022-2023	CY Estimate 2022-2023	Requested Budget 2023-2024	Recommended Budget 2023-2024	Recommended Change from Adopted
Services and Supplies	\$11,398	\$9,000	\$15,000	\$15,000	\$15,000	\$6,000
Other Charges	\$484,679	\$1,055,495	\$879,564	\$866,475	\$764,355	\$(291,140)
Subtotal	\$496,077	\$1,064,495	\$894,564	\$881,475	\$779,355	\$(285,140)

Source of Funds

Revenues	Prior Year 2021-2022	Adopted Budget 2022-2023	CY Estimate 2022-2023	Requested Budget 2023-2024	Recommended Budget 2023-2024	Recommended Change from Adopted
General Fund Contributions	\$496,077	\$1,064,495	\$894,564	\$881,475	\$779,355	\$(285,140)
Total Source of Funds	\$496,077	\$1,064,495	\$894,564	\$881,475	\$779,355	\$(285,140)

Unit Description

General Assistance is a County-funded program that provides cash and "in-kind" assistance to indigent adults who are not eligible for other public assistance programs. There are two parts to this aid program: 1) Regular General Assistance payments for indigent adults who are able to work; and 2) Interim Assistance which is paid to indigent adults who are applying for Supplemental Security Income/

State Supplementary Program (SSI/SSP) because of a disability. Adults who are able to work are required to participate in the General Assistance Work Experience Program (GA-WEP) that secures work with government or non-profit agencies. Eligibility for the GA-WEP program is limited to 6 months of assistance in a twelve-month period.

IHSS Wages/Benefits

(Budget Unit 8254—Fund 001—Appropriation Unit SOC001)

Use of Funds

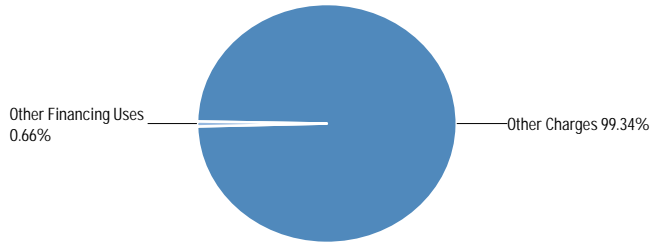

Source of Funds

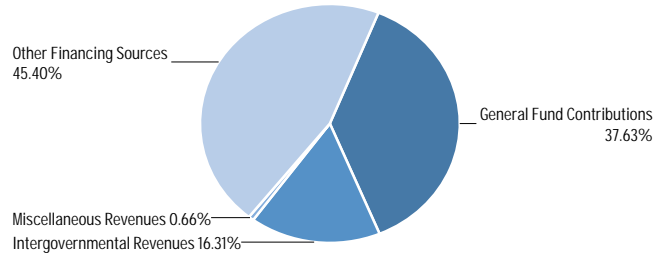

Use of Funds

Expenditures	Prior Year 2021-2022	Adopted Budget 2022-2023	CY Estimate 2022-2023	Requested Budget 2023-2024	Recommended Budget 2023-2024	Recommended Change from Adopted
Services and Supplies	—	—	—	\$10,000	\$10,000	\$10,000
Other Charges	\$20,623,151	\$23,718,864	\$23,718,864	\$25,320,896	\$25,320,896	\$1,602,032
Other Financing Uses	\$66,279	\$166,991	\$166,990	\$168,530	\$168,530	\$1,539
Subtotal	\$20,689,430	\$23,885,855	\$23,885,854	\$25,499,426	\$25,499,426	\$1,613,571

Source of Funds

Revenues	Prior Year 2021-2022	Adopted Budget 2022-2023	CY Estimate 2022-2023	Requested Budget 2023-2024	Recommended Budget 2023-2024	Recommended Change from Adopted
Intergovernmental Revenues	\$3,272,177	\$4,866,090	\$4,866,090	\$4,159,462	\$4,159,462	\$(706,628)
Miscellaneous Revenues	—	\$122,500	\$122,500	\$167,053	\$167,053	\$44,553
Other Financing Sources	\$10,078,966	\$10,904,351	\$10,904,350	\$11,577,174	\$11,577,174	\$672,823
Subtotal	\$13,351,143	\$15,892,941	\$15,892,940	\$15,903,689	\$15,903,689	\$10,748
General Fund Contributions	\$7,338,287	\$7,992,914	\$7,992,914	\$9,595,737	\$9,595,737	\$1,602,823
Total Source of Funds	\$20,689,430	\$23,885,855	\$23,885,854	\$25,499,426	\$25,499,426	\$1,613,571

Unit Description

In-Home Supportive Services (IHSS) provides for the cost of home care services to support the independence of aged, blind, and disabled persons and to help them live safely in their own homes and community. Services range from personal care, meal preparation, and housekeeping. Individuals can receive IHSS if they are eligible for SSI/SSP and/or Medi-Cal and live independently. The appropriations

are for the IHSS Maintenance of Effort (MOE), the total cost of health benefits, and an operating transfer from IHSS Public Authority county share of costs. The IHSS MOE represents the County's share of cost for the following: service provider wages, IHSS administrative costs, health benefits for caregivers, and the administration of the IHSS Public Authority.

Out of Home Care

(Budget Unit 8255—Fund 001—Appropriation Unit SOC001)

Use of Funds

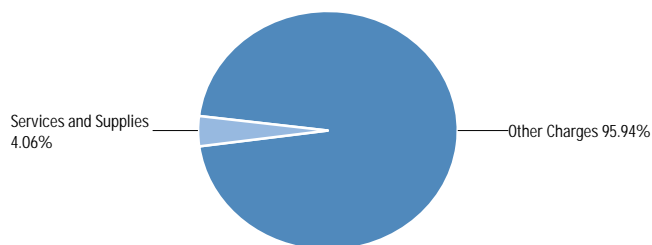

Source of Funds

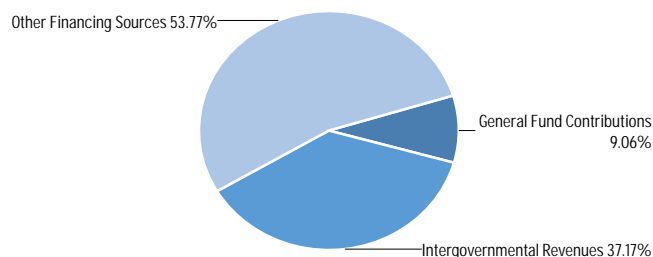

Use of Funds

Expenditures	Prior Year 2021-2022	Adopted Budget 2022-2023	CY Estimate 2022-2023	Requested Budget 2023-2024	Recommended Budget 2023-2024	Recommended Change from Adopted
Services and Supplies	\$472,504	\$542,818	\$502,033	\$1,073,261	\$1,073,261	\$530,443
Other Charges	\$20,913,565	\$23,931,986	\$25,724,494	\$25,382,342	\$25,382,342	\$1,450,356
Subtotal	\$21,386,069	\$24,474,804	\$26,226,527	\$26,455,603	\$26,455,603	\$1,980,799

Source of Funds

Revenues	Prior Year 2021-2022	Adopted Budget 2022-2023	CY Estimate 2022-2023	Requested Budget 2023-2024	Recommended Budget 2023-2024	Recommended Change from Adopted
Intergovernmental Revenues	\$9,941,586	\$8,967,537	\$9,038,736	\$9,833,987	\$9,833,987	\$866,450
Other Financing Sources	\$9,421,095	\$13,193,192	\$14,873,716	\$14,224,515	\$14,224,515	\$1,031,323
Subtotal	\$19,362,681	\$22,160,729	\$23,912,452	\$24,058,502	\$24,058,502	\$1,897,773
General Fund Contributions	\$2,023,388	\$2,314,075	\$2,314,075	\$2,397,101	\$2,397,101	\$83,026
Total Source of Funds	\$21,386,069	\$24,474,804	\$26,226,527	\$26,455,603	\$26,455,603	\$1,980,799

Unit Description

Appropriations in the Out of Home Care budget provide for living expenses of children who are placed out of home as a result of parental unwillingness or inability to provide care. This support includes payments for emergency placements, foster care, wraparound, assistance to adoptive families, and assistance for emancipated youth transitioning to independence and adulthood. These programs receive a statutory cost of living adjustment on July 1st of each year based on the California Necessities Index (CNI). Out of Home Care programs include:

- 1) Aid to Families with Dependent Children Foster Care (AFDC-FC) provides the cost of foster care for children under the jurisdiction of the juvenile court. Foster care aid payments are made on behalf of children placed in resource homes (formerly referred to as foster homes, relative or non-related extended family homes) or institutions by social workers as well as by probation officers. This category of placement is now called resource families rather than foster families.
- 2) The Adoption Assistance Program (AAP) supports the cost of care for families adopting children with special needs.
- 3) County Court Dependent Children provides the cost of foster care for children placed by court order that are not eligible under the AFDC-FC program.

4) Emergency Placements provide for the cost of care for children placed in emergency short-term foster homes while court jurisdiction is established.

5) The Wraparound Program funds comprehensive supportive social services to assist foster children with serious emotional challenges to live safely with families within the community in lieu of high cost residential treatment.

6) The Transitional Housing Placement Program (THPP) helps participants ages 16 through 20 to transition to adulthood successfully by providing a safe environment for youth to thrive and reach their potential. Within THPP, participating youth practice the skills learned in the Independent Living Program (ILP). Participants may live alone, with departmental approval, or with roommates in apartments and single-family dwellings with regular support and supervision provided by THPP agency staff, ILP Coordinators, and County Social Workers/Probation Officers

7) THP-Plus is a transitional housing placement opportunity for former foster youth, aged 18-24, who exited the foster care child welfare system after age eighteen with the goal to achieve self-sufficiency.

Community Action Partnership

(Budget Unit 8257—Fund 008—Appropriation Unit SOC007)

Use of Funds

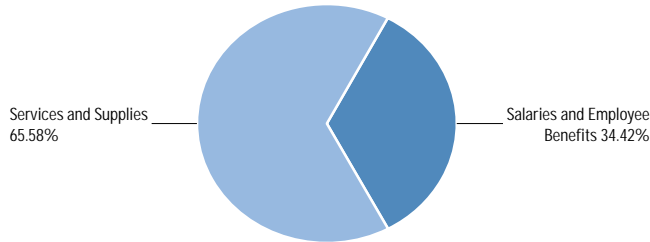

Source of Funds

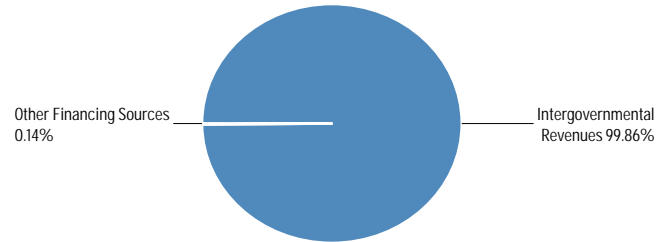

Use of Funds

Expenditures	Prior Year 2021-2022	Adopted Budget 2022-2023	CY Estimate 2022-2023	Requested Budget 2023-2024	Recommended Budget 2023-2024	Recommended Change from Adopted
Salaries and Employee Benefits	\$223,719	\$186,527	\$165,176	\$204,875	\$204,875	\$18,348
Services and Supplies	\$766,599	\$408,545	\$446,755	\$390,406	\$390,406	\$(18,139)
Other Charges	\$(91,406)	\$(75,191)	\$(76,074)	\$(91,548)	\$(91,548)	\$(16,357)
Subtotal	\$898,913	\$519,881	\$535,857	\$503,733	\$503,733	\$(16,148)

Source of Funds

Revenues	Prior Year 2021-2022	Adopted Budget 2022-2023	CY Estimate 2022-2023	Requested Budget 2023-2024	Recommended Budget 2023-2024	Recommended Change from Adopted
Revenue from Use of Money & Property	\$367	\$434	\$1,000	\$500	\$500	\$66
Intergovernmental Revenues	\$884,932	\$518,692	\$534,102	\$502,515	\$502,515	\$(16,177)
Other Financing Sources	\$954	\$755	\$755	\$718	\$718	\$(37)
Subtotal	\$886,253	\$519,881	\$535,857	\$503,733	\$503,733	\$(16,148)
Fund Balance	\$12,660	—	—	—	—	—
Total Source of Funds	\$898,913	\$519,881	\$535,857	\$503,733	\$503,733	\$(16,148)

Unit Description

The Monterey County Community Action Partnership (MCCAP) administers the federal Community Services Block Grant (CSBG). MCCAP contracts with non-profit community-based organizations to provide programs that advance and advocate for low-income and vulnerable populations and support services that help attain self-sufficiency. MCCAP combines CSBG-funded efforts with resources from restricted and general discretionary funds budgeted in Unit 8258 for homeless and emergency rental assistance programs and state funds in Unit 8262 for housing support to amplify the impact of limited federal resources. Priority program areas include safety-net

services such as: housing and shelter resources, food access, information and referrals, domestic violence prevention and intervention, youth and family counseling, youth engagement activities, youth employment support, and homeless planning and coordination.

Recommended FY 2023-24 Positions

Classification Code	Classification Label	FTE
60X01	COMMUNITY AFFILIATION MANAGER	1.00
Total		1.00

Community Programs

(Budget Unit 8258—Fund 001—Appropriation Unit SOC004)

Use of Funds

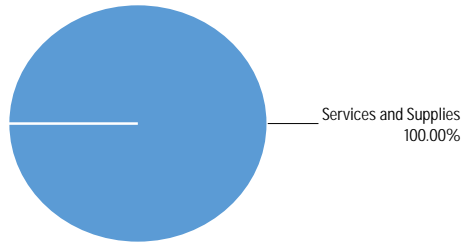

Source of Funds

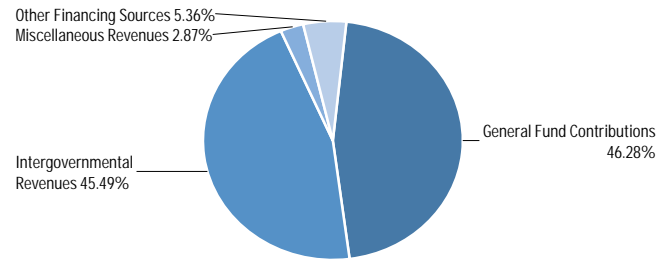

Use of Funds

Expenditures	Prior Year 2021-2022	Adopted Budget 2022-2023	CY Estimate 2022-2023	Requested Budget 2023-2024	Recommended Budget 2023-2024	Recommended Change from Adopted
Services and Supplies	\$38,711,196	\$6,256,681	\$12,560,610	\$4,662,648	\$4,662,648	\$(1,594,033)
Other Charges	\$(320,997)	—	—	—	—	—
Capital Assets	\$12,397	—	\$158,597	—	—	—
Other Financing Uses	\$4,354	\$3,400	\$3,840	\$3,958	\$3,958	\$558
Subtotal	\$38,406,950	\$6,260,081	\$12,723,047	\$4,666,606	\$4,666,606	\$(1,593,475)

Source of Funds

Revenues	Prior Year 2021-2022	Adopted Budget 2022-2023	CY Estimate 2022-2023	Requested Budget 2023-2024	Recommended Budget 2023-2024	Recommended Change from Adopted
Intergovernmental Revenues	\$34,187,571	—	—	\$2,123,039	\$2,123,039	\$2,123,039
Miscellaneous Revenues	\$132,950	\$3,423,940	\$10,335,911	\$133,932	\$133,932	\$(3,290,008)
Other Financing Sources	\$612,519	—	—	\$250,000	\$250,000	\$250,000
Subtotal	\$34,933,041	\$3,423,940	\$10,335,911	\$2,506,971	\$2,506,971	\$(916,969)
Restricted Fund Balance	—	—	—	\$1,384,853	\$1,384,853	\$1,384,853
General Fund Contributions	\$3,473,909	\$2,836,141	\$2,387,136	\$774,782	\$774,782	\$(2,061,359)
Total Source of Funds	\$38,406,950	\$6,260,081	\$12,723,047	\$4,666,606	\$4,666,606	\$(1,593,475)

Unit Description

This unit primarily consists of facility costs for shelters and contracts with private non-profit community-based organizations for the provision of housing support, shelter, case management and counseling. The community served includes individuals and families experiencing housing instability and homelessness, as well as victims of domestic violence. Funded programs include Rental Assistance and Rapid Re-Housing, facility operation and service coordination to support the Salinas Housing Advancement, Resource and Education (SHARE) Center (the County’s permanent regional emergency homeless navigation center), operational support for the domestic violence Women’s Shelter, the youth homeless shelter, the Seaside Homeless Shelter for women and families, and the Safe Parking

Program. It also includes funding from the Homeless Housing Assistance Program (HHAP) for individuals experiencing homelessness and for the Coalition of Homeless Services Providers to operate the local HUD Continuum of Care. This unit also funds an operating transfer from Community Action Partnership and IHSS Public Authority for the county share for General Liability-non recoverable. The expenditures provided in this budget are financed by California Department of Social Services; Department of Housing and Community Development; Business, Consumer Services, and Housing Agency; the California Interagency Council on Homelessness; Domestic Violence revenues, and County General Fund Contributions.

IHSS Public Authority

(Budget Unit 8259—Fund 005—Appropriation Unit SOC008)

Use of Funds

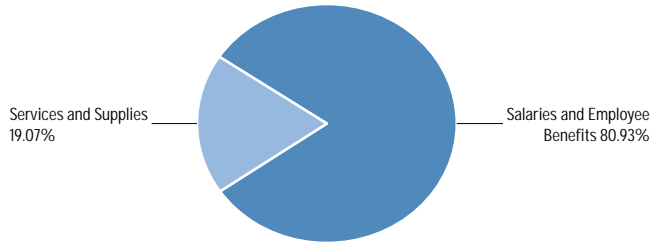

Source of Funds

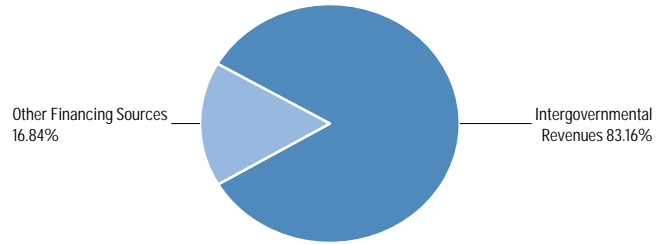

Use of Funds

Expenditures	Prior Year 2021-2022	Adopted Budget 2022-2023	CY Estimate 2022-2023	Requested Budget 2023-2024	Recommended Budget 2023-2024	Recommended Change from Adopted
Salaries and Employee Benefits	\$894,760	\$960,572	\$916,600	\$1,016,899	\$1,016,899	\$56,327
Services and Supplies	\$200,325	\$248,619	\$232,606	\$239,559	\$239,559	\$(9,060)
Other Charges	\$(277,961)	\$(190,457)	\$(190,457)	\$(236,605)	\$(236,605)	\$(46,148)
Subtotal	\$817,124	\$1,018,734	\$958,749	\$1,019,853	\$1,019,853	\$1,119

Source of Funds

Revenues	Prior Year 2021-2022	Adopted Budget 2022-2023	CY Estimate 2022-2023	Requested Budget 2023-2024	Recommended Budget 2023-2024	Recommended Change from Adopted
Revenue from Use of Money & Property	\$(404)	—	\$117	—	—	—
Intergovernmental Revenues	\$734,961	\$848,659	\$788,557	\$848,083	\$848,083	\$(576)
Other Financing Sources	\$69,679	\$170,075	\$170,075	\$171,770	\$171,770	\$1,695
Subtotal	\$804,236	\$1,018,734	\$958,749	\$1,019,853	\$1,019,853	\$1,119
Fund Balance	\$12,888	—	—	—	—	—
Total Source of Funds	\$817,124	\$1,018,734	\$958,749	\$1,019,853	\$1,019,853	\$1,119

Unit Description

The IHSS Public Authority (PA) is administered by Aging and Adult Services Staff. PA staff manage a home care registry that supports IHSS recipients and IHSS social workers with provider referrals. PA staff also plan, arrange and deliver training for IHSS providers. The PA is the administrator of the IHSS provider health insurance plan and serves as employer of record for the purpose of labor negotiations. The PA operates in coordination with the IHSS Program but is an independent authority.

Recommended FY 2023-24 Positions

Classification Code	Classification Label	FTE
14C30	MANAGEMENT ANALYST II	1.00
60C22	SOCIAL WORKER III	2.00
60C80	SOCIAL WORK SUPERVISOR I	1.00
60D11	SOCIAL SERVICES AIDE II	1.00
80E80	PRINCIPAL OFFICE ASSISTANT	2.00
Total		7.00

Military & Veterans Services

(Budget Unit 8260—Fund 001—Appropriation Unit SOC003)

Use of Funds

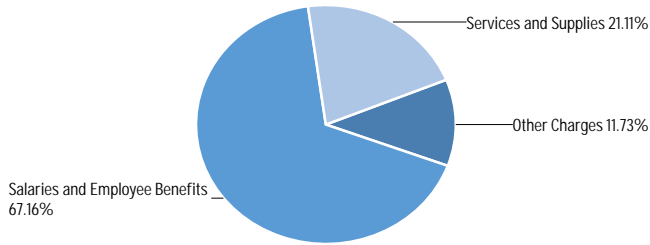

Source of Funds

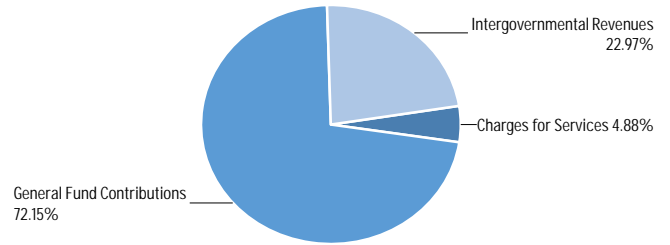

Use of Funds

Expenditures	Prior Year 2021-2022	Adopted Budget 2022-2023	CY Estimate 2022-2023	Requested Budget 2023-2024	Recommended Budget 2023-2024	Recommended Change from Adopted
Salaries and Employee Benefits	\$1,291,532	\$1,437,796	\$1,431,983	\$1,604,536	\$1,582,218	\$144,422
Services and Supplies	\$275,558	\$586,555	\$560,267	\$497,256	\$497,256	\$(89,299)
Other Charges	\$98,788	\$151,638	\$146,638	\$276,448	\$276,448	\$124,810
Capital Assets	\$45,747	—	—	—	—	—
Other Financing Uses	\$715,762	—	—	—	—	—
Subtotal	\$2,427,387	\$2,175,989	\$2,138,888	\$2,378,240	\$2,355,922	\$179,933

Source of Funds

Revenues	Prior Year 2021-2022	Adopted Budget 2022-2023	CY Estimate 2022-2023	Requested Budget 2023-2024	Recommended Budget 2023-2024	Recommended Change from Adopted
Intergovernmental Revenues	\$817,049	\$909,684	\$837,078	\$541,152	\$541,152	\$(368,532)
Charges for Services	\$110,000	\$115,000	\$115,000	\$115,000	\$115,000	—
Subtotal	\$927,049	\$1,024,684	\$952,078	\$656,152	\$656,152	\$(368,532)
Restricted Fund Balance	—	—	—	\$336,131	\$336,131	\$336,131
General Fund Contributions	\$1,500,338	\$1,151,305	\$1,186,810	\$1,385,957	\$1,363,639	\$212,334
Total Source of Funds	\$2,427,387	\$2,175,989	\$2,138,888	\$2,378,240	\$2,355,922	\$179,933

Unit Description

The Military and Veterans' Affairs Office (MVAO) assists and advocates for Veterans, military servicemembers, and their families including but not limited to: Support through the adjudication process with the Department of Veterans Affairs regarding compensation, pension, education, burial, surviving spouse and dependent benefit and entitlement allocations. Assistance with discharge upgrades, securing service and medical records, placement in VA and State medical and domiciliary facilities, survivor assistance for the families of military personnel, and services through the Servicemembers Civil Relief Act. MVAO has very strong collaborative relationships with County, State, and Federal elected officials, community-based organizations such as the United Veterans Council, the Veterans Issues Advisory Committee, and the Military and Veterans Affairs Advisory Commission; local college and university programs such as Hartnell, MPC, CSUMB, and the Middlebury Institute, homeless services providers such as the Coalition of Homeless Services Providers, the Veterans Transition Center, and Nation's Finest; and military installations such as the Presidio of Monterey, Defense Language Institute, Naval Support Activity- Monterey, the Naval

Postgraduate School, and Ft Hunter-Liggett. During FY 2022-23, MVAO served 2,037 unique Veterans, filed 4,077 claim actions, and earned 1,328 compensation awards worth over \$3.3 million in retroactive compensation and over \$6.2 million in recurring payments. MVAO is proud to serve County of Monterey Veterans, servicemembers, and their families.

Recommended FY 2023-24 Positions

Classification Code	Classification Label	FTE
14C31	MANAGEMENT ANALYST III	1.00
14G02	MANAGEMENT ANALYST I	1.00
60U11	MILITARY & VETERANS REPRESENTATIVE II	2.00
60U20	MILITARY & VETERAN AFFAIRS OFFICER	1.00
60U21	MILITARY & VETERANS REPRESENTATIVE III	4.00
80E21	OFFICE ASSISTANT II	1.00
80E80	PRINCIPAL OFFICE ASSISTANT	1.00
Total		11.00

Social Services

(Budget Unit 8262—Fund 001—Appropriation Unit SOC005)

Use of Funds

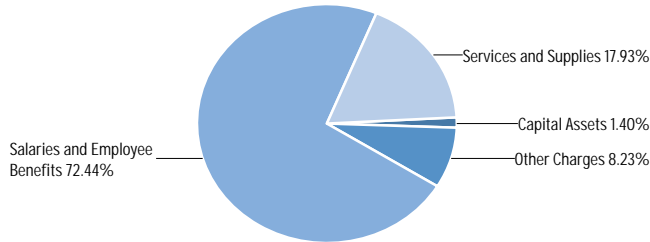

Source of Funds

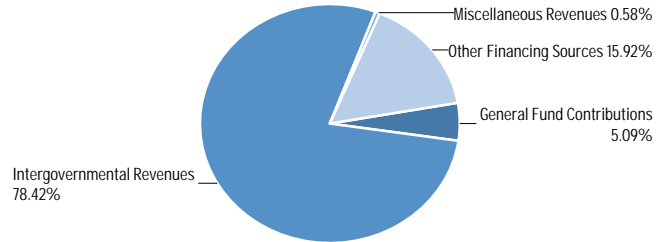

Use of Funds

Expenditures	Prior Year 2021-2022	Adopted Budget 2022-2023	CY Estimate 2022-2023	Requested Budget 2023-2024	Recommended Budget 2023-2024	Recommended Change from Adopted
Salaries and Employee Benefits	\$89,584,141	\$110,064,873	\$99,917,833	\$114,457,448	\$114,457,448	\$4,392,575
Services and Supplies	\$23,650,044	\$27,408,558	\$27,451,406	\$28,323,832	\$28,323,832	\$915,274
Other Charges	\$13,623,058	\$14,980,335	\$15,148,913	\$12,999,975	\$12,999,975	\$(1,980,360)
Capital Assets	\$1,892,853	\$525,000	\$2,358,096	\$2,212,529	\$2,212,529	\$1,687,529
Subtotal	\$128,750,096	\$152,978,766	\$144,876,248	\$157,993,784	\$157,993,784	\$5,015,018

Source of Funds

Revenues	Prior Year 2021-2022	Adopted Budget 2022-2023	CY Estimate 2022-2023	Requested Budget 2023-2024	Recommended Budget 2023-2024	Recommended Change from Adopted
Intergovernmental Revenues	\$93,879,103	\$117,552,660	\$112,854,562	\$123,891,773	\$123,891,773	\$6,339,113
Charges for Services	\$2,000	\$5,000	\$2,000	—	—	\$(5,000)
Miscellaneous Revenues	\$70,808	\$545,785	\$275,769	\$910,000	\$910,000	\$364,215
Other Financing Sources	\$23,192,408	\$25,463,607	\$22,239,221	\$25,156,795	\$25,156,795	\$(306,812)
Subtotal	\$117,144,319	\$143,567,052	\$135,371,552	\$149,958,568	\$149,958,568	\$6,391,516
General Fund Contributions	\$11,605,777	\$9,411,714	\$9,504,696	\$8,035,216	\$8,035,216	\$(1,376,498)
Total Source of Funds	\$128,750,096	\$152,978,766	\$144,876,248	\$157,993,784	\$157,993,784	\$5,015,018

Unit Description

This unit administers a variety of social services programs including: eligibility for CalWORKs cash payments and welfare-to-work services to low-income families; eligibility for General Assistance cash payments to individuals; eligibility for CalFresh (formerly known as Food Stamps) nutrition assistance; Medi-Cal health insurance eligibility; assessment of need for In-Home Supportive Services; Child Welfare Services, Child Abuse Prevention programs, Resource Family Approval (formerly Foster Parent Licensing and approval of adoptive homes), and Adoption services; advocacy to support General Assistance recipients in applying for federal Supplemental Security Income and Adult Protective Services.

These programs are primarily funded by the California Department of Social Services, and the California Department of Health Care Services. State and federal allocations and sales tax realignment contribute to the funding of most of these programs under sharing

formulas, which vary from program to program. Generally, the state cost reimbursements are capped while most federal funding, except for CalWORKs, is open-ended. The operation of the various programs is subject to State and federal mandates, which may impose fiscal or other sanctions for non-compliance.

Social Services Operations and Administration consists of the following main areas:

COMMUNITY BENEFITS: CalFresh, Medi-Cal, CalWORKs Eligibility, Foster Care Eligibility, Quality Control, and Fraud Prevention;

FAMILY AND CHILDREN'S SERVICES: Child Protective Services, the Child Abuse and Neglect Hotline, Child Abuse Prevention programs, Family Maintenance, Family Reunification, Permanency Planning for foster children, Adoptions, Resource Family Approval, the Promoting Safe and Stable Families program, Independent Living Support for Transitional Age Youth, Transitional Services for former

foster youth, and partnership with the CalWORKs Family Stabilization program;

AGING AND ADULT SERVICES: In-Home Supportive Services assessments, Adult Protective Services, Supplemental Security Income (SSI) Advocacy, the Senior Information, Referral and Assistance Hotline;

CALWORKS EMPLOYMENT SERVICES: Welfare-to-Work services for CalWORKs recipients include child care, ancillary/work-related expenses, and transportation assistance. Additional supportive services include the Family Stabilization Program, behavioral health treatment, and domestic violence referral and counseling services, learning disability assessments, employment and job search readiness workshops, and the CalWORKs wage subsidy program;

HUMAN RESOURCES: Employee relations, recruitment, retention, payroll, complaint investigations, civil rights and American Disability Act (ADA) compliance, workers compensation, employee safety, and Department-wide Staff Development; and

ADMINISTRATIVE SERVICES: Financial planning, revenue maximization, accounting, statistical reporting, information systems, procurement, records retention, copying and mail distribution center, facilities management and fleet operations.

Recommended FY 2023-24 Positions

Classification Code	Classification Label	FTE
20B11	ACCOUNTANT II	4.00
20B12	ACCOUNTANT III	1.00
20B93	FINANCE MANAGER II	2.00
20B94	FINANCE MANAGER III	1.00
20B95	FINANCE MANAGER I	1.00
25E21	ELIGIBILITY SPECIALIST II	182.00
25E22	ELIGIBILITY SPECIALIST III	111.00
25E80	ELIGIBILITY SUPERVISOR	40.00
43J05	DEPARTMENTAL INFORMATION SYSTEMS COORDINATOR	5.00
43J09	SENIOR DEPARTMENTAL INFORMATION SYSTEMS COORDINATOR	6.00
43J15	SUPERVISING DEPARTMENTAL INFORMATION SYSTEMS COORDINATOR	2.00
52E22	PUBLIC HEALTH NURSE II	2.00
60C22	SOCIAL WORKER III	38.00
60C24	SOCIAL WORKER V	92.00
60C80	SOCIAL WORK SUPERVISOR I	7.00
60C81	SOCIAL WORK SUPERVISOR II	19.00
60D10	SOCIAL SERVICES AIDE I	2.00
60D11	SOCIAL SERVICES AIDE II	65.00
60H11	EMPLOYMENT & TRAINING WORKER II	1.00
60H21	EMPLOYMENT & TRAINING WORKER III	32.00
60H31	EMPLOYMENT & TRAINING SUPERVISOR	7.00
60H32	SUPERVISING STAFF TRAINER	1.00
60I01	DEPUTY DIRECTOR SOCIAL SERVICES	4.00
60I02	PROGRAM MANAGER II	15.00
70A21	CUSTODIAN	1.00
70F21	COURIER	1.00
70F23	STOREKEEPER	2.00
70F81	SUPERVISING STOREKEEPER	1.00
70N01	OFFICE MAINTENANCE WORKER	3.00
80A31	SECRETARY	13.00
80A32	SENIOR SECRETARY	5.00
80A99	ADMINISTRATIVE SECRETARY-CONFIDENTIAL	1.00
80E21	OFFICE ASSISTANT II	80.00
80E22	OFFICE ASSISTANT III	36.00
80E80	PRINCIPAL OFFICE ASSISTANT	10.00
80E81	SUPERVISING OFFICE ASSISTANT I	17.00
80E82	SUPERVISING OFFICE ASSISTANT II	2.00
80J20	ACCOUNTING CLERICAL SUPERVISOR	1.00
80J30	ACCOUNTING TECHNICIAN	6.00
Total		903.00

Recommended FY 2023-24 Positions

Classification Code	Classification Label	FTE
11A12	DIRECTOR OF SOCIAL SERVICES	1.00
12C13	ASSISTANT DIRECTOR SOCIAL SERVICES	1.00
14B21	ASSOCIATE PERSONNEL ANALYST	4.00
14B32	SENIOR PERSONNEL ANALYST	2.00
14B51	DEPARTMENTAL HR MANAGER-MERIT SYSTEMS	1.00
14C30	MANAGEMENT ANALYST II	19.00
14C31	MANAGEMENT ANALYST III	15.00
14C70	ADMINISTRATIVE SERVICES ASSISTANT	8.00
14C72	ADMINISTRATIVE SERVICES MANAGER	1.00
14H03	PERSONNEL TECHNICIAN-CONFIDENTIAL	5.00
14H70	STAFF TRAINER II	12.00
14N05	ADMINISTRATIVE OPERATIONS MANAGER	1.00
16C87	BUSINESS TECHNOLOGY ANALYST II	5.00
16C88	BUSINESS TECHNOLOGY ANALYST III	2.00
16C93	BUSINESS TECHNOLOGY ANALYST IV	2.00
16F40	DEPARTMENTAL INFORMATION SYSTEMS MANAGER I	1.00
16F41	DEPARTMENTAL INFORMATION SYSTEMS MANAGER II	1.00
20B10	ACCOUNTANT I	3.00

Area Agency on Aging

(Budget Unit 8268—Fund 001—Appropriation Unit SOC010)

Use of Funds

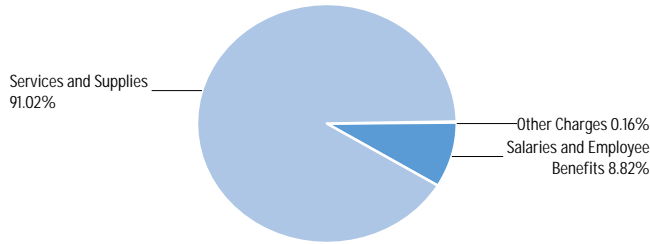

Source of Funds

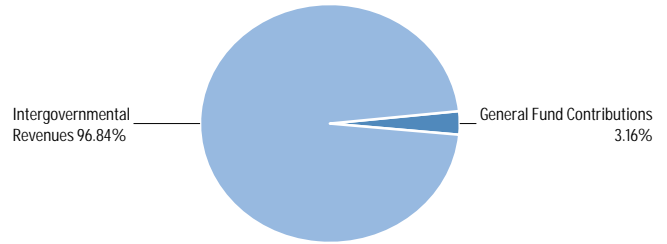

Use of Funds

Expenditures	Prior Year 2021-2022	Adopted Budget 2022-2023	CY Estimate 2022-2023	Requested Budget 2023-2024	Recommended Budget 2023-2024	Recommended Change from Adopted
Salaries and Employee Benefits	\$355,149	\$333,169	\$284,579	\$522,931	\$522,931	\$189,762
Services and Supplies	\$3,482,597	\$3,019,162	\$4,867,467	\$5,399,091	\$5,399,091	\$2,379,929
Other Charges	\$(26,853)	\$(4,180)	\$(4,180)	\$9,487	\$9,487	\$13,667
Subtotal	\$3,810,893	\$3,348,151	\$5,147,866	\$5,931,509	\$5,931,509	\$2,583,358

Source of Funds

Revenues	Prior Year 2021-2022	Adopted Budget 2022-2023	CY Estimate 2022-2023	Requested Budget 2023-2024	Recommended Budget 2023-2024	Recommended Change from Adopted
Intergovernmental Revenues	\$3,337,931	\$3,177,131	\$4,976,846	\$5,744,063	\$5,744,063	\$2,566,932
Subtotal	\$3,337,931	\$3,177,131	\$4,976,846	\$5,744,063	\$5,744,063	\$2,566,932
General Fund Contributions	\$472,961	\$171,020	\$171,020	\$187,446	\$187,446	\$16,426
Total Source of Funds	\$3,810,893	\$3,348,151	\$5,147,866	\$5,931,509	\$5,931,509	\$2,583,358

Unit Description

The Area Agency on Aging (AAA) was established through the Federal Older Americans Act amendments of 1977 with a mission to plan, advocate, and coordinate services for persons 60 years of age and older. The AAA is administered by Aging and Adult Services Branch staff and has a 15-member AAA Advisory Council. The AAA allocates funds to local non-profit organizations serving seniors and family caregivers with the objective of improving quality of life for seniors. Funded services include Health Insurance Counseling and Advocacy Program (HICAP), Ombudsman for Long-Term Care, family caregiver support services, senior nutrition, nutrition and health promotion, legal services and Information, Referral and Assistance programs. Planning efforts focus upon home and

community-based long-term services and supports that promote healthy aging. These activities are funded primarily by the Older American Act, the California Department of Aging, and supplemented by a County share for administrative expenses.

Recommended FY 2023-24 Positions

Classification Code	Classification Label	FTE
14C31	MANAGEMENT ANALYST III	1.00
20B11	ACCOUNTANT II	1.00
60X01	COMMUNITY AFFILIATION MANAGER	1.00
	Total	3.00

Social Services Realignment

(Budget Unit 8425—Fund 025—Appropriation Unit SOC012)

Use of Funds

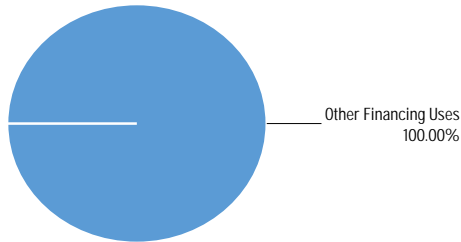

Source of Funds

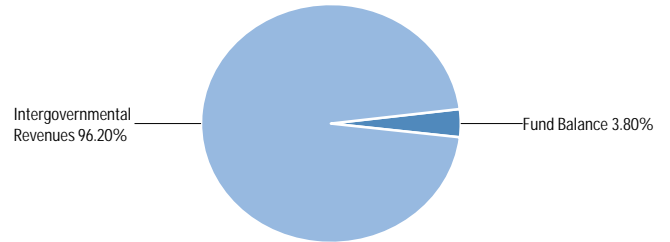

Use of Funds

Expenditures	Prior Year 2021-2022	Adopted Budget 2022-2023	CY Estimate 2022-2023	Requested Budget 2023-2024	Recommended Budget 2023-2024	Recommended Change from Adopted
Other Financing Uses	\$45,902,168	\$43,831,625	\$43,061,931	\$45,539,894	\$45,539,894	\$1,708,269
Subtotal	\$45,902,168	\$43,831,625	\$43,061,931	\$45,539,894	\$45,539,894	\$1,708,269

Source of Funds

Revenues	Prior Year 2021-2022	Adopted Budget 2022-2023	CY Estimate 2022-2023	Requested Budget 2023-2024	Recommended Budget 2023-2024	Recommended Change from Adopted
Intergovernmental Revenues	\$50,529,714	\$43,831,625	\$47,633,364	\$43,811,259	\$43,811,259	\$(20,366)
Subtotal	\$50,529,714	\$43,831,625	\$47,633,364	\$43,811,259	\$43,811,259	\$(20,366)
Fund Balance	\$(4,627,547)	—	\$(4,571,433)	\$1,728,635	\$1,728,635	\$1,728,635
Total Source of Funds	\$45,902,168	\$43,831,625	\$43,061,931	\$45,539,894	\$45,539,894	\$1,708,269

Unit Description

The 1991 Realignment (Realignment) legislation refers to a fiscal arrangement between the State and counties which dedicates portions of Sales Tax and Vehicle License Fee (VLF) revenues to County health, mental health and social services programs. The Realignment was designed to promote greater County responsibility in operating realigned programs, altered cost-sharing ratios, and provided counties with the VLF and Sales Tax as dedicated revenues to pay for the increased program responsibility. The 1991 Realignment differs from the 2011 Public Safety Realignment.

The Realignment impacted the Department of Social Services (DSS) in such programs as: CalWORKs, CalFresh, Foster Care, Adoptions, Child Welfare Services, and In-Home Supportive Services (IHSS). The sales tax and VLF are collected and distributed on a monthly basis by the State Controller's Office and is deposited into the Health and Welfare Realignment Fund (Fund 025) and distributed through operating transfers to various budget units within the Social Services, Probation and Health Departments. Growth funds above the base are distributed by a defined process and estimated annually by the Department of Finance.

Protective Services

(Budget Unit 8464—Fund 022—Appropriation Unit SOC011)

Use of Funds

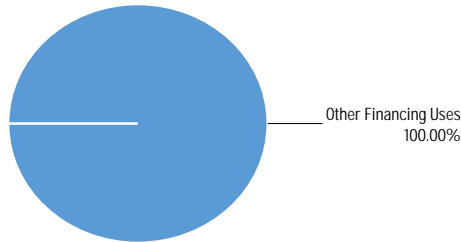

Source of Funds

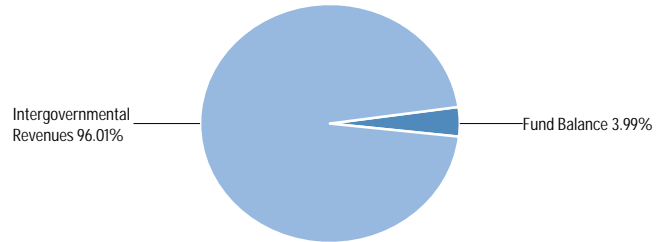

Use of Funds

Expenditures	Prior Year 2021-2022	Adopted Budget 2022-2023	CY Estimate 2022-2023	Requested Budget 2023-2024	Recommended Budget 2023-2024	Recommended Change from Adopted
Other Financing Uses	\$21,482,676	\$24,420,135	\$25,335,755	\$25,479,174	\$25,479,174	\$1,059,039
Subtotal	\$21,482,676	\$24,420,135	\$25,335,755	\$25,479,174	\$25,479,174	\$1,059,039

Source of Funds

Revenues	Prior Year 2021-2022	Adopted Budget 2022-2023	CY Estimate 2022-2023	Requested Budget 2023-2024	Recommended Budget 2023-2024	Recommended Change from Adopted
Intergovernmental Revenues	\$23,752,885	\$24,420,135	\$26,971,786	\$24,462,585	\$24,462,585	\$42,450
Subtotal	\$23,752,885	\$24,420,135	\$26,971,786	\$24,462,585	\$24,462,585	\$42,450
Fund Balance	\$(2,270,209)	—	\$(1,636,031)	\$1,016,589	\$1,016,589	\$1,016,589
Total Source of Funds	\$21,482,676	\$24,420,135	\$25,335,755	\$25,479,174	\$25,479,174	\$1,059,039

Unit Description

Realignment legislation adopted in 2011 and reaffirmed by Proposition 30, requires counties to be responsible for payments of the non-federal portion of Adult Protective Services (APS), Adoption Assistance Program (AAP), Foster Care (FC), and many Child Welfare Services Programs. To fund these new local costs, the State Controller's Office transfers sales taxes to the counties.

The Local Revenue Fund (Fund 022) is established to provide transparency of receipts and transfers of sales taxes associated with the Protective Services Account for 2011 Public Safety Realignment. A process is in place that includes operating transfers between the General Fund units 8255 Out of Home Care and 8262 Social Services and Fund 022 for the realigned programs.

Office for Employment Training

(Budget Unit 8498—Fund 001—Appropriation Unit SOC013)

Source of Funds

Intentionally Left Blank

Source of Funds

Revenues	Prior Year 2021-2022	Adopted Budget 2022-2023	CY Estimate 2022-2023	Requested Budget 2023-2024	Recommended Budget 2023-2024	Recommended Change from Adopted
Revenue from Use of Money & Property	\$(2,661)	—	—	—	—	—
Subtotal	\$(2,661)	—	—	—	—	—
General Fund Contributions	\$2,661	—	—	—	—	—
Total Source of Funds	—	—	—	—	—	—

Unit Description

This unit is for Workforce Innovation and Opportunity Act (WIOA) operations and staff. WIOA staff provide a comprehensive workforce development system to better serve its Adult, Dislocated Worker and Youth participants, and assists job seekers to succeed in the labor market.

Grant funds from the Workforce Development Board were discontinued on June 30, 2019. Only obligatory expenditures for the Countywide Cost Allocation Plan (COWCAP) remain.



This page intentionally left blank.

Library

Departmental Overview:

Monterey County Free Libraries (MCFL) is a public library system whose mission is to bring ideas, inspiration, information and enjoyment to the community. MCFL was established to provide library services to the diverse communities of Monterey County under the County Library Law of 1911. MCFL's operations are primarily financed through its own share of the property tax. Other financial support and funding is received from the Foundation for Monterey County Free Libraries (FMCFL), Friends of the Libraries' groups, and government and private grants.

Programs and Functions:

Community Libraries and Services Access Points: There is a network of 17 branches covering Aromas, Big Sur, Bradley (planned), Buena Vista (Las Palmas), Carmel Valley, Castroville, Gonzales, Greenfield, King City, Marina, Pajaro, Parkfield, Prunedale, San Ardo, San Lucas, Seaside, and Soledad. The Library Department also provides library services through three bookmobiles, Library by Mail, and online through eMCFL.org.

Print, Digital and Unique Collections: MCFL provides public access to a collection of materials for all ages in English and Spanish including books, movies, audiobooks, magazines, newspapers, reference materials, and local history resources. Other materials not owned by MCFL and additional languages are available through internet library loan. A strong online collection includes a digital archive, downloadable e-books, e-audiobooks, digital magazines and newspapers, access to online classes, homework help, veterans resources, language learning programs, job development programs, literacy and citizenship. MCFL lends telescopes, Wi-fi hotspots, "Play and Learn" kits, Book Club to Go bags, and a variety of programs for all ages.

Program and Learning Activities: Free programs for children, teens, adults, and families, including makerspaces and play and learn activities. The annual summer reading program offers performances, activities, and reading encouragement. The library operates an early literacy bookmobile that brings programs and resources to preschools throughout Monterey County with an emphasis on Science and Technology Engineering Mathematics (STREAM).

Staff Assistance: Dedicated staff members are available to assist the public in English and Spanish to get a library card, check out library materials, help find information, answer questions, recommend reading materials, support students with homework, assist people using library technology, and to promote literacy, information resources and community services. Staff serve as branch managers, community liaisons, and connect each community to the services offered by the entire Monterey County Free Libraries system.

Technology: All branches offer free access to computers, the internet and Wifi. Wireless printing, copy machines, FAX services and computer printing are offered along with in person assistance and access to online assistance and classes. In 2022 MCFL added more hotspots, hosted enrollment events for the Affordable Connectivity Program, and provided technology for those with sensory disabilities. Self-check stations were also installed at all locations.

Community Engagement Activities: MCFL supports community engagement activities through partnerships with County Departments, school districts, Cities and other agencies, including mental health awareness, housing application assistance, lunch at the libraries, citizenship classes, voter information/registration, legal services for seniors, and services to families, job seekers, veterans and immigrants. Library meeting rooms are often the site of community outreach from local non-profits, and are fully open to the public again. In the past year, Library facilities have served as Temporary Evacuation Points, COVID testing sites, cooling centers, and water and food distribution areas for the County.

Department's Contribution to Monterey County's Strategic Initiatives:

HEALTH AND HUMAN SERVICES: Improve health and quality of life through County supported policies, programs, and services, promoting access to equitable opportunities for healthy choices and healthy environments in collaboration with communities.



Operating Budget: \$11,410,580
Positions (FTEs): 66.50

Hillary Theyer
County Librarian

Library

Staffing Trends



Expenditure/Revenue History (in millions)

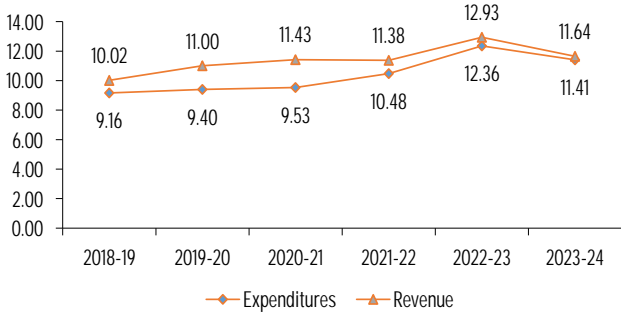

The Library envisions the County as a community where everyone has the opportunity to achieve their potential and pursue happiness. Our mission is to bring ideas, inspiration, information and enjoyment to our community through various delivery methods such as 17 branches, a website, three bookmobiles, and library-by-mail.

Key Performance Measures	2020-21 Actual	2021-22 Actual	2022-23 Mid-Year
Number of visits. Target = 770,000	closed for in person	62,418	249,707
Number of completed technology sessions. Target = 150,000	15,161	167,138	1,206,377
Number of borrowed items. Target = 500,000	248,107	243,575	213,438
Hours of volunteer service. Target = 4,000	200	300	1,702
Number of Children Served in the Homework Center. Target = 10,000	3,200 (online)	0	1,101

Use of Funds

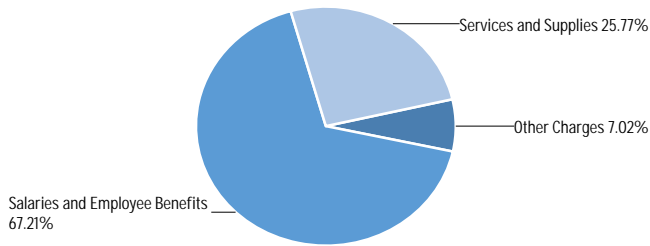

Source of Funds

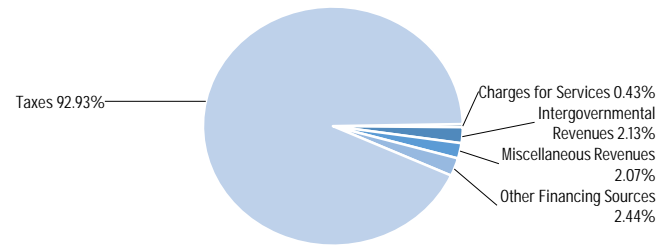

Use of Funds

Expenditures	Prior Year 2021-2022	Adopted Budget 2022-2023	CY Estimate 2022-2023	Requested Budget 2023-2024	Recommended Budget 2023-2024	Recommended Change from Adopted
Salaries and Employee Benefits	\$6,095,367	\$7,528,492	\$6,852,531	\$7,668,842	\$7,668,842	\$140,350
Services and Supplies	\$2,925,365	\$4,838,791	\$4,738,200	\$2,940,527	\$2,940,527	\$(1,898,264)
Other Charges	\$1,147,900	\$771,565	\$771,565	\$801,211	\$801,211	\$29,646
Capital Assets	\$315,589	—	—	—	—	—
Subtotal	\$10,484,222	\$13,138,848	\$12,362,296	\$11,410,580	\$11,410,580	\$(1,728,268)

Source of Funds

Revenues	Prior Year 2021-2022	Adopted Budget 2022-2023	CY Estimate 2022-2023	Requested Budget 2023-2024	Recommended Budget 2023-2024	Recommended Change from Adopted
Taxes	\$10,199,537	\$10,298,831	\$10,298,831	\$10,813,773	\$10,813,773	\$514,942
Revenue from Use of Money & Property	\$26,215	\$7,908	\$7,908	\$8,066	\$8,066	\$158
Intergovernmental Revenues	\$314,921	\$227,847	\$227,847	\$247,646	\$247,646	\$19,799
Charges for Services	\$32,502	\$120,000	\$50,000	\$50,000	\$50,000	\$(70,000)
Miscellaneous Revenues	\$403,149	\$240,783	\$240,783	\$240,783	\$240,783	—
Other Financing Sources	\$399,568	\$2,108,171	\$2,108,171	\$283,889	\$283,889	\$(1,824,282)
Subtotal	\$11,375,893	\$13,003,540	\$12,933,540	\$11,644,157	\$11,644,157	\$(1,359,383)
Fund Balance	\$(891,671)	\$135,308	\$(571,244)	\$(233,577)	\$(233,577)	\$(368,885)
Total Source of Funds	\$10,484,222	\$13,138,848	\$12,362,296	\$11,410,580	\$11,410,580	\$(1,728,268)

Summary of Recommendation

The Fiscal Year (FY) 2023-24 Recommended Budget includes \$11,410,580 in expenditures financed by \$11,644,157 in revenues, adding \$233,577 to fund balance. Both Expenditures and Revenues decrease over the prior fiscal year by \$1,728,268 and \$1,359,383, respectively. The main reason for the decrease is exclusion of a one-time contribution of \$1,800,000 to the City of Gonzales for the new Gonzales Library construction in the prior fiscal year. The decrease is partially offset with increases in salaries and benefits.

Most of the Library's revenues are derived from property taxes which account for \$10,813,773 or 93% of revenues; property taxes are increasing \$514,942 from the adopted budget. Revenues also include a mandated General Fund Contribution (GFC) of \$283,889 for the County Librarian's salary; continuous contributions to programs funded by the Foundation for Monterey County Free Libraries (FMCFL), and various grants including Literacy, Lunch at the Library, and Zip Books. Private philanthropy grants will be carried over to FY 2023-24 and include \$50,000 to fund a Phase II landscaping grant for the San Lucas Library and a \$40,000 grant for furniture for the Pajaro branch.

The Recommended Budget includes 66.5 positions, an increase of 1.0 FTE due to a current year addition of 1.0 Librarian II.

Budget Impacts

Due to the current year floods, the Pajaro Library branch was impacted and books and materials had to be moved and stored. These costs may be carried into FY 2023-24 depending on when work is completed at the branch. Costs will be covered by FEMA reimbursement at a future date, but the Library fund will bear the expense and funding until reimbursement is received.

MCFL is below population, income, and outlet peer libraries in books available per capita; therefore, the budget for books and materials is a concern. MCFL will continue to reexamine purchasing balance between physical and online materials and is actively seeking grant opportunities that can contribute to the materials collections.

The State provided one-time emergency funds which will begin to expire in the next two years, putting support of some programs back onto the MCFL budget to continue offering these resources for the public.

Prior Year Accomplishments

MCFL was awarded a Lunch in the Libraries State grant, which will be carried to FY 2023-24.

Collaborated with partners on grant applications, including the City of Gonzales for the new Gonzales Library, the Public Works Facilities and Parks Department for work on the Pajaro Library, and with ITD to leverage federal E-rate funds to upgrade connectivity of facilities and to offer Affordable Connectivity Program events throughout the County.

Budget Year Goals

Update the strategic plan, complete review of core Library policies, and continue to assess staffing.

Start capital projects including Pajaro rehabilitation, a new Bradley branch, a new Gonzales branch, and planning for a future East Garrison branch.

Install generators for three branches, install electric car charging stations at three branches, and continue enhancement of services as Temporary Evacuation Points in disasters and emergencies.

Utilize a vehicle for the Lunch in the Libraries program to distribute meals, in line with the plans of the grant.

Pending Issues

MCFL continues to support efforts to build a new Bradley Library, working with the City of Gonzales on the Gonzales Community Center, and seeking funding to work with Public Works, Facilities, and Parks for infrastructure improvements on the Porter-Vallejo Mansion, which houses the Pajaro Library. MCFL began Bookmobile services to the communities of East Garrison, Moss Landing and Las Lomas and is focused on moving forward with partnering with the community to plan branch Library services at East Garrison. Growing communities also expect library services, and while the issue of reliable Bookmobiles is currently resolved, expanding staffing to add stops or hours continues to be a major budgetary challenge and there will be a new capital project developed for the eventual replacement of the South County Bookmobile now the oldest in the fleet.

Policy Considerations

There are no policy considerations.

Appropriation Expenditure Detail

	Prior Year 2021-2022	Adopted Budget 2022-2023	CY Estimate 2022-2023	Requested Budget 2023-2024	Recommended Budget 2023-2024	Recommended Change from Adopted	Fund Code	Budget Unit Code
Library (LIB001)	10,484,222	13,138,848	12,362,296	11,410,580	11,410,580	(1,728,268)	003	8141
Subtotal	\$10,484,222	\$13,138,848	\$12,362,296	\$11,410,580	\$11,410,580	\$(1,728,268)		

Budget Units

	Prior Year 2021-2022	Adopted Budget 2022-2023	CY Estimate 2022-2023	Requested Budget 2023-2024	Recommended Budget 2023-2024	Recommended Change from Adopted
Library	\$10,484,222	\$13,138,848	\$12,362,296	\$11,410,580	\$11,410,580	\$(1,728,268)
Subtotal	\$10,484,222	\$13,138,848	\$12,362,296	\$11,410,580	\$11,410,580	\$(1,728,268)

Adopted FY 2022-23 to Recommended FY 2023-24 Positions

Classification Code	Classification Label	Adopted Budget 2021-2022	Adopted Budget 2022-2023	Recommended Budget 2023-2024	Change
11A05	LIBRARY DIRECTOR	1.00	1.00	1.00	0.00
12C04	ASSISTANT LIBRARY DIRECTOR	1.00	1.00	1.00	0.00
14C71	ADMINISTRATIVE SERVICES OFFICER	1.00	1.00	1.00	0.00
43J05	DEPARTMENTAL INFORMATION SYSTEMS COORDINATOR	1.00	1.00	1.00	0.00
65A31	LIBRARIAN I	1.00	1.50	1.50	0.00
65A33	LIBRARIAN II	12.00	9.00	10.00	1.00
65A40	LIBRARIAN III	3.00	4.00	4.00	0.00
65A85	MANAGING LIBRARIAN	2.00	2.00	2.00	0.00
80C01	LIBRARY ASSISTANT I	6.00	5.00	5.00	0.00
80C21	LIBRARY ASSISTANT II	25.00	27.00	27.00	0.00
80C22	LIBRARY ASSISTANT III	11.00	11.00	11.00	0.00
80J21	ACCOUNT CLERK	1.00	1.00	1.00	0.00
80J22	SENIOR ACCOUNT CLERK	1.00	1.00	1.00	0.00
	Total	66.00	65.50	66.50	1.00

Cooperative Extension Service

Departmental Overview:

Cooperative Extension is one of the oldest departments in the County. The University of California (UC) and the County started the local Cooperative Extension office in 1918 for the betterment of the local economy and quality of life. Cooperative Extension is a national program under the United States Department of Agriculture (USDA) with support from the County and the UC to bring the research and knowledge of the land grant universities directly to the community.

Programs and Functions:

AGRICULTURAL PROGRAM: The Agricultural Program is conducted by the Farm Advisors (UC paid academics) who were selected based on their expertise, degrees in their disciplines, and their abilities to teach and work with people. Their mission is to conduct frequent needs assessments and to provide local actionable research and education geared to protecting and promoting Monterey County's farm-based economy, the number one industry. The Farm Advisors have programs in Entomology, Irrigation, Water Quality and Water Policy, Viticulture, Weed Science, Vegetable Crops, Berry Crops, Ornamental Horticulture, and Waste Management. The programs promote the economic viability of the agricultural industry and the protection of environmental resources. Research and educational programs encompass target areas such as sustainable, safe, nutritious food production, economic success in a global economy, and a sustainable, healthy, productive environment.

4-H YOUTH PROGRAM: The mission of the 4-H Youth Development Program is to instill leadership, citizenship and life skills in youth through hands-on learning and community service. In Monterey County there are 15 4-H clubs serving young people ages five through 19. The programs are delivered to youth via trained adult volunteers, and focus on science, engineering and technology, healthy living, and citizenship. High quality 4-H activities engage youth in an environment where youth feel safe and free to share, learn, and grow.

MASTER GARDENER PROGRAM: The mission of the Master Gardener program is to extend research based knowledge and information on home horticulture, pest management and sustainable practices to the residents. In Monterey County 175 volunteers donate over 4,000 hours per year assisting home gardeners, building community and school gardens, and hosting community education demonstrations.

NATURAL RESOURCES PROGRAM: Two cross-county advisors add to in-County expertise, and UC campus specialists bring additional knowledge to bear on specific County issues as they arise. They work to solve local issues such as pine pitch canker, Monterey pine tree health, Sudden Oak Death (SOD), rangeland management, water quality, soil conservation, land use and animal agriculture production.

Department's Contribution to Monterey County's Strategic Initiatives:

Engaging in appropriate development and promotion of economic viability of the agricultural industry supports the Economic Development initiative. Additionally, promoting the use of alternative energy sources, conservation, and related best practices that benefit the environment and create approaches aimed at increasing the overall well-being and quality of life for Monterey County residents supports the Health and Human Services initiative.



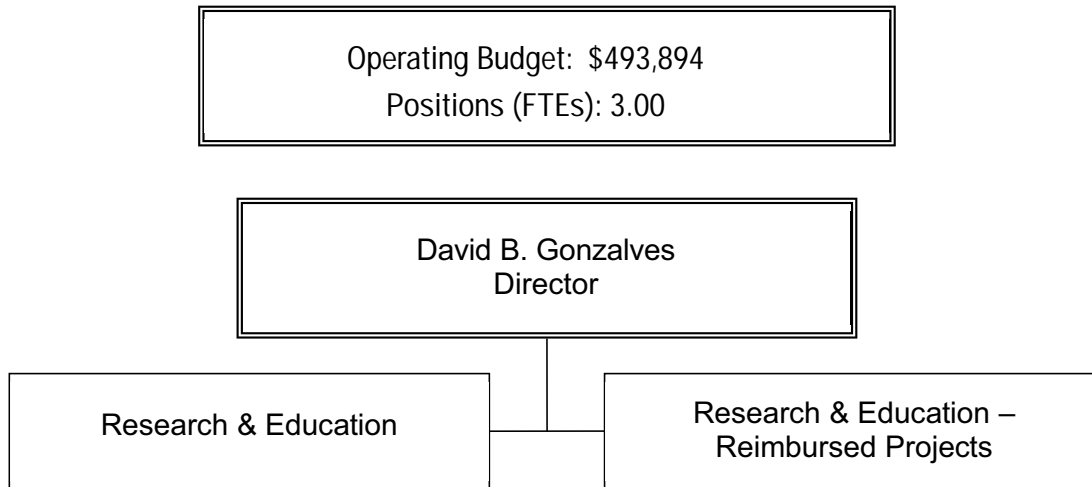

Staffing Trends

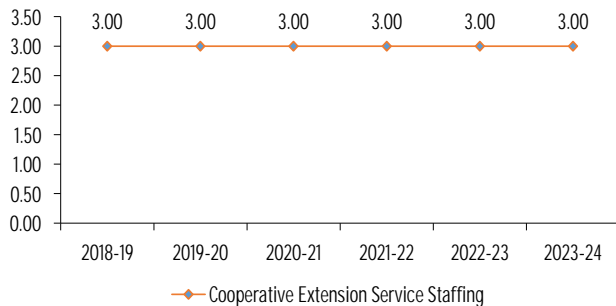

Expenditure/Revenue History (in millions)

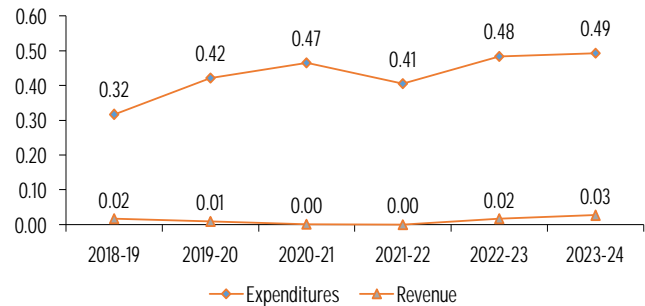

Cooperative Extension utilizes these measures to assist in developing budgets, quantify agricultural research education, and youth development outreach.

Key Performance Measures	2020-21 Actual	2021-22 Actual	2022-23 Mid-Year
Annual contract and grant money generated by Farm Advisors for Monterey County Agricultural Research.	\$3.9 million	\$3.6 million	\$3.8 million
Increase in UC-supported full time FTE	0%	0%	60%
Annual number of workshops, seminars, talks, and conferences presented at. This includes collaborative efforts with other research institutions and privation industry.	COVID restricted	COVID restricted	55
4-H Youth/Volunteer Enrollment & Master Gardener Volunteer Enrollment	875	860	850

Use of Funds

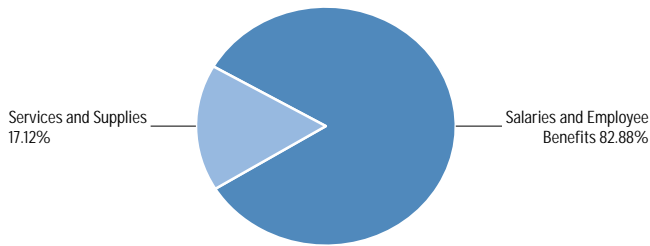

Source of Funds

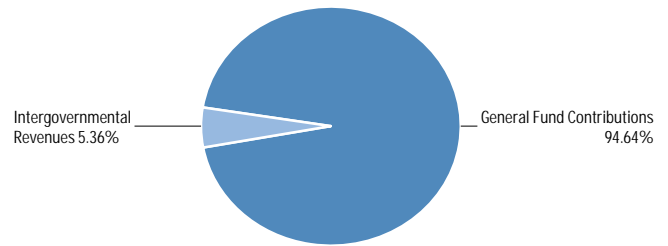

Use of Funds

Expenditures	Prior Year 2021-2022	Adopted Budget 2022-2023	CY Estimate 2022-2023	Requested Budget 2023-2024	Recommended Budget 2023-2024	Recommended Change from Adopted
Salaries and Employee Benefits	\$282,976	\$399,933	\$321,479	\$411,663	\$411,663	\$11,730
Services and Supplies	\$47,066	\$39,390	\$50,351	\$85,057	\$85,057	\$45,667
Other Charges	\$75,928	\$112,024	\$112,024	\$(2,826)	\$(2,826)	\$(114,850)
Subtotal	\$405,970	\$551,347	\$483,854	\$493,894	\$493,894	\$(57,453)

Source of Funds

Revenues	Prior Year 2021-2022	Adopted Budget 2022-2023	CY Estimate 2022-2023	Requested Budget 2023-2024	Recommended Budget 2023-2024	Recommended Change from Adopted
Intergovernmental Revenues	—	\$27,575	\$16,645	\$26,463	\$26,463	\$(1,112)
Subtotal	—	\$27,575	\$16,645	\$26,463	\$26,463	\$(1,112)
General Fund Contributions	\$405,970	\$523,772	\$467,209	\$467,431	\$467,431	\$(56,341)
Total Source of Funds	\$405,970	\$551,347	\$483,854	\$493,894	\$493,894	\$(57,453)

Summary of Recommendation

The Recommended Budget for the UC Cooperative Extension is \$493,894, financed by \$26,463 in program revenue and \$467,431 in general fund contributions (GFC). Recommended appropriations decreased \$57,453, primarily due to a lower cost plan charge.

The Recommended Budget includes \$40,118 in augmentation to partially restore funding for a partial position, in order to maintain a full-time staffing, an operational fleet, and office supplies.

Budget Impacts

There are no budget impacts.

Prior Year Accomplishments

GENERAL: Through the partnership with the UC the Department managed up to \$3,603,426 in research funds and 24 specific research grant projects, provided volunteer services worth approximately \$2,773,856 for youth development and community plant beautification and restoration projects, and provided diagnostic tests/identifications to the agricultural industry, pest management industry and homeowners. The UC also provided support in funding a 60% increase in FTE; filling 1 vacant Farm Advisor position, creating a new Advisor position, and a new Administrator.

ENTOMOLOGY RESEARCH AND EXTENSION PROGRAM: The Department applied research under both commercial (in-field) and laboratory conditions addressing pest issues in vegetables crops grown in Monterey County. The Department extended science-based information on pest management tactics to all growers, stakeholders and community members in the County through sample identifications, blog postings and open-to-the-public seminars. The Departmental goal of the program is to provide information and support on how to implement and improve an Integrated Pest Management (IPM) program in vegetable crops, such as in lettuce, broccoli, or cauliflower. The Department researched areas for this program including, biology and life history of the most economically relevant pests, area-wide monitoring of the fluctuation of pest population densities, insecticide product stewardship, and biological controls. The Farm Advisor for this program moved to a new program in Fiscal Year (FY) 2021-22. The Department continued to maintain the program through collaborative efforts of other Farm Advisors, grower organizations, and research partnerships. In FY 2022-2023, the Department was successful in receiving UC funding support and a new Farm Advisor has been hired to reinstate the program.

PLANT PATHOLOGY RESEARCH AND EXTENSION PROGRAM: The Department's extension plant pathology lab in Salinas is the only one of its kind in the State. The lab allows the Department to conduct in-depth pathology research that benefits local growers. The Farm Advisor supporting this program retired in FY 2018-19. The Department continued to maintain the program specifically supporting mitigating Pythium and Impatiens Necrotic

Spot Virus (INSV) collaborating with industry leaders and other researchers. The Department was successful in reinstating a cross-county Advisor to support his program.

IRRIGATION AND WATER QUALITY RESEARCH AND EXTENSION PROGRAM: Developed and/or evaluated affordable conservation practices that can mitigate run-off from agricultural fields and conducted field trials that demonstrated the combination of vegetated ditches and activated carbon socks to reduce the concentration of the pesticide chlorpyrifos to non-toxic levels in irrigation run-off. Promoted the use of low residue cover crops to reduce winter storm water run-off from vegetable and strawberry fields, and increase aquifer recharge. Expanded the online decision support tool, CropManage (cropmanage.ucanr.edu), developed by the UC Cooperative Extension of Monterey County, which can help growers reduce the use of nitrogen fertilizer by an average of 30% into new crops like viticulture and tree crops. The online application recommends appropriate amounts of water based on the crop and weather data from the six California Irrigation Management Information System (CIMIS) stations located in Monterey County.

VEGETABLE AND WEED SCIENCE RESEARCH AND EXTENSION PROGRAM: Conducted trials with growers to evaluate nitrogen uptake of all key cool season vegetables grown on the Central Coast, the ability of crops to scavenge nitrate from deeper in the soil profile and conduct farm scale evaluation of fertilizer technologies. Evaluated nitrogen fertilizer dynamics in organic production fields, conducted trials on robotic mechanical cultivators, and conducted research on weed control. Along with the Irrigation Program the Vegetable Crop Advisor was critical in adding in advising in the implementation of the New Agricultural Order 3.0.

VITICULTURE RESEARCH AND EXTENSION PROGRAM: Evaluated management tools for powdery mildew and Botrytis bunch rot control in coastal vineyards. Studies of planting and training cultural practices are being evaluated for their potential to promote earlier vine development and productivity for newly developed vineyards. Promoted awareness of local grape growers to assist in the management of mealybug spread of grapevine leafroll virus.

4-H YOUTH PROGRAM: Enrolled 504 youth members, provided 223 adult 4-H volunteers who offered activities and supervision for the youth of Monterey County, and supported 4-H youth groups who provided community service. Due to COVID-19, the program adapted to online versions of implementing programming and outreach to youth.

discovery of new diseases that can be stopped before they spread. Provide anti-bioterrorism diagnostic services for the agricultural industry. Increase assistance to growers to improve irrigation and nitrogen use efficiency.

ENOTOMOLOGY RESEARCH AND EXTENSION PROGRAM: Continue research on arthropods, including insects, to understand the development of the pest and the extent of plant injury generated by their feeding. Monitor fluctuations in pest populations using different traps. Continue testing the performance and application timing in the field of several insecticide active ingredients, both organic and conventional, to control pests in vegetables. Expand studies on biological controls in vegetables, such as using the flower alyssum to attract beneficial insects or the release of laboratory-reared beneficials to control pests.

IRRIGATION AND WATER QUALITY RESEARCH AND EXTENSION PROGRAM: Increase assistance to growers to improve irrigation and nitrogen use efficiency and continue the rigorous research program that evaluates new practices and technologies for improving water and nutrient use efficiency. The program will continue to expand CropManage to additional commodities produced in Monterey County.

VEGETABLE AND WEED SCIENCE RESEARCH AND EXTENSION PROGRAM: Fill a vacant Advisor position for this program.

VITICULTURE RESEARCH AND EXTENSION PROGRAM: Continue disease management studies in vineyards. Continue studies to measure the effects of plant material and cultural practices to promote the early development and productivity of newly established vineyards. Continue to evaluate the use of tall vines at planting to accelerate vine development and increase the production potential of newly established vineyards.

MASTER GARDENER PROGRAM: The Master Gardener program will continue to extend home horticulture, pest management and sustainable practices to residents. Modifications to support social distancing will continue during shelter in place. This includes a hotline service number for questions and online training sessions. The program will continue to expand and will be training 40 new volunteers and increase Latino membership.

Budget Year Goals

Promote the economic sustainability of the County’s economic base from the agricultural industry by conducting research to solve current pest problems. Provide free diagnostic services that lead to the

Pending Issues

There are no pending issues.

Policy Considerations

There are no policy considerations.

Appropriation Expenditure Detail

	Prior Year 2021-2022	Adopted Budget 2022-2023	CY Estimate 2022-2023	Requested Budget 2023-2024	Recommended Budget 2023-2024	Recommended Change from Adopted	Fund Code	Budget Unit Code
Cooperative Extension (EXT001)	396,419	523,772	467,209	\$467,209	\$467,431	(56,341)	001	8021
Cooperative Ext -Reimbursed Projects (EXT001)	9,551	27,575	16,645	26,463	26,463	(1,112)	001	8022
Subtotal	\$405,970	\$551,347	\$483,854	\$493,894	\$493,894	\$(57,453)		

Budget Units

	Prior Year 2021-2022	Adopted Budget 2022-2023	CY Estimate 2022-2023	Requested Budget 2023-2024	Recommended Budget 2023-2024	Recommended Change from Adopted
Cooperative Extension	\$396,419	\$523,772	\$467,209	\$467,431	\$467,431	\$(56,341)
Cooperative Ext -Reimbursed Projects	\$9,551	\$27,575	\$16,645	\$26,463	\$26,463	\$(1,112)
Subtotal	\$405,970	\$551,347	\$483,854	\$493,894	\$493,894	\$(57,453)

Adopted FY 2022-23 to Recommended FY 2023-24 Positions

Classification Code	Classification Label	Adopted Budget 2021-2022	Adopted Budget 2022-2023	Recommended Budget 2023-2024	Change
14C70	ADMINISTRATIVE SERVICES ASSISTANT	1.00	1.00	1.00	0.00
80A31	SECRETARY	1.00	1.00	1.00	0.00
80J30	ACCOUNTING TECHNICIAN	1.00	1.00	1.00	0.00
	Total	3.00	3.00	3.00	0.00

Augmentation Requests

Request Code	Request Name	Ranking Type Name	Requested Amount	Requested FTE	Recommended Budget	Recommended FTE
6210-8021-001-AUG1	Status Quo Filled Secretary	Status Quo Filled Position	25,118	0.25	25,118	0.25
6210-8021-001-AUG2	Status Quo Supplies Printing	Status Quo Other	4,200	-	4,200	-
6210-8021-001-AUG3	New Program Vehicle Usage Costs	New Program/Service w/ General Fund Funding	10,800	-	10,800	-
	Grand Total:		\$40,118	0.25	\$40,118	0.25

Cooperative Extension

(Budget Unit 8021—Fund 001—Appropriation Unit EXT001)

Use of Funds

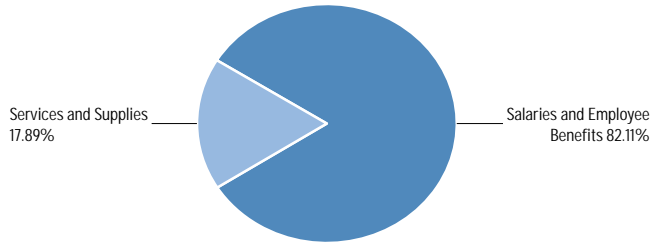

Source of Funds

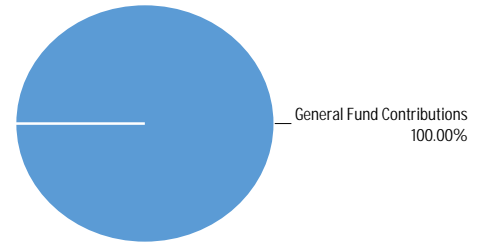

Use of Funds

Expenditures	Prior Year 2021-2022	Adopted Budget 2022-2023	CY Estimate 2022-2023	Requested Budget 2023-2024	Recommended Budget 2023-2024	Recommended Change from Adopted
Salaries and Employee Benefits	\$274,091	\$373,422	\$305,898	\$386,118	\$386,118	\$12,696
Services and Supplies	\$46,400	\$38,326	\$49,287	\$84,139	\$84,139	\$45,813
Other Charges	\$75,928	\$112,024	\$112,024	\$(2,826)	\$(2,826)	\$(114,850)
Subtotal	\$396,419	\$523,772	\$467,209	\$467,431	\$467,431	\$(56,341)

Source of Funds

Revenues	Prior Year 2021-2022	Adopted Budget 2022-2023	CY Estimate 2022-2023	Requested Budget 2023-2024	Recommended Budget 2023-2024	Recommended Change from Adopted
General Fund Contributions	\$396,419	\$523,772	\$467,209	\$467,431	\$467,431	\$(56,341)
Total Source of Funds	\$396,419	\$523,772	\$467,209	\$467,431	\$467,431	\$(56,341)

Unit Description

This Budget Unit description is the same as the Department Description. The programs listed in the Department Description (Agriculture, 4-H Youth, and Natural Resources) are all programs funded by the County of Monterey General Fund.

Recommended FY 2023-24 Positions

Classification Code	Classification Label	FTE
14C70	ADMINISTRATIVE SERVICES ASSISTANT	1.00
80A31	SECRETARY	1.00
80J30	ACCOUNTING TECHNICIAN	1.00
Total		3.00

Cooperative Ext -Reimbursed Projects

(Budget Unit 8022—Fund 001—Appropriation Unit EXT001)

Use of Funds

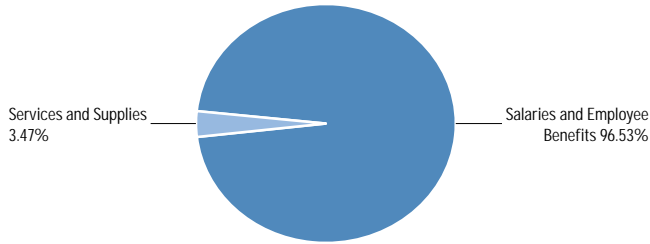

Source of Funds

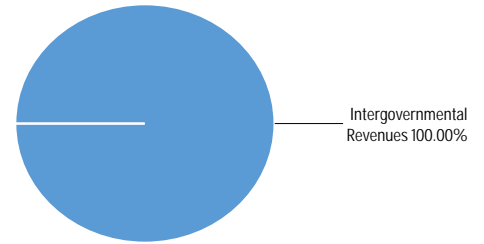

Use of Funds

Expenditures	Prior Year 2021-2022	Adopted Budget 2022-2023	CY Estimate 2022-2023	Requested Budget 2023-2024	Recommended Budget 2023-2024	Recommended Change from Adopted
Salaries and Employee Benefits	\$8,885	\$26,511	\$15,581	\$25,545	\$25,545	\$(966)
Services and Supplies	\$666	\$1,064	\$1,064	\$918	\$918	\$(146)
Subtotal	\$9,551	\$27,575	\$16,645	\$26,463	\$26,463	\$(1,112)

Source of Funds

Revenues	Prior Year 2021-2022	Adopted Budget 2022-2023	CY Estimate 2022-2023	Requested Budget 2023-2024	Recommended Budget 2023-2024	Recommended Change from Adopted
Intergovernmental Revenues	—	\$27,575	\$16,645	\$26,463	\$26,463	\$(1,112)
Subtotal	—	\$27,575	\$16,645	\$26,463	\$26,463	\$(1,112)
General Fund Contributions	\$9,551	—	—	—	—	—
Total Source of Funds	\$9,551	\$27,575	\$16,645	\$26,463	\$26,463	\$(1,112)

Unit Description

This Budget Unit supports the Agricultural Program described in the Department Description. All expenses of this Budget Unit are reimbursed by the University of California (UC). The UC grant

funding supports research and education programs in vegetable diseases, plant nutrition, weed science, viticulture, insect control, waste management, irrigation, water quality and water policy.



This page intentionally left blank.

Natividad Medical Center

Departmental Overview:

Natividad is a 172-bed acute care hospital owned and operated by Monterey County. As a successful designated public safety-net hospital providing healthcare to the residents of Monterey County for over 137 years, Natividad provides healthcare access to all patients regardless of their ability to pay. Natividad is fully accredited by The Joint Commission, has an appointed Board of Trustees, and is under the governance of the Board of Supervisors.

Program and Functions:

Natividad offers inpatient, outpatient, emergency, diagnostic, and specialty medical care and annually provides more than 38,000 patient days and more than 50,000 Emergency Department visits. Natividad is a Level II Trauma Center providing the immediate availability of specialized personnel, equipment, and services to treat the most severe and critical injuries. Natividad also operates a large hospital-based specialty clinic, a primary care clinic, and is the location of outpatient primary care clinics operated by the Monterey County Health Department. Natividad has a medical staff of over 350 physicians.

Natividad is the only teaching hospital on the Central Coast, through its affiliation with the University of California, San Francisco (UCSF). Recognized nationally and internationally as a model program, Natividad's Family Medicine Residency Program is postgraduate training for physicians specializing in family medicine. Approximately one-third (1/3) of graduates remain on the Central Coast to establish a practice.

Natividad's mission is to continually monitor and improve the health of the people, including the vulnerable, through coordinated, affordable, and high-quality healthcare. The vision is to be a healthcare delivery system that collaborates with other providers to offer accessible, high-quality, and high-value healthcare services in a financially stable manner.

Department's Contributions to Monterey County's Strategic Initiatives:

ADMINISTRATION

Promote an organization that practices efficient and effective resource management and is recognized for responsiveness, strong customer orientation, accountability, and transparency.

HEALTH AND HUMAN SERVICES

Improve health and quality of life through County supported policies, programs, and services; promote access to equitable opportunities for healthy choices and health environments in collaboration with communities.

INFRASTRUCTURE

Plan and develop a sustainable, physical infrastructure that improves the quality of life for County residents and supports economic development.



Natividad Medical Center

Operating Budget: \$419,347,035
Positions (FTEs): 1,473.00

Dr. Charles R. Harris
Chief Executive Officer

Natividad Medical Center

Staffing Trends

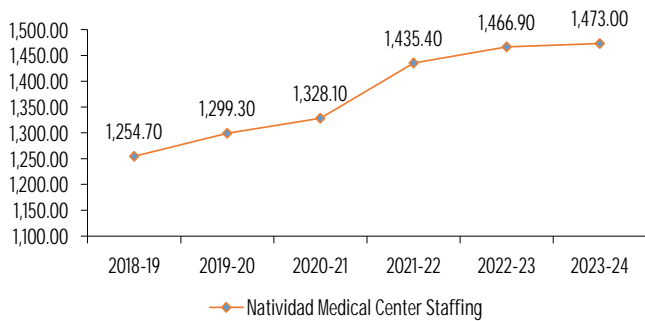

Expenditure/Revenue History (in millions)

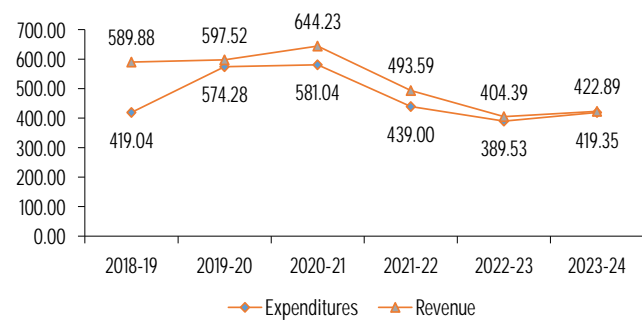

The monitoring of hospital key performance measures help drive performance improvement in the areas of growth of targeted patient service lines, patient experience, and financial performance.

Key Performance Measures	2020-21 Actual	2021-22 Actual	2022-23 Mid-Year
Operating Margin, Target = Budgeted Net Income (in millions of dollars).	\$22.9M	\$18.9M	\$9.2M annualized
Average Daily Census. Target = Budgeted Average Daily Census.	126.8	126.5	127.2
CMS Hospital-acquired Conditions (HAC) reduction Program Total Score, Target = National Benchmark Score.	0.33	0.44	0.29
Rate of Hospital Patient Satisfaction - Nurse Communications. Target = CA Benchmark Score.	80%	76%	73%
Rate of Hospital Patient Satisfaction - Doctor Communications. Target = CA Benchmark Score.	83%	78%	70%
Overall staff turnover rate. Target = <10%.	12.0%	12.1%	12.0%

Use of Funds

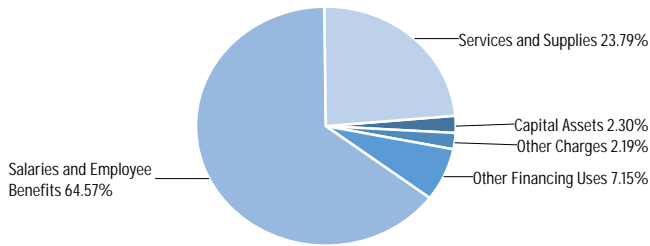

Source of Funds

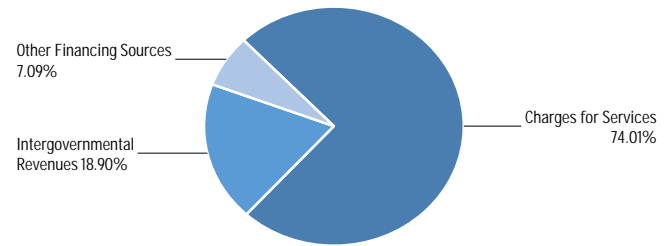

Use of Funds

Expenditures	Prior Year 2021-2022	Adopted Budget 2022-2023	CY Estimate 2022-2023	Requested Budget 2023-2024	Recommended Budget 2023-2024	Recommended Change from Adopted
Salaries and Employee Benefits	\$224,252,479	\$247,115,095	\$230,532,620	\$270,753,726	\$270,753,726	\$23,638,631
Services and Supplies	\$134,793,407	\$89,138,288	\$139,308,143	\$99,757,349	\$99,757,349	\$10,619,061
Other Charges	\$56,743,162	\$8,968,222	\$5,686,309	\$9,191,262	\$9,191,262	\$223,040
Capital Assets	\$10,047,778	\$11,000,000	\$7,000,000	\$9,644,698	\$9,644,698	\$(1,355,302)
Other Financing Uses	\$13,167,495	\$35,000,000	\$7,000,000	\$30,000,000	\$30,000,000	\$(5,000,000)
Subtotal	\$439,004,321	\$391,221,605	\$389,527,072	\$419,347,035	\$419,347,035	\$28,125,430

Source of Funds

Revenues	Prior Year 2021-2022	Adopted Budget 2022-2023	CY Estimate 2022-2023	Requested Budget 2023-2024	Recommended Budget 2023-2024	Recommended Change from Adopted
Fines, Forfeitures, and Penalties	\$166,153	—	—	—	—	—
Revenue from Use of Money & Property	\$2,906,122	—	—	—	—	—
Intergovernmental Revenues	\$182,519,395	\$68,110,440	\$90,008,003	\$79,918,332	\$79,918,332	\$11,807,892
Charges for Services	\$296,404,422	\$291,540,520	\$307,385,673	\$312,968,090	\$312,968,090	\$21,427,570
Miscellaneous Revenues	\$3,453,986	—	—	—	—	—
Other Financing Sources	\$8,143,474	\$35,000,000	\$7,000,000	\$30,000,000	\$30,000,000	\$(5,000,000)
Subtotal	\$493,593,551	\$394,650,960	\$404,393,676	\$422,886,422	\$422,886,422	\$28,235,462
Fund Balance	\$(54,589,231)	\$(3,429,355)	\$(14,866,604)	\$(3,539,387)	\$(3,539,387)	\$(110,032)
Total Source of Funds	\$439,004,321	\$391,221,605	\$389,527,072	\$419,347,035	\$419,347,035	\$28,125,430

Summary of Recommendation

The Recommended Budget for Natividad totals \$419,347,035 in expenditures, financed by \$422,886,422 in revenue, with an estimated increase to the fund balance of \$3,539,387.

Personnel costs and medical operating costs are the largest cost drivers in the budget. Personnel costs are budgeted at \$270,753,726, an increase of \$23,638,631 from the FY 2022-23 Adopted Budget. Employee step advances, higher employee benefit costs, and pay raises also contribute to the increase in personnel costs. The increase includes an additional 6.1 full-time equivalent (FTE) positions where the growth is primarily in nursing and volume-driven departments such as Medical/Surgical and Emergency. Service and supplies are budgeted at \$99,757,349, an increase of \$10,619,061 over the FY 2022-23 Adopted Budget. The increase is largely made up of an anticipated increase in medical supplies and professional services usage.

The \$28,235,462 increase in revenue over the FY 2022-23 Adopted Budget is largely attributed to an increase in revenues from patients

and other services. Revenues from patient and other services are budgeted at \$312,968,090, an increase of \$21,427,570 from the FY 2022-23 Adopted Budget. The increase in patient revenues is from an increase in patient volume and a change in the payor mix resulting in a more favorable collection rate.

Budget Impacts

Labor and benefits costs are major factors with cost increases.

Prior Year Accomplishments

Interpreting Services provided 112,481 total interpretations in 2021, an 18% increase over 2020, including 109,481 Spanish interpretations, 1,740 indigenous language interpretations, 34 ASL interpretations and 1,226 interpretations in other languages.

Natividad, the only teaching hospital on the Central Coast, graduated 10 physicians from its Family Medicine Residency program and welcomed its newest class in June. 1,100 applicants and 125 interviews for 10 positions for the class of 2025. The hospital is also

dedicated to growing resident diversity: 57% of residents from underrepresented minorities in medicine, up 20% in 2017. In addition, 90% of residents are proficient in Spanish. Five out of 10 graduates stayed in the area to practice medicine.

Dr. Chad Harris named CEO. An experienced physician and administrator, Dr. Harris now serves as the hospital's CEO and has held various leadership positions at Natividad over the previous decade.

Natividad continued its Everyone's Harvest Farmers' Market as part of the hospital's ongoing commitment to promoting wellness and healthy eating. The weekly outdoor market allows our community to shop for fresh produce, foods and more. Through Everyone's Harvest, Natividad funded Fresh Rx prescriptions for families for credits of \$25/week in fresh produce in the Farmers' Market. Participating patient results show lower BMI after annual program completion.

Natividad's Esperanza Care program serves 4,500 patients with vital services including primary care, diagnostic testing, and specialty care. Medi-Cal expansion in May 2022 to cover qualified individuals 50-64, resulting in many Esperanza Care patients transitioning to Medi-Cal.

Became a Blue Zones Project Approved Worksite. Blue Zones Project is a community led well-being improvement initiative designed to make healthier choices easier in our community, creating a culture that promotes positive lifestyle changes for workers and the community.

Received CMS Hospital Quality 4-Star Rating. The Center for Medicare & Medicaid Services (CMS), along with key stakeholders, developed methodology to calculate and display overall hospital-level quality using a star rating system. The Overall Star Rating provides consumers with a simple overall rating generated by combining multiple dimensions of quality into a single summary score.

Recognized by the American College of Surgeons (ACS) National Surgical Quality Improvement Program (NSQIP) for meritorious surgical care outcomes in 2022 for 2021. Natividad is one of only 78 health care organizations nationally to receive this honor and the only one in Monterey County.

Kindred Uniform Data System for Medical Rehabilitation Top-Performer Award and ranked #2 for Quality and Outcomes for Acute Rehabilitation Units by Kindred out of 110 Kindred hospital-based acute rehab units in the United States.

Top 10% of Inpatient Rehabilitation Programs in the nation by Uniform Data System (UDS). The ranking certifies that Natividad provides care that is effective, efficient, timely and patient-centered. Natividad Ranked second in the nation out of approximately 900 rehab units for Overall Quality and Outcomes for Acute Rehabilitation Units by UDS.

2022 Blue Distinction Center for Bariatric Surgery designation by Blue Cross Blue Shield. The Blue Distinction Specialty Care program recognizes nationally designated health care facilities that show expertise in delivering improved patient safety and better health outcomes.

Completed year 6 of BETA Healthcare Group with a focus on ED Pediatric Readiness and "Quest for Zero" excellence in the Emergency Department.

Cal Hospital Compare Maternity Honor Roll for the sixth year in a row. The Maternity Honor Roll recognized 141 hospitals in California that met or surpassed the statewide target of 23.9% for C-section rates for first-time mothers with low-risk pregnancies.

BETA Healthcare Group Award of Excellence 14 years running for High Quality Obstetrical Practices achieving 100% Compliance. The OB initiative aims to promote best practices in care delivery to moms and babies in BETA's "Quest for Zero" preventable birth injuries.

The California Perinatal Quality Care Collaborative presented the High Risk Infant Follow-Up (HRIF) Follow-Up Award to the Natividad NICU team. The NICU team ensures babies and parents return to see our medical specialists at least once a year for three years because high-risk infants need extra care during their first years of life.

Completed The Joint Commission Survey in 2021, a four-day re-accreditation survey. To date, one of the most successful Joint Commission surveys with only 15 deficiencies identified out of the 278 standards evaluated. Achieved a 3-year International Accreditation by the Commission on Accreditation of Rehabilitation Facilities International (CARF) for Hospital (Adults) and Hospital: Stroke Specialty Programs (Adults) Programs. 2021 Accreditation as a Comprehensive Center by the Metabolic and Bariatric Surgery Accreditation and Quality Improvement Program (MBSAQIP), a joint Quality Program of the American College of Surgeons (ACS) and the American Society for Metabolic and Bariatric Surgery (ASMBS).

Budget Year Goals

Continue with Covid-19 preparedness in the event of any future surges and providing vaccinations and testing to the community.

Develop programs necessary to meet requirements for the State's CalAim initiative.

Pending Issues

There are no pending issues.

Policy Considerations

There are no policy considerations.

Appropriation Expenditure Detail

	Prior Year 2021-2022	Adopted Budget 2022-2023	CY Estimate 2022-2023	Requested Budget 2023-2024	Recommended Budget 2023-2024	Recommended Change from Adopted	Fund Code	Budget Unit Code
Natividad Medical Center (NMC001)	\$430,861,572	\$366,221,605	\$382,527,072	\$399,347,035	\$399,347,035	\$33,125,430	451	8142
Natividad Medical Center (NMC002)	\$8,142,749	\$25,000,000	\$7,000,000	\$20,000,000	\$20,000,000	\$(5,000,000)	404	8142
Subtotal	\$439,004,321	\$391,221,605	\$389,527,072	\$419,347,035	\$419,347,035	\$28,125,430		

Budget Units

	Prior Year 2021-2022	Adopted Budget 2022-2023	CY Estimate 2022-2023	Requested Budget 2023-2024	Recommended Budget 2023-2024	Recommended Change from Adopted
Natividad Medical Center	\$439,004,321	\$391,221,605	\$389,527,072	\$419,347,035	\$419,347,035	\$28,125,430
Subtotal	\$439,004,321	\$391,221,605	\$389,527,072	\$419,347,035	\$419,347,035	\$28,125,430

Adopted FY 2022-23 to Recommended FY 2023-24 Positions

Classification Code	Classification Label	Adopted Budget 2021-2022	Adopted Budget 2022-2023	Recommended Budget 2023-2024	Change
11A25	HOSPITAL CHIEF EXECUTIVE OFFICER	1.00	1.00	1.00	0.00
12C28	HOSPITAL CHIEF NURSING OFFICER	1.00	1.00	1.00	0.00
12C29	HOSPITAL ASSISTANT ADMINISTRATOR	4.00	3.00	3.00	0.00
14A10	PROJECT MANAGER I	1.00	1.00	1.00	0.00
14A12	PROJECT MANAGER III	1.00	1.00	1.00	0.00
14A70	HOSPITAL REVENUE CYCLE EXAMINER	2.00	2.00	2.00	0.00
14A80	HOSPITAL DECISION SUPPORT MANAGER	1.00	1.00	1.00	0.00
14B01	PERSONNEL ANALYST	0.00	4.00	4.00	0.00
14B21	ASSOCIATE PERSONNEL ANALYST	1.00	1.00	1.00	0.00
14B28	SUPERVISING PERSONNEL ANALYST	1.00	1.00	1.00	0.00
14B32	SENIOR PERSONNEL ANALYST	3.00	3.00	3.00	0.00
14B66	DEPARTMENTAL HR MANAGER	1.00	1.00	1.00	0.00
14C30	MANAGEMENT ANALYST II	8.00	11.00	12.00	1.00
14C31	MANAGEMENT ANALYST III	5.00	5.00	5.00	0.00
14C36	HOSPITAL DECISION SUPPORT ANALYST	2.00	2.00	1.00	(1.00)
14C52	PATIENT FINANCIAL SERVICES DIRECTOR	2.00	3.00	3.00	0.00
14C60	HOSPITAL CHIEF FINANCIAL OFFICER	1.00	1.00	1.00	0.00
14C70	ADMINISTRATIVE SERVICES ASSISTANT	2.00	2.00	2.00	0.00
14E20	BUYER II	5.00	6.00	6.00	0.00
14E90	DIRECTOR OF MATERIAL MANAGEMENT	1.00	1.00	1.00	0.00
14G02	MANAGEMENT ANALYST I	5.00	3.00	1.00	(2.00)
14H03	PERSONNEL TECHNICIAN-CONFIDENTIAL	6.00	3.00	3.00	0.00
14H24	EDUCATOR AND VOLUNTEER COORDINATOR	1.00	1.00	1.00	0.00
14H60	DIRECTOR OF MARKETING AND COMMUNITY RELATIONS	1.00	1.00	1.00	0.00
14H65	MEDICAL STAFF COORDINATOR	1.00	1.00	1.00	0.00
14K26	MANAGED CARE OPERATIONS MANAGER	1.00	1.00	1.00	0.00
14K31	MANAGER OF DIAGNOSTIC IMAGING SERVICES	1.00	1.00	1.00	0.00
14K32	BEHAVIORAL HEALTH SERVICES MANAGER I	1.50	1.50	1.50	0.00
14K33	HOSP DIRECTOR OF ENGINEERING AND SAFETY	1.00	1.00	1.00	0.00
14K35	NMC HUMAN RESOURCES ADMINISTRATOR	1.00	1.00	1.00	0.00
14K43	HOSPITAL CHIEF INFORMATION OFFICER	1.00	1.00	1.00	0.00
14K67	HOSPITAL PURCHASING & MATERIALS SUPPORT DIRECTOR	1.00	1.00	1.00	0.00
14K72	HOSPITAL CHIEF MEDICAL INFORMATION OFFICER	0.00	0.00	1.00	1.00
14M02	HOSPITAL INTERPRETER SERVICES MANAGER	1.00	1.00	1.00	0.00
14M30	TRAUMA PROGRAM MANAGER	0.00	0.00	1.00	1.00
14M31	HOSPITAL DIRECTOR OF NURSING EDUCATION	1.00	1.00	1.00	0.00
14M32	HOSPITAL RISK ASSESSMENT AND COMPLIANCE OFFICER	1.00	1.00	0.00	(1.00)
14M43	HOSPITAL PATIENT SAFETY MANAGER	0.00	0.00	1.00	1.00
14M44	HOSPITAL COMPLIANCE OFFICER	0.00	0.00	1.00	1.00
14N11	OUTPATIENT SERVICES MANAGER II	1.00	3.00	3.00	0.00
14N30	HOSPITAL PATIENT ADMITTING MANAGER	1.00	1.00	1.00	0.00
14N31	HOSPITAL DIRECTOR OF ENVIRONMENTAL SERVICES	1.00	1.00	1.00	0.00
14P10	DIRECTOR OF MEDICAL CENTER PHYSICIAN SERVICES	1.00	1.00	1.00	0.00

Natividad Medical Center

Adopted FY 2022-23 to Recommended FY 2023-24 Positions

Classification Code	Classification Label	Adopted Budget 2021-2022	Adopted Budget 2022-2023	Recommended Budget 2023-2024	Change
16C55	INFORMATION TECHNOLOGY SYSTEMS ANALYST III	2.00	2.00	2.00	0.00
16C60	HOSPITAL SOFTWARE ANALYST I	1.00	0.00	0.00	0.00
16C61	HOSPITAL SOFTWARE ANALYST II	5.00	5.00	4.00	(1.00)
16C62	HOSPITAL SOFTWARE ANALYST III	10.00	10.00	10.00	0.00
16E50	HOSPITAL SECURITY & DATABASE ADMINISTRATOR	3.00	3.00	2.00	(1.00)
20B12	ACCOUNTANT III	2.00	2.00	2.00	0.00
20B91	CHIEF HOSPITAL ACCOUNTANT	1.00	1.00	1.00	0.00
20B92	HOSPITAL CONTROLLER	1.00	1.00	1.00	0.00
20B94	FINANCE MANAGER III	1.00	1.00	1.00	0.00
20B95	FINANCE MANAGER I	1.00	1.00	1.00	0.00
41K01	HOSPITAL NETWORK & SYSTEMS ENGINEER	2.00	2.00	2.00	0.00
43G01	INFORMATION TECHNOLOGY MANAGER	3.00	3.00	2.00	(1.00)
43G04	INFORMATION TECHNOLOGY PROJECT MANAGER III	2.00	2.00	2.00	0.00
43J05	DEPARTMENTAL INFORMATION SYSTEMS COORDINATOR	1.00	1.00	1.00	0.00
43M40	HOSPITAL INFORMATION SYSTEMS SUPPORT TECHNICIAN	4.00	4.00	4.00	0.00
50A21	PHARMACIST I	12.20	12.20	12.20	0.00
50A23	PHARMACY DIRECTOR	1.00	1.00	1.00	0.00
50A25	CLINICAL PHARMACY COORDINATOR	2.00	2.00	2.00	0.00
50D11	MEDICAL LABORATORY TECHNICIAN	1.60	1.80	1.80	0.00
50D12	CLINICAL LABORATORY ASSISTANT	17.90	17.90	17.90	0.00
50D13	SENIOR CLINICAL LABORATORY ASSISTANT	2.00	2.00	2.00	0.00
50D21	CLINICAL LABORATORY SCIENTIST	15.00	15.00	15.00	0.00
50D22	SENIOR CLINICAL LABORATORY SCIENTIST	9.00	9.00	9.00	0.00
50D23	SUPERVISING CLINICAL LABORATORY SCIENTIST	1.00	2.00	2.00	0.00
50D80	CLINICAL LABORATORY MANAGER	1.00	1.00	1.00	0.00
50F10	SUPERVISING THERAPIST	2.00	2.00	2.00	0.00
50F20	OCCUPATIONAL THERAPIST	11.20	11.40	11.40	0.00
50G11	PHYSICAL THERAPIST	13.80	13.80	13.80	0.00
50G41	SPEECH PATHOLOGIST	6.00	6.00	6.00	0.00
50G95	REHABILITATIVE SERVICES MANAGER	1.00	1.00	1.00	0.00
50K19	HEALTH EDUCATION ASSISTANT	4.00	4.00	5.00	1.00
50K23	SENIOR HEALTH EDUCATOR	0.00	0.00	1.00	1.00
50P21	RESPIRATORY CARE PRACTITIONER	19.30	22.90	22.00	(0.90)
50P22	SENIOR RESPIRATORY CARE PRACTITIONER	1.00	1.00	1.00	0.00
50P24	SUPERVISING RESPIRATORY CARE PRACTITIONER	1.00	1.00	1.00	0.00
50P80	DIRECTOR OF RESPIRATORY CARE SERVICES	1.00	1.00	1.00	0.00
50R18	INTERVENTIONAL RADIOLOGIC TECHNOLOGIST	0.00	0.00	4.90	4.90
50R20	SENIOR INTERVENTIONAL RADIOLOGIC TECHNOLOGIST	0.00	0.00	1.00	1.00
50R21	RADIOLOGIC TECHNOLOGIST	26.30	27.00	21.40	(5.60)
50R22	SENIOR RADIOLOGIC TECHNOLOGIST	5.00	5.00	5.00	0.00
50R25	DIAGNOSTIC IMAGING SUPERVISOR	2.00	2.00	2.00	0.00
50R31	SONOGRAPHER	8.60	8.60	5.60	(3.00)
50R32	SENIOR SONOGRAPHER	1.00	1.00	1.00	0.00
50R35	CARDIAC SONOGRAPHER	0.00	0.00	3.00	3.00
50R41	NUCLEAR MEDICINE TECHNOLOGIST	1.00	1.00	1.00	0.00
50T03	HEALTH INFORMATION MANAGEMENT CODER II	7.00	7.00	8.00	1.00
50T22	HEALTH INFORMATION MANAGEMENT CODING SUPERVISOR	1.00	1.00	1.00	0.00
50T33	HEALTH INFORMATION MANAGEMENT DATA INTEGRITY EXAMINER	1.00	0.00	0.00	0.00
50T41	DIRECTOR OF HEALTH INFORMATION MANAGEMENT	1.00	1.00	1.00	0.00
50U17	PHYSICAL THERAPIST ASSISTANT	6.00	6.00	6.00	0.00
50U18	PHARMACY TECHNICIAN	11.40	13.30	14.10	0.80

Adopted FY 2022-23 to Recommended FY 2023-24 Positions

Classification Code	Classification Label	Adopted Budget 2021-2022	Adopted Budget 2022-2023	Recommended Budget 2023-2024	Change
50U20	NURSING ASSISTANT	125.80	106.60	106.80	0.20
50U22	HEALTH CARE TECHNICIAN	3.70	1.60	0.70	(0.90)
50U23	OBSTETRICAL TECHNICIAN	6.30	6.30	6.30	0.00
50U25	ORTHOPEDIC TECHNICIAN	1.00	1.00	2.00	1.00
50U26	SENIOR OBSTETRICAL TECHNICIAN	0.90	0.90	0.90	0.00
50U27	SURGICAL TECHNICIAN	11.60	11.60	11.60	0.00
50U28	SENIOR PHARMACY TECHNICIAN	2.00	2.00	2.00	0.00
50U29	ENDOSCOPY TECHNICIAN	1.90	1.90	1.90	0.00
50U30	DIETITIAN AIDE	8.50	8.50	6.00	(2.50)
50U31	ANESTHESIA TECHNICIAN	0.00	1.80	1.80	0.00
50U42	MEDICAL ASSISTANT	2.00	2.00	3.70	1.70
50U43	CENTRAL STERILE TECHNICIAN	5.80	5.80	5.80	0.00
50U44	SENIOR CENTRAL STERILE TECHNICIAN	1.00	1.00	1.00	0.00
50U51	TELEMETRY TECHNICIAN	4.70	4.70	4.70	0.00
50Y21	DIETITIAN	5.40	5.40	5.40	0.00
50Y31	SUPERVISING DIETITIAN	1.00	1.00	1.00	0.00
52A02	LICENSED VOCATIONAL NURSE	11.30	11.30	10.80	(0.50)
52A16	SUPERVISING NURSE I	15.40	15.40	15.40	0.00
52A17	SUPERVISING NURSE II	1.90	1.90	1.90	0.00
52A19	STAFF NURSE II	369.95	368.05	385.15	17.10
52A20	STAFF NURSE III	36.60	37.40	37.40	0.00
52A21	CLINIC NURSE	4.00	3.00	3.00	0.00
52A22	SENIOR CLINIC NURSE	8.60	13.60	13.60	0.00
52A31	INFECTION CONTROL NURSE	2.00	2.00	2.00	0.00
52A33	CASE MANAGEMENT NURSE	15.00	15.00	13.50	(1.50)
52A34	UTILIZATION MANAGEMENT COORDINATOR	2.00	2.00	2.00	0.00
52A40	HOSPITAL NURSE AUDITOR	2.00	0.00	0.00	0.00
52A50	HOSPITAL QUALITY ASSURANCE NURSE	6.90	8.90	8.40	(0.50)
52A60	CLINICAL NURSE SPECIALIST	4.00	4.00	4.00	0.00
52A83	SUPERVISING CLINIC NURSE	2.00	2.00	2.00	0.00
52A84	QUALITY/COMPLIANCE ADMINISTRATOR	1.00	1.00	1.00	0.00
52A88	NURSING SERVICES DIVISION MANAGER	5.00	6.00	6.00	0.00
52A89	ADMIN NURSE/HOUSE SUPV	6.30	6.30	6.30	0.00
52A92	NURSING SERVICES UNIT MANAGER	3.00	3.00	2.00	(1.00)
52A96	DIRECTOR OF SURGICAL SERVICES	1.00	1.00	1.00	0.00
52A97	CLINIC NURSE PRACTITIONER	2.40	2.40	2.00	(0.40)
52A98	HOSPITAL NURSE PRACTITIONER	12.50	12.80	12.50	(0.30)
54A03	RESIDENT PHYSICIAN III	33.00	33.00	33.00	0.00
54B10	CHIEF OB/GYN SURGEON	1.00	1.00	1.00	0.00
54B12	CONTRACT PHYSICIAN	49.00	61.00	59.50	(1.50)
54B15	NEUROSURGEON	1.00	1.00	1.00	0.00
54B16	TRAUMA SURGEON	3.00	3.00	3.00	0.00
54B17	VASCULAR SURGEON	1.00	1.00	1.00	0.00
54B70	HOSPITAL CHIEF MEDICAL OFFICER	2.00	2.00	2.00	0.00
54B82	CHIEF OF SURGERY	1.00	1.00	1.00	0.00
54B92	ASSISTANT DIRECTOR FAMILY PRACTICE RESIDENCY PROGRAM	1.00	1.00	1.00	0.00
54C03	CLINIC PHYSICIAN ASSISTANT	3.00	2.00	1.00	(1.00)
60B21	PSYCHIATRIC SOCIAL WORKER II	0.00	5.90	6.90	1.00
60C24	SOCIAL WORKER V	11.00	6.00	6.00	0.00
60C81	SOCIAL WORK SUPERVISOR II	1.00	2.00	2.00	0.00
65A22	MEDICAL LIBRARIAN	1.00	1.00	0.00	(1.00)

Natividad Medical Center

Adopted FY 2022-23 to Recommended FY 2023-24 Positions

Classification Code	Classification Label	Adopted Budget 2021-2022	Adopted Budget 2022-2023	Recommended Budget 2023-2024	Change
70A10	HOSPITAL ENVIRONMENTAL SERVICES AIDE	60.70	59.90	59.90	0.00
70A12	HOSPITAL SENIOR ENVIRONMENTAL SERVICES AIDE	3.00	3.80	3.80	0.00
70A13	HOSPITAL SUPERVISING ENVIRONMENTAL SERVICES AIDE	2.00	2.00	2.00	0.00
70C21	GROUNDSKEEPER	1.00	1.00	1.00	0.00
70F21	COURIER	1.00	1.00	1.00	0.00
70F23	STOREKEEPER	14.00	16.00	13.00	(3.00)
70F81	SUPERVISING STOREKEEPER	1.00	2.00	2.00	0.00
70K21	FOOD SERVICE WORKER II	18.50	18.50	18.50	0.00
70K23	COOK	4.50	5.00	5.00	0.00
70K25	SENIOR COOK	2.00	2.00	2.00	0.00
70K80	HEAD COOK	2.00	2.00	2.00	0.00
70K84	HOSPITAL DIRECTOR OF FOOD SERVICES	1.00	1.00	1.00	0.00
70M02	PATIENT TRANSPORTER	6.00	6.00	6.00	0.00
72A23	BUILDING MAINTENANCE WORKER	1.00	1.00	1.00	0.00
72A24	MAINTENANCE PAINTER	2.00	2.00	2.00	0.00
72A80	HOSPITAL MAINTENANCE SUPERVISOR	1.00	1.00	1.00	0.00
72A87	PHYSICAL PLANT MANAGER	1.00	1.00	1.00	0.00
72C19	HOSPITAL MAINTENANCE MECHANIC	9.00	9.00	9.00	0.00
80A32	SENIOR SECRETARY	5.00	6.00	6.00	0.00
80A33	ADMINISTRATIVE SECRETARY	2.00	2.00	2.00	0.00
80A34	SENIOR SECRETARY-CONFIDENTIAL	1.00	1.00	1.00	0.00
80A99	ADMINISTRATIVE SECRETARY-CONFIDENTIAL	3.00	4.00	3.00	(1.00)
80E21	OFFICE ASSISTANT II	8.50	7.50	7.00	(0.50)
80E22	OFFICE ASSISTANT III	17.30	17.30	16.30	(1.00)
80E80	PRINCIPAL OFFICE ASSISTANT	15.25	15.25	17.25	2.00
80E81	SUPERVISING OFFICE ASSISTANT I	1.00	1.00	1.00	0.00
80E82	SUPERVISING OFFICE ASSISTANT II	2.00	2.00	2.00	0.00
80G21	DATA ENTRY OPERATOR II	1.00	1.00	1.00	0.00
80J19	CASHIER	1.50	1.00	1.00	0.00
80J20	ACCOUNTING CLERICAL SUPERVISOR	1.00	1.00	1.00	0.00
80J22	SENIOR ACCOUNT CLERK	4.00	4.00	4.00	0.00
80J30	ACCOUNTING TECHNICIAN	3.00	3.00	4.00	1.00
80K21	MEDICAL UNIT CLERK	20.10	28.60	29.60	1.00
80K23	HOSPITAL MEDICAL INTERPRETER	8.00	10.00	9.00	(1.00)
80L01	PATIENT SERVICES REPRESENTATIVE I	0.00	0.60	0.60	0.00
80L02	PATIENT SERVICES REPRESENTATIVE II	54.70	61.70	58.10	(3.60)
80L03	SENIOR PATIENT SERVICES REPRESENTATIVE	3.00	4.00	4.00	0.00
80L04	SUPERVISING PATIENT SERVICES REPRESENTATIVE	3.00	3.00	4.00	1.00
80M02	PATIENT ACCOUNT REPRESENTATIVE II	30.30	30.30	30.40	0.10
80M03	SENIOR PATIENT ACCOUNT REPRESENTATIVE	3.00	3.00	3.00	0.00
80M05	PATIENT ACCOUNT MANAGER	2.00	2.00	2.00	0.00
80U11	HOSPITAL COMMUNICATIONS OPERATOR II	6.80	7.00	7.00	0.00
80U14	HOSPITAL SUPERVISING COMMUNICATIONS OPERATOR	1.00	1.00	1.00	0.00
	Total	1,435.40	1,466.90	1,473.00	6.10

Natividad Medical Center

(Budget Unit 8142—Fund 451—Appropriation Unit NMC001)

Use of Funds

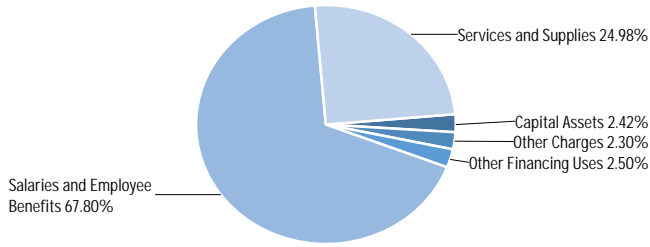

Source of Funds

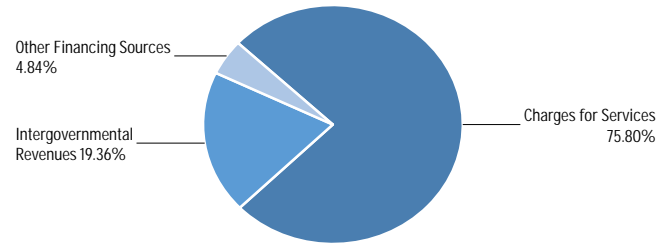

Use of Funds

Expenditures	Prior Year 2021-2022	Adopted Budget 2022-2023	CY Estimate 2022-2023	Requested Budget 2023-2024	Recommended Budget 2023-2024	Recommended Change from Adopted
Salaries and Employee Benefits	\$224,252,479	\$247,115,095	\$230,532,620	\$270,753,726	\$270,753,726	\$23,638,631
Services and Supplies	\$134,793,407	\$89,138,288	\$139,308,143	\$99,757,349	\$99,757,349	\$10,619,061
Other Charges	\$56,743,162	\$8,968,222	\$5,686,309	\$9,191,262	\$9,191,262	\$223,040
Capital Assets	\$10,047,778	\$11,000,000	\$7,000,000	\$9,644,698	\$9,644,698	\$(1,355,302)
Other Financing Uses	\$5,024,746	\$10,000,000	—	\$10,000,000	\$10,000,000	—
Subtotal	\$430,861,572	\$366,221,605	\$382,527,072	\$399,347,035	\$399,347,035	\$33,125,430

Source of Funds

Revenues	Prior Year 2021-2022	Adopted Budget 2022-2023	CY Estimate 2022-2023	Requested Budget 2023-2024	Recommended Budget 2023-2024	Recommended Change from Adopted
Fines, Forfeitures, and Penalties	\$166,153	—	—	—	—	—
Revenue from Use of Money & Property	\$2,906,122	—	—	—	—	—
Intergovernmental Revenues	\$182,519,395	\$68,110,440	\$90,008,003	\$79,918,332	\$79,918,332	\$11,807,892
Charges for Services	\$296,404,422	\$291,540,520	\$307,385,673	\$312,968,090	\$312,968,090	\$21,427,570
Miscellaneous Revenues	\$3,453,986	—	—	—	—	—
Other Financing Sources	\$8,143,474	\$25,000,000	\$7,000,000	\$20,000,000	\$20,000,000	\$(5,000,000)
Subtotal	\$493,593,551	\$384,650,960	\$404,393,676	\$412,886,422	\$412,886,422	\$28,235,462
Fund Balance	\$(62,731,980)	\$(18,429,355)	\$(21,866,604)	\$(13,539,387)	\$(13,539,387)	\$4,889,968
Total Source of Funds	\$430,861,572	\$366,221,605	\$382,527,072	\$399,347,035	\$399,347,035	\$33,125,430

Unit Description

The Natividad Medical Center (NMC) Fund 451 accounts for hospital operations involved in providing health services to County residents. Revenues are principally fees for patient services, payments from federal and State programs (e.g. Medicare, Medi-Cal, and Short Doyle), and realignment revenues. NMC is an enterprise fund that is self supporting by providing goods and services to the public for a fee.

Recommended FY 2023-24 Positions

Classification Code	Classification Label	FTE
11A25	HOSPITAL CHIEF EXECUTIVE OFFICER	1.00
12C28	HOSPITAL CHIEF NURSING OFFICER	1.00
12C29	HOSPITAL ASSISTANT ADMINISTRATOR	3.00
14A10	PROJECT MANAGER I	1.00
14A12	PROJECT MANAGER III	1.00
14A70	HOSPITAL REVENUE CYCLE EXAMINER	2.00
14A80	HOSPITAL DECISION SUPPORT MANAGER	1.00
14B01	PERSONNEL ANALYST	4.00
14B21	ASSOCIATE PERSONNEL ANALYST	1.00
14B28	SUPERVISING PERSONNEL ANALYST	1.00

Recommended FY 2023-24 Positions

Classification Code	Classification Label	FTE
14B32	SENIOR PERSONNEL ANALYST	3.00
14B66	DEPARTMENTAL HR MANAGER	1.00
14C30	MANAGEMENT ANALYST II	12.00
14C31	MANAGEMENT ANALYST III	5.00
14C36	HOSPITAL DECISION SUPPORT ANALYST	1.00
14C52	PATIENT FINANCIAL SERVICES DIRECTOR	3.00
14C60	HOSPITAL CHIEF FINANCIAL OFFICER	1.00
14C70	ADMINISTRATIVE SERVICES ASSISTANT	2.00
14E20	BUYER II	6.00
14E90	DIRECTOR OF MATERIAL MANAGEMENT	1.00
14G02	MANAGEMENT ANALYST I	1.00
14H03	PERSONNEL TECHNICIAN-CONFIDENTIAL	3.00
14H24	EDUCATOR AND VOLUNTEER COORDINATOR	1.00
14H60	DIRECTOR OF MARKETING AND COMMUNITY RELATIONS	1.00
14H65	MEDICAL STAFF COORDINATOR	1.00
14K26	MANAGED CARE OPERATIONS MANAGER	1.00
14K31	MANAGER OF DIAGNOSTIC IMAGING SERVICES	1.00
14K32	BEHAVIORAL HEALTH SERVICES MANAGER I	1.50
14K33	HOSP DIRECTOR OF ENGINEERING AND SAFETY	1.00
14K35	NMC HUMAN RESOURCES ADMINISTRATOR	1.00
14K43	HOSPITAL CHIEF INFORMATION OFFICER	1.00
14K67	HOSPITAL PURCHASING & MATERIALS SUPPORT DIRECTOR	1.00
14K72	HOSPITAL CHIEF MEDICAL INFORMATION OFFICER	1.00
14M02	HOSPITAL INTERPRETER SERVICES MANAGER	1.00
14M30	TRAUMA PROGRAM MANAGER	1.00
14M31	HOSPITAL DIRECTOR OF NURSING EDUCATION	1.00
14M43	HOSPITAL PATIENT SAFETY MANAGER	1.00
14M44	HOSPITAL COMPLIANCE OFFICER	1.00
14N11	OUTPATIENT SERVICES MANAGER II	3.00
14N30	HOSPITAL PATIENT ADMITTING MANAGER	1.00
14N31	HOSPITAL DIRECTOR OF ENVIRONMENTAL SERVICES	1.00
14P10	DIRECTOR OF MEDICAL CENTER PHYSICIAN SERVICES	1.00
16C55	INFORMATION TECHNOLOGY SYSTEMS ANALYST III	2.00
16C61	HOSPITAL SOFTWARE ANALYST II	4.00
16C62	HOSPITAL SOFTWARE ANALYST III	10.00
16E50	HOSPITAL SECURITY & DATABASE ADMINISTRATOR	2.00
20B12	ACCOUNTANT III	2.00
20B91	CHIEF HOSPITAL ACCOUNTANT	1.00
20B92	HOSPITAL CONTROLLER	1.00
20B94	FINANCE MANAGER III	1.00

Recommended FY 2023-24 Positions

Classification Code	Classification Label	FTE
20B95	FINANCE MANAGER I	1.00
41K01	HOSPITAL NETWORK & SYSTEMS ENGINEER	2.00
43G01	INFORMATION TECHNOLOGY MANAGER	2.00
43G04	INFORMATION TECHNOLOGY PROJECT MANAGER III	2.00
43J05	DEPARTMENTAL INFORMATION SYSTEMS COORDINATOR	1.00
43M40	HOSPITAL INFORMATION SYSTEMS SUPPORT TECHNICIAN	4.00
50A21	PHARMACIST I	12.20
50A23	PHARMACY DIRECTOR	1.00
50A25	CLINICAL PHARMACY COORDINATOR	2.00
50D11	MEDICAL LABORATORY TECHNICIAN	1.80
50D12	CLINICAL LABORATORY ASSISTANT	17.90
50D13	SENIOR CLINICAL LABORATORY ASSISTANT	2.00
50D21	CLINICAL LABORATORY SCIENTIST	15.00
50D22	SENIOR CLINICAL LABORATORY SCIENTIST	9.00
50D23	SUPERVISING CLINICAL LABORATORY SCIENTIST	2.00
50D80	CLINICAL LABORATORY MANAGER	1.00
50F10	SUPERVISING THERAPIST	2.00
50F20	OCCUPATIONAL THERAPIST	11.40
50G11	PHYSICAL THERAPIST	13.80
50G41	SPEECH PATHOLOGIST	6.00
50G95	REHABILITATIVE SERVICES MANAGER	1.00
50K19	HEALTH EDUCATION ASSISTANT	5.00
50K23	SENIOR HEALTH EDUCATOR	1.00
50P21	RESPIRATORY CARE PRACTITIONER	22.00
50P22	SENIOR RESPIRATORY CARE PRACTITIONER	1.00
50P24	SUPERVISING RESPIRATORY CARE PRACTITIONER	1.00
50P80	DIRECTOR OF RESPIRATORY CARE SERVICES	1.00
50R18	INTERVENTIONAL RADIOLOGIC TECHNOLOGIST	4.90
50R20	SENIOR INTERVENTIONAL RADIOLOGIC TECHNOLOGIST	1.00
50R21	RADIOLOGIC TECHNOLOGIST	21.40
50R22	SENIOR RADIOLOGIC TECHNOLOGIST	5.00
50R25	DIAGNOSTIC IMAGING SUPERVISOR	2.00
50R31	SONOGRAPHER	5.60
50R32	SENIOR SONOGRAPHER	1.00
50R35	CARDIAC SONOGRAPHER	3.00
50R41	NUCLEAR MEDICINE TECHNOLOGIST	1.00
50T03	HEALTH INFORMATION MANAGEMENT CODER II	8.00
50T22	HEALTH INFORMATION MANAGEMENT CODING SUPERVISOR	1.00
50T41	DIRECTOR OF HEALTH INFORMATION MANAGEMENT	1.00
50U17	PHYSICAL THERAPIST ASSISTANT	6.00

Recommended FY 2023-24 Positions

Classification Code	Classification Label	FTE
50U18	PHARMACY TECHNICIAN	14.10
50U20	NURSING ASSISTANT	106.80
50U22	HEALTH CARE TECHNICIAN	0.70
50U23	OBSTETRICAL TECHNICIAN	6.30
50U25	ORTHOPEDIC TECHNICIAN	2.00
50U26	SENIOR OBSTETRICAL TECHNICIAN	0.90
50U27	SURGICAL TECHNICIAN	11.60
50U28	SENIOR PHARMACY TECHNICIAN	2.00
50U29	ENDOSCOPY TECHNICIAN	1.90
50U30	DIETITIAN AIDE	6.00
50U31	ANESTHESIA TECHNICIAN	1.80
50U42	MEDICAL ASSISTANT	3.70
50U43	CENTRAL STERILE TECHNICIAN	5.80
50U44	SENIOR CENTRAL STERILE TECHNICIAN	1.00
50U51	TELEMETRY TECHNICIAN	4.70
50Y21	DIETITIAN	5.40
50Y31	SUPERVISING DIETITIAN	1.00
52A02	LICENSED VOCATIONAL NURSE	10.80
52A16	SUPERVISING NURSE I	15.40
52A17	SUPERVISING NURSE II	1.90
52A19	STAFF NURSE II	385.15
52A20	STAFF NURSE III	37.40
52A21	CLINIC NURSE	3.00
52A22	SENIOR CLINIC NURSE	13.60
52A31	INFECTION CONTROL NURSE	2.00
52A33	CASE MANAGEMENT NURSE	13.50
52A34	UTILIZATION MANAGEMENT COORDINATOR	2.00
52A50	HOSPITAL QUALITY ASSURANCE NURSE	8.40
52A60	CLINICAL NURSE SPECIALIST	4.00
52A83	SUPERVISING CLINIC NURSE	2.00
52A84	QUALITY/COMPLIANCE ADMINISTRATOR	1.00
52A88	NURSING SERVICES DIVISION MANAGER	6.00
52A89	ADMIN NURSE/HOUSE SUPV	6.30
52A92	NURSING SERVICES UNIT MANAGER	2.00
52A96	DIRECTOR OF SURGICAL SERVICES	1.00
52A97	CLINIC NURSE PRACTITIONER	2.00
52A98	HOSPITAL NURSE PRACTITIONER	12.50
54A03	RESIDENT PHYSICIAN III	33.00
54B10	CHIEF OB/GYN SURGEON	1.00
54B12	CONTRACT PHYSICIAN	59.50
54B15	NEUROSURGEON	1.00
54B16	TRAUMA SURGEON	3.00
54B17	VASCULAR SURGEON	1.00
54B70	HOSPITAL CHIEF MEDICAL OFFICER	2.00
54B82	CHIEF OF SURGERY	1.00
54B92	ASSISTANT DIRECTOR FAMILY PRACTICE RESIDENCY PROGRAM	1.00
54C03	CLINIC PHYSICIAN ASSISTANT	1.00
60B21	PSYCHIATRIC SOCIAL WORKER II	6.90
60C24	SOCIAL WORKER V	6.00
60C81	SOCIAL WORK SUPERVISOR II	2.00

Recommended FY 2023-24 Positions

Classification Code	Classification Label	FTE
70A10	HOSPITAL ENVIRONMENTAL SERVICES AIDE	59.90
70A12	HOSPITAL SENIOR ENVIRONMENTAL SERVICES AIDE	3.80
70A13	HOSPITAL SUPERVISING ENVIRONMENTAL SERVICES AIDE	2.00
70C21	GROUNDSKEEPER	1.00
70F21	COURIER	1.00
70F23	STOREKEEPER	13.00
70F81	SUPERVISING STOREKEEPER	2.00
70K21	FOOD SERVICE WORKER II	18.50
70K23	COOK	5.00
70K25	SENIOR COOK	2.00
70K80	HEAD COOK	2.00
70K84	HOSPITAL DIRECTOR OF FOOD SERVICES	1.00
70M02	PATIENT TRANSPORTER	6.00
72A23	BUILDING MAINTENANCE WORKER	1.00
72A24	MAINTENANCE PAINTER	2.00
72A80	HOSPITAL MAINTENANCE SUPERVISOR	1.00
72A87	PHYSICAL PLANT MANAGER	1.00
72C19	HOSPITAL MAINTENANCE MECHANIC	9.00
80A32	SENIOR SECRETARY	6.00
80A33	ADMINISTRATIVE SECRETARY	2.00
80A34	SENIOR SECRETARY-CONFIDENTIAL	1.00
80A99	ADMINISTRATIVE SECRETARY-CONFIDENTIAL	3.00
80E21	OFFICE ASSISTANT II	7.00
80E22	OFFICE ASSISTANT III	16.30
80E80	PRINCIPAL OFFICE ASSISTANT	17.25
80E81	SUPERVISING OFFICE ASSISTANT I	1.00
80E82	SUPERVISING OFFICE ASSISTANT II	2.00
80G21	DATA ENTRY OPERATOR II	1.00
80J19	CASHIER	1.00
80J20	ACCOUNTING CLERICAL SUPERVISOR	1.00
80J22	SENIOR ACCOUNT CLERK	4.00
80J30	ACCOUNTING TECHNICIAN	4.00
80K21	MEDICAL UNIT CLERK	29.60
80K23	HOSPITAL MEDICAL INTERPRETER	9.00
80L01	PATIENT SERVICES REPRESENTATIVE I	0.60
80L02	PATIENT SERVICES REPRESENTATIVE II	58.10
80L03	SENIOR PATIENT SERVICES REPRESENTATIVE	4.00
80L04	SUPERVISING PATIENT SERVICES REPRESENTATIVE	4.00
80M02	PATIENT FINANCIAL SERVICES SPECIALIST II	30.40
80M03	SENIOR PATIENT FINANCIAL SERVICES SPECIALIST	3.00
80M05	PATIENT ACCOUNT MANAGER	2.00
80U11	HOSPITAL COMMUNICATIONS OPERATOR II	7.00
80U14	HOSPITAL SUPERVISING COMMUNICATIONS OPERATOR	1.00
Total		1,473.00

Natividad Medical Center

(Budget Unit 8142—Fund 404—Appropriation Unit NMC002)

Use of Funds

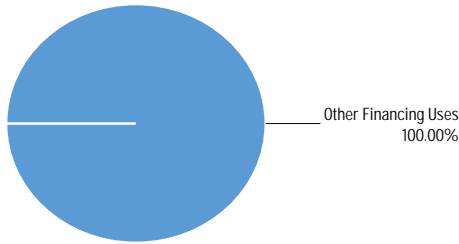

Source of Funds

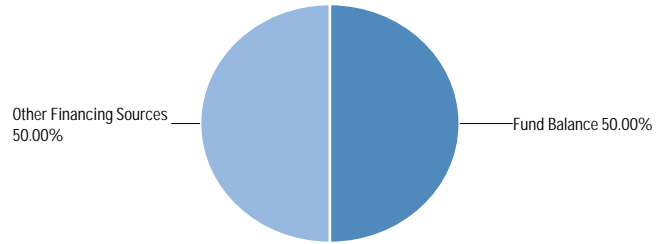

Use of Funds

Expenditures	Prior Year 2021-2022	Adopted Budget 2022-2023	CY Estimate 2022-2023	Requested Budget 2023-2024	Recommended Budget 2023-2024	Recommended Change from Adopted
Other Financing Uses	\$8,142,749	\$25,000,000	\$7,000,000	\$20,000,000	\$20,000,000	\$(5,000,000)
Subtotal	\$8,142,749	\$25,000,000	\$7,000,000	\$20,000,000	\$20,000,000	\$(5,000,000)

Source of Funds

Revenues	Prior Year 2021-2022	Adopted Budget 2022-2023	CY Estimate 2022-2023	Requested Budget 2023-2024	Recommended Budget 2023-2024	Recommended Change from Adopted
Other Financing Sources	—	\$10,000,000	—	\$10,000,000	\$10,000,000	—
Subtotal	—	\$10,000,000	—	\$10,000,000	\$10,000,000	—
Fund Balance	\$8,142,749	\$15,000,000	\$7,000,000	\$10,000,000	\$10,000,000	\$(5,000,000)
Total Source of Funds	\$8,142,749	\$25,000,000	\$7,000,000	\$20,000,000	\$20,000,000	\$(5,000,000)

Unit Description

NMC utilizes Fund 404-Facilities Master Plan Implementation, a County Capital Project Fund, to hold funds for capital projects approved by the Board of Supervisors that are greater than \$100,000 in cost. As expenditures for capital projects are incurred by NMC, the

capital project funds are transferred to Fund 451 (NMC operational fund). This budgetary control prevents commingling of operational and capital funds, and ensures approved funding for capital projects is available to complete projects.

Contributions/Obligations, Liabilities and Other

Introduction

This section of the Recommended Budget describes the various contributions, obligations, liabilities, legislation, and policies that result in either General Fund expenditures or a decrease in General Fund revenue. It also serves as a repository for legislation and policy decisions impacting availability of General Fund financing sources and provides a historic and comparative perspective of those impacts. The discussion in this section is organized into three sub-sections: 1) Contributions/Obligations - expenditures paid directly from the General Fund; 2) Liabilities - liabilities that have both short and long-term costs/benefits; and 3) Other Obligations adopted to benefit the well-being of the County.

Table 1 summarizes all three sub-sections. County contributions and obligations to non-County entities total \$36.0 million in Fiscal Year (FY) 2023-24. Included are the Monterey County Local Agency Formation Commission (LAFCO), economic development and tourism promotion contributions, Trial Court Funding, Proposition 172 sales tax contributions to fire districts and user agencies, and debt service. Total contributions and obligations increased by \$374,393 over the prior year, primarily due to higher contributions toward Fire and User Agencies of 911, offset by lower debt service as some notes mature.

Liabilities total \$773.3 million and are associated with pension benefits, Other Post-Employment Benefits (i.e., retiree health care), workers' compensation, general liability insurance, vacation accruals, certificates of participation debt (COPs), and capital leases.

Other financial commitments total \$8.2 million and include Williamson Act subventions, which decrease property owners' tax obligations in exchange for conserving open space, funding for the Library and Road Funds, and an annual contribution to the Pajaro/Sunny Mesa Community Services District.

Details of the contributions, liabilities, and other commitments are described in the sections that follow. The benefit of this historical perspective is the ability to compare how changes in policy affect funding allocations of the County's General Fund revenues.

Table 1

County Contributions/Obligations/Liabilities/Other Summary Table				
County Contributions/ Obligations	FY 2020-21	FY 2021-22	FY 2022-23	FY 2023-24
LAFCO	298,814	298,814	354,931	363,784
Economic Dev. & Tourism Promotion	1,216,250	2,654,684	2,152,000	2,122,000
Tobacco Settlement	4,607,887	4,720,882	4,316,018	4,470,336
Trial Court - MOE	7,183,910	7,183,910	7,183,910	7,183,910
Trial Court - CFP	777,049	777,049	777,049	777,049
Debt Service	15,324,476	15,414,601	15,391,226	14,840,899
Proposition 172 (Fire Districts)	3,144,425	3,295,753	3,529,729	4,041,183
Proposition 172 (User Agencies)	1,722,029	1,804,903	1,933,039	2,213,134
Total Contributions/ Obligations	34,274,840	36,150,596	35,637,902	36,012,295
Liabilities	FY 2020-21	FY 2021-22	FY 2022-23	FY 2023-24
Miscellaneous - PERS Unfunded Liability	478,258,008	501,239,457	541,223,097	349,878,439
Safety - PERS Unfunded Liability	246,605,358	261,238,361	277,570,360	218,421,070
CalPERS Total	724,863,366	762,477,818	818,793,457	568,299,509
Other Post Employment Benefits	39,088,261	39,088,261	29,270,241	29,270,241
General Liability (Fund 475)*	5,449,000	9,642,000	(3,706,000)	(4,126,000)
Workers' Compensation (Fund 476)*	(18,000)	(851,000)	(3,257,000)	(3,156,000)
Vacation Accruals	31,652,873	35,216,100	48,075,556	40,287,279
Certificates of Participation (COPs)	110,180,196	104,309,791	98,159,837	92,204,445
Capital Leases/Notes/ COPs/Loans	61,877,888	43,831,000	35,552,368	32,862,475
Natividad Medical Center (COPs & Leases)	29,073,594	25,431,389	21,613,806	17,610,555
Total Liabilities	1,002,167,178	1,019,145,359	1,044,502,265	773,252,504
Other	FY 2020-21	FY 2021-22	FY 2022-23	FY 2023-24
Williamson Act Contracts	1,364,162	1,434,923	1,524,606	1,619,894
Library	262,025	275,356	275,356	283,889
Road Fund	5,205,660	5,486,766	5,809,574	6,222,054
Pajaro/Sunny Mesa CSD	25,000	25,000	25,000	25,000
Total Other	6,856,847	7,222,045	7,634,536	8,150,837

**Actuarial info provided is based on a two years' prior basis.

*Actuarial information is based on a two years prior basis.

Contributions/Obligations

LAFCO

The Monterey County Local Agency Formation Commission is a regulatory agency with countywide jurisdiction, established by State law (Cortese-Knox-Hertzberg Act) to discourage urban sprawl and to encourage the orderly and efficient provision of services, such as water, sewer, fire protection, etc. LAFCO is responsible for reviewing and approving proposed jurisdictional boundary changes, including annexations and detachments of territory to and/or from cities and special districts, incorporation of new cities, formation of new special districts, and

consolidation, merger, and dissolution of existing districts.

LAFCO’s primary revenue source is annual contributions from the County, special districts, and cities. Pursuant to Government Code §56381(a), the County pays approximately one-third of LAFCO’s annual operational costs. The remaining is apportioned to the special districts and cities.

Table 2 shows the FY 2023-24 projected total (net) revenues of \$1,106,457 on which LAFCO’s operational cost is based. The County’s share is estimated at \$363,784 or 32.88% of total operations.

Table 2

Local Agency Formation Commission (LAFCO)			
	FY 2021-22	FY 2022-23	FY 2023-24
Operational Costs	1,033,426	1,079,655	1,106,457
County Share	298,814	354,931	363,784
% County Share	28.91%	32.87%	32.88%

Economic Development and Promotion of Tourism

The County’s Development Set-Aside (DSA) Program promotes economic development, tourism, filmmaking, and cultural arts activities that strengthen the County’s economic base by providing a share of its Transient Occupancy Taxes (TOT) to four community organizations. The Monterey County Convention and Visitors Bureau (MCCVB), the Arts Council for Monterey County, the Monterey County Film Commission, and the Monterey County Business Council (MCBC). These organizations submit annual marketing plans outlining specific programs and tasks in support of economic development. The County enters into annual agreements with these agencies to implement the plans. Each agency is described later in this section.

County contributions recognize that the efforts of these agencies can stimulate tourism which in turn may increase Transient Occupancy Tax (TOT). TOT is an assessment by the County, currently 10.5%, on hotel room revenues at all short-term stay hotels and accommodation rentals. The rationale behind levying TOT is to offset a jurisdiction’s General Fund expenses for public safety, street cleaning, street maintenance, etc. that are, to a degree, consumed and utilized by visitors. In addition to the County’s share of TOT, the MCCVB also benefits from a Tourism Improvement District

(TID) assessment, which is a fixed amount per occupied room per night and collected directly by the TID. The fixed amount ranges from \$1.50 to \$2.00 for limited-service lodging establishments to \$7.00 to \$7.50 for luxury lodging businesses. The estimated annual assessment budget is \$8.9 million for FY 2023-24 and provides marketing, group business development, and administration costs.

Chart 1



FY 2018-19 revenues increased nearly 15% from prior year due to the continued recovery from wildfire and storm related damage that occurred in FY 2016-17, and one-time events such as the 2019 Golf US Open, and one-time collections from non-compliant Short-Term Rental operators. With the exclusion of one-time collections, the FY 2019-20 estimate was \$24,948,914, however, actual TOT collections for FY 2019-20 were \$21,773,829 as tourism declined due to stay at home orders resulting from the pandemic. Due to the continued impacts of the pandemic, FY 2020-21 revenue was estimated at \$16,390,728, a decrease of \$5,383,101 (24.7%) from the prior year, however, TOT collections were \$23,528,875. In FY 2021-22, actual TOT revenues increased to an unprecedented \$40,025,756, exceeding pre-pandemic levels. This was largely attributed to eliminating restrictions on travel related to COVID, increasing room capacity (additional rooms), and inflationary factors. The FY 2022-23 adopted budget included \$27,823,878 or 57% above the previous budgeted year due to continued improvement, but current estimates support the prior year levels of TOT. As a result, the FY 2023-24 Recommended Budget includes \$40,025,756 in TOT revenue. TOT is highly volatile as it is driven by

consumer behavior which is highly sensitive to changes in changes in the economy including health restrictions related to outbreaks and economic factors

In FY 2007-08, the Board of Supervisors determined a formula-based approach to funding the MCCVB, the Arts Council for Monterey County, and the Monterey County Film Commission. The contribution is based on a percentage of the County’s TOT from the prior audited fiscal year. The percentages for the MCCVB, the Arts Council and the Film Commission are 6%, 1.98% and .95%, respectively. However, in years of difficult economic circumstances, the County has negotiated its contributions to these organizations. For example, in FY 2018-19, the contributions were based on formulas, however, the additional \$12,790 previously approved for the Business Council in FY 2016-17 and FY 2017-18 was funded with a reduction of the same amount from MCCVB’s contribution. Similarly, the FY 2019-20 Adopted Budget included a capped amount rather than the formula contribution; however, the capped amount was still an increase of \$134,546 or 7% over the prior year.

Table 3 provides the actual contributions for last three fiscal years and the recommended contribution for the upcoming fiscal year. In FY 2020-21, due to budget constraints, and significant reductions anticipated in TOT due to the pandemic, the contributions were not based on the established formula and resulted in a reduction of \$905,750 (42.7%) over the prior year. The Recommended Budget for FY 2021-22 reverted to contributions based on the formula but used FY 2018-19 actuals as the base instead of the FY 2019-20 actuals as the policy dictated to offset the impact the agencies experienced the prior fiscal year. The resulting contribution totaled \$2,654,684, representing an increase of \$1,438,434 (118%) over the prior year.

On April 26,2022, the Board of Supervisors established that moving forward contributions would no longer be based on a formula, but rather capped at the FY 2019-20 amount. According to this direction by the Board, the FY 2022-23 and FY 2023-24 contribution is the same as the FY 2019-20 amount for a total contribution of \$2,122,000; except that the FY 2022-23 budget included a one-time augmentation of \$10,000 to the Film Commission and \$20,000 to the Arts Council. This augmentation was approved as part of the budget hearings by the Board of Supervisors.

Table 3

County TOT Contributions				
	FY 2020-21	FY 2021-22*	FY 2022-23**	FY 2023-24**
MCCVB	750,000	1,716,473	1,400,000	1,400,000
Arts Council	247,500	566,436	440,000	420,000
Film Commission	118,750	271,775	212,000	202,000
Total DSA	1,116,250	2,554,684	2,052,000	2,022,000
Business Council	100,000	100,000	100,000	100,000
Total TOT Contrib.	1,216,250	2,654,684	2,152,000	2,122,000
Contributions as % of TOT	5.17%	6.63%	5.38%	5.30%

*Contributions capped amount rather than formula.
 ** Beginning FY 2022-23 Contributions capped at FY 2019-20 level rather than formula

Monterey County Convention and Visitors Bureau

The MCCVB is a non-profit collaborative of local government and the hospitality community with a mission to grow overnight business from domestic and international leisure and business visitors. This is done through initiatives focusing on marketing, media relations, direct sales, and visitor services.

The contribution to MCCVB for FY 2023-24 is \$1,400,000 a flat amount over the previous fiscal year. In addition to the support that Monterey County provides, MCCVB also receives funding from other local entities. Table 4 provides a four-year summary of funding by other local entities.

Table 4

MCCVB Total Jurisdiction Contributions				
Jurisdiction	FY 2020-21	FY 2021-22	FY 2022-23**	FY 2023-24**
City of Monterey	858,405	1,671,987	1,701,406	1,639,232
Carmel-by-the-Sea	120,040	160,007	200,010	248,032
Pacific Grove	84,549	120,822	148,700	152,947
City of Seaside	54,000	78,000	100,662	103,412
City of Salinas	80,000	100,940	105,723	100,940
City of Marina	68,087	81,888	82,000	135,803
Sand City*	-	-	-	-
Del Rey Oaks*	-	-	-	2,000
Total DSA	1,265,081	2,213,644	2,338,501	2,382,366

*Sand City and Del Rey Oaks do not have TOT
 ** Estimated

Arts Council of Monterey

The County’s contribution to the Arts Council for FY 2023-24 is \$420,000, a \$20,000 decrease from the prior year. This contribution funds the Council’s focus on audience development including increasing awareness of opportunities in the arts; strengthening the ability to attract and serve a more diversified audience; increasing participation of visitors in arts activities; enhancing the arts and education program; increasing partnerships and collaborative efforts to serve youth and families; and administering the re-granting program. The Arts Council also displays artwork in

Contributions/Obligations, Liabilities and Other

the public lobbies at the Monterey County Government Center – Administration Building.

The Monterey County Film Commission

The County’s contribution to the Film Commission for FY 2023-24 is \$202,000, a decrease of \$10,000. The Film Commission is a nonprofit organization, created by the Monterey County Board of Supervisors in 1987 to boost the local economy through on-location film production. The Film Commission markets countywide locations to the film industry and helps facilitate productions. It markets local film crew professionals to visiting production companies, makes referrals to local businesses and services, and offers educational programs related to the film industry. Notable recent productions include Public Broadcasting Service (PBS) and British Broadcasting Company’s (BBC) “Big Blue Live,” and Home Box Office’s (HBO) “Big Little Lies” with Nicole Kidman and Reese Witherspoon.

Monterey County Business Council

The Monterey County Business Council contribution for FY 2023-24 is \$100,000. The Business Council provides collaborative leadership via such programs as the Procurement Technical Assistance Center, Leadership Monterey County, the Monterey Bay Defense Alliance, and the Monterey County (C²) competitive clusters initiative. The Monterey County Business Council forges cross-sector alliances to foster entrepreneurship for job creation and economic diversification, facilitates business-related issues between private and public sectors, educates industry executives on the importance of economic drivers in Monterey County, provides access to expert advice and knowledge in relevant industries, and improves the overall image of the County as a business and technology-friendly community.

Tobacco Settlement Funds

The Tobacco Master Settlement Agreement (MSA) is an agreement between the four largest U.S. tobacco companies (Philip Morris USA, R.J. Reynolds, Brown & Williamson Tobacco Corp., and Lorillard Tobacco Company) and the Attorney General of 46 states (as well as the District of Columbia, Puerto Rico, and the Virgin Islands). The MSA settled Medicaid lawsuits against the tobacco industry for the recovery of tobacco-related health care costs and exempted the companies from private tort liability regarding harm caused by tobacco use. The tobacco companies agreed to pay annual payments to compensate states for some of the medical

costs of caring for persons with smoke-related illnesses. Although the settlement was to compensate for healthcare costs, MSA funds are discretionary, and do not have any restrictions on how the funds may be utilized by the recipient jurisdiction. Monterey County participated in the lawsuit against the tobacco industry and began receiving MSA allocations in FY 2001-02. On March 13, 2001, the Board of Supervisors approved a financial policy of leveraging \$500,000 of Tobacco Settlement Funds annually, for twenty-three years, for health facility improvements.

MSA funds are a fluctuating amount based on several factors, i.e. relative market share (based on 1997 figures), number of cigarettes sold in the State, volume adjustments, etc. Table 5 provides a four-year history of the MSA funding to the County. Since implementation, MSA funds have remained relatively flat.

Table 5

Tobacco Settlement Funds				
	FY 2020-21	FY 2021-22	FY 2022-23*	FY 2023-24*
Tobacco Settlement	4,607,887	4,720,882	4,316,018	4,470,336

*Budget

Trial Court Funding

Maintenance of Effort and 50/50 Revenue Split

On January 1, 1998, AB 233, the Lockyer – Isenberg Trial Court Funding Act of 1997 went into effect. This State bill transferred primary responsibility for funding the courts to the State, including future growth in costs. Additionally, it requires counties to make a capped maintenance of effort (MOE) payment to the State each year for court operations. In return, the State allowed the counties to retain many fines and forfeitures revenue to help fund their MOE payments with the provision that collected amounts that exceed a set amount of revenue must be shared equally between the State and the county (50/50 Revenue Split).

The County’s historical MOE contribution was made up of two components. The expenditure component of \$4,520,911 represented the adjusted FY 1994-95 County expenses for court operations and the revenue component of \$3,330,125 was based on the fine and forfeiture revenue sent to the State in FY 1994-95. The revenue component was reduced to \$2,662,998 in FY 2006-07 because of enacted legislation. The statutory amount of the County’s MOE payment is noticed at the beginning of the payment fiscal year by the State of

California. The MOE payment of \$7,183,910 has remained constant over the past six fiscal years.

County Facilities Payments

The Trial Court Funding Act also transferred responsibility of trial court facilities from counties to the Administrative Office of the Courts (AOC) via transfer agreements that specify the County Facilities Payment (CFP) amount for ongoing operations and maintenance costs.

Although the Trial Court Funding Act was passed in 1997, by 2001, only a small percentage of California county court facilities had transferred responsibility to the State. By July 2008, the only Monterey County facility that was prepared to be transferred was the Marina Courthouse.

The AOC amended the Trial Court Funding Act in 2002 and provided for the application of monetary penalties to incentivize expeditious transfers, where tiers were established based on time period of transfer. If a transfer agreement(s) was executed during the respective time periods, the following applied in addition to the “standard CFP”: Tier 1- December 1, 2008 to March 31, 2009, the inflationary “price” factor of 2.4% was added; Tier 2- April 1, 2009 to December 31, 2009 the State Appropriations Limit was added, which was approximately 5%; and on or after January 1, 2010, no further transfer agreement(s) could be executed.

In July 2008, the County Administrative Office began negotiating with the AOC regarding the transfer of responsibilities for the Marina, Monterey, King City, Salinas North Wing and Juvenile trial court facilities. On December 29, 2008, the County executed a transfer agreement for the Marina Courthouse. The four remaining court facilities were also transferred to the AOC, but title did not pass to the State. Rather, pursuant to the Trial Court Facilities Act, the County retained title to the four facilities due to either long-term debt on the property (Monterey and Salinas North Wing) or the County was the majority occupant and retained management responsibility for the facility. Additionally, the Salinas North Wing facility was undergoing extensive restoration and construction and would not be completed until the summer of 2010. As a result, the Monterey, King City and Juvenile Court facilities transfers were completed via a Transfer of Responsibility Agreement with a Joint Occupancy Agreement, and the Salinas North Wing Facility

transferred via a Transfer of Responsibility with a Deferred Transfer of Title Agreement. All four facility transfer agreements were executed on March 29, 2009, thereby avoiding the 5% CFP penalty assessment. Although the County challenged the levying of a 2.5% penalty on the four remaining courthouses at the Court Facilities Dispute Resolution Committee, that challenge was unsuccessful and a 2.5% penalty (in accordance with the formula set forth above) is annually assessed on all facilities excluding Marina.

Table 7 provides the statutorily calculated CFP terms of the Transfer Agreement(s) the County pays to the AOC for the ongoing operations and maintenance of court facilities within four fiscal years. The CFPs are based on the amount of historical expenditures for the operation and maintenance of court facilities. The County began paying the CFP for the Salinas North Wing court facility when it was completed on October 13, 2010. FY 2011-12 was the first year in which the County remitted the entire CFP amount for all five facilities to the State.

Table 7

County Facility Payments (CFP)				
Facility	FY 2020-21	FY 2021-22	FY 2022-23	FY 2023-24
Marina	96,522	96,522	96,522	96,522
Monterey	167,251	167,251	167,251	167,251
King City	48,079	48,079	48,079	48,079
Juvenile Court	3,960	3,960	3,960	3,960
Salinas North Wing	461,237	461,237	461,237	461,237
Total Annual CFP	777,049	777,049	777,049	777,049

Depending on the percentage change in the National Implicit Price Deflator used to calculate the 2.5% annually assessed penalty, the total CFP could be marginally increased. The State of California typically notifies the County of the calculated CFP amounts for the upcoming fiscal year around April of the current fiscal year.

Proposition 172 – Public Safety Sales Tax

The State’s FY 1993-94 budget agreement transferred \$2.6 billion in property tax revenue from local governments into “educational revenue augmentation funds” (ERAFs) to help the State meet its obligations to K-14 school districts. Most of the diverted tax revenue came from counties, compromising their ability to fund general purpose services, the largest of which is public safety. Proposition 172, passed in the November 1993 statewide election, established a permanent statewide half-cent sales tax for support of

local public safety to partially replace the lost property tax revenue.

Pursuant to Government Code Section 30052, Proposition 172 funds must be placed into a special revenue fund to be expended on such public safety services as sheriffs, fire, county district attorneys, and corrections. Government Code Section 30056 also contains “maintenance of effort” requirements to maintain public safety funding levels. Information on how Proposition 172 revenues are allocated within the County of Monterey is provided below.

Emergency Communications Users’ Offset

Prior to FY 2003-04, the County shared 10% of its Proposition 172 revenues with emergency communications user agencies of 911 dispatch services, to be applied as an offset against the County’s charges to user agencies. In subsequent years, and in response to ongoing fiscal constraints, the County negotiated various agreements to reduce the total Proposition 172 revenue allocated to user agencies. The last of these annual agreements held the Proposition 172 offset flat at \$1,157,179 beginning in FY 2010-11.

In April 2012, the County met with user agencies’ representatives to negotiate a long-term funding solution. The funding for user agencies is based on a formula set at 5.0% of the County’s total Proposition 172 revenues for the most recent audited fiscal year. However, the contribution for FY 2020-21 was a flat amount from the FY 2019-20 contribution due to anticipated decline in Public Safety Sales Tax revenue due to COVID-19. The contribution for FY 2021-22 was based on the formula but utilized FY 2018-19 actuals instead of FY 2019-20 and provided \$1,804,903 to user agencies, of which \$20,822 was funded by ARPA. In FY 2022-23, the contribution is based on the original formula of 5% based on FY 2020-21 actuals. The FY 2023-24 is also based on the original formula based on FY 2021-22 actuals, for a total of \$2,213,134, an increase of \$280,095 (14.5%). Table 8 shows the Proposition 172 negotiated offset provided user agencies beginning in FY 2008-09.

Table 8

Proposition 172	
911 Dispatch User Agencies	
Fiscal Year	Off-Set Contr.
2008-09	1,360,558
2009-10	1,428,617
2010-11	1,157,179
2011-12	1,157,179
2012-13	1,224,879
2013-14	1,357,363
2014-15	1,428,113
2015-16	1,486,369
2016-17	1,559,559
2017-18	1,566,675
2018-19	1,630,239
2019-20	1,722,029
2020-21	1,722,029
2021-22	1,804,903
2022-23	1,933,039
2023-24	2,213,134

Fire Agencies’ Distribution

In 1997, the Board approved a phased, fixed percentage of Proposition 172 revenues for allocation to fire agencies. The allocation started at 8.02% of the County’s total Proposition 172 revenues in FY 1997-1998 and gradually increased to 9.13% by FY 2001-02 and thereafter. In June 2004, the County negotiated a three-year agreement with the Association of Firefighters and Volunteer Fire Companies (the Association) to retain a portion of the 9.13% of Proposition 172 revenues historically contributed to local fire agencies. This agreement resulted in the County retaining 25% of the 9.13% allocation for FY 2004-05 and FY 2005-06. Subsequent agreements reduced the County’s retention to 20% in FY 2006-07, 10% in FY 2007-08, and 5% in FY 2008-09 through FY 2010-11.

The County and the Association agreed to a new negotiated disbursement model for Proposition 172 revenues beginning in FY 2011-12. The County agreed to share with the Association the full 9.13% of Proposition 172 revenues for the most recently audited fiscal year. Like the agreement with emergency communications user agencies, the current methodology ties future allocations to audited actuals, resulting in greater predictability for budgeting purposes, and eliminating the need for year-end reconciliations and payment “true-ups.”

Due to favorable Proposition 172 revenue trends in recent years, the contributions to the Association have grown \$1,562,639 since FY 2012-13. Similar to the contribution for user agencies, the contribution of \$3,144,425 for FY 2020-21 was flat from the FY 2019-20 contribution due to anticipated reductions in Public Safety Sales Tax revenue as a result of COVID-19. In FY 2021-22 the contribution was based on the formula, but utilized FY 2018-19 actuals instead of FY 2019-20, amounting to \$3,295,753, of which \$38,021 was funded by ARPA. In FY 2022-23 and FY 2023-24, the contribution is based on original formula utilizing two prior year actuals. The FY 2023-24 contribution provides \$4,041,183 or an increase of \$511,454 (14.5%) from the prior year.

The various fire agencies allocate the Proposition 172 revenues amongst themselves via their own allocation formula. Table 9 lists the estimated allocation for FY 2023-24.

Table 9

Proposition 172 FY 2023-24 Fire Agencies Allocation		
Fire Agency	Allocation	% of Total Allocation
Aromas FPD	\$101,765	2.52%
Big Sur VFB	111,109	2.75%
Cachagua FPD	67,780	1.68%
Carmel Highlands FPD	283,828	7.02%
Carmel Valley FPD	585,147	14.48%
Cypress FPD	362,934	8.98%
Gonzales Rural FPD	51,280	1.27%
Greenfield FPD	51,280	1.27%
Mid Coast VFC	67,780	1.68%
North County FPD	897,199	22.20%
Pebble Beach CSD	289,393	7.16%
Monterey County Regional	832,403	20.60%
San Ardo VFC	51,280	1.27%
Soledad Rural FPD	51,280	1.27%
Spreckles CSD	65,988	1.63%
So. Monterey County FP	170,737	4.22%
Total	\$4,041,183	100%

County Agency Distribution

The State Board of Equalization apportions Proposition 172 revenues to each county based on its proportionate share of statewide taxable sales. Due to the disbursement cycle of Proposition 172 revenues from the State

Controller, each fiscal year's actual Proposition 172 revenues are not known until August of the following fiscal year. Therefore, actual FY 2022-23 and FY 2023-24 revenues at the time of this publication are estimates. Proposition 172 revenues continue to improve from FY 2019-20, which saw a decrease due to the pandemic.

Table 10

Proposition 172 Allocation by Entity			
Entity	FY 2021-22**	FY 2022-23	FY 2023-24
Fire District	\$3,295,753	\$3,529,729	\$4,041,183
User Agencies of 911 Ctr.	1,804,903	1,933,039	2,213,134
County Public Safety*	38,437,415	37,520,776	39,336,243
Total	\$43,538,071	\$42,983,544	\$45,590,560

*Shaded figures are estimated

Table 11 further breaks down the negotiated estimated County Public Safety Proposition 172 revenue allocation by County department.

Table 11

Proposition 172 County Public Safety Allocations			
Department	FY 2021-22	FY 2022-23	FY 2023-24
Sheriff	21,852,484	21,455,322	22,596,671
Probation	7,639,738	6,935,642	7,254,548
District Attorney	6,303,005	6,721,065	7,125,759
Emergency Communicatio	2,642,187	2,408,748	2,359,264
Total	\$ 38,437,415	\$ 37,520,777	\$ 39,336,242

shaded figures are estimates

Liabilities

CalPERS

The County of Monterey contributes to the California Public Employees' Retirement System (CalPERS), which manages pension and health benefits for California public employees, retirees, and their families. As of June 30, 2022, CalPERS has 1,380,611 active and inactive (no longer work for a CalPERS employer with service credit on account) members and 775,285 retirees, beneficiaries and survivors receiving a monthly allowance for a total membership of 2,155,896. The CalPERS investment portfolio market value totaled \$439.4 billion as of June 30, 2022, and realized a net investment return of (6.1%) over the same fiscal year (CalPERS Facts at a Glance FY 2021-22).

CalPERS provides benefits such as retirement, deferred compensation, disability retirement, death

Contributions/Obligations, Liabilities and Other

benefits, health benefits, and long-term care benefits to all State government employees and, by contract, to local agencies and school employees. As an active plan member, the County is required to contribute to the pension fund. Before FY 2017-18, the County contributed an overall percent of payroll. Beginning with FY 2017-18, the County's contribution has two components: a percentage of the annual covered salary of its miscellaneous and public safety employees and a lump sum to pay down its unfunded liability.

Retirement benefits are calculated using an employee's years of service credit, age at retirement, and final compensation (average salary for a defined period of employment). The actual retirement formulas are determined by the employer (State, school, or local public agency), occupation (miscellaneous [general office and others], safety, industrial, or peace officer/firefighter), and the specific provisions in the contract between CalPERS and the employer. Prior to the enactment of the Public Employees' Pension Reform Act of 2013 (PEPRA) the County utilized the miscellaneous formula of 2% at the age of 55 years and 3% at 50 for safety employees. When PEPRA went into effect on January 1, 2013, the miscellaneous formula for new County employees (new hires without prior membership in any California public retirement system) was designated at 2% at the age of 62, with a minimum retirement age of 52 and 2.7% at 57 for safety employees. Additional information regarding PEPRA can be found in the following pages.

Employer and Employee Contributions to CalPERS

Prior to changes made in FY 2011-12, the County contributed the employer share and varying amounts of the employees' shares to CalPERS to fund retirement benefits for its employees. In the case of miscellaneous employees, the County paid the entire 7% of the employee contribution. For those covered by the safety formula, the County paid differing amounts of the employee's share depending upon negotiated bargaining unit agreements. Effective October 8, 2011, the County implemented negotiated agreements with its bargaining units wherein employees paid an increased portion. In general, most employees began paying 3.5% of the employee contribution while certain public safety bargaining units' employee contribution amount was increased by 4.5%.

Effective November 2013, most employee groups received a salary increase of 3.5%. The increase was

negotiated in exchange for employees paying the remaining 3.5% of the "employee share" of PERS retirement costs (totaling 7%) formerly covered by the County. Public safety employees were already paying in excess of the full employee share with the FY 2011-12 changes.

Table 12 provides the employer contributions required to be paid by the County. These figures are provided in the annual CalPERS actuarial report published each year in October.

Table 12

Miscellaneous Plan Required Contributions				
	FY 2020-21	FY 2021-22	FY 2022-23	FY 2023-24
Required Employer Contribution (in Projected Dollars)				
Employer Normal Cost	\$33,221,859	\$32,164,937	\$32,114,514	\$38,026,191
Unfunded Liability Contribution	33,543,803	39,502,875	44,758,007	43,832,501
Total Employer Contribution	66,765,662	71,667,812	76,872,521	81,858,692
Annual Lump Sum Prepayment Option*	32,428,018	38,188,871	43,269,199	42,414,136
Required Employer Contribution (Percentage of Payroll)				
Employer Normal Cost	9.22%	8.50%	8.32%	9.23%
Unfunded Liab. Contr.	9.31%	10.44%	11.60%	10.64%
Total Employer Rate**	18.52%	18.94%	19.92%	19.87%
Employee Contributions				
Employee Contributions	23,953,912	26,186,043	26,749,228	28,591,740
Employee Rate	6.65%	6.92%	6.93%	6.94%
Safety Plan Required Contributions				
	FY 2020-21	FY 2021-22	FY 2022-23	FY 2023-24
Required Employer Contribution (in Projected Dollars)				
Employer Normal Cost	\$11,495,296	\$11,648,092	\$11,420,571	\$12,582,706
Unfunded Liability Contribution	16,448,011	19,160,858	21,352,168	20,883,192
Total Employer Contribution	27,943,307	30,808,950	32,772,739	33,465,898
Annual Lump Sum Prepayment Option*	15,900,892	18,523,501	20,641,920	20,207,438
Required Employer Contribution (Percentage of Payroll)				
Employer Normal Cost	20.05%	19.56%	19.07%	20.33%
Unfunded Liab. Contr.	28.68%	32.18%	35.65%	33.74%
Total Employer Rate	48.73%	51.74%	54.72%	54.07%
Employee Contributions				
Employee Contributions	5,413,025	5,669,215	5,767,178	6,158,285
Employee Rate	9.44%	9.52%	9.63%	9.95%

*Beginning FY 2017-18, only the unfunded liability may be prepaid

**Beginning FY 2017-18, only the normal cost is billed as a % of payroll.

Unfunded contribution was converted to % for comparison.

For FY 2023-24, the total County contribution for Miscellaneous Plan will increase by \$4,986,171, a

6.5% increase over the prior fiscal year. The County contribution for Safety Plan over the same fiscal year increases by \$693,159 or 2.1%.

These fluctuations in contribution rates for the County are representative primarily of increased payroll projections and changes in CalPERS methodology. The unfunded liability for both the Miscellaneous and Safety plans decreased about 2% from the prior year, mainly due to favorable investment return based on the 06/30/2021 valuation reports. However, the projected payroll increased 6.7% for Miscellaneous and 3.4% for safety, thereby increasing the Employer Normal Cost. Additionally, CalPERS revised assumptions used to calculate contributions to reflect improved life expectancy among its membership. The improved life expectancy is reflected in the lower active employee to retiree ratio, which has decreased from 2 to 1 over a decade ago to 1.14 to 1 in 2022 and is expected to continue to decrease. A lower number of active employees are paying into the system to support retirees, who are also living longer. Other factors contributing to the increase in unfunded liabilities are new amortization and smoothing policies (discussed below) and change to the discount rate or assumption of return on investment.

Prior to FY 2017-18, the County's contributions were based on a percent of payroll with a portion of the contribution paying down unfunded liabilities. Beginning with FY 2017-18, the portion to pay unfunded liabilities became a fixed dollar amount determined by CalPERS in its actuarial report, rather than a percent of payroll. This ensures payments are not affected by a lower payroll. The "normal cost" which is the contribution on behalf of active employees will remain as a percentage of the annual covered salary.

In December 2016, the CalPERS Board of Administration approved lowering the CalPERS discount rate assumption from 7.5% to 7.0%, to be phased in over three years, beginning with FY 2018-19. This change was due to the volatility of the pension fund caused by weak investment returns in a low interest rate environment. The earnings, or the rate of return realized on investments, pays for nearly two-thirds of benefits paid out. Because realistic earnings are expected to be lower, this change results in higher costs and accrued liabilities, further increasing County contributions. However, by lowering the discount rate, CalPERS is on the path to strengthen the long-term sustainability of the

pension fund, while reducing negative cash flows and volatility.

The CalPERS Funding Risk Mitigation policy allows CalPERS to use investments gains to offset the cost of reducing the volatility of future investment returns. In FY 2020-21, the 21.3% return greatly exceeded the 7.0% discount rate assumption; therefore, the discount rate was lowered to 6.8% in the valuation report to reduce future investment volatility. This mechanism helps offset growth in liability in years where returns are much lower, such as FY 2021-22 which preliminary results reflect a loss of (6.1%) and will impact the next valuation report which will set FY 2024-25 contributions.

In June 2013, CalPERS instituted a new amortization and smoothing policy for determining County contribution rates. Amortization and smoothing are what CalPERS uses to avoid large swings in the rate due to extreme market events. CalPERS stated the changed methodology would: (1) improve funding levels; (2) reduce rate volatility in large investment loss years; (3) improve transparency regarding the timing and impact of future rate changes; and (4) eliminate the need for an actuarial value of assets (future actuarial reports would only provide funded status and unfunded liability). CalPERS also acknowledged that although near term contribution rates would increase due to these changes, long term contribution rates would be lower.¹

Public Employee Pension Reform Act of 2013 (PEPRA)

The California Public Employee Pension Reform Act of 2013 (PEPRA), which went into effect on January 1, 2013, established a cap on the amount of compensation that can be used to calculate the retirement benefits for all *new* CalPERS members. Generally, employees that are primarily affected by PEPRA are those that have never been employed by any public employer prior to January 1, 2013. New miscellaneous members are subject to a formula based on 2% at age 62 (versus the prior 2% at 55 formula discussed above). For new public safety members, the formula changes from 3% at age 50, to 2.7% at age 57. There are some provisions in PEPRA that also affect existing employees, i.e. limit on post-retirement employment, felony convictions, and breaks in service

¹ CalPERS Circular Letter No. 200-019-13, April 26, 2013

and reciprocity. A complete actuarial cost analysis of PEPRA prepared by CalPERS can be found at the following link: <http://www.calpers.ca.gov/page/newsroom/for-the-record/2012/actuarial-analysis>

Unfunded Pension Liabilities

An unfunded pension liability is the difference between the pensions the County is obligated to pay to employees when they retire and the money available to pay for those pensions. CalPERS projects future pension requirements annually for the County and calculates the amount required to meet future pension payments.

Beginning with the June 30, 2013 valuations that set the FY 2015-16 rates, CalPERS no longer uses an actuarial value of assets and has employed an amortization and smoothing policy that pays for all gains and losses over a fixed 30-year period with the increases or decreases in the rate spread applied over a 5-year period. Pursuant to that change, the Market Value of Assets (MVA) is used and not Actuarial Value of Assets (AVA), which means Unfunded Liability is measured on an MVA Basis and not an AVA Basis.

Effective with the June 30, 2019 valuation, a shorter amortization was adopted for future gains and losses, reducing the amortization period from 30 years to 20 years and removing the 5-year ramp up or down on UAL bases.

Table 13 reflects the MVA Basis and shows that the County’s unfunded liability for the Miscellaneous Plan decreased by \$191,344,658 from June 30, 2020 to June 30, 2021. The Safety Plan unfunded liability decreased by \$59,149,290 over the same period. The total unfunded liability for both plans totals \$568,299,509 based on the June 30, 2021 report, a reduction of 30.6% over the previous report. The Miscellaneous and Safety Plans are funded at 85.1% and 73.8%, respectively, and the improvement from the last report is largely attributed to the high investment return for the year.

The amounts provided in Table 13 are based on the previous two years’ data, the latest available.

Table 13

Miscellaneous Plan - Funded Status				
Measure	6/30/2018	6/30/2019	6/30/2020	6/30/2021
Present Value of Projected Benefits	2,388,027,673	2,509,632,113	2,620,501,937	2,885,211,737
Entry Age Normal Accrued Liability	1,952,093,531	2,060,649,621	2,164,127,309	2,341,503,109
Market Value of Assets	1,473,835,523	1,559,410,164	1,622,904,212	1,991,624,670
Unfunded Liability	478,258,008	501,239,457	541,223,097	349,878,439
Funded Ratio	75.5%	75.7%	75.0%	85.1%
Safety Plan - Funded Status				
Measure	6/30/2018	6/30/2019	6/30/2020	6/30/2021
Present Value of Projected Benefits	845,621,723	888,687,270	922,461,790	990,522,420
Entry Age Normal Accrued Liability	706,148,009	746,585,474	781,412,473	834,923,858
Market Value of Assets	459,542,651	485,347,113	503,842,113	616,502,788
Unfunded Liability	246,605,358	261,238,361	277,570,360	218,421,070
Funded Ratio	65.1%	65.0%	64.5%	73.8%

On June 2, 2021, in response to the increasing UAL, the Board of Supervisor established a Section 115 Pension Trust with the Public Agency Retirement Services (PARS). The 115 Pension Trust, pursuant to IRS Code Section 115 utilizes an investment similar to CalPERS designed to provide annualized returns of 4-6% with funds held in the trust only available to fund future pension liabilities. The initial investment for the 115 Pension Trust was funded by \$8,038,138 from the General Fund Compensated Absence Assignment. Also, as part of the year-end process in FY 2020-21, the Board set aside one-time funding additions to the 115 Pension Trust in the amount of \$40,628,394. This included a General Fund contribution of \$30,641,609, and reconciled balance in the UAL-PERS Unfunded Liability sub-BSA (2103) held in the Payroll Revolving Fund 543 of \$6,462,039 and from Natividad \$3,524,746.

To assure ongoing oversight the Board has adopted a Pension Liability Policy. The County will follow the Pension Liability Policy by making ongoing contributions through annual departmental charges. In FY 2023-24, the annual contribution will be \$15,227,703

Other Post-Employment Benefits (OPEB)

Governmental Accounting Standards Board Statement Number 45 (GASB 45) requires public agencies to account for and report the Annual Required Contribution (ARC) of Other Post-Employment Benefits (OPEB) on financial statements. OPEB are

those benefits defined as post-retirement medical, pharmacy, dental, vision, life, long-term disability, and long-term care benefits that are not associated with a pension plan.

Prior to 2009, the County paid OPEB benefits as they came due. The California Employer’s Retiree Benefit Trust (CERBT) was established by CalPERS in 2007 at the request of public employers to provide a low-cost, professionally managed investment vehicle for prefunding retiree health benefits and other post-employment benefits. The County makes regular contributions to CERBT where the funds are professionally invested like the CalPERS retirement funds. The expected rate of return used to determine OPEB liability is 6.75%. The County can then utilize funds from the trust to pay OPEB costs.

To participate in the CERBT, CalPERS requires a funding policy. The County contributes an amount at least equal to 100% of the current year cost of the ARC as specified in the applicable actuarial valuation.

Table 14 below reflects actuarial valuations in the County’s net OPEB liability. Information on this table is based on the most recent report for the period ending June 30, 2022.

Table 14

OPEB Obligations and Asset Valuation				
	FY 2018-19	FY 2019-20	FY 2020-21	FY 2021-22
Total OPEB Liab.	72,800,654	80,466,905	86,841,264	95,870,517
Plan Fiduciary Net Position	34,017,783	40,764,288	47,753,003	66,600,276
Net OPEB Liability (NOL)	38,782,871	39,702,617	39,088,261	29,270,241

Table 14 shows both the County’s Total OPEB Liability (formally the Actuarial Accrued Liability) and the County’s Plan Fiduciary Net Position (formally referred to as the Market Value of Assets) increased by \$9,029,253 and \$18,847,273 respectively. Accordingly, the Net OPEB Liability decreased by \$9,818,020 compared to the previous year. The improvement was primarily due to strong investment performance, which is not expected to continue. OPEB liability, just like pension liability can be greatly impacted by investment performance, where investment gains can improve the liability, while investment losses will typically grow liability. Actuarial valuations from which the data on table 14 derives, are prepared every two years.

However, most recent data based on the CERTB quarterly statement report for the period ending June 30, 2022 indicates the County’s fiduciary net position decreased from \$66,608,882 to \$61,246,602 in FY 2021-22. This change was the result of County contributions to the plan in the amount of \$4,603,000, investment loss of \$9,314,385, and a transfer out of \$594,167 of Water Resources Agency’ funds to establish their own account. This represents decrease of \$5,362,280 over the previous period. Table 15 below shows the ending balance for the las four fiscal years based on the CERBT Annual Statements. Information on this table is different than the actuarial reports as the actuarial reports are only updated every two years.

Table 15

California Employers' Retiree Benefit Trust (CERBT)				
	FY 2018-19	FY 2019-20	FY 2020-21	FY 2021-22
Beginning Balance	34,037,328	40,778,339	47,769,148	66,608,882
Contribution	4,621,000	5,584,875	5,188,000	4,603,000
Investment Earnings	2,149,133	1,442,493	13,700,429	(9,314,385)
Transfer Out	-	-	-	(594,167)
Admin. Expenses	(16,822)	(21,118)	(28,140)	(32,769)
Investment Expenses	(12,300)	(15,441)	(20,555)	(23,960)
Ending Balance	40,778,339	47,769,148	66,608,882	61,246,602

Workers’ Compensation and General Liability

Workers’ Compensation

The County accounts for its Workers’ Compensation and General Liability risk financing activities in two internal service funds (ISFs) functioning as the County’s self-insurance programs. ISFs are used to separately budget and account for services provided to County departments. Workers’ Compensation is administered by Risk Management which is part of the Office of County Counsel. For specific information on the Workers’ Compensation ISF, see the detail contained in County Counsel’s Budget Unit 8409 description.

Workers' Compensation is a form of insurance the County utilizes to provide compensation and medical care for employees who are injured during employment. Workers’ Compensation provides for payments in place of wages (functioning as a form of disability insurance), compensation for economic loss (past and future), reimbursement or payment of medical and like expenses (functioning as a form of health insurance) and benefits payable to the dependents of workers killed during employment (functioning as a form of life insurance). General

Contributions/Obligations, Liabilities and Other

damages for pain and suffering and punitive damages for employer negligence are generally not available in workers' compensation plans.

Workers' compensation is administered on a state-by-state basis, with a state governing board overseeing varying public/private combinations of workers' compensation systems. In most states, workers' compensation is solely provided by private insurance companies. Twelve states operate a state fund of which California is the largest. The California Constitution, Article XIV Section 4, sets forth the intent of the people to establish a system of workers' compensation. It provides the Legislature with the power to create and enforce a complete system of workers' compensation and, likewise, create and enforce a liability on the part of any or all employers to compensate any or all their employees for injury or disability. This liability includes employees' dependents in the case of an employee's death in the course of their employment, irrespective of the fault of any employee.

Since 1973, the County has been self-insured for Workers' Compensation liabilities. The County utilizes a third-party claims administrator Intercare Holdings to assist with claims management, reporting, and data management. Most recently the agreement was reauthorized on June 24, 2020.

Unpaid claims liabilities are based on the results of actuarial studies and include amounts for claims incurred but not reported, and adjustment expenses. Claims liabilities are calculated considering the effects of inflation, recent claim settlement trends including frequency and amount of payouts, and other economic and social factors. Workers' Compensation liabilities are carried at present value using a discount rate of 2.5%. Premiums are charged by the ISFs using various allocation methods that include actual costs, trends in claims experience, and number of participants.

Historically, the County's Annual Comprehensive Annual Financial Report (ACFR) has been used to report the Workers' Compensation ISF net position. Commencing in FY 2015-16 the Actuarial review of the County's Self-Insured Workers' Compensation Program is used.

Bickmore's October 2022 review estimates the cost of claims and expenses for claims incurred during the FY 2022-23 and FY 2023-24 program years to be \$18,222,000 and \$19,560,000, respectively. These

amounts include: Allocated Loss Adjustment Expenses (ALAE) (direct cost associated with the defense of individual claims such as legal and investigation fees and court charges); Unallocated Loss Adjustment Expenses (ULAE) (cost to administer all claims to final settlement, which may be years in the future, such as claims adjusters' salaries and taxes); and a discount for anticipated investment income (based on the likely payout pattern of the County's claims, assuming a 2.5% return on investments per year). The expected FY 2022-23 and FY 2023-24 costs translate to rates of \$3.79 and \$3.95 per \$100 of payroll, respectively.

Bickmore estimates the program's liability for outstanding claims to be \$89,488,000 and \$92,957,000 as of June 30, 2022 and June 30, 2023, respectively. As of June 30, 2022, the estimated program assets of \$99,278,000 render the program funded above the 70% confidence levels, projecting a surplus of \$3,156,000 at June 30, 2023.

The Board of Supervisors approved a 10-year plan to fund the program deficit in FY 2004-05. Prior to the Board's plan, the County was on a pay-as-you-go basis which caused deficits in the fund. In FY 2010-11, due to budget constraints, the County postponed the deficit funding plan; however, the County has since reinstated the funding plan. Bickmore recommends a five-year funding plan to maintain program assets at the 70% confidence level by June 30, 2028. Under this plan, Bickmore recommends amortizing the surplus over five years with the County funding the value of each prospective year's claims costs offset by the amortized projected surplus as of June 30, 2023. To maintain funding at the 70% confidence level, the County's FY 2023-24 contribution is \$26,000,000 made up of \$21,301,000 for claims and loss adjustment expenses, \$5,362,000 for non-claims related expenses, and a \$663,000 reduction from the June 30, 2023 projected surplus.

General Liability

General Liability insurance is part of the County's general insurance system of risk financing for the risks of liabilities imposed by lawsuits and similar claims. Liability judgments, settlements, and claims against the County are paid from the General Liability ISF.

Similar to Workers' Compensation, the County's ACFR had been used to report the General Liability

ISF net position. Commencing in FY 2015-16 the Bickmore actuarial review of the County's Self-Insured General Liability Program is used.

The October 27, 2022 review estimated the cost of claims and expenses for claims during the FY 2022-23 and FY 2023-24 program years to be \$8,845,000 and \$9,539,000, respectively. These amounts include ALAE, ULAE and a discount for anticipated investment income (based on the likely payout pattern of the County's claims, assuming a 2.5% return on investments per year). The expected costs for FY 2022-23 and FY 2023-24 claims translate to rates of \$1.84 and \$1.93 per \$100 of payroll, respectively.

Bickmore estimates the program's liability for outstanding claims to be \$18,442,000 and \$21,781,000 as of June 30, 2022 and June 30, 2023, respectively. As of June 30, 2022, the estimated program assets total \$24,470,000, indicating the program is funded between the 80% and 85% confidence level. There is a projected surplus of \$4,126,000 at June 30, 2023 based on the 70% confidence level.

Bickmore recommends the County implement a five-year funding plan to bring program assets back to the desired Marginally Acceptable 70% confidence level by June 30, 2028. Under this plan, Bickmore recommends amortizing the surplus over five years; with the County funding the value of each prospective year's claims costs offset by the amortized projected surplus as of June 30, 2023. Based on this recommendation, the County's FY 2023-24 contribution is \$18,264,000 made up of \$11,200,000 for claims and loss adjustment expenses, \$7,930,000 for non-claims related expenses, and a reduction of \$866,000 from the June 30, 2023 surplus.

The County settled for a \$15,500,000 Notes Payable in FY 2007-08 from its Lakes Resort which caused the deficit in the fund. According to the FY 2010-11 ACFR (Note to Financial Statements #23) the Note amount with interest was approved to be paid in full by the County Board over 15 years; however, the fund experienced a deficit five years previously when the County was on a pay-as-you-go basis. The balance on the notes payable from the Lakes Resort is \$1,350,992 as of June 30, 2022 and matures June 2024.

Vacation Accruals

Employee's unused vacation and paid time off (PTO) may be accumulated up to a specified cap depending on the employee's bargaining unit. When an employee

separates from County employment, they are paid any unused vacation and PTO balances. Because the County cannot accurately predict when an employee may separate, the liability of compensated absences that could potentially be paid during a fiscal year is a dynamic figure.

Table 16 shows the net vacation accrual/compensated absences liability on June 30 of the past four fiscal years as reported in the ACFR. The vacation accrual liability for fiscal year ending June 30, 2022 is \$49,814,417. In FY 2010-11, a reserve to meet vacation accrual/compensated absences payouts was created. As part of the FY 2020-21 year-end process, the Board replenished the Compensated Absences Assignment by \$9,527,138 to continue to keep reserves for employee vacation accruals. Therefore, the total compensated absences liability is \$40,287,279, a decrease of \$7,788,277 from the prior year.

Table 16

Compensated Absences				
	FY 2018-19	FY 2019-20	FY 2020-21	FY 2021-22
Unfunded Liability	39,691,011	43,254,238	48,075,556	49,814,417
Reserve	8,038,138	8,038,138	-	9,527,138
Total Compensated Absences Accrual	31,652,873	35,216,100	48,075,556	40,287,279

Debt

In July 2017, the Board of Supervisors revised the County's Debt Management Policy's debt issuance approval process for non-capital improvement projects (non-recurring, less than \$100,000, and/or useful life of less than five years). Rules contained in the Debt Management Policy include the General Obligation bond debt ceiling of 1.25% of the countywide assessed value (including Certificates of Participation), limitations and procedures for investment of debt proceeds, and terms of use of Mello-Roos financing.

Certificates of Participation (COPs) provide long-term financing where an individual purchases a share of the lease revenues of an agreement made by a government entity. These purchases are made through a lease or installment sale agreement that does not constitute indebtedness under the State constitutional debt limitation. COPs differ from bonds in that they are not subject to statutory restrictions applicable to bonds, including interest rate limitation, election requirements, competitive sale requirements, or semiannual or fixed rate interest payment restrictions.

A summary of the County’s long-term debt obligations over the past four fiscal years is shown in Table 17.

Table 17

County Long-term Debt Obligations				
Description	FY 2020-21	FY 2021-22	FY 2022-23	FY 2023-24
COPs	107,816,404	102,703,609	97,341,192	92,204,445
COP NGEN	2,363,792	1,606,182	818,645	-
Capital Leases / Notes	40,604,291	38,155,376	35,552,368	32,862,475
NMC COP's / Leases	29,073,594	25,431,389	21,613,806	17,610,555
Liabilities	179,858,081	167,896,556	155,326,011	142,677,475

Certificates of Participation originally issued for the construction of the current Natividad Medical Center (NMC) campus were refunded in December 2019 due to favorable interest rate conditions, lowering the debt service for the COPs.

NGEN is in response to a Federal Communications Commission mandate requiring wideband radio users to migrate to narrow band modes. The financing obligations are shared by multiple agencies participating in the public safety radio network project. Those agencies obligations are secured by the jurisdictions’ property taxes. This note is expected to be paid off in FY 2023-24.

In July 2017, the County refunded (refinanced) its 2007 COPs that were issued to finance portions of the costs of renovating, constructing, acquiring, and improving County infrastructure including Health facilities. The refunding of the 2007 COPs and issuance of the 2017 COPs resulted in over \$2 million in annual savings due to favorable market conditions. Interest payments for the 2017 Refunding COPs (both County portion and NMC) are paid twice annually in October and April.

The acquisition of the Schilling Property during FY 2014-15 poised the County to begin the process of optimizing usage of County facilities while incorporating plans to reuse unoccupied County facilities. Several projects were combined: (1) the 1441 Schilling Place Tenant Improvement Project with the Administration Building Tenant Improvement Project; (2) the East and West Wing Tennant Improvement Project; and (3) the Government Center Modular Removal Project all combined into one master project package plan, the Monterey County Facilities Utilization Project. The combined projects were budgeted and scheduled under the Monterey County Facilities Utilization Project, which provided oversight to enhance long term infrastructure and centralization efficiencies while balancing facility space needs at 1441

Schilling Place, the Administration Building, the East and West Wings, and eliminating the need for modular buildings.

Table 18 reflects the historical and future repayment schedule for the County’s COPs, NMC COPs, and the County financing of the Next Generation Radio Project (NGEN).

Table 18

Annual Debt Service					
Debt	Payment Due	FY 2020-21	FY 2021-22	FY 2022-23	FY 2023-24
2017 Refunding COP - NMC	October	\$86,404	\$81,313	\$75,883	\$70,194
	Principal	\$203,614	\$217,205	\$227,583	\$213,251
	April	\$81,313	\$75,883	\$70,194	\$64,862
Total		\$371,331	\$374,401	\$373,660	\$348,307
2017 Refunding COP - County	October	\$1,661,921	\$1,564,012	\$1,459,567	\$1,350,131
	Principal	\$3,916,386	\$4,177,795	\$4,377,417	\$4,101,749
	April	\$1,564,012	\$1,459,567	\$1,350,131	\$1,247,588
Total		\$7,142,319	\$7,201,374	\$7,187,115	\$6,699,468
2019 NMC Refunding COPs	October	\$725,125	\$644,375	\$558,750	\$469,000
	Principal	\$3,230,000	\$3,425,000	\$3,590,000	\$3,790,000
	April	\$644,375	\$558,750	\$469,000	\$374,250
Total		\$4,599,500	\$4,628,125	\$4,617,750	\$4,633,250
2015 COP	October	\$1,030,447	\$1,008,197	\$984,822	\$960,197
	Principal	\$890,000	\$935,000	\$985,000	\$1,035,000
	April	\$1,008,197	\$984,822	\$960,197	\$934,322
Total		\$2,928,644	\$2,928,019	\$2,930,019	\$2,929,519
NGEN County Portion *		\$282,682	\$282,682	\$282,682	\$230,355
Total County Annual Debt Service		\$15,324,476	\$15,414,601	\$15,391,226	\$14,840,899

*NGEN obligation changes annually based on Emergency Communication’s calculation as to each MOU participant’s obligation.

Other Obligations

Williamson Act

Monterey County’s leading industry and foundation for economic development is agricultural production and distribution. The California Land Conservation Act of 1965, otherwise known as the Williamson Act, was enacted to preserve agricultural and open space lands by discouraging conversion to urban uses.

The Williamson Act allows private landowners to contract with counties to voluntarily restrict land uses. Landowners are given property tax relief in exchange for an agreement that the land will not be developed or converted to another use, thus preserving agricultural and open space land. The Williamson Act provided an annual State-provided subvention to local

governments to compensate for the tax loss. However, revisions to the California State budget in July 2009 eliminated the subventions while providing the opportunity for counties to opt out of the contracts.

Table 19 shows the calculated tax loss associated with Williamson Act contracts in FY 2021-22 to be \$1,434,923 from approximately 677 active contracts. The estimated portion of County tax loss is the overall tax revenue (calculated at 1% of assessed valuation) and the County's actual tax loss (approximately 14%). The estimated tax loss is based on the average tax the County receives on both incorporated and unincorporated areas. Fiscal Years 2022-23 and FY 2023-24 are estimated using the Assessor's county-wide projected property tax growth rates of 6.25% each year. Based on these assumptions, the estimated tax loss for FY 2023-24 is \$1,619,894. Every year, the County reviews applications under the Williamson Act, and if approved, landowners receive tax relief effective the following year. The number of contracts is estimated to increase by about eight contracts each year based on historical information.

Table 19

Williamson Act Contracts Estimated County Tax Loss				
Description	FY 2020-21	FY 2021-22	FY 2022-23	FY 2023-24
Total Contracts	671	677	685	693
Base Value	2,792,157,145	2,961,764,396	3,146,874,671	3,343,554,338
Base Value Enrolled	518,380,444	578,837,235	615,014,562	653,452,972
WA - Assessed Value	2,471,316,355	2,648,798,058	2,814,347,937	2,990,244,683
WA - Enrolled Value	1,299,375,327	1,357,982,008	1,442,855,884	1,533,034,376
WA - Net Value Loss	974,401,374	1,024,945,153	1,089,004,225	1,157,066,989
Net Tax Loss	9,744,014	10,249,452	10,890,042	11,570,670
County Portion of Tax Loss	1,364,162	1,434,923	1,524,606	1,619,894

Shaded areas are estimates

GFC Contributions to the Library Fund (003)

The County has historically supplemented the Library Fund with General Fund Contributions. This figure had remained relatively constant until FY 2017-18. On December 12th, 2017, the Board of Supervisors authorized the General Fund allocation of the full salary and benefits of the Library Director pursuant to State law (California Education Code Article 2, Section 19147). The FY 2023-24 General Fund contribution to the Library Fund is budgeted at \$283,889. Table 20 provides a four-year history of contributions.

Table 20

Contribution to Library				
	FY 2020-21	FY 2021-22	FY 2022-23	FY 2023-24
GFC	249,320	262,025	275,356	283,889

TOT Contribution to the Road Fund (002)

Prior to FY 2013-14, the Road Fund received \$2,000,000 annually in Transient Occupancy Tax (TOT). In February 2014, recognizing that well-maintained roads contribute to economic vitality, the Board of Supervisors approved the following percentage formula providing an annual increase to eventually lead to a TOT rate capitation of 25%: FY 2013-14 (20%), FY 2014-15 (21%), FY 2015-16 (22%), FY 2016-17 (23%), FY 2017-18 (24%) and FY 2018-19 (25%). The percent of TOT contributions to the Road Fund was based on the two-year's prior audited TOT numbers contained in the ACFR. Effective with the FY 2019-20 adopted budget, the Board of Supervisors continued the contribution to the Road Fund based on the established formula, however, only the Maintenance of Effort (MOE) amount of \$5,319,831 was transferred to the Road Fund, with the remaining amount of \$920,053 set aside for priority projects.

Considering significant reductions anticipated in TOT due to the pandemic, the County moved toward contributing the MOE amount toward the Road Fund, rather than the existing formula. Effective with FY 2020-21, the contribution of \$5,205,660 is based on the MOE using FY 2016-17 as a base year and increasing each year by a construction inflation index two years in arrears. Using this same formula, the contribution for FY 2023-24 amounts to \$6,222,054, which is an increase of \$412,480 or 7.1% higher than the prior year. Table 21 provides six years of past and future TOT contributions to the Road Fund.

Table 21

TOT Contributions to Road Fund		
FY	% of TOT	Amount
2018-19	25%	\$ 5,319,831
2019-20	25%	\$ 6,239,884
2020-21		\$ 5,205,660
2021-22		\$ 5,486,766
2022-23		\$ 5,809,574
2023-24		\$ 6,222,054

Pajaro /Sunny Mesa Community Services District

In FY 2015-16, the Board of Supervisors approved a Memorandum of Understanding (MOU) with the Pajaro/Sunny Mesa Community Services District to annually allocate \$25,000 for the maintenance of the Pajaro Neighborhood Park. The MOU is in effect until June 30, 2039.

Healthcare Realignment

Pursuant to Welfare and Institutions Code Section 17000, California counties are required to provide medical care to indigent residents lawfully residing in the County when such persons are not supported and relieved by some other means. Historically, this population of medically indigent adults (MIAs) had been cared for by county governments that relied on local, State and federal funding to provide the necessary services. Until recently, the County received funding for this purpose via the “realignment” of health and social services programs that occurred in 1991 and 1992. Realignment increased California sales and vehicle license fees to earmark for counties to support the financial obligations of caring for the MIA population, amongst other things.

When California elected to implement a State-run Medicaid Expansion under the Affordable Care Act, the State anticipated that counties’ costs and responsibilities for the medically indigent would decrease since many in this population would become eligible for coverage through Medi-Cal or the Exchange, where Californians can get brand-name health insurance with federal premium assistance. On June 27, 2013, Governor Brown signed into law Assembly Bill 85 (AB 85) that provided a mechanism for the State to redirect State Health Realignment funding to fund social service programs.

In consideration of the Medi-Cal expansion for MIA adults, effective January 1, 2014 AB 85, as modified by Senate Bill 98, reduced California counties’ Health Realignment funds by an average of 60% (including maintenance of effort payments). Beginning in FY 2014-15, a portion of California counties’ realignment amounts, based upon a calculation of Fiscal Years 2009 through 2012, would be subject to redirection by the State. Table 22 provides the amount of realignment dollars the County received for the fiscal periods utilized to determine the redirected amounts.

Table 22

Monterey County Realignment Dollars Received by Fiscal Year			
Fiscal Year	Sales Tax Realignment	Vehicle License Fees	Total Realignment Dollars
2008-09	\$ 2,709,949	\$ 8,759,851	\$ 11,469,800
2009-10	\$ 2,609,952	\$ 8,169,943	\$ 10,779,895
2010-11	\$ 2,609,952	\$ 8,169,943	\$ 10,779,895
2011-12	\$ 2,609,952	\$ 7,583,086	\$ 10,193,038

Public hospital counties were given a choice between two options to determine the pro rata portion of realignment funds. Because Natividad Medical Center is the designated county hospital for Monterey County, the AB 85 options were: 1) Percentage approach: accept a reduction of 60% in realignment funds, including \$3.3 million in annual maintenance of effort payments (percentage approach); or 2) Formula approach: utilize a formula to show a lesser reduction would be appropriate. The second option was based on historical costs for providing uninsured programs.

The Board of Supervisors chose the formula approach and Natividad Medical Center and the Health Department provided historical data to the State’s Department of Health Care Services (DHCS) to use in determining the reduction formula. Initially, the State returned a formula that would have resulted in an 85% reduction of health realignment funds (approximately \$8.5 million). The Assistant County Administrative Office (ACAO) of the Budget and Analysis Division submitted a subsequent series of historical documentation to the State for re-evaluating the formula. The second submission resulted in a redetermination by the State placing only 51.19% of Monterey County’s realignment dollars at risk for redirection (approximately \$5.1 million).

The redirection is based on a calculation of estimated revenue and expenditures, with an annual “true-up” adjusting for actuals. The County received notification in the beginning of FY 2017-18 that the redirection would increase sharply starting in FY 2017-18, with a nearly \$6 million budget gap emerging in FY 2018-19 as a result. A three-year plan was implemented and includes utilizing \$3.2 million in health realignment fund balance for program costs for animal, children’s medical, communicable disease, home visitation, administrative, public health lab, Whole Person Care (WPC), and Women, Infant, and Children services. Through prudent decision-making and management, the three-year plan has outperformed initial estimates and consequently, realignment fund balance continues

to be used strategically to minimize impacts to services. The department will continue to fund programs with realignment and monitor for any anticipated deficits due to AB 85.

Conclusion

The General Fund supports basic governmental functions including public safety, criminal justice, land use and environment, education, recreation, health and sanitation, public assistance, and finance and administration.

As the demands on the County’s funds increase via obligations, liabilities and contributions, the ability to maintain the service levels of prior fiscal years becomes more challenging. County departments continue to exercise austere fiscal measures in day-to-day operations but will undoubtedly face future challenges in upcoming fiscal years.



This page intentionally left blank.

Capital Budget Summary

Capital Improvement Program (CIP)

Five-Year Plan

Fiscal Year (FY) 2023-24 through 2027-28

The County of Monterey Capital Improvement Program Five-Year Plan (hereinafter CIP) sets forth capital projects essential to maintain and improve County public facilities and facilitates the orderly implementation of the County General Plan. Public facilities include buildings, major equipment, telecommunications infrastructure, parks, and transportation systems. CIP projects are those projects that cost more than \$100,000 and provide long-term assets to Monterey County.

Each year, the CIP is updated and reviewed considering County needs, priorities, and available funding. A long-term CIP provides several benefits:

- Prioritizes needs and establishes an orderly basis for sound budgetary decisions.
- Focuses attention on both mandated and community goals, needs, and capabilities for best use of public funds and establishes a long-term plan to address future needs.
- Improves the likelihood of obtaining State and federal financing assistance for projects.
- Encourages project coordination between the County and public agencies which serves to reduce scheduling conflicts.
- Permits private enterprise to relate and/or align their projects to the CIP.

The CIP five-year plan is developed annually as part of the County budget process. Capital projects are administered by the Public Works, Facilities & Parks Department (PWFP), Natividad Medical Center (NMC), and Information Technology Department (ITD). PWFP leads in developing the CIP and coordinates with County departments to identify, compile and document the capital needs of the County agency.

Capital needs for County infrastructure, such as roads, bridges, buildings, and parks total nearly \$1.6 billion, which far exceeds available financing resources. As such, priorities must be established and revised as new funding streams become available and the County capital needs are modified. The unfunded and partially funded Projects proposed for FY 2023-24 are ranked utilizing two methodologies: 1) life/health/safety criteria and 2) racial equity tool criteria. The Projects and costs identified for FYs 2024-25 through 2027-28 illustrate priorities and magnitude of future funding needed.

PWFP presents the draft CIP to the Capital Improvement Committee (CIC) for project priority determination. These recommendations are presented to the Board of Supervisors at the April Budget Workshop. The County Administrative Office Budget & Analysis Division will use the recommendations from the CIC and the Board comments at the Budget Workshop to incorporate project funding (as available) into the

Recommended Budget. The Recommended Budget and capital projects will be presented to the Budget Committee (BC) in May 2023 for fiscal review. The CIP is presented to the Planning Commission to determine conformity with the General Plan. The final CIP is presented to the Board of Supervisors in June for consideration as part of the annual budget adoption process.

Capital Projects are budgeted in Capital Projects, Fund 404. Adoption of the CIP budget appropriates funding for the first year of the five-year program as part of the operating budget. The total capital budget for projects requested countywide, which include funded, partially funded, or unfunded, in FY 2023-24 is \$811 million. Budgeted costs include design, environmental, construction, equipment, land purchase, and project administration of new, improved, or replacement infrastructure. Funding for CIP is provided through a wide variety of sources, including local, State and federal grants, gas tax revenues, bonds, fees, and capital funds.

The current CIP projects list includes 93 projects funded in FY 2023-24. The CIP also includes a list of future funded and unfunded needs which County departments have identified as a priority. This future project list is comprised of 67 projects with a total estimated amount of \$647 million.

The Capital Projects Fund 404 accounts for financial resources used for the acquisition or construction of major capital assets. These include land and land improvements, buildings and building improvements, infrastructure, and construction in progress. The

Fund 404: PWFP Capital Projects

FY 2023-24 Recommended Budget for Fund 404 PWFP includes the following:

Project Title	Project Budget FY 2023-24
911 Center Replace 2 HVAC units	434,919
Ag Department - South County Facility	697,908
Animal Shelter Replace HVAC unit	1,946,754
ARPA Project Contingency	765,081
Behavioral Health East Salinas Center	1,885,336
Capital Improvement Project Administration	225,000
Carmel River Floodplain Restoration (CRFREE)	8,597,562
Carmel Lagoon	30,000
CSA/CSD - ARPA Projects	514,954
Development SW Corner of Gabilan @ Church	334,674
Health Department - Water Intrusion Project	2,781,078
Jail Housing Addition - Lift Station	555,500
Laguna Seca Clean Water - ARPA	450,002
Laguna Seca Wastewater - ARPA	1,324,277
Parks - ARPA Projects	3,332,132
Prop 68 Per Capita Grant	369,288
San Ardo Yard - New Modular	490,005
Sheriff Multiple Projects	880,068
Fund 404 Total:	25,614,538

911 Center Replace 2 HVAC Units:

Two of the four compressors and one low-pressure switch in the two rooftop HVAC units failed at the 911 facility located at 1322 Natividad Road. The HVAC units are 19 years old with a life expectancy of 20 years. Replacement parts are obsolete and the refrigerant in the units is outlawed in new HVAC units in California making it difficult to obtain. This project will replace the two HVAC units, ensuring the data center can operate as required to sustain the critical services provided by the building occupants and the other departments who utilize the data center at the facility.

Total FY 2023-24 Budget: \$434,919
Total Project Budget: \$453,792
Est. Project Completion Date: 6/30/2024

Ag Department – South County Facility:

Develop Agricultural Commissioner (AC) newly purchased facility to meet AC South County operational needs. The new facilities will consist of approximately 5,000 square feet of offices, a conference room, and supplies and equipment storage. The AC completed the Board approved purchase of the 1011 Broadway Street location in November 2021 for \$1.8 million. This project is ongoing and partially funded. Previously listed in CIP as Project #2017-SC.

Total FY 2023-24 Budget: \$697,908
Total Project Budget: \$4,236,943
Est. Project Completion Date: 6/30/2025

Animal Shelter Replace HVAC Units:

The Animal Services facility at 160 Hitchcock Road is approximately 22 years old. The existing HVAC system is the original equipment and is comprised of seven HVAC units. Five units are over the main building where the customer service area, staff offices, spay and neuter clinic, and animal housing are located. The other two units are over the dog kennel wings. Due to the age of the equipment, the need for repairs has increased significantly over the past few years and the units are quickly reaching a point where they may no longer be repairable. This project will replace the old HVAC system with a new HVAC system to ensure consistent and efficient heating/cooling needs for the animals and people that are in the building.

Total FY 2023-24 Budget: \$1,946,754
Total Project Budget: \$2,246,754
Est. Project Completion Date: 6/30/2024

ARPA Project Contingency:

The American Rescue Plan Act (ARPA) Project Contingencies for County Service Areas (CSA), County Sanitation Districts (CSD) and Parks water and sewer infrastructure projects per the ARPA water and sewer infrastructure allocation plan.

Total FY 2023-24 Budget: \$765,081
Total Project Budget: \$776,386
Est. Project Completion Date: 6/30/2024

Behavioral Health East Salinas Center:

New construction of an approximately 18,000 square foot, two-story building at 331 Sanborn Street in Salinas. This will have approximately 45 treatment/interview rooms and 16 other related rooms. Behavioral Health is short approximately 60 workstations and interview rooms due to growing service demand. Currently no Behavioral Health Services are in East Salinas. It is an underserved area that is impacted by lack of walk-in service locations.

Total FY 2023-24 Budget: \$1,885,336
Total Project Budget: \$23,700,000
Est. Project Completion Date: 6/30/2024

Capital Improvement Project Administration:

This project funds investigative reviews and analysis of potential projects and special requests initiated by the County Administrative Office or Board of Supervisors. It also funds the annual update to the CIP five-year plan.

Total FY 2023-24 Budget: \$225,000
Total Project Budget: \$225,000
Est. Project Completion Date: 6/30/2024

Carmel River Floodplain Restoration and Environmental Enhancement (CRFREE):

The Carmel River Floodplain Restoration and Environmental Enhancement (CRFREE) Project is a comprehensive effort to improve flood control and restore native riparian habitat, floodplain habitat, and hydrologic function to a portion of the lower floodplain along the Carmel River. Key aspects of the project include: 1) Create notches in the levees along the south bank of the lower Carmel River, 2) Restore the south lower Carmel River floodplain, and 3) Build a causeway under Highway 1, connecting the south lower Carmel River Floodplain with the south arm of the Carmel Lagoon. This project is funded through the following grant programs: Wildlife Conservation Board, National Fish and Wildlife Foundation, Department of Water Resources Flood Corridor, Coaster Flood and Urban Streams grant programs, California State Coastal Conservancy, and FEMA/Cal OES Hazard Mitigation Program.

Total FY 2023-24 Budget: \$8,597,562
Total Project Budget: \$56,346,672
Est. Project Completion Date: 6/30/2028

Carmel Lagoon – Scenic Road Protection Structure Project:

The Carmel Lagoon Scenic Road Protection Structure (SRPS)/Ecosystem Protective Barrier (EPB) Project is a multi-objective, multiyear, multi-organizational effort to improve natural floodplain function and protect public infrastructure while maintaining or improving flood risk protection to existing developed areas. The project involves implementing three project components: 1) Ecosystem Protective Barrier; 2) Scenic Road Protection Structure; and 3) Interim Sandbar Management Plan.

Total FY 2023-24 Budget: \$30,000

Total Project Budget: \$21,415,320
Est. Project Completion Date: 6/30/2027

CSA/CSD – ARPA Projects:

ARPA funds will be utilized for sewer and water infrastructure for various County Service Areas (CSA) and County Sanitation Districts (CSD). Several of the CSA/CSD locations are in disadvantaged communities. Over time the ability of these areas to fund the ongoing sewer and water needs has been a challenge. These funds will go to infrastructure repairs in five different CSA/CSD areas, including Pajaro, Boronda, San Jerardo CSDs, and the Chualar CSA. Many of the CSA/CSD water and sewer systems are old and urgently need replacement. Setting aside ARPA funding for water and sewer systems will allow the County to provide residents with drinking water and more reliable sanitation systems and facilities.

Total FY 2023-24 Budget: \$514,954
Total Project Budget: \$4,100,000
Est. Project Completion Date: 6/30/2024

Development of County Property – Church and Gabilan Streets:

This project is located on the former site of the County modulars at the corner of Church and Gabilan in Salinas. The project is to construct a parking structure for City, County, and Court employees and the public. This project would be funded jointly between the City of Salinas and the County of Monterey. This project addresses a significant deficit of off-street parking identified in the original EIR for the Government Center campus.

Total FY 2023-24 Budget: \$334,674
Total Project Budget: \$27,513,690
Est. Project Completion Date: 6/30/2025

Health Department – Water Intrusion Project:

The project involves repairs to address ongoing water intrusion issues during heavy rains. The Health Department at 1270 Natividad Road was commissioned in October 2009. This building serves as the headquarters of the County of Monterey Health Department and houses over 200 county employees. On December 2, 2019, heavy rains penetrated through the stucco walls into the interior. This caused a significant displacement of staff and an emergency response to dehumidify the building in several areas to improve health and safety.

Total FY 2023-24 Budget: \$2,781,078
Total Project Budget: \$3,151,000
Est. Project Completion Date: 6/30/2024

Jail Housing Addition – Lift Station:

This project includes installing a backup system or a bypass to the Jail Housing Addition lift station, pending the final architect design recommendations. Before the Jail Housing Addition project, there was a bypass sewer line connecting the Jail to the NMC sewer system. This connection delayed sewer system backup and gave Facilities time to resolve issues or begin backup pumping. The original construction plans for the Jail

Housing Addition capped this connection to NMC, effectively increasing the potential risk of sewage backup into the Jail if the lift station fails. The increase in inmate population because of the Jail Housing Addition will also impact the rate at which the system could potentially overflow.

Total FY 2023-24 Budget: \$555,500
Total Project Budget: \$800,000
Est. Project Completion Date: 6/30/2024

Laguna Seca Clean Water – ARPA:

Design and implement a water filtration system for the domestic water well at Laguna Seca Recreation Area (LSRA) and upgrade the drinking water distribution system to meet current regulations. Significant upgrades are required by regulators to the drinking water distribution system at LSRA. Upgrades including backflow prevention, storage system automation, and cross connection prevention are needed. This system feeds the entire facility. Failure or significant restrictions to the water distribution system and/or supply can potentially shut down the racetrack and park facilities. The project is required by the County of Monterey Environmental Health Bureau to comply with federally mandated arsenic levels.

Total FY 2023-24 Budget: \$450,002
Total Project Budget: \$1,905,000
Est. Project Completion Date: 6/30/2024

Laguna Seca Wastewater - ARPA:

The project requires a comprehensive inventory and evaluation of seven existing independent sanitary sewer systems with the goal of developing a single system (on-site sewage treatment plant). The existing systems were developed at different times over the years and have varying capacities and related concerns. It would not be financially feasible to address each system individually.

Total FY 2023-24 Budget: \$1,324,277
Total Project Budget: \$1,450,000
Est. Project Completion Date: 6/30/2024

Parks - ARPA Projects:

This project designates a portion of the County ARPA funding to water and sewer system improvement projects in the County parks system (Toro, Royal Oaks, Manzanita, Jacks Peak, Lake San Antonio, and Lake Nacimiento). Funds are distributed between the parks based on initial project cost estimates. Many of the existing systems are well beyond useful life and experience regular breakdowns. ARPA funding for County Park water and sewer systems allows the County to provide drinking water and more reliable sanitation systems and facilities for park visitors.

Total FY 2023-24 Budget: \$3,332,132
Total Project Budget: \$7,656,221
Est. Project Completion Date: 6/30/2024

Prop 68 Per Capita Grant:

This project implements various repair and improvement projects in County Parks, including repairs to the Toro Park Buckeye BBQ structure, bathroom roof replacement at Jacks Park, and campsite improvements and removal of unusable modular units at Lake San Antonio and Lake Nacimiento. The County will receive \$631,430 from California Proposition 68, which authorized \$4 billion in general obligation bonds to finance drought, water, parks, climate, coastal protection, and outdoor access for all programs. The County required local match is \$157,858, for a total project budget of \$789,288.

Total FY 2023-24 Budget: \$369,288

Total Project Budget: \$789,288

Est. Project Completion Date: 6/30/2024

San Ardo Yard – New Modular:

Install a concrete pad and modular office building and provide utility connections. The San Ardo District 4 Road Maintenance office is currently housed within a World War II era steel shell building. The current estimate is based on the standard calculation for design and engineering construction management and contingency costs for a project in the pre-design stage. Construction cost is based on a recent modular unit procurement.

Total FY 2023-24 Budget: \$490,005

Total Project Budget: \$550,000

Est. Project Completion Date: 6/30/2024

Sheriff Multiple Projects:

Five projects began in FY 2021-22 for the Sheriff's Department, including installing a washer and dryer, replacing and installing new kitchen gutters, replacing refrigeration compressors, installing an automatic transfer switch, and repairing three main jail water softeners. Due to material delays, replacing the refrigeration compressors and installing the automatic transfer switch will need to roll into FY 2023-24.

Total FY 2023-24 Budget: \$880,068

Total Project Budget: \$1,087,507

Est. Project Completion Date: 6/30/2024

Fund 404:**Natividad Medical Center Capital Projects**

FY 2023-24 Recommended Budget for Fund 404 Natividad Medical Center includes the following:

Pharmacy Remodel:

The Pharmacy Department develops intravenous (IV) medications that are introduced directly into the bloodstream, bypassing the anti-infective defenses of the stomach and skin. Contaminated compounding IV medications can result in patient harm due to infections. To prevent contamination, trained staff must develop medications using proper procedures in facilities designed in order to avoid contamination. The current IV compounding facility in the Pharmacy Department does not meet new regulations set by the California State Board of Pharmacy for IV compounding. This project has updated the

facility to meet new laws and regulations by providing a new compounding room with a new non-hazardous anteroom and a hazardous medication storage room. The Board of Supervisors approved the Pharmacy project in the total amount of \$1,905,411. OSHPD approved this project on June 11, 2019, and NMC initiated the project as a JOC project to Staples Construction. NMC started construction on September 21, 2020. Construction has completed this initial scope of building and is pending acceptance from the Board of Pharmacy and the California Department of Public Health (CDPH).

There has been a need to expand the capacity of the Pharmacy Department. During the pandemic, the Pharmacy has added two new freezers, supplies for COVID-19 medications and vaccines, so workflow needs to be modified to accommodate the additional supplies. Documents have been submitted to OSHPD to temporarily utilize the corridor to proceed with the remaining phase of the Pharmacy remodel.

Total FY 2023-24 Cost: \$513,469

Total Project Cost: \$1,905,411

Est. Project Completion Date: December 2023

Laboratory Remodel/Phlebotomy

The Laboratory is where specimens are collected and tested to obtain information about the health of a patient as it pertains to the diagnosis, treatment, and prevention of disease. The phlebotomy area needs to be renovated to improve esthetics for better patient comfort during patient procedures. The blood bank needs additional space for specimen processing. Staff is working with new leadership in the laboratory to develop a better floorplan to increase productivity and workflow. The remaining balance for the Laboratory Remodel/Phlebotomy project is \$572,161 as of March 2023.

Total FY 2023-24 Cost: \$572,161

Total Project Cost: \$600,000

Est. Project Completion Date: June 2024

Natividad Refresh of Med Surg

This project includes a comprehensive remodel of the Medical/Surgical Unit third floor. The remodel included refurbishment of all patient rooms, corridors and nurse stations. The area has not been modernized since it was constructed in 1999. This project will involve several smaller projects aimed at the same goal of refurbishing specific areas primarily focused on furniture replacement (patient, visitor and staff areas) and refurbishing collectively other areas considered small projects. This is estimated to be a three-year project.

Total FY 2023-24 Cost: \$858,209

Total Project Costs: \$5,600,000

Est. Project Completion Date: June 2025

Fire Alarm Replacement:

The Fire Alarm panels are Siemens MXL and monitor fire alarm devices throughout the Natividad Medical Centers campus. Unfortunately, the Fire Panel is at the end of life, and parts are no longer available for the system. Currently, the facility is looking at replacing the fire panels with modern Siemens SLX fire panels. The new panels will directly replace and migrate all the existing devices on the fire alarm system and allow the facility to upgrade fire alarm devices as areas of the facility get remodeled or renovated.

Total FY 2023-24 Cost: \$400,000
Total Project Costs: \$1,400,000
Est. Project Completion Date: December 2025

ER Modular Building:

The Emergency Department (ER) is located in building 500 on the first floor. Natividad Medical Center treats medical emergencies and has emergency specialists that are available 24 hours a day from everything from general illnesses and disease to life-threatening conditions. The 18-bed emergency department is staffed with emergency room physicians, physician assistants, and specially trained registered nurses and technicians.

The modular building would implement additional Emergency Department lower-acuity treatment space in order to accommodate periods of rising census. Current space constraints result in increased ED wait times, increased patient left without being seen (LWBS) and patient elopement, decreased patient satisfaction and decreased quality of care.

The building will be placed outside of the Emergency Department in the south parking lot. Currently we have received a feasibility study from Kasavan architects and received an estimated cost.

Total FY 2023-24 Cost: \$3,800,000
Total Project Costs: \$3,800,000
Est. Project Completion Date: June 2024

Parking Lots and Roadwork:

Throughout the campus of NMC, the roadways need improvement, from resurfacing and restriping the parking lots to providing additional parking spaces and resurfacing the main roadway. The Parking Lots and Roadwork project was approved by the Board of Supervisors on March 1, 2016. Funding was added to the project to repair and stripe the main campus roadway and seal and stripe the parking lots.

Total FY 2023-24 Cost: \$400,000
Total Project Costs: \$1,184,128
Est. Project Completion Date: December 2025

Fund 404:

Information Technology Capital Projects

FY 2023-24 Recommended Budget for Fund 404 Information Technology Department includes the following:

ITD Data Center System End of Life Replacement:

The ITD Data Center System End of Life Replacement project replaces critical end of life, unusable equipment, and creates a secure and highly available computing environment for County’s critical IT infrastructure. Project scope includes upgrading virtual systems hosts, storage area network with fiber channel switches, backup solution media agent servers and Microsoft operating systems which will be approaching end of life within one to two years.

Total FY 2023-24 Budget: \$488,000
Total Project Budget: \$1,038,000
Est. Project Completion Date: 6/30/2024

Countywide Network End of Life Replacement:

Countywide Network End of Life Replacement project replaces critical end of life, unusable network equipment, and creates a secure and highly available County network for County’s critical IT infrastructure. Project scope includes upgrading all switches and routers which will be approaching end of life by April 2027. All Cisco 3650 switches will be at end of support and end of life by October 2026 with an estimated cost of \$3.7 million. Cisco 3850 switches will be end of support by April 2027 with an estimated cost of \$1.4 million.

Total FY 2023-24 Budget: \$1,000,000
Total Project Budget: \$5,100,000
Est. Project Completion Date: 6/30/2028



This page intentionally left blank.

Debt Management Policy

Section 1 – Introduction

The purpose of the County of Monterey (the "County") Debt Management Policy (the "Policy") is to ensure sound and uniform practices for issuing and managing debt. The County recognizes that it may need to enter into debt obligations to finance projects and to meet fiscal responsibilities. Accordingly, this Debt Management Policy confirms the commitment of the Board of Supervisors (the "Board"), staff, advisors and other decision makers to adhere to sound financial management practices.

The County's Comprehensive Annual Financial Report lists a number of legally separate organizations ("component units") for which the Board is financially accountable. This Policy informs the actions of these component units to ensure a uniform approach to the issuance of debt.

The procedures set forth herein shall be followed in connection with all proposed offerings of bonds, notes, or other debt instrument financings authorized by the County, and any other entity for which the Board, or other County agency, is the governing body. The Board adopted a Public Financing Policy ("Debt Management Policy") on May 19, 1998 which incorporated as an addendum the Mello-Roos Community Facilities District Financing Policy, previously adopted by the board on March 25, 1991. Revising resolutions were approved: on October 8, 2002 to address statutory changes and to more appropriately provide financial protection to the County for issuance of Mello-Roos debt; August 16, 2005 to add Certificates of Participation to General Obligation Bonds for purposes of calculating debt ceilings; on July 11, 2006 to establish the Capital Improvement Plan and Committee, and on April 21, 2008 to further amend policies, and on February 14, 2012 to delete reference to the Debt Advisory Committee (DAC). Those amendments and original policy are modified and restated herein. This revised policy as of July 25, 2017 ensures the County's compliance with requirements pursuant to California Senate Bill 1029, which amended Section 8855 of the California Government Code and became effective in January 2017. Such requirements pertain to how the policy's goals relate to the County's planning goals, capital improvement program, and overall objectives. The updated policy herein also contains new language to ensure the County's ongoing diligence with respect to financial disclosure, monitoring, and recordkeeping.

The proper utilization of debt is a major financing tool of the County – supplementing and/or leveraging other sources of financing such as allowed taxation, fees for services, fines and grants. Costs versus benefits/risks of

borrowing will be a major consideration when evaluating each proposed use of debt as a source of financing specific county needs.

Debt is utilized by the County to address County-wide business needs and Board of Supervisor goals and objectives, and when it is determined to be the most prudent and cost-effective method for meeting general or specific needs and service requirements. Debt proposals must be closely coordinated with the county's capital and operating budget processes and must consider the impact of the proposed debt issue on the county's credit rating and total debt burden, as well as long-term goals, objectives and financial forecasts. Repayment of borrowed funds is of paramount concern to the County. Proper structuring and continued management of county debt is critical.

1.1 Policy Objectives

The Policy objectives are as follows:

- Establish a systematic and prudent approach to debt issuance and debt management.
- Ensure access to debt capital markets and direct purchase investors (private placement providers) through prudent and flexible policies.
- Define specific limits or acceptable ranges for general fund supported debt and pension obligation debt.

1.2 Scope

This Policy governs the issuance and management of all debt and lease financing activity by County entities and component units. The debt policies and practices of the County are subject to and limited by applicable provisions of state and federal law and to prudent debt management principles.

The County uses financing techniques prescribed under existing law for projects that require financing beyond the current fiscal year. These techniques can include, but are not limited to, certificates of participation, lease-back arrangements, and revenue and assessment bonds.

Section 2 – Debt Advisory Committee

The Debt Advisory Committee (DAC) shall be reestablished, consisting of the Auditor-Controller, Treasurer-Tax Collector, and County Administrative Officer, or their designees, for the purpose of reviewing and advising the Budget Committee, Capital Improvements Committee, and the Board regarding proposed and existing debt issues in which the Monterey, or other entity for which the Board is the governing body, has complete or limited obligation for debt repayment. Such debt issues include, but are not

limited to General Obligation Bonds, Revenue Bonds, Certificates of Participation (COPs), Tax Allocation Bonds, Special Assessment Bonds, Revenue Securitizations, Judgment Obligation Bonds, Conduit Debt, Mark-Roos and Mello-Roos financings, Tax and Revenue Anticipation Notes (TRANS), and other short term financings. The DAC may utilize the services of an independent municipal advisor when analyzing the proposed financing.

The Auditor-Controller or his or her alternate will chair the DAC. The Treasurer-Tax Collector or his or her alternate will act as the vice chair. The chair shall be responsible for providing the functions of a recording secretary if the DAC deems such services to be necessary.

2.1 DAC Responsibilities

The DAC shall meet to consider County public financing proposals, refunding opportunities, or other debt management issues. A Debt Action Request (DAR) will be presented to the DAC by the County Administrative Office summarizing the action(s) requested (i.e., proposed financings, refunding opportunities, material events disclosure requirements, arbitrage issues, recommendations, policy, and other matters), all pertinent information surrounding the request, analysis, findings, and justification for a recommended course of action.

The DAC will consider and discuss the DAR and any additional relevant information required to make an informed decision. This may include seeking input and analysis from other internal and/or external resources, as deemed appropriate. The DAC will approve, modify, or deny the DAR, as determined by the DAC to be in the best interests of the County. If the DAC approves or modifies the DAR, the County Administrative Office will be responsible for implementation of requested action(s). If the DAC advises denial of the request, a written explanation of the Committee's reasoning will be provided to the requesting agency, committee, or department by the County Administrative Office within 10 days of the meeting, or as determined to be an appropriate and reasonable timeframe based on the requesting entity and purpose of the request.

For each individual issue, the DAC will analyze the current market conditions, benefits to be derived from the financing, potential risks, debt service burdens, revenue streams, sector expertise, cost of issuance, statutory restraints, current and projected market conditions, and other factors to determine debt structure, the method of sale, the financing team composition, term, use of credit enhancement, and method of awarding contracts.

Section 3 – Issuance of Approval Process

The approved Monterey County Capital Improvement Plan (CIP) and other Board approved or referred projects are the primary foundation for debt financing consideration for County serviceable debt. Debt proposals may originate from the Board, the Budget Committee, the issuing agency, and/or the recommending department. Debt for projects not eligible as a CIP project (non-recurring, less than \$100,000, and/or useful life of less than five years) may be recommended by the agency or department proposing such issuance. A department, agency, or committee proposing a debt issue will submit a written report (in Board report format) to the County Administrative Officer, or designee, fully describing the proposed project, which specifically addresses the following:

- Purpose and feasibility of the proposed project.
- Public benefit derived from the project.
- Available project financing sources and alternatives (grants, etc.).
- Estimated total costs of the project (excluding cost of financing).
- Estimated timeline for completion of the project.
- Estimated additional ongoing operational costs resulting from the project.
- Appropriate revenue streams available for debt service.
- Proposed collateral to be pledged.
- Estimated total General Fund impact from debt service requirements and changed operational costs.

A DAR will be presented by the County Administrative Officer, or designee, for DAC review. DAC's review, findings, and recommendations will be presented to the Budget Committee for consideration and, if appropriate, referral for full Board consideration for approval to engage the financing team of external finance professionals. The County Administrative Office will be responsible for presentation, in coordination with the proposing department, agency, or committee.

3.1 Standards of Debt Financing

The County will minimize the level of direct debt by incurring debt only in those cases where public policy, public interest and/or economic efficiency favor debt over

cash financing or grant funding. In addition, the County shall use self-supporting (debt-service neutral or better) debt when possible.

The County in most cases will issue debt to finance capital projects. Other possible reasons to issue debt include (but are not limited to) refinancing unfunded pension liabilities, allowing the County to cover periods of temporary cash shortfalls, refinancing bonds, and paying obligations imposed by law. Except to alleviate cash-flow timing issues within a fiscal year, the County will avoid using debt to finance reoccurring operating expenses. All debt issuance will fall within the limits permitted by the California Constitution and state law.

Section 4 – General Debt Policies

4.1 Purpose of Debt

There are two basic types of debt: new money financings and refunding financings.

4.1.1 New Money Financings

The County may issue long-term debt to generate funding for capital projects. Short-term debt may be issued to generate funding for cash flow needs.

4.1.2 Refunding Financings

Refunding bonds are issued to retire all or a portion of an outstanding bond issue or other debt. Such bonds can be used to achieve present value savings on debt service, to modify interest rate risk, or to restructure the payment schedule, type of debt instrument used, or covenants of existing debt. The County must analyze each refunding bond on a present value basis to evaluate the economic effects. Policies on the administration of refunding bonds are detailed in Section 4.13 “Debt Refunding.”

4.2 Use of Debt

Debt should be used when it is in the best overall interest of the County, including appropriate short-term borrowings and financing of certain assets with substantial useful and economic lives. The term of the debt must not exceed the useful life of the financed asset and, ideally, it should match or have a duration of less than the useful life of the asset.

Debt may be issued to finance needed equipment, facilities or infrastructure identified by the Capital Improvement Committee or adopted County Budget.

Debt may be issued to fund short-term operating and/or cash flow needs of the County, but must be repaid within 13 months from date of issuance. Debt may be issued for

refunding existing debt when a reasonable overall net savings can be realized.

4.3 Legal Limitations

All debt issued by the County shall be in compliance with all pertinent State and federal statutes and in compliance with all regulations promulgated by agencies that maintain jurisdiction over debt issuance. All debt issues by the County shall conform to the provisions of this policy, unless waived by the Board. The Board, by resolution dated August 16, 2005, extended the General Obligation bond debt ceiling of 1.25% of countywide assessed value to include COPs financings.

4.4 Bond Proceeds

The use of proceeds from long-term financings will be limited to the uses authorized by law and allowed by the provisions of the particular debt issue. Generally, these limitations will allow for paying costs of planning, design, land, construction or acquisition of buildings, permanent structures, attached fixtures and/or equipment, movable furniture and equipment, and the costs of planning and issuing the debt.

The uses of short term financing will include funding the County’s cash flow deficit in anticipation of tax and revenue receipts.

Proceeds of debt will be held either (a) by a third-party trustee, which will disburse such proceeds to the issuer upon the submission of one or more written requisitions, or (b) by the issuer, to be held and accounted for in a separate fund or account, the expenditure of which will be carefully documented by the County.

4.5 Avoiding Negative Impact on General Fund

Expenditures and investment transactions related to borrowings for funds other than the County’s General Fund shall be structured to eliminate, to the maximum extent possible, direct and or indirect negative impacts on the General Fund. Interim funding for project expenditures shall be established and financed from proceeds of borrowings (or other appropriate sources) to avoid delays in draw-downs or reimbursements which would have the effect of reducing General Fund interest earnings.

4.6 Debt Issue Size

The amount of any financing should be held to a minimum, taking into consideration any available existing funds to partially finance project costs. Reasonable revenue coverage will be required for all issues. Bond reserve funds and capitalized interest should generally be minimized or

eliminated to reduce borrowing size, unless it is in the County's best interest to do otherwise, or if such funds are required as a function of law, regulation, or market conditions. Debt will only be issued to cover authorized costs as indicated in the preceding section on Bond Proceeds. Generally, debt will only be issued upon receipt of acceptable and reliable project construction bids. In certain situations, reliable estimates may be the basis for debt issuance.

4.7 Debt Level/ Affordability Targets

The County shall establish an affordable level of debt to preserve credit quality and ensure financial stability. As such, aggregate General Fund lease debt service should not fall more than within a range of four to six percent (4%-6%) of General Fund expenditures. The County shall maintain a debt affordability model with ratios recalculated at the time of a new debt issue. The DAC and the Board will be notified if any new issuance would cause the ratio to exceed the threshold. Both DAC and Board approval would be required before the County is allowed to exceed the ratio threshold.

A component unit may be allowed to exceed the above target ratio if the unit generates user fees through a business-type activity. The component unit must, however, repay the debt with money generated by user fees or other dedicated revenue sources.

The above target ratio does not include the County's pension and retiree health care unfunded actuarial accrued liabilities (UAAL), which itself is a form of "debt" owed to retirement plan members

4.8 Tax Status

It is the County's policy to issue tax-exempt obligations and to avoid taxable status on County borrowings unless it is determined that taxable status would be in the best interest of the County. Generally, tax-exempt bond issues are subject to IRS arbitrage rebate requirements. These requirements specify that any profit or arbitrage be rebated to the federal government. Rebate computations are typically required every five (5) years and upon final redemption or maturity of the bonds. Any excess earnings are required to be rebated to the federal government. As primarily a tax-exempt borrower, the County will comply with applicable IRS regulations and provisions including arbitrage rebate calculations, rebate of arbitrage profits, and any necessary tax filings.

4.9 Taxpayer Equity

If a debt issuance is to be financed by General Fund revenues, the proposing department must demonstrate a benefit to a significantly large proportion of the County's property taxpayers. If the project would primarily serve a definable group of taxpayers, the obligation to repay the debt should be borne by that group of taxpayers, when feasible. In certain instances, the Board may determine that exceptions to this general guideline would be in the best interests of the County.

4.10 Authorized Method of Sale

The County's goal is to protect the public's interest by obtaining the lowest possible interest cost. To obtain this goal, the County may use a competitive, negotiated, limited-competitive (hybrid) or private placement method of sale. The appropriate method should be determined on a case-by-case basis.

Before selecting a method of sale for public offerings, the financing team shall take into consideration the current market, the issuer's characteristics, and the proposed bond structure. Market considerations will focus on the supply and demand of competing issuances. Issuer characteristic considerations will include market familiarity, credit strength, and policy goals. Bond structure considerations will include the type of debt instrument, issue size, structure, and timing.

Determination of whether to sell bonds under a competitive bid or a negotiated sale will depend on many factors, including the market environment, timing considerations, structure of financing, and the type of bond or other financing instrument. For certain types of debt instruments and financing structures, competitive sale is generally the method by which the County can obtain the lowest interest cost, and is required for specified types of debt issues. However, in some circumstances, competitive sale may not be feasible or practical, and in some situations, the use of negotiated sales may provide a more favorable financial outcome. Thus, the method of sale must be analyzed by the County, and if used, the municipal advisor, prior to any debt issue. Private placement may be used for any debt issue structured specifically for one purchaser, typically, a bank, insurance company, broker dealer, or leasing company. Financial analysis and professional concurrence must precede any private placement issue.

4.10.1 Competitive Sale

In a competitive sale, competing underwriters deliver sealed bids to the County, at the time and place specified

in the Official Notice of Sale. The County selects the underwriter offering the best terms at the time. Bids will be awarded on a True Interest Cost (TIC) basis, providing other bidding requirements are satisfied. TIC is a method of calculating bids for new issues that takes into consideration certain costs of issuance and the time value of money. In such instances where the County Administrative Office deems the bids received unsatisfactory, the County Administrative Office may enter negotiations for sale of the securities or reject all bids. The Official Notice of Sale will be carefully constructed to ensure the best possible bid for the bonds, in light of existing market conditions and other prevailing factors

4.10.2 Negotiated Sale

A negotiated sale is a sale of bonds whereby the terms and price are negotiated by the County and the municipal advisor through an exclusive agreement with a previously selected underwriter and/or underwriting syndicate. In many cases, County debt is issued via a negotiated process, which provides the County control over the financing structure, the issuance timing and flexibility of distribution.

4.11 Debt Credit Rating

The County seeks to maintain and, if possible, improve its current long and short-term debt ratings to enhance the County's reputation within the financial community and to minimize borrowing costs. Emphasis should be placed on protecting the General Fund and enhancing the County's financial condition. Further, the County will maintain good communication with the bond rating agencies and keep them apprised about the County's financial condition through provision of relevant reports and documents.

The County may solicit a credit rating review at its discretion, typically done in the context of a bond transaction. It is the County's policy to solicit ratings from Nationally Recognized Statistical Ratings Organizations (NRSRO) for its debt issues, including Fitch Ratings, Moody's Investor Services, and Standard & Poor's. A single credit rating may be utilized if/when it is financially advantageous to do so and upon advice from the County's municipal advisor, or/and underwriter.

4.12 No Public Financing for the Purpose of Arbitrage

The County shall be prohibited from issuing arbitrage bonds. Permitted investment of proceeds must be clearly defined prior to each issuance. Planning, contract, and construction delays must be managed to assure compliance with the various exceptions afforded by the Internal Revenue Service (IRS) concerning arbitrage, such as the 6-

month, 18-month, 3-year and 5-year exceptions, when applicable.

4.13 Debt Refunding

The County is responsible for acting upon refunding opportunities that offer significant savings over the maintenance of existing debt. Periodically, the County will analyze and evaluate debt repayment opportunities based on current market conditions. Additionally, the County may request or receive analysis of an opportunity to refund existing debt from a municipal advisor or other municipal financial market participant. The County will consider such opportunities and evaluate the economic benefit they may present.

Outstanding debt issues may be refunded, if permissible by federal tax law and the terms of the debt instrument, if refunding results in an acceptable level of debt service savings. Other structural aspects are to be determined by the DAC, municipal advisor or/and underwriter.

As defined for federal tax law purposes, the County may issue current or advance refunding bonds when advantageous, legally permissible, prudent, and when the aggregate net present value savings (expressed as a percentage of the par amount of the refunding bonds) equal or exceed three percent (3%). Refunding's of current debt shall be made only if recommended by the DAC and the County Admirative Office, and approved by the Board. Refundings that produce negative savings will not be considered, unless there is a compelling public policy objective.

Within federal tax law constraints, a refunding will be considered if and when there is a net economic benefit or if it is imperative in order to modernize covenants essential to operations and management. A current refunding provides that all proceeds (aside from expenses and reserve fund, if required) are used to extinguish existing debt at a savings to the County in the overall repayment costs. Managers of existing projects may request refundings for the purpose of taking advantage of more favorable economic conditions and lower market interest rates, restructuring the principal and debt service payments, or eliminating burdensome covenants with bondholders. Advance refundings used to refinance outstanding debt before the date the outstanding debt becomes due or callable. Proceeds of advance refunding bonds are placed into an escrow account with a fiduciary agent and used to pay interest and principal on the refunded bonds until final redemption at their maturity or call date.

The financial advantages of a refunding must outweigh the costs and risks of reissuing bonds. The request for refunding will be assessed with competing new capital projects requiring financing. In no event will the maturity date of the refunding issue exceed the original maturity date of the refunded debt.

Savings requirements for current or advance refunding undertaken to restructure debt may be waived at the recommendation of the County Administrative Office, in consultation with the municipal advisor, with DAC and Board approval, upon a finding that such a restructuring is in the County's overall best financial interest.

4.14 Primary and Continuing Disclosure

Primary disclosure shall include the preliminary official statement (POS) and the official statement (OS), which shall be prepared in a manner consistent with applicable securities laws and the Government Finance Officers Association (GFOA) guidelines. In connection with a debt issuance, the County may undertake to provide continuing disclosure in order to enable the underwriters of such debt to comply with the requirements of Securities and Exchange Commission (SEC) rule 15c2-12. Disclosure certifications shall be acknowledged by the Office of the Auditor-Controller who shall be responsible for the County's continuing disclosure undertakings.

After entering a Continuing Disclosure undertaking (i.e., a contract), the County shall comply with the terms of such undertaking. Not only must all filings be made in a timely manner, if for any reason there is a failure to make a timely filing, such failure also must be disclosed (and could reflect negatively on the County). The Office of the Auditor-Controller will take all reasonable steps to ensure that the County files timely annual reports and "listed event" (there are currently 15 such events) notices with the Municipal Securities Rulemaking Board's (MSRB's) Electronic Municipal Market Access system (EMMA), and that all such filings are (i) complete and accurate under the law and (ii) clear, concise and readable for the investing community.

The County may also (i) select certain staff members to be the County's "disclosure team" that, with the County Administrative Office, develops and employs disclosure practices and procedures that are effective, reasonable and defensible and (ii) engage with an external disclosure counsel to provide additional guidance and training. The County may also from time to time evaluate using the services of a dissemination agent, such as the County's

municipal advisor or Digital Assurance Certification, LLC, or some other third-party entity to assist with compliance.

4.15 Investment of Bond Proceeds

Bond proceeds shall be invested as permitted by the instrument pursuant to which the bonds are issued and pursuant to the County's investment policies. The County Administrative Office will determine the investment structure reasonably expected to produce the results which are in the best interest of the County as it relates to the issue. Bond proceed investment can be managed by the County Treasury, Guaranteed Investment Contracts, or outside investment managers within the scope allowed by the instrument pursuant to which the bonds are issued.

4.16 Timing of Debt Issuance

Debt should be issued to correlate with the need for funds. For long-term projects, issuance should only occur when there is a verifiable need and reasonable expectation of compliance with statutes.

4.17 Expenditure of Bond Proceeds

Any new construction or project acquisition monies raised through debt issuance will adhere to the specific "Use of Proceeds" disclosures provided in the instrument pursuant to which the bonds are issued and any statutory requirements.

Annually, the Office of the Auditor-Controller shall submit a report to the California Debt and Investment Advisory Commission (CDIAC). The annual report will cover the period July 1, to June 30, inclusive and shall be submitted no later than seven months after the end of the reporting period by any method approved by CDIAC. The annual report shall, among other things, include the use of proceeds of issued debt during the reporting period, including the following:

1. Debt proceeds available at the beginning of the reporting period.
2. Proceeds spent during the reporting period and the purposes for which it was spent.
3. Debt proceeds remaining at the end of the reporting period.

4.18 Arm's Length Transactions

The County will endeavor to have "Arm's Length Transactions," in which the buyers (underwriters) of the debt have no relationship with the County. For Arm's Length Transactions, the County and the buyer are both

acting in their own self-interest and are not subject to any pressure or duress from the other party.

4.19 Records Retention

Documentation relating to each particular financing will be retained for the term of the financing plus three years, including all refundings. Storage may be in hard copy or electronic format.

Section 5 – External Finance Professionals

The County Administrative Office will be responsible for dissemination of requests for proposal (RFP), at least every three (3) years, to establish pre-approved lists of financing professionals from which issue specific teams will be selected. The County Administrative Office will assemble issue specific teams based on factors, including but not limited to, experience of the firm and individuals, issue specific expertise, scope of services to be provided, financial strength, recommended strategies, industry reputation, and pricing. Awards will not be based on price alone, but instead on which combination of professionals will result in the lowest overall borrowing costs to the County.

Most financing professionals are compensated from bond proceeds upon issuance. However, legal, municipal advisory, and feasibility consultant services may require payment for hourly services regardless of whether an issue is sold. Arbitrage rebate consultants, trustees, paying agents, and custodians generally charge annual fees for services provided after issuance.

5.1 External Finance Professionals

- A. **Bond Counsel:** Prepares necessary bond resolutions, bond indentures, establishes underlying legal framework for the issuance, reviews all documentation and opines as to legalities relating to the issue.
- B. **Disclosure Counsel:** Prepares the official statement or other disclosure for a debt issue.
- C. **Tax Counsel:** Opine on tax matters associated with the offering and preparation of filings necessitated by IRS rules.
- D. **Independent Municipal Advisor(s)** (MA): May be engaged by the County, if deemed advisable or appropriate by the DAC, to provide independent analysis to the County of proposed public financings on such terms and conditions as ratified by the Board. The County Administrative Office, subject to Board ratification, shall have the discretion to hire MAs with respect to any particular proposed public financing or more generally to provide advice with respect to the public financing needs of the County on a periodic basis. The MA, and any related entity, shall be prohibited from: (i) receiving any payments from the underwriter(s) with respect to the proposed public financing; and (ii) selling any securities or derivative products to the County during the period it is acting as MA to the County. In the event it is determined that it is not necessary or advisable for the County to hire a MA with respect to a particular proposed public financing, the County shall perform any responsibilities which might otherwise have been performed by the MA.
- E. **Feasibility Consultants:** Determine feasibility of complex debt issues as required by statute or at the County's discretion.
- F. **Underwriters:** Contractually commit to purchase and market the debt issue on negotiated sales, or may be the successful bidder(s) on competitive sales.
- G. **Underwriter's Counsel:** Selected by the underwriter to act as counsel to the underwriter on negotiated sales.
- H. **Special Tax Counsel:** Advises the County and bond counsel on tax related matters if tax counsel does not have the appropriate level of expertise. Customarily applicable to Mello Roos issuance.
- I. **Ratings Agency Analysts:** Conduct financial reviews of the County and the debt issue to assign short and/or long-term ratings and will monitor the County's financial condition for possible adjustments to the assigned rating. Subsequent reviews can be initiated by either the County or the ratings agency.
- J. **Credit Enhancement Providers:** Provide credit enhancements for debt issues including, but not limited to, insurance, liquidity facilitation, and letters of credit. Banks providing enhancement must be rated at least "A" by an NRSRO, approved by the County, and properly licensed to conduct business within the state of California. Bond insurance must be provided by nationally recognized municipal bond insurers who are rated

at least “A” by an NRSRO. Contracts with credit enhancement providers should be structured, if possible, to protect the County’s interests in the event of ratings downgrades, financial deterioration of the enhancement provider, and other material events likely to affect the issuance.

- K. **Arbitrage Consultants:** Calculate investment returns on bond proceeds, arbitrage rebate amounts, and prepare the associated tax returns and forms.
- L. **Trustees, Registrars, Paying Agents, and Fiscal Agents:** Banks or trust companies that provide vital corporate trust services throughout the term of the debt issue.
- M. **Investment Advisors:** Provide advice as to investment of proceeds of debt issuances in appropriate investment vehicles.

Section 6 – Financial Disclosure, Monitoring, and Recordkeeping

To assure clear, comprehensive, and accurate financial information, the County is committed to meeting secondary disclosure requirements on a timely and comprehensive basis, cooperating fully with rating agencies, institutional and individual investors, County departments and agencies, other levels of government, and the general public. Complete and accurate disclosure supports the taxable or tax exempt status of bonds issued by the County and provides transparency regarding County finances and operations.

The County Administrative Office, Treasurer-Tax Collector, and Auditor-Controller, pursuant to their authority, shall be responsible for the following as they apply to County long-term and short-term debt issues:

- A) Providing the trustees and/or dissemination agents ongoing disclosure information for filing with the MSRB via EMMA. The County may elect to utilize the services of a dissemination agent for continuing disclosure reporting; however, the responsibility for ensuring the reports are filed timely remains with the County.
- B) Maintaining compliance with disclosure standards promulgated by State and Federal regulatory bodies.

C) Ensuring the Comprehensive Annual Financial Report (CAFR) and continuing disclosure statements meet (at a minimum) the standards articulated by the Government Accounting Standards Board (GASB), the SEC, and Generally Accepted Accounting Principles (GAAP).

D) Monitoring to ensure all covenants and annual continuing disclosure requirements are complied with, including requiring each County department, agency, district, or authority to notify the County Administrative Office immediately upon the occurrence of any event, specified in Rule 15c2-12 under the Securities Exchange Act of 1934, which must be filed with EMMA. Examples of such events are credit rating downgrades, major disasters, major litigation, default on existing debt, bankruptcy, etc. and for Tax and Revenue Anticipation Notes (TRANS) issuance, ensuring cash deficit requirements are met for each issuance, to meet arbitrage and rebate requirements and protect the tax-exempt status of each issuance.

E) Submit an annual report to the CDIAC. The annual report will cover the period July 1, to June 30, inclusive and shall be submitted no later than seven months after the end of the reporting period by any method approved by CDIAC. The annual report shall consist of the following:

- 1. Debt authorized during the reporting period, which shall include the following:
 - Debt authorized at the beginning of the reporting period.
 - Debt authorized and issued during the reporting period.
 - Debt authorized but not issued at the end of the reporting period.
 - Debt authority that has lapsed during the reporting period.
- 2. Debt outstanding during the reporting period, which shall include the following:
 - Principal balance at the beginning of the reporting period.
 - Principal paid during the reporting period.
 - Principal outstanding at the end of the reporting period.

3. The use of proceeds of issued debt during the reporting period, which shall include the following:
 - Debt proceeds available at the beginning of the reporting period.
 - Proceeds spent during the reporting period and the purposes for which it was spent.
 - Debt proceeds remaining at the end of the reporting period.

- F) When applicable, applying the private business use, private payment or security, and the private loan financing tests to ensure the tax-exempt bond issues are not issues of private activity bonds. Monitoring shall include:
 1. Reviewing the amount of existing private use of bond-financed facilities,
 2. Identifying any new sale, lease or license, management contract, or other arrangements involving the private use of a bond-financed facility, and
 3. Promptly consulting with bond counsel as to any possible private use of a bond-financed facility and any necessary remedial action. Generally, an issuer will not loan more than five percent (5%) of the proceeds of an issue to one or more nongovernmental persons. The issuer does not expect to allow and will not allow more than ten percent (10%) of the sale proceeds and investment proceeds of the issue or of the bond-financed facility to be privately used directly or indirectly by any nongovernmental person in any trade or business, other than as a member of the general public. For purposes of the preceding sentence, "10%" is reduced to "5%" for nongovernmental use of any facility financed or refinanced from the proceeds of an issue which are disproportionate to or not related to the governmental purposes of the issue. Absent an opinion of counsel a nongovernmental person is treated as "privately using" proceeds of the issue to the extent the nongovernmental person:
 - a. borrows proceeds of the issue,
 - b. uses the bond-financed facility (e.g., as owner, lessee, service provider, operator or manager), or
 - c. acquires the output (or throughput) of the bond-financed facility.

- G) When applicable, establishing and maintaining a system of monitoring, reporting and recordkeeping to meet the arbitrage rebate compliance requirements of the federal tax code. Arbitrage in the municipal bond market is the difference in the interest paid on the tax-exempt bonds and the interest earned by investing the bond proceeds in taxable securities. If interest rates on investments are higher than the interest on the bonds, there is positive arbitrage. The tax code requires that, to the extent the investment yield exceeds the bond yield, such excess must be rebated to the federal government, subject to the exceptions discussed in paragraph 3, below. The system shall include annually:
 1. Ensuring investments of proceeds comply with yield restrictions throughout their investment life;
 2. Tracking the investment earnings on bond proceeds since issuance and calculating any rebatable earnings (rebatable earnings are amounts earned from the investment of the gross bond proceeds at a yield in excess of the yield on the issue);
 3. Applying exceptions to the application of rebatable earnings for certain investments of bond proceeds [e.g., if investments were (i) during a temporary period, (ii) part of a reasonably required reserve or replacement fund, or (iii) as part of a minor portion (an amount not exceeding the lesser of 5% of the sale proceeds of the issue or \$100,000)];
 4. Remitting any rebatable earnings to the federal government no later than sixty (60) days after the end of every fifth (5th) bond year throughout the term of a bond issue. The County Administrative Office has the authority to contract with parties specializing in arbitrage/rebate calculations, if deemed necessary; and

5. Satisfying the Arbitrage Rebate/Yield Reduction Filing Requirements-Form 8038-T or Form 8038-R, if applicable.
- H) Ensuring debt service for all existing and anticipated debt is properly budgeted and appropriated for each fiscal year and documenting any specific revenue sources for repayment.
- I) Initiating scheduled debt service payments.
- J) Reconciling bank statements for money managed by trustees.
- K) Validating all payments for construction and other debt related expenditures.
- L) Retaining all material records related to bond financings, in a combination of paper and electronic forms, including, but not limited to:
1. Records relating to the bond transaction, including documents prepared by bond counsel, audited financial statements, offering documents (including the official statements), minutes and resolutions authorizing the bond financings, appraisals, surveys, feasibility studies, documents related to government grants, publications/articles related to County bond financings, correspondence, any IRS correspondence or examinations, and arbitrage related documents and calculations;
 2. Documentation evidencing expenditure of bond proceeds;
 3. Documentation evidencing use of bond-financed property;
 4. Documentation of allocation of bond proceeds to issuance costs;
 5. Copies of construction and purchase contracts, requisitions, draw schedules, draw requests, invoices, bills, and cancelled checks related to bond proceeds spent for construction or purchase of bond financed facilities;
6. Copies of all agreements, contracts, leases, subleases, ownership documentation, and entity formation documentation;
 7. Documentation evidencing all payments and security for the bonds;
 8. An asset list or schedule of all bond-financed facilities or equipment;
 9. Depreciation schedules for bond-financed depreciable property; and
 10. The tracking of purchases and sales of bond-financed assets.
- M) Maintaining material records for as long as the bonds are outstanding plus three (3) years after the final redemption date of the bonds.
- N) Ensuring all County staff involved with debt issuance will be provided pertinent educational resources, enrolled in training/educational seminars and classes, and trained by knowledgeable staff to ensure compliance with all applicable Federal and State laws and regulations.

Section 7 – Types of Debt Permitted to be Issued

The County may engage in issuance of the following types of debt when circumstances, resources, and appropriate planning suggest their need and use.

7.1 Short-term Debt

- A. Bond Anticipation Notes: used to obtain interim project financing when bonds are approved but not yet issued.
- B. Grant Anticipation Notes: used to eliminate cash flow deficits associated with funding delays on State or federally funded programs.
- C. Tax and Revenue Anticipation Notes: used to eliminate cash flow deficits before receipt of taxes and other revenue in the same fiscal year.
- D. Other types of short-term debt promulgated by statute or regulatory authority that serves a beneficial public purpose (includes dry period loans).

7.2 Long-term Debt

- A. General Obligation Bonds and Limited Obligation Bonds: used for acquisition and improvements of land and buildings.
- B. Special Assessment Bonds: used for facilities of local benefit to property.
- C. Tax Allocation Bonds: used for public projects within a redevelopment project area.
- D. Certificates of Participation and Lease Revenue Bonds: use unrestricted.
- E. Revenue Bonds: used for revenue producing facilities.
- F. Taxable Bonds: Required if there is a private, non-governmental purpose of financing. Used to avoid arbitrage rebate restriction on projects with anticipated completion dates beyond three (3) years after issuance.
- G. Mello-Roos Bonds: used for community facilities development.
- H. Marks-Roos Bonds: issued by a joint power authority (JPA) to provides loans to local agencies to finance public capital improvements, working capital, and insurance programs. Voter approval is not required.
- I. Pension Obligation Bonds and Other Post-Employment Benefits (OPEB) Bonds: issued to fund the obligation to pay pension benefits and other post-employment benefits.
- J. Judgment Obligation Bonds: issued to finance legal obligations resulting from litigation.
- K. Other securitizations of County revenues: issued to obtain lump sum cash from a multi-year income stream.

Section 8 – Permitted Structural Features

- A. Maturity of the debt issued cannot exceed that permitted by law.
- B. Maturity of the debt shall not exceed the estimated useful life of the project being

constructed or improved with the proceeds of the debt, regardless of the legally permitted final maturity.

- C. Compound interest bonds (also known as zero coupon bonds or capital appreciation bonds) are sold at a deep discount from par but do not require interest or principal payments until maturity or sinking fund dates. Subject to specific structural restrictions, they are to be used for projects that will not generate sufficient revenue to permit semi-annual debt service until some time in the future. Premium bonds are those sold at a premium over par. The premium cannot exceed that permitted by law.
- D. In most cases, annual debt service will be approximately level with semi-annual interest coupons. Non-level debt service may be utilized if the structure results in a favorable financial outcome. Annual payments may be considered for multi-participant JPA or MOU financings.
- E. A mandatory redemption feature may be used on revenue bonds to call bonds with revenues produced in excess of those required to debt service. An optional call feature should be used on special assessment bonds to call bonds from proceeds of assessment prepayments.
- F. Credit enhancements, such as bond insurance or a letter of credit, are to be used if they result in an overall net debt service savings. In any event, credit enhancement is required for the use of Mello-Roos bonds in the County. A cost versus benefit analysis must be reviewed by the County Administrative Office to determine whether to purchase bond insurance or to issue bonds based on the stand-alone credit rating.
- G. Debt issues should be structured to be senior lien obligations; junior lien obligations are to be avoided due to the higher interest rate demanded by investors, but may be required dependent on the credit and structure of bond issuance.
- H. Derivative products such as interest rate swaps and hedges, while permissible, impose

additional risks. Use of derivatives must first be analyzed by the County's MA, reviewed by the DAC, and approved by the Board.

- I. If necessary for federal tax law purposes, a reimbursement resolution should be approved by the Board for qualifying capital projects that require expenditures prior to the issuance of the debt to enable those expenditures to be reimbursed in the debt issue sizing.

Section 9 – Specific Permitted Features by Type of Debt

9.1 General Obligation

General obligation bonds pursuant to State law require a two-thirds majority of those voting in a local election to authorize a bond issue for a specific purpose. They may be issued to acquire, construct, and improve real property, but cannot be used to purchase equipment or for operations and maintenance. Both competitive and negotiated sales are permissible. The bonds cannot be sold at a discount from par and the interest rate cannot be higher than the statutory limit of twelve percent (12%) nor that approved by the voters. The maximum aggregate outstanding amount of general obligation bonds may not exceed 1.25% of the assessed valuation of all real and personal property in the County, except that for water conservation and flood control projects and construction of certain County roads, the maximum may increase to 3.75%. The maximum maturity cannot exceed forty (40) years, and in no event shall it exceed the useful life of the project being financed. Annual debt service shall be approximately level. If the proceeds of the debt issue are to be used for construction of a project, the issue should be sized to include a reasonable contingency factor, depending upon the certainty of the cost of the project. An optional call feature should be included, and any funds remaining after construction of the project should be used to call outstanding bonds. A debt service reserve is not required. A credit enhancement may be employed if it reduces the overall net cost of the issue.

9.2 Revenue Obligations

Enterprise Revenue bonds are to be used to acquire or construct a specific project and are to be repaid solely from the revenue, or net revenue, produced by such enterprise. Bondholders are only entitled to repayment from such revenue or net revenue and have no recourse to the general fund. The net revenue coverage ratio (gross revenue less operations and maintenance cost) goal of 1.25 times annual debt service is desired. A debt service reserve

equal to the highest annual debt service (limited by Tax Code to 10% or proceeds) may be dictated by the market. There is no stated maximum maturity, but in no event shall it exceed the useful life of the project being financed. Annual debt service should be approximately level unless rate increases have been implemented. If the proceeds of the debt issue are to be used for construction of a project, the issue should be sized to include a reasonable contingency factor, depending upon the certainty of the cost of the project. An optional call feature should be included, and any funds remaining after construction of the project should be used to call outstanding bonds. A credit enhancement may be employed if it reduces the overall net cost of the issue. Estimated costs of issuance may be included in sizing the issue. Capitalized interest from the dated date of the bonds to six months after the anticipated completion of the project or until revenues are sufficient to pay debt service may be included in the issue sizing, as determined by the MA and/or Debt Advisory Committee (DAC).

9.3 Fixed and Variable Rate Debt

To maintain a predictable debt service burden, the County will give preference to debt that carries a fixed interest rate. An alternative to the use of fixed rate debt is floating or variable rate debt. It may be appropriate to issue short-term or long-term variable rate debt to diversify the County's debt portfolio, reduce interest costs, provide interim funding for capital projects, or improve the match of assets to liabilities.

Fixed rate debt should be considered as a primary structural tool for project financings, so that annual debt service requirements are not subject to interest rate exposure and will not vary as interest rates change. However, other forms of rate structures may be used if they result in favorable financial outcomes.

Budgetary safeguards should be in place before incurring variable rate debt, and such debt should never amount to more than twenty percent (20%) of all outstanding debt. Before incurring variable rate debt, careful consideration should be given to current market conditions and trends, including the costs and availability of Liquidity Facilities. The County's cost for administering variable rate debt should be considered when comparing fixed and variable rate debt.

Variable rate debt may be used if interest rates are high and market expectations are that rates will decline. While variable rate debt permits the County to obtain lower rates than fixed rate debt, the County is subject to interest rate

risk. The frequency with which the interest rate on the debt is reset has a direct effect on the amount of interest to be paid. Variable rate debt should only be used if the County can be converted to fixed rate debt. The County will consider the use of interest rate caps on any variable rate issue.

The use of synthetic interest rate swaps may be employed if their use is determined advisable by the County's MA, reviewed by the DAC, and approved by the Board.

9.4 Lease-backed Debt

COPs provide long-term financing through a lease or installment sale agreement that does not constitute indebtedness under the State constitutional debt limitation and are not subject to other statutory restrictions applicable to bonds, including interest rate limitation, election requirements, competitive sale requirements, or semiannual or fixed rate interest payment restrictions. COP debt was aggregated with General Obligation debt by Board of Supervisor resolution on August 16, 2005 to maximize aggregate County debt 1.25% of countywide assessed value. Rental interruption, earthquake, and other insurance should be provided. COPs shall require specific noticing for public hearings to be held for any such financing.

Lease revenue bonds are like COPs because they are both based on a lease agreement and are not subject to the constitutional debt limitation. The financed project may be revenue producing or non-revenue producing. The issuer (lessor) must lease to another public entity and receive lease payments in return that are sufficient to meet the debt service on the issue. Title must revert to the issuer after the bonds are paid in full. Lease revenue bonds cannot bear an interest rate above the legal maximum.

9.5 Special Obligation Debt

Assessment district debt may be levied to provide infrastructure improvements to defined communities of interest. Sizing of the issue may include engineering costs, legal and financing costs, and a debt service reserve. The ratio of land value to assessment lien must be at least 4 to 1 on a per parcel basis. As there is generally no obligation of the issuer to make up any delinquencies or defaults, it is necessary to provide a covenant to foreclose. Balloting for the assessment protest procedures must be in compliance with Proposition 218.

Tax allocation bonds may be issued by redevelopment agencies to revitalize blighted and economically depressed areas of the County and to promote economic growth. They

may be structured as tax-exempt bonds or federally taxable bonds. If tax increment is the sole source of repayment, it must meet a reasonable coverage test for annual debt service. The bonds must be sold by competitive sale and cannot bear an interest rate above the legal maximum. However, the bonds can be sold to the JPA at negotiated sale. Refunding bonds can be negotiated, as can housing bonds. The issue must include capitalized interest to cover the period before sufficient incremental taxes will be realized. A professional analysis of projected tax increment is required for any tax allocation bond. The County must pursue all appropriate pass-through agreements prior to debt issuance. The County may contract with a professional firm to prepare an economic feasibility determination in support of debt issuance.

9.6 Conduit Issues

Industrial development bonds may be issued under the California Industrial Development Financing Act to assist private companies in financing certain projects. Bonds issued under the Act are repaid solely by private enterprise, and no taxes or other public moneys are obligated. The maximum term is forty (40) years, the interest rate cannot exceed 12%, and they may be sold at either competitive or negotiated sale.

There are a number of federal tax law limitations and restrictions applicable to industrial development bonds.

The County may act as a conduit issuer for entities qualifying under statute for tax exempt financing when the County is expressly held harmless as documented in the bond covenants.

The County may utilize the California Statewide Communities Development Authority (CSCDA) short-term Tax and Revenue Anticipation Note (TRAN) program and affiliated long-term CaLease program when appropriate to reduce cost of issuance. The County is a member of the Authority. In addition, the County may participate in other joint powers or related agreements with public or quasi-public entities for beneficial issuance of debt instruments.

9.7 Taxable Debt

Taxable debt may be issued when facilities include private uses that exceed statutory thresholds. Taxable debt may be used when its use is determined to be structurally favorable to the overall financing. There are no arbitrage restrictions on taxable debt. There are also no restrictions as to use of the bond proceeds and on the amount of private participation. Taxable debt may be sold by competitive or negotiated sale. Taxable debt may be issued in conjunction

with tax exempt debt when economically in the best interest of the County.

9.8 New Financing Methods and Techniques

Changing federal regulations and the shifting concerns of rating agencies mean that the County operates in a dynamic financial environment. This policy is not intended to hinder the County's use of any new financing techniques that may arise.

Proposals for financing methods not included in this policy should be addressed to the DAC. If the DAC approves of such financing methods, the DAC should recommend their use to the County Administrative Office. This policy should then be amended to reflect any new financing techniques recommended by the DAC and approved by the Board.

Section 10 – Mello-Roos Debt

10.1 Local Goals and Policies

Adopted by the Board of Supervisors on March 29, 1991, the County's Mello-Roos Policy is restated and incorporated into this Debt Management Policy with only minor modifications. Section 53312.7(a) of the California Government Code required the County to consider and adopt local goals and policies concerning the use of the Mello-Roos Community Facilities Act of 1982 (the "Act"), prior to the initiation of proceeding on or after January 1, 1994 to establish a Community Facilities District (also known as Mello-Roos district) under the Act. This policy was intended to satisfy the requirements of the Act and provides specific guidance for approval of public financing for provision of public facilities and services in proposed development projects through Community Facilities Districts. In addition, this policy established the standards and guidelines for the review of these proposed development financings by County staff and its designated agent(s), the Budget Committee, and ultimately the Board. In those cases in which fixed lien special assessment or other types of land based financing is substituted for Community Facilities Districts, the County will apply applicable provisions of this policy.

10.2 Priorities for Financing

The priority that various kinds of public facilities and services will have for financing through the County's use of the Act are as follows:

- Public facilities to be owned and operated by the County that constitute regional or backbone infrastructure required to serve proposed development;

- Other public facilities (excluding in-tract infrastructure) to be owned and operated by the County for which there is a clearly demonstrated public benefit; and
- Services authorized to be financed pursuant to the Act; and
- In-tract infrastructure to be owned and operated by the County.

Generally, public facilities to be owned or operated by a public agency other than the County, including such public facilities financed in lieu of the payment of development fees imposed by such public agency, will not be financed through the County's use of the Act; provided, however, that the County may consider the financing of such facilities on a case-by-case basis. Generally, privately owned facilities (that is, facilities not owned by a local agency) will not be financed through the County's use of the Act; provided, however, that the County may consider the financing of such facilities on a case-by-case basis.

10.3 Mello-Roos Policies

- A) **Consideration of Community Facilities Districts.** The Board of Supervisors will consider the use of community facilities districts (CFDs) as well as other financing methods to assist certain types of residential, and/or nonresidential development, where, in the County's opinion, the financing of public facilities satisfies a public need and represents a significant public benefit, while having the financial security to reasonably assure a sound investment for potential bondholders and minimize any County exposure to liability for actions taken on behalf of public financing projects. Effective January 1, 2008, CFD policies must include a statement of priority for services.

While recognizing that public facilities proposed to be financed must meet a public need and must benefit properties within the proposed development project, public benefit implies that a significant public benefit will also result to the community at large. An example of significant public benefit is a public facility having regional impact such as an all-weather bridge, a freeway overpass, or a regional water or wastewater treatment plant. In respect of the foregoing, the County will give priority to the financing of backbone regional public

infrastructure improvements that produce significant public benefit. Significant public benefit can also take the form of the provision of affordable housing through reduced housing costs.

CFD financing will be permitted for public improvements that will benefit the expected long-term property owners, and whose useful life will be equal or greater than the longer of (a) five (5) years or (b) the term of the bonds.

- B) **Consistency with Comprehensive General Plan.** The proposed development project must be consistent with the County's Comprehensive General Plan and have secure appropriate land use approvals from the County to allow for the implementation of the development of the area as contemplated.
- C) **Ownership of Facilities.** Facilities which, upon completion, are to be owned, operated, or maintained by public agencies shall be considered public facilities. Limited exceptions will be made for certain facilities that are to be owned, operated, or maintained by private utilities and homeowner associations.
- D) **Appraisal.** An appraisal of the property subject to any lien required to secure any public financing shall be required. A minimum property value to lien/debt ratio of 4:1 (including any overlapping assessment or community facilities districts) must be present pursuant to Premise 3 entitled "Bulk Land Value" as set forth in Attachment A as determined by an M.A.I appraisal. The appraisal shall be reviewed by the County and shall be prepared as set forth in Attachment A hereto.
- E) **Absorption Study.** Unless waived by the County, an absorption study of the proposed development project shall be required for CFD financings. The absorption study shall be used as a basis for verification that sufficient revenues can be produced to fully and timely satisfy debt service requirements and costs of services and to determine if the financing of the public facilities and services is appropriate given the timing of the development. Additionally, the projected absorption rates

will be provided to the appraiser for use in the appraisal.

- F) **Rate and Apportionment of Special Tax.** With regard to CFDs, the proposed rate and method of apportionment of the special tax shall comply with the following criteria:
 1. The rate and method of apportionment shall not provide for an annually increasing maximum special tax for any classification. However, subject to County approval in its sole discretion, under appropriate circumstance, as determined by the County, an increase in the maximum special tax may be permitted, not to exceed two percent (2%) annually.
 2. The total projected annual special tax revenues must exceed the projected annual gross debt service on the bonds by at least ten percent (10%). In structuring the special tax, projected annual interest earnings on bond reserve funds shall not be included as revenue for the purpose of this calculation.
 3. In limited cases, as determined by the County in its sole discretion, a special tax for services may be permitted and the annual special tax may increase to reflect projected increases in costs to provide the applicable services in an amount to be determined by the County, in its sole discretion.
 4. The projected annual special tax revenues shall include amounts projected to be sufficient to pay reasonable annual administrative expenses and other direct costs to the CFD.
 5. All property not otherwise statutorily exempted or owned (or to be owned) by a public entity shall bear its appropriate share of the special tax liability.
 6. The special tax shall be apportioned on a reasonable basis to categories and

- classes of property within the CFD subject to the special tax.
7. A formula to prepay the special tax may be permitted.
 8. The projected ad valorem property tax and other direct and overlapping debt for the proposed development project (including estimated CSA charges, projected benefit assessments, levies for authorized but unissued debt and any other anticipated municipal charges which may be included in a property owners annual tax bill), including the proposed maximum special tax, may not exceed two percent (2%) of the anticipated original sales value of each improved parcel upon completion of the bond financed improvements and the reasonably anticipated private improvements. Real estate market fluctuation downward can cause the overall rate, as a percentage of sales price or appraised value, to be in excess of the two percent (2%) limitation.
 9. A backup special tax or other security device to protect against changes in densities resulting in insufficient annual special tax revenues to pay annual debt service and administrative expenses may be required at the sole discretion of the County.
- G) **Credit and Structure for Bond Issues.** Each bond issue shall be structured to adequately protect bondholders and to not negatively impact the bonding capacity or credit rating of the County through a combination of credit enhancements, foreclosure covenants, and special reserve funds. Specifically:
1. A credit enhancement will be required whenever one entity or related entities are responsible for twenty percent (20%) or more of the debt service obligation of the proposed debt issue. The required credit enhancement shall take the form of, and shall be provided as set forth in Attachment B, hereto.
2. A foreclosure covenant will be required and shall be included in any applicable bond indenture or fiscal agent agreement.
 3. The County will require that capitalized interest on the initial series of bonds be funded from proceeds of the bonds and be limited to the amount necessary to pay debt service on the bonds until the first interest payment date occurring after the levy of the special taxes on the real property tax roll. Inclusion of capitalized interest on subsequent series of bonds will be at the County's discretion and will only be permitted if a direct benefit inures to the ultimate property owners.
 4. A reserve fund equal to the lesser of ten percent (10%) of the original principal amount of the bonds, maximum annual debt service or one hundred twenty five percent (125%) of average annual debt service (Reserve Requirement) shall be funded from the proceeds of each series of bonds. A reserve fund surety bond or letter of credit, provided by a municipal bond insurer, a major banking institution or other equivalent source, may be substituted, at the County's sole discretion.
- H) **Level Debt Service Requirement.** Bond issues should be structured with approximately level debt service. To the extent that bonds are issued in series, individual series of bonds may have uneven debt service if the intent is to create level debt service at such time as all series of bonds are issued and to minimize the potential of fluctuating annual special taxes.
- I) **Maximum Term of Bonds.** If a single series of bonds is contemplated, the term of the bonds shall not, by statute, exceed forty (40) years. It is County policy to attempt to restrict such bonds to a term of thirty (30) years. If multiple series of bond issue are contemplated, in no instance should an individual residential parcel

be encumbered for debt service beyond a thirty-five (35) year period.

- J) **Disclosure.** Disclosure of the special tax lien shall be in compliance with applicable statutory authority. The County, in its sole judgment, may require additional property owner notification if it deems such disclosure will assist subsequent property owners to be made aware of the lien obligation. In addition, applicants for CFD financings and all major landowners will be required to co-operate prior to and subsequent to all bond sales with initial and continuing disclosure to bondholders and the financial markets. Applicants and landowners will cooperate in the preparation, verification, and dissemination of the identity of land owners, development project plans, timetables, and statistics, and financial pro-forma information, and any other information the County and its financing team deem appropriate.
- K) **Payment of Initial Fees and Costs by Applicant.** No proposal to initiate the formation of a CFD financing will be considered valid without the payment of a fee to compensate the County for all costs incurred to perform its analysis of the proposal and to pay for the costs of conducting the proceedings. Applicants for public financing projects shall submit proposals to the Clerk to the Board of Supervisors. The County will review the proposal within sixty (60) days after it is deemed complete and make its determination whether or not to formally consider the proposed district. The applicant(s) shall deposit a minimum \$25,000 estimated fee amount with the Clerk to the Board of Supervisors at the time the proposal is submitted. Additional deposits will be required as needed to cover costs. The minimum fee will be increased to an amount determined by the County in its sole discretion to be appropriate given the size and scope of the proposed project or financing. The estimated fee amount shall be in the form of cash or other negotiable instrument. Failure to submit any requested increase in the deposit will result in a suspension of the processing of the financing.
- L) **Independent Review by County.** The County will perform an independent review of the proposed public financing and may take recommendations to the Board regarding the financial risk, impact on the County's bonding capacity, economic feasibility and related issues. The applicant(s) shall be required to provide current and two (2) prior year financial statements, preferably audited, of the entity responsible for the development and initial payment of special taxes and other materials to assist the County or its agent in its fiscal review.
- M) **County to Select Professionals.** The County shall select the bond counsel, underwriter, financial advisor, appraiser, absorption consultant, special tax consultant and other professionals and consultants it deems appropriate. No payment from special tax or bonds will be made for property owner consultants.
- N) **Cooperation by County Departments.** All appropriate County departments will cooperate with the initiating department, the County Administrative Office and the Debt Advisory Committee (DAC) in conducting the necessary reviews and proceedings.
- O) **Limited Security for Bonds.** All statements and materials related to the sale of CFD bonds shall emphasize and state that neither the faith, credit nor the taxing power of the County is pledged to the repayment of the bonds.
- P) **County to Acquire Completed Facilities.** It is the desire of the County that it incur no liability for the design, engineering and maintenance of the public improvements to be financed through bond proceeds. It is the preference of the County to use the "acquisition district" approach to pay for CFD financed public infrastructure, under which bond proceeds will be released only upon completion of the financed improvement or approved components thereof and acceptance by the entity which is to own, operate, and maintain the improvement. All contracts for public improvements to be owned, operated or maintained by the County shall be consistent with the requirements set for the in Attachment C, hereto.

- Q) **County's Use of Financial Consultant.** The County may, at its sole discretion, employ a financial consultant to assist the County during its fiscal review period and all costs for consulting services will be borne by the applicant(s).
- R) **Disbursement of Bond Proceeds.** The financing documents will provide that bond proceeds will be used and disbursed at times and in the manner as specified in the indenture or fiscal agent agreement pursuant to which the bonds are issued.
- S) **Report in Event of Default.** For outstanding bond issues, all County departments and agencies with administrative responsibilities will notify the Board and file a written report of the circumstances if an event of default under the financing documents has occurred.
- T) **Refunding of CFD Bonds.** All proposed refunding or refinancing issues will be submitted to the County for review with complete disclosure of the benefits and costs of the proposed refinancing. A preliminary and final official statement or disclosure statement for any bonds to be refunded shall be filed with the County Treasurer-Tax Collector, County Counsel, Office of the Auditor-Controller, and Clerk of the Board of Supervisors.
- U) **Right to Modify or Waive Policies.** The County has the right to waive or modify any of the policies included herein if, in the County's judgment, benefit inures to the ultimate property owners, the CFD and/or to the County.
- problems. A detailed appraisal shall reflect nationally recognized appraisal standards, including, to the extent appropriate, the Uniform Appraisal Standards for Federal Land Acquisition. An appraisal must contain sufficient documentation, including valuation data and the appraiser's analysis of the data, to support his or her opinion of value. At a minimum, the appraisal shall contain the following items:
1. The purpose and/or the function of the appraisal; a definition of the estate being appraised, and a statement of the assumption and limiting conditions affecting the appraisal.
 2. An adequate description of the physical characteristics of the property being appraised; location, zoning, present use, and analysis of the highest and best use.
 3. All relevant and reliable approaches to value consistent with commonly accepted professional appraisal practices. If a discounted cash flow analysis is used, it should be supported with at least one other valuation method such as a market approach using sales that are at the same stage of land development. If more than one approach is utilized, there shall be an analysis and reconciliation of approaches to value that are sufficient to support the appraiser's opinion of value.
 4. A description of comparable sales, including a description of all relevant physical, legal and economic factors such as parties to the transaction, source and method of financing, and verification by a party involved in the transaction.
 5. A statement of the value of the real property.
 6. The effective date of valuation, date of appraisal, signature and certification of the appraiser.

Criteria for Appraisals

- A. **Definition of Appraisal.** An appraisal is a written statement independently and impartially prepared by a qualified appraiser setting forth an opinion of defined value of an adequately described property as of a specific date, supported by the presentation and analysis of relevant market information.
- B. **Standards of Appraisal.** The format and level of documentation for an appraisal depend on the complexity of the appraisal problem. A detailed appraisal shall be prepared for complex appraisal
- C. **Conflict of Interest.** No appraiser or review appraiser shall have any interest direct or indirect in the real property being appraised for the Agency that would in any way conflict with the preparation or review of the appraisal. Compensation for making the appraisal shall not be based on the amount of valuation.
- D. **Community Facilities District Appraisal Premises.** The valuation of proposed special tax districts should be based on three premises:

1. Raw Land Value. (Premise #1). The total land within the project is valued “as is”:
 - a. Without any existing infrastructure.
 - b. Without proposed infrastructure being financed.
 - c. With existing parcel configuration.
 - d. Considering planned densities allowed by the specific plan of the project.

This is a typical type of land valuation.

2. Project Build-out Value. (Premise #2). The total land within the project is valued under projected conditions:
 - a. With proposed infrastructure being financed completed.
 - b. At the planned densities allowed by the specific plan.
 - c. Land development is at the stage of being marketed to merchant builders or tentative tract maps ready to be filed.

This is a projected value based on project plans predicated on market conditions continuing as projected.

3. Bulk Land Value. (Premise #3). The total land within the project is valued under projected conditions:
 - a. With proposed infrastructure being financed completed.
 - b. With existing parcel configuration.
 - c. Considering planned densities allowed by the specific plan of the project.

This premise should consider a discounted or “quick sale” valuation considering time, costs, and the possibility of a per unit value based on the total size of the project.

said property owner or owners, pay interest thereon through redemption, bond call premiums and an associated costs and penalties when the property owner or owners are deemed to be in default under the terms of the required contractual agreement between the property owner or owners and the County for payment of annual assessed special taxes.

- C. The terms of the agreement with the bank providing the Letter of Credit shall require the bank to provide sixty (60) days notice of termination or expiration for any cause to the County, and permit, if fifteen (15) days prior to expiration no replacement or renewal Letter of Credit is in place that will be in effect upon the expiration date, the County to draw upon the Letter of Credit and call and redeem the allocable bonds, pay interest thereon through redemption, call premiums and any associated costs and penalties.

- D. The Letter of Credit is to be in an amount equal to 110% of the gross principal amount of the bonds allocable to the said property owner or owners plus an amount sufficient to pay the maximum accrued interest and bond premium, if any, through call and redemption of the allocable bonds in event of default in payment of special tax by said property owner or owners. The Letter of Credit shall be in force and renewed continuously for a period beginning on the date before the delivery of the bonds and continuing until such time as the said property owner or owners annual tax liability falls below ten percent (10%) of the gross annual special tax being levied within the boundaries of the proposed District. The amount of the Letter of Credit may be reduced on an annual basis, commencing on the anniversary date of the day prior to delivery of the bonds as the aforementioned property owner or owners sell portions of their property.

- E. The Letter of Credit must be issued by a financial institution acceptable to the County, the long term unsecured obligations of which are rated at least “single-A” or better by a NRSRO.

- F. “Property owner or owners” as used here shall mean owners at the time of commencement of the CFD, owners owned or controlled by said owner or any related owners and any successor property owner.

Policy on Credit Enhancement

- A. With regard to formation of a Community Facilities District pursuant to the Mello-Roos community Facilities Act of 1982, as amended, if a property owner or owners would be responsible for ten percent (10%) or more of the total annual special tax to be levied within the proposed boundaries of the District, then said property owner or owners will be required to provide a Letter of Credit naming the County of Monterey as beneficiary.
- B. The Letter of Credit will be drawn down by the County to call and redeem all bonds allocable to

Construction Contracts for Community Facilities Within Mello-Roos Districts

payment of 10% or more of the total annual special tax to be levied for any fiscal year.

With regard to the construction of public facilities that are to be financed from the proceeds of bonds sold pursuant to the Mello-Roos Community Facilities Act of 1982, as amended, (commencing with Section 53311 et seq. of the Government Code) (the "Act") the following policies are to be applied:

- A. The appropriate County department will be specified as the District's representative to administer the construction of each of the facilities to be owned and maintained by the County.
- B. The facilities to be owned and maintained by the County are to be constructed and/or acquired, by the District.
- C. Consistent with this policy, the County finds, pursuant to Section 53329.5(c) of the Act, that it will not serve the public interest to allow the property owners to elect to perform the construction of the facilities after the publication of the notice of the award of the contract and declaration to this effect is to be included in each resolution of intention submitted to the Board of Supervisors pursuant to Section 53321.

Required Basic Contractual Terms

Prior to delivery of the bonds, property owner or owners agree for timely payment of all annual assessed special taxes to the property owner or owners or its successors. An agreement will specify that a required Letter of Credit will be liquidated and applied to payment of the bonds via bond call provisions specified in the bond indenture in the event of default by the property owner or owners or its successors.

A default condition is defined as any installment (Section 2605 et seq. Revenue and Taxation Code) of property taxes where a lien for Mello-Roos assessments attaches to some installment and where such installment remains unpaid as of 5:00 p.m. on the delinquent date established for a tax installment (normally December 10 and April 10).

The agreement shall remain in full force and effect, and will be binding upon the property owner or owners or its successors in fee title as long as the property owner or owners (as defined by County Policy on Credit Enhancement) or its successors are responsible for

Annual Work Program for Road Fund

California Code of Regulations Section 994 - Road Construction and Maintenance Activity, and Streets and Highways Code, Chapter 2, Article 4 require that a Road Fund Budget be submitted to the Board of Supervisors in the form and manner prescribed by the State Controller at the same time as other county departments submit their recommended budgets. In accordance with CCC Section 994, the below tables contains the Public Works Annual Work Program for the Road Fund (Fund 002, Units 8558) for Fiscal Year 2023-24.

PROJECT NO.	ACTIVITY/PROJECT	Unit 8558 Road & Bridge	FY24 Total
ADMINISTRATION, GENERAL ENGINEERING, AND EQUIPMENT			
0400	Public Works - Maintenance Administration	1,335,503	1,335,503
0500	Public Works - Roads Administration	3,265,461	3,265,461
0700	General Engineering, Traffic Engineering	1,476,974	1,476,974
9000	Vehicle & Equipment Acquisition	2,407,150	2,407,150
Total	Total Administration, General Engineering and Equipment	8,485,088	8,485,088
NON-ROAD REIMBURSABLE WORK			
8100	County Service Area Support	98,025	98,025
8300	County Sanitation District Support	45,324	45,324
8652	Litter Control	236,850	236,850
8655	Adopt a Roadway Program (Litter)	1,171	1,171
8734	Carmel Lagoon Sandbar management and Flood Prevention	175,000	175,000
PWOTH	Public Works-Support to other units	683,328	683,328
Total	Total Non-Road Reimbursable Work	1,239,698	1,239,698
ROAD & BRIDGE MAINTENANCE			
5000	Traffic Signals	270,862	270,862
5003	Engineering related to Bridge Maintenance	93,019	93,019
5100	Road Maintenance District 1 - San Miguel	2,271,537	2,271,537
5200	Road Maintenance District 2 - Monterey	3,983,045	3,983,045
5300	Road Maintenance District 3 - Greenfield	2,235,403	2,235,403
5400	Road Maintenance District 4 - San Ardo	2,072,497	2,072,497
5500	Pavement Management Seal Coat	2,000,000	2,000,000
5600	Bridge Maintenance	2,016,751	2,016,751
5800	Maintenance - Traffic	987,236	987,236
3044	Operational Contingencies/Strategic Reserve	4,000,000	4,000,000
Total	Total Maintenance	19,930,350	19,930,350
ROAD CONSTRUCTION PROJECTS			
1146	Laureles Grade Rd/Carmel Valley Rd Roundabout <i>Continue Preliminary Design Phases of project.</i>	2,050,000	2,050,000
1155	Elkhorn Road Rehab <i>Continue Preliminary Design Phases of project.</i>	660,000	660,000
1156	Intergarrison Road Resurfacing <i>Complete Construction Phase.</i>	545,000	545,000
1159	Old Stage Road Rehab Alisal Road to Iverson Road <i>Continue Preliminary Design Phases of project.</i>	538,571	538,571
1172	Hunter Lane Reconstruction <i>Complete Construction Phase.</i>	5,460,000	5,460,000
1175	Salinas and Pajaro Road <i>Initiate Preliminary Design Phases of project.</i>	79,400	79,400
1176	Prunedale Roundabout <i>Initiate Preliminary Design Phases of project.</i>	280,500	280,500
1577	Alisal Road Rehab. (Salinas to Hartnell Rd) <i>Continue Preliminary Design Phases of project.</i>	4,985,000	4,985,000
2202	Nacimiento Lake Drive Bridge #449 <i>Complete Construction Phase.</i>	1,939,860	1,939,860
3600	Davis Road Bridge #208 and Four Lane Road <i>Complete Right of Way Phase and initiate Construction Phase.</i>	1,855,737	1,855,737
3851	Robinson Canyon Road Bridge Scour Repair <i>Complete Construction Phase.</i>	688,458	688,458
3852	Bradley Road Bridge Scour Repair <i>Complete Construction Phase.</i>	423,715	423,715

California Code of Regulations Section 994 - Road Construction and Maintenance Activity, and Streets and Highways Code, Chapter 2, Article 4 require that a Road Fund Budget be submitted to the Board of Supervisors in the form and manner prescribed by the State Controller at the same time as other county departments submit their recommended budgets. In accordance with CCC Section 994, the below tables contains the Public Works Annual Work Program for the Road Fund (Fund 002, Units 8558) for Fiscal Year 2023-24.

PROJECT NO.	ACTIVITY/PROJECT	Unit 8558 Road & Bridge	FY24 Total
3853	Gonzales River Road Bridge Superstructure Replacement <i>Continue Preliminary Design Phases of project.</i>	535,000	535,000
3854	Hartnell Road Bridge Replacement <i>Complete Construction Phase.</i>	121,000	121,000
3856	Countywide Striping Phase III <i>Complete Construction Phase.</i>	600,000	600,000
3857	Monte Road Bridge 135-Paint Steel Girders <i>Initiate Preliminary Design Phases of project.</i>	90,572	90,572
3860	Chular Canyon Road Four Bridge Replacement <i>Continue Preliminary Design Phases of project.</i>	302,186	302,186
4000	Community Pavement Program <i>Continue Design and Construction Phases of project.</i>	8,629,332	8,629,332
621082	Toro Road Repair <i>Complete Construction Phase.</i>	550,000	550,000
621095C	Viejo Road Slope Repair <i>Complete Design Phase and initiate Construction Phase.</i>	829,846	829,846
621071	Palo Colorado MP 4.0 to MP 7.8 Emergency <i>Continue Design Phases of project.</i>	2,987,000	2,987,000
723114	Atmospheric River December Event-Lewis Creek <i>Complete Construction Phase.</i>	750,000	750,000
723109	Atmospheric River December Event-North Fork <i>Complete Construction Phase.</i>	50,000	50,000
PW2021-4	G-12 Pajaro to Prunedale Corridor Study - Segment 2 <i>Continue Preliminary Design Phases of project.</i>	50,094	50,094
PW2021-5	G-12 Pajaro to Prunedale Corridor Study - Segment 3 <i>Continue Preliminary Design Phases of project.</i>	60,712	60,712
PW2021-6	G-12 Pajaro to Prunedale Corridor Study - Segment 4 <i>Continue Preliminary Design Phases of project.</i>	28,187	28,187
PW2021-7	G-12 Pajaro to Prunedale Corridor Study - Segment 5 <i>Continue Preliminary Design Phases of project.</i>	62,568	62,568
PW2024-12	Chular Safe Route to School <i>Continue Preliminary Design Phases of project.</i>	169,400	169,400
PW2024-13	Castroville Safe Route to School <i>Continue Preliminary Design Phases of project.</i>	262,500	262,500
PW2024-14	San Ardo Safe Route to School <i>Continue Preliminary Design Phases of project.</i>	61,500	61,500
PW2024-15	Bridge Preventative Maintenance Program <i>Continue Preliminary Design Phases of project.</i>	1,837,090	1,837,090
PW2024-16	Area 2 Roundabout @ Strawberry/Echo Valley/Garlen Lane Intersections <i>Continue Preliminary Design Phases of project.</i>	662,625	662,625
PW2024-17	Area 3 Class I Bike Lane <i>Continue Preliminary Design Phases of project.</i>	126,765	126,765
PW2024-18	Area 5 Roundabout @ Salinas Road, Elkhorn, Werner Intersection <i>Continue Preliminary Design Phases of project.</i>	771,840	771,840
5101	Community Road Maintenance Program <i>Initiate Construction Phase</i>	1,452,394	1,452,394
1150	Blackie Road Safety Improvement Environmental Mitigation <i>Complete Mitigation Phase</i>	240,000	240,000
1151	Blackie Road Extension <i>Continue Preliminary Design Phases of project.</i>	135,000	135,000
115300	Guardrail Repair Program <i>Initiate Preliminary Design Phases of project.</i>	550,000	550,000
1163	Vegetation Removal Yearly <i>Complete vegetation and removal</i>	150,000	150,000

California Code of Regulations Section 994 - Road Construction and Maintenance Activity, and Streets and Highways Code, Chapter 2, Article 4 require that a Road Fund Budget be submitted to the Board of Supervisors in the form and manner prescribed by the State Controller at the same time as other county departments submit their recommended budgets. In accordance with CCC Section 994, the below tables contains the Public Works Annual Work Program for the Road Fund (Fund 002, Units 8558) for Fiscal Year 2023-24.

PROJECT NO.	ACTIVITY/PROJECT	Unit 8558 Road & Bridge	FY24 Total
5900	NPDES Street Sweeping <i>National Pollution Discharge Elimination System that is required by the State of California to keep roadways clean of debris</i>	180,000	180,000
8667	Las Lomas Drive Bike and Pedestrian <i>Complete Construction Phase.</i>	2,890,000	2,890,000
8875	Proactive Drainage Maintenance & Flood Prevention <i>Proactively permitting and completing necessary maintenance work along flood prone drainage areas</i>	500,000	500,000
PW2024-11	Community Street Repair (Various Locations) <i>Initiate Design and Construction Phases of project.</i>	1,400,000	1,400,000
Total	Total Road Projects	46,541,852	46,541,852
Total	Total FY 2023-24 Work Program, Road Fund - Fund 002	76,196,989	76,196,989



This page intentionally left blank.

Budget Development Process

The County’s annual budget development process consists of five stages: 1) Budget Initiation; 2) Forecast; 3) Budget Development; 4) Budget Adoption; and 5) Budget Management. Departments began their financial planning at mid-year, with development of a detailed financial forecast. Departments use the financial forecast to estimate future levels of services that can be afforded with their program revenue and general fund contributions (GFC). General fund contributions are “non-departmental” monies allocated at the discretion of the Board to supplement a department’s program-specific revenues (federal or State allotments, service charges, etc.). The majority of departments rely on GFC at some level to provide services and use their forecasts to plan capacity for funding future years’ services. The County Administrative Office (CAO) presented details of the forecast to the Board at its March 7, 2023, meeting.

Following the forecast, departments submitted their requested budgets for the next fiscal year. These requests included two parts: baseline spending plans and augmentation requests. Baseline requests represent departments’ proposed plan for carrying out operations for next fiscal year within the constraints of its expected revenue and GFC. The CAO reviewed and prioritized requests based on the substantiation of benefits, alignment with Board priorities, and opportunities for leveraging existing or new resources. The CAO held workshops with Department Heads and the Board to communicate fiscal challenges shaping next year’s budget. The CAO then incorporated direction from the Board and built a comprehensive, rational, and balanced spending plan for the coming year. This plan will be presented to the Board at the annual Budget Hearings on May 31 and June 1, with adoption on June 22. Detailed budget development dates can be found in the County’s Budget and Reporting Development Schedule.

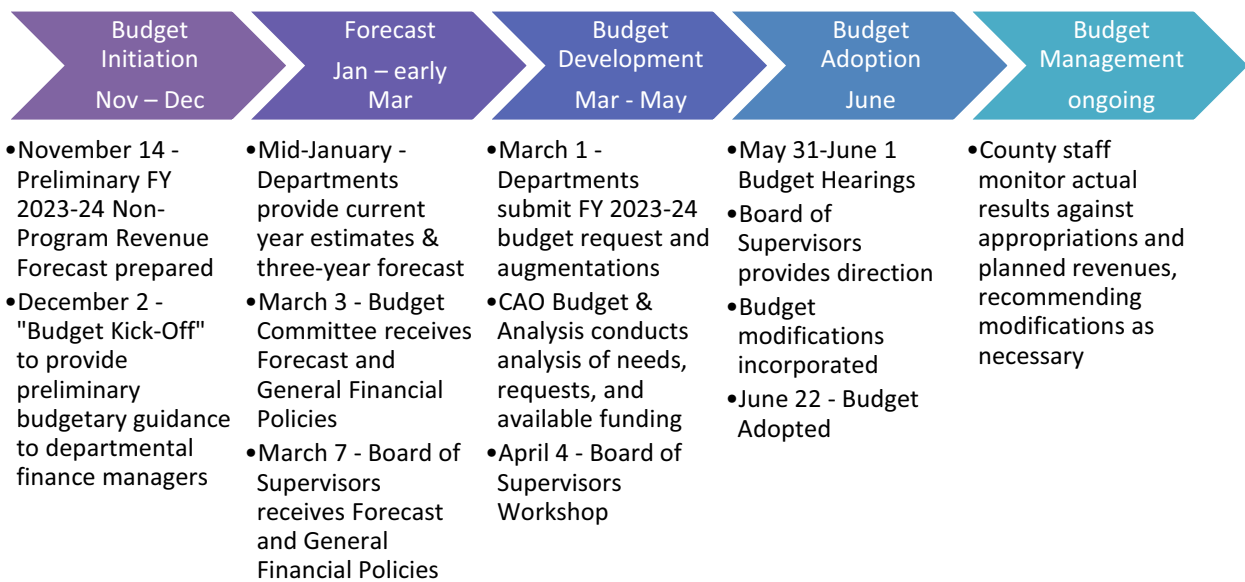



This page intentionally left blank.

Budget Reporting and Development Schedule

Budget Development Schedule FY 2023-24

PLEASE NOTE: This schedule is subject to change.

	Date	Task/Issue	Lead
SEPTEMBER 2022	19	CAO-Budget & Analysis initiates review of FY 2022-23 year-end results for preparation of Budget End of Year Report (BEYR).	CAO B&A
	20	CAO-Budget & Analysis distribute the FY 2023-24 Budget Development Schedule to all departments (SharePoint).	CAO B&A
	20	CAO-Budget & Analysis distribute the FY 2023-24 Request for Change to Organization Structure form (SharePoint).	CAO B&A
	23	Information Technology and customer departments begin discussions for FY 2022-23 technology and telecom service needs and related charges.	ITD
	30	Budget Committee Special Meeting - (11:00 a.m. - Monterey Room)	CAO B&A
	30	Deadline: Departments submit narratives for BEYR.*	CAO B&A
OCTOBER	17	Deadline: HR & Payroll to provide MOU details for approved changes (if any) e.g. pay differentials, salary increases, etc.	Central HR/Payroll
	17	Charging departments (ERP, Fleet, Mail Svcs., Facilities, Risk, Benefits, Health, etc.) begin review of FY 2022-23 year-end and FY 2023-24 services/costs, including Indirect Costs (COWCAP).	ITD, PFWP, ACO ERP, Gen'l Acctg.
	26	Budget Committee Meeting - receives Budget End of Year Report (BEYR).	CAO B&A
	26	Review of HRM report, MC-HRM-POSN-0039 Authorized Position, correction/cleanup as needed to match authorized position with employee and FTE counts; match BOS Adopted/Current Year BOS approved position updates.	HR & Finance - All Depts
	28	Deadline: Departments submit FY 2023-24 Request for Change to Organization Structure form(s) to CAO Analysts.	Requesting Depts
	28	Deadline: Risk Mgmt. distributes FY 2022-23 (update) & FY 2023-24 cost allocations/assumptions for Gen'l Liab., Work Comp, Other Insurance (for PB programming & Three-Year Forecast).	Risk Mgmt
	28	Deadline: HR-Benefits distributes FY 2022-23 (update) & FY 2023-24 cost allocation changes/assumptions for PERS retirement, OPEB, Med/Dental, etc. (for PB programming & Three-Year Forecast).	Central HR - Benefits
	28	Deadline: Health distributes FY 2023-24 Wellness Program cost changes/assumptions for non-general fund budget units.	Health - Wellness
NOVEMBER	14	CAO-Budget & Analysis prepares preliminary FY 2023-24 Non-Program Revenues Forecast.	CAO B&A
	14	Confirmation of PB security assignment by all departments.	CAO B&A & ACO ERP
	15	Board of Supervisors Meeting - receives Budget End of Year Report (BEYR).	CAO B&A
	18	CAO-Budget & Analysis publishes approved FY 2023-24 Request to Change to Organization Structure (SharePoint).	CAO B&A
	23	Review of HRM report, MC-HRM-POSN-0039 Authorized Positions, correction/cleanup as needed to match authorized position with employee and FTE counts; match BOS Adopted/Current Year BOS approved position updates.	HR & Finance - All Depts
	23	Departments submit and review new & reallocated positions in HRM before 1st HRM to PB Load.	HR & Finance - All Depts
	30	Budget Committee meeting - (1:30 p.m. - Monterey Room)	CAO B&A
DECEMBER	2	FY 2023-24 Budget Development kick-off meeting (9:00 a.m. - Monterey Room)	All Depts
	2	CAO-Budget & Analysis distributes financial assumptions for development of the FY 2022-23 Three-Year Forecast.	CAO B&A
	2	CAO-Budget & Analysis issues preliminary budget baseline funding approach/General Fund Contribution (GFC).	CAO B&A
	2	Issue Capital Improvement Program (CIP) Call for Project Updates to all departments.	PWFP - All Depts
	7	1st PB HRM to PB Load & FIN to PB Load.	ACO ERP, HR
	15	PB Open for Year-End Estimates & Three-Year Forecast data entry.	CAO B&A
	15-16	PB training for PB functionality, Year-End Estimate, and Three-year Forecast data entry.	CAO B&A
	20	Deadline: Auditor-Controller's Office publishes FY 2023-24 COWCAP plan draft.	ACO
	29-30	PB Year-End Estimate/Three-Year Forecast Labs.	CAO B&A
	JANUARY 2023	3	Review of HRM report, MC-HRM-POSN-0039 Authorized Position, correction/cleanup as needed to match authorized position with employee and FTE counts; match BOS Adopted/Current Year BOS approved position updates.
3		Deadline: Service departments issue FY 2022-23 Year-end Estimate (if applicable) and FY 2023-24 charges to customer departments (I.T., telecom, records retention, vehicle mtc, fleet mgmt, courier/mail svcs., ERP, etc.).	Info Tech, RMA, Auditor
4		Deadline: Depts submit HRM PSMT (position changes) to Central HR.	HR Analysts - All Depts
4		Deadline: Depts finalize Year-End Estimate and Three-Year Forecast data entry in PB.	All Depts
4		Depts to have all new and reallocated positions finalized before 2nd HRM to PB Load.	HR & Finance - All Depts
4		B&A Analysts begin review/analysis of Year-End Estimates, Three-Year Forecast, fund balance, mid-year cost adjustments, etc.	CAO B&A
6		Departments review FY 2023-24 Proposed State Budget.	All Depts
6		Deadline: Other Fund departments submit year-end estimated fund balance, cancellations & provisions to obligated fund balance.	Fund Mgrs, FMs
9		Deadline: Depts submit narrative to CAO B&A regarding proposed State Budget Impacts.	All Depts
9		CAO B&A issues memo advising departments of "BLACKOUT" dates and related Board Report language.	CAO B&A
11		State Budget Impacts Board Report to begin workflow through Legistar for BoS mtg.	CAO B&A
20		2nd HRM to PB Load, PB closed for baseline preparation.	ACO ERP, HR

**Budget Development Schedule
FY 2023-24**

PLEASE NOTE: This schedule is subject to change.

Date	Task/Issue	Lead
JANUARY	20 Deadline: CAO Analysts finalize Year-End Estimates and Three-Year Forecast data entry in PB.	CAO B&A
	20 Deadline: Departments enter capital project updates into the CIP Database.	All Depts
	25 Budget Committee Meeting - receives State Budget Impacts report.	CAO B&A
	27 Open PB for Baseline Budget data entry.	ACO ERP, HR
	27 Deadline: Depts. submit narratives for Three-Year Forecast.*	CAO B&A
	27 Deadline: Departments submit pictures to CAO B&A for the FY 2023-24 Recommended Budget Book.	All Depts
	27 Deadline: Departments submit Requests to Classify (RTC) forms for FY 2023-24 new or reallocated positions to Central HR for approval.	HR Analysts - Applicable Depts
FEBRUARY	1 Departments run MC-PB-SBFS-4301/MC-PB-SBFS-4305/MC-PB-SBFS-4306 reports, verify correct position data transferred from HRM.	HR & Finance - All Depts
	1-3 PB training for Budget Development 'Baseline' and Budget Augmentations.	CAO B&A
	7 Board of Supervisors Meeting - receives State Budget Impacts report.	CAO B&A
	7 Deadline: LDPC (HRM Labor Distribution Profile Codes) Requests to add/delete/update due to ERP for FY 2023-24.	HR & Finance - All Depts
	8 FY 2022-23 Three-Year Forecast & General Financial Policies begins Legistar workflow for BC & BoS mtg.	CAO B&A
	10 Deadline: Submit all HR-reviewed/approved RTCs for new or revised positions to CAO Budget & Analysis.	Dept HR, Central HR
	10 Deadline: Departments submit Performance Measures for Recommended Budget Book to CAO Budget & Analysis.	All Depts
	20 Complete input of all Board approved positions for the current year (from the 2nd HRM load thru March 31, 2023) in HRM.	Central HR/Dept HR Analysts/CAO
	22-24 PB Budget Development Baseline and Budget Augmentations Labs.	CAO B&A
	22 Review of HRM report, MC-HRM-POSN-0039 Authorized Position vs MC-PB-SBFS-4305/MC-PB-SBFS-4306 to compare and verify Current Year Allocations to continue for FY 2023.	HR & Finance - All Depts
	22 Deadline: CAO B&A review Request to Classify (RTC) forms/follow up as needed.	CAO B&A, HR, Depts
	22 BLACKOUT: Last day for position changes (new/reallocations) until adoption of FY 2023-24 Budget.	CAO B&A, HR, All Depts.
22 Budget Committee Meeting - receives Three-Year Forecast & General Financial Policies.	CAO B&A	
22-24 Depts. review requested positions; update info as needed; confirm current position info (position code/count).	DHs/ FMs & HR	
MARCH	1 Deadline: Departments finalize FY 2023-24 baseline and budget augmentation requests in PB. Confirm positions; include related approved RTCs as attachments.	All Depts/FMs
	2 PB Requested Budget/Stage 1 closed.	ACO ERP, CAO B&A
	7 Board of Supervisors Meeting - receives Three-Year Forecast & General Financial Policies.	CAO B&A
	10 CAO Analysts complete preliminary data entry in PB for FY 2023-24 Recommended Budget.	CAO B&A
	10 Recommendation from Budget Director to CAO on available fund balance and budget augmentations.	CAO B&A
	13 Capital Committee Meeting - (1:30 p.m. - Monterey Room) - PWWP presents Draft CIP, unfunded CIP projects.	CAO B&A/PWWP
	14 Deadline: Other Fund Departments submit revised fund balance and cancellations and provisions for reserves/designations, if appropriate, for year-end estimate and requested budget.	Fund Mgrs, FMs
	23 Recommended Budget Book - Budget Narratives Training and Lab.	CAO B&A
	24 Department Heads Budget Workshop - Place TBD - 9:00 a.m. - 4:00 p.m.	CAO B&A
	27 Board Report on Status on the Development of FY 2023-24 Recommended Budget begins Legistar workflow (for Special Budget Workshop of the Board on 4/4/23 - date subject to change).	CAO B&A
29 Budget Committee Meeting - (1:30 p.m. - Monterey Room).	CAO B&A	
31 Deadline: Departments update CAO Analysts on significant changes to year-end estimate based on third quarter actuals.	Applicable Depts	
APRIL	4 CAO Analysts make final adjustments to PB FY 2022-23 Year-end Estimate, if material, based on third quarter estimates.	CAO B&A
	4 Special Meeting of the Board of Supervisors - Budget Workshop on the Status on the Development of the Recommended Budget - Board Chambers - 9:00 a.m. - 4:00 p.m. (or 1:30 p.m. - 4:00 p.m.).	CAO B&A
	6 Preliminary confirmation to departments regarding FY 2023-24 recommended budget augmentation requests.	CAO
	6 Individual DH meetings w/CAO if appealing FY 2023-24 recommendations.	CAO - DHs
	10 Deadline: Departments finalize Requested Budget narratives, including recommended budget augmentation requests.	All Depts
	10 Communicate Layoff Positions to Budget Analyst and Central HR.	HR & Finance - All Depts
	10 Inform Central HR if extension is needed for filled Allocation on Loan Positions.	HR & Finance - All Depts
	10 CAO Analysts revise Recommended Budget and Recommended Budget Book narratives, third-quarter year-end estimate changes, and BoS approved budget modifications.	CAO B&A
10 Verify balanced FY 2023-24 Recommended Budget.	CAO B&A	

**Budget Development Schedule
FY 2023-24**

PLEASE NOTE: This schedule is subject to change.

	Date	Task/Issue	Lead
APRIL	10	Create PB to HRM "Draft" position worksheet for departments to review/confirm.	ACO - ERP
	4/12-5/2	Departments review "draft" position worksheet and confirm all positions, transfers, reorgs, reallocations, deletions, etc.	HR & Finance - All Depts
	14	CAO and Auditor-Controller review Year-end Estimated Fund Balance, Cancellations, & Reserves.	CAO B&A
	26	Budget Committee Meeting (1:30 p.m. - Monterey Room).	CAO B&A
MAY	3	Deadline: Dept. HR and finance sign off "Draft" PB to HRM position spreadsheet to Auditor's Office.	HR/Finance/All Depts
	3	Deadline: All Advantage HRM transactions to reflect positions in PB have been workflowed through CAO B&A and HR.	All Depts
	5	Auditor-Controller's Office provides Gann Limit information and Schedules for Recommended Budget Book.	CAO B&A & Auditor
	5	Prepare Notice to Taxpayers to publish by 5/18 (10 days before Public Hearings).	CAO B&A
	11	FY 2023-24 Recommended Budget goes to print.	CAO B&A
	11	FY 2023-24 Recommended Budget Summary Report(s) due in Legistar workflow (for BC).	CAO B&A
	12	Begin preparing "Adopted Budget" Board Reports for all agencies in Legistar, to be finalized immediately following Budget Hearings.	CAO B&A
	19	FY 2023-24 Recommended Budget available for review by public & departments.	CAO B&A
	24	Budget Committee Meeting - receives FY 2023-24 Recommended Budget Summary. (*Special meeting)	CAO B&A
	25	BoS - FY 2023-24 Recommended Budget Agenda(s) posted (for 5/31-6/1 hearings).	CAO B&A
	31	FY 2023-24 Recommended Budget Hearings (5/31 & 6/1, date subject to change).	CAO B&A
	JUNE	1	FY 2023-24 Recommended Budget Hearings (5/31 & 6/1, date subject to change).
5		Deadline: Submit detailed worksheet to Central HR and A/C-ERP for any position changes directed by Board at Budget Hearings.	CAO B&A
5-6		Reconciliation and tabulation of position changes made during Budget Hearings.	Central HR/ACO ERP/CAO B&A
5-6		Verify necessary position and budget changes based on Budget Hearing actions by the Board, for PB data entry and preparation of Adopted Budget Resolution.	CAO B&A
6		Create PB to HRM "final" position spreadsheet for departmental review/verification.	ACO ERP, Central HR
5-7		Prepare worksheets to identify Budget Hearing changes to Recommended Budget, detailed by Fund, Dept, Unit, line item for revenue, expenditures, for data entry in PB and SBFS revisions.	CAO B&A
5-7		Final "Adopted Budget" changes data entry in PB for all accounting details by department, all position changes in SBFS, verify through FSQs and Advantage reports PB Stage 3 .	CAO B&A
5-12		Finalize and workflow 9+/- individual Board Reports in Legistar for adoption of FY 2023-24 Budgets for all Board of Supervisors governed agencies and special districts (for 6/20/23 BoS mtg.)	CAO B&A
22		Board of Supervisors Meeting - Adoption of FY 2023-24 Budget.	CAO B&A
21		Deadline: Position (PSMT) draft documents and employee (ESMT) draft documents updated and review completed. Dept. HR and finance sign off on position and employee documents to Auditor's office.	HR & Finance - All Depts
21		Load PB to HRM "Final" position spreadsheet to HRM as draft documents.	ACO ERP
21		Load ESMT to HRM as draft documents.	ACO ERP
19-22		PB approved FY 2022-23 budget data moved to FIN Advantage.	ACO ERP
21-23		Position (PSMT) - Position Authorization (PAMT) - Employee (ESMT) documents finalized.	ACO ERP
22-27		Department verification of budgets in FIN Advantage, Expense/Revenue query pages (MC-FIN-BA-0200/0201), Expense vs Budget/Revenue vs Budget.	Finance Staff/All Depts
28	Budget Committee Meeting - (1:30 p.m. - Monterey Room).	CAO B&A	
JULY	3	Departments compare FY 2023-24 Adopted Budget to HRM report (MC-HRM-POSN-0039) authorized positions to verify position and FTE counts.	HR & Finance - All Depts
	3	Departments verify positions finalize manual entries to HRM with Central HR coordination when discrepancies found in authorized positions & FTE counts and employees.	HR & Finance - All Depts, Central HR

* Departments should submit narratives for their General Fund operations and, if applicable, for the following major funds: NMC, Road Fund, Library Fund, Behavioral Health Fund, Local Revenue Fund 2011, Health & Welfare Realignment Fund, and Parks & Lake Resorts operations, Emergency Communications.

Budget Reporting and Development
Schedule



This page intentionally left blank.

Glossary of Terms

ACCOUNT

An account is a classification of activity. Example: “Office Expense” is an account in the overall category “Services and Supplies.”

ADOPTED BUDGET

The approved plan for funding sources and uses (estimated revenues, unreserved fund balance and appropriations) for a fiscal year. Also referenced as “Final Budget.”

APPROPRIATION

An appropriation is the Board of Supervisors’ authorization to make expenditures and to incur obligations for specific purposes. An appropriation expires at fiscal year-end.

ASSESSED VALUATION

A value established for real estate or other property by the County Assessor or the State Board of Equalization as a basis for levying taxes.

ASSIGNED FUNDS

Amounts constrained by the government’s *intent* to be used for a specific purpose, but are neither restricted nor committed. Intent is expressed by the governing body itself, or a body (a budget or finance committee) or official to which the governing body has delegated the authority to assign amounts. Assignment is not required to be the government’s highest level of decision-making authority and the nature of the action to remove or modify assignments are not as strict.

AUTHORIZED POSITIONS

Personnel positions approved by the Board of Supervisors which may or may not be funded (see Budgeted Positions).

AVAILABLE FINANCING

All the means of financing a budget, primarily fund balance and estimated revenues including proceeds of property taxes. Does not include encumbered reserves, reserves or designations.

BALANCED BUDGET

Statutorily Balanced: When total estimated financing sources (beginning fund balance plus revenues) equal the total appropriation (expenditures plus ending fund balance). Spending in a given year does not exceed total current revenues plus any Fund Balance carryover from the prior year.

Structurally Balanced: The budget matches total ongoing expenditures to the annual estimated

revenues. In a structurally balanced budget, beginning fund balance may “not” be used as a financing source for ongoing expenditures.

BUDGET

A budget is a document listing appropriations and estimated revenues for a fiscal year.

BUDGET UNIT

A budget unit is the smallest entity for which the Board of Supervisors approves an appropriation. A department may have one or more budget units. Each budget unit has a number of accounts.

BUDGETED POSITIONS

The number of full-time equivalent (FTE) personnel positions funded in a budget. Budgeted positions should not be confused with “authorized” positions, which are positions that may or may not be funded.

CAPITAL ASSET

A capital asset is a tangible or intangible item with a life beyond one year, such as land, buildings, furniture, and equipment, with a unit cost in excess of \$5,000.

CAPITAL PROJECTS

Capital projects are proposed acquisitions, additions, and improvements to capital assets, e.g., buildings, building improvements, and land purchases subject to the County’s Capitalization Policy.

CERTIFICATES OF PARTICIPATION

A form of financing by government entities which allows an individual to buy a share of the lease revenue of an agreement made by these entities.

CJIS/SUSTAIN

Integration of the Criminal Justice Information System with the State Court’s System (SUSTAIN).

COMMITTED FUNDS

Constraints on use of these funds are imposed by formal action of the government’s highest level of decision-making authority. Constraints can only be removed or changed by taking the same type of action it employed to commit those amounts, i.e. legislation, resolution, or ordinance.

CONTINGENCIES

Contingencies are an amount set-aside in the budget for unforeseen expenditure requirements. The Contingencies must be appropriated by the Board and is subject to a 4/5ths vote.

COBRA

Consolidated Budget Reconciliation Act of 1985. Refers specifically to Title X of the Act, which included provisions to provide members of company health plans who have lost their coverage due to a "qualifying event" to continue coverage at the employee's expense for a period of time.

COST PLAN

Cost Allocation Plan is known as OMB Circular A-87. This is a document that identifies, accumulates, and distributes allowable direct and indirect costs under grants and contracts and identifies the allocation methods used for distribution.

DEBT SERVICE

Debt Service is an obligation to pay principal and interest on all bonds and other debt instruments issued by the County according to a pre-determined payment schedule.

EMPLOYEE BENEFITS

Amounts paid to or on behalf of employees but not included in the salary. Examples are group health or life insurance payments, contributions to employee retirement, Social Security taxes, Workers' Compensation payments, and Unemployment Insurance payments.

ENCUMBRANCE

An obligation in the form of a purchase order, contract, or other commitment which is chargeable to an appropriation. Available appropriations are reduced by the amount of outstanding encumbrances.

ENTERPRISE FUND

A fund established to account for certain functions which are primarily or partially supported by user charges. Natividad Medical Center is an Enterprise Fund.

EXPENDITURE

A payment made for goods delivered or services rendered during a fiscal year whether paid or unpaid at fiscal year-end. An expenditure occurs in a governmental fund.

FINAL BUDGET

The approved plan for appropriations and estimated revenues for a fiscal year. Also referenced as "Adopted Budget."

FISCAL YEAR

The twelve-month period on which financial

accounting is based. The fiscal year for Monterey County is July 1st through June 30th.

FUNCTION

A group of activities aimed at achieving an objective. For example, "Public Protection" is a function.

FUND

A fund is a fiscal and accounting entity; e.g., General Fund, Library Fund.

FUND BALANCE

Fund balance is an amount derived by the formula: "fund balance = assets – liabilities." All or a portion of this balance may be available to finance a succeeding year's budget.

GANN LIMIT

Annual appropriation limits established in accordance with Article XIII B of the California Constitution. Paul Gann, president of California Taxpayers Association, was instrumental in placing the amendment on the November 1978 ballot.

GASB

Governmental Accounting Standards Board which is currently the source of generally accepted accounting principles (GAAP) used by state and local governments in the United States.

GENERAL FUND

The fund that supports general County services.

GENERAL FUND CONTRIBUTION

Local non-program revenues such as property taxes, sales and use tax, and transient occupancy tax which the Board of Supervisors appropriates through the annual budget process to supplement departments' program-specific revenues.

GRANT

A payment or series of payments from one governmental unit to another for a specific purpose and time period, e.g., child abuse vertical protection program.

IMPREST FUNDS

A sum of money to be used as petty cash.

INTRA FUND TRANSFER

An intra fund transfer is a non-reciprocal transfer of resources by one department to another in the same fund.

INTER FUND TRANSFER

An inter fund transfer is a non-reciprocal transfer of

resources by one fund to another fund.

MEDI-CAL

The California Medical Assistance Program is the California Medicaid welfare program serving low-income families, seniors, persons with disabilities, children in foster care, pregnant women, and certain low-income adults.

NON-SPENDABLE FUNDS

Non-spendable funds are an amount that is not expected to be converted to cash such as inventories, prepaid items, long-term loans and notes receivable; or funds that are legally or contractually required to be maintained intact.

OBJECT TYPE OF EXPENDITURE

An object of expenditure is a major type of expenditure. For example: "Salaries and Benefits," "Services and Supplies," "Capital Assets" and "Other Charges."

OPERATING TRANSFER IN/OUT

The authorized transfer of funds from one fund/account/unit (Operating Transfer Out) to another made to support the normal level of operations of the receiving fund/account/ unit (Operating Transfer In).

REIMBURSEMENT

A reimbursement is a repayment from the funds responsible for expenditures to the funds that initially paid for them.

RESERVE

An amount set aside based on legal requirements.

RESTRICTED FUND

A fund is restricted when constraints are imposed on the use of resources by external creditors, grantors, contributors, or laws or regulations of other governments, or imposed by law through constitutional provisions of enabling legislation.

REVENUE

Money received which can be used to finance County operations. For example: property taxes, sales taxes, fees, and state and federal grants.

SALARY SAVINGS

The dollar amount of salaries saved due to position vacancies.

SCHEDULE

A "Schedule" is a listing of financial data in a form

and manner prescribed by a governing code, policy or standard.

SPECIAL DISTRICT

A dependent (under the Board of Supervisors) or independent unit of local government generally organized to perform a single function. Examples: street lighting, water works, fire protection.

SUBVENTION

Subventions are payments by an outside agency for specific costs which originate in the County.

TAX REVENUE ANTICIPATION NOTE

A note of short-term debt obligation issued by a state or local government with the understanding that a certain amount of taxes will be collected within an appreciable period of time.

TRANSIENT OCCUPANCY TAX

A California tax charged when occupying a room or other living space in a hotel, inn, motel, or other lodging for a period of less than 31 days.

UNASSIGNED FUNDS

This is the residual amount for the General Fund and represents fund balance that has not been restricted, committed, or assigned. The General Fund should be the only fund that reports a positive unassigned fund balance amount. The only classification that can report negative fund balances is the unassigned category.

USER CHARGES (USER FEES)

A fee for a public service paid by the party benefiting from the service.

VIACARE

The Monterey County Low Income Health Program which ended on December 31, 2013 as most members transitioned to Medi-Cal through the Central California Alliance for Health.



This page intentionally left blank.

Glossary of Acronyms

AAA	Area Agency on Aging	CCTA	California Coastal Trail Association
AAB	Assessment Appeals Board	CDBG	Community Development Block Grants
AAP	Adoption Assistance Program	CDCR	California Department of Corrections and Rehabilitation
AB	Assembly Bill	CDFA	California Department of Food and Agriculture
ACA	Affordable Care Act	CDS	County Disposal Site
ACAO	Assistant County Administrative Officer	CEQA	California Environmental Quality Act
ACFR	Annual Comprehensive Financial Report	CERBT	California Employers' Retiree Benefit Trust
ADA	Americans with Disabilities Act	CFD	Community Facilities District
ADU	Accessory Dwelling Unit	CFET	CalFresh Employment and Training
ADCR	Aging and Disability Resource Connection	CFP	County Facility Payment
AFDC	Aid to Families with Dependent Children	CHDP	Child Health Disability Prevention
ALAE	Allocated Loss Adjustment Expense	CHPS	Consumer Health Protection Services
AOC	Administration Office of the Courts	CIC	Capital Improvement Committee
ARC	Annual Required Contribution	CIMIS	California Irrigation Management Information System
APS	Adult Protective Services	CIP	Capital Improvement Projects
ARPA	American Rescue Plan Act	CJIS	Criminal Justice Information System
AVA	Actuarial Value of Assets	CJIS/SUSTAIN	Integration of the Criminal Justice Information System with the State Court's System (SUSTAIN)
BEYR	Budget End of Year Report	CLPPP	Childhood Lead Poisoning Prevention Program
BOS	Board of Supervisors	CMS	Case Management System
CACEO	California Association of Clerks and Elections Officials	CMS	Centers for Medicaid and Medicare
CAD	Computer Aided Dispatch	CNC	Creating New Choices
CAiAIM	California Advancing and Innovating Medi-Cal	COB	Clerk of the Board
CALA	Community Action Linking Adolescents	COB	Corrections Operations Bureau
CalFresh	Federally known as the Supplemental Nutrition Assistance Program	COBRA	Consolidated Omnibus Budget Reconciliation Act
CalPERS	California Public Employees Retirement System	COP	Certificates of Participation
CAO	County Administrative Office	COWCAP	Countywide Cost Allocation Plan
CAO	County Administrative Officer	CSA	County Service Area
CAP	Community Action Partnership	CSAC	California State Association of Counties
CAAH	Central California Alliance for Health	CSBG	Community Services Block Grant
CCCP	Criminal Court Collections Program	CUPA	Certified Unified Program Agency
CCR	Continuum of Care Reform	CWES	CalWORKs Welfare-to-Work Employment Services
CCS	California Children's Services		

CY	Current Year
CYE	Current Year Estimate
DA	District Attorney
DCSS	Department of Child Support Services
DEM	Department of Emergency Management
DHCS	California Department of Health Care Services
DJJ	Department of Juvenile Justice
DOJ	Department of Justice
DSA	Development Set-Aside
DSS	Department of Social Services
DWPS	Drinking Water Protection Services
EAP	Employee Assistance Program
EDD	Economic Development Department
EHR	Environmental Health Review Services
EMS	Emergency Medical Services
EOC	Emergency Operations Center
ERP	Enterprise Resource Planning
FC	Foster Care
FEMA	Federal Emergency Management Agency
FLSA	Fair Labor Standards Act
FOR A	Fort Ord Reuse Authority
RPPC	Fair Political Practices Commission
FQHC	Federally Qualified Health Center
FQHC-LA	Federally Qualified Health Center Look-Alike
FSA	Flexible Spending Account
FTE	Full Time Equivalent
FY	Fiscal Year
GAAP	Generally Accepted Accounting Principles
GA-WEP	General Assistance Work Experience Program
GFC	General Fund Contribution
GFOA	Government Finance Officers Association
GI Bill	Servicemen's Readjustment Act of 1944

GIS	Geographic Information Systems
GL	General Liability
GRM	Graduated Responses and Incentives Matrix
HAVA	Help America Vote Act
HCAHPS	Hospital Consumer Assessment of Healthcare Providers and Systems
HCD	Housing & Community Development
HEAP	Homeless Emergency Aid Program
HHAP	Homeless, Housing, Assistance, and Prevention Program
HICAP	Health Insurance Counseling and Advocacy Program
HMMS	Hazardous Materials Management Services
HNT	Hostage Negotiators
HR	Human Resources
HRD	Human Resources Department
HRM	Advantage Human Resources Management
HRSA	Health Resources and Services Administration
HVAC	Heating, Ventilation, and Air Conditioning
IAR	Inter Agency Review
IGLA	Intergovernmental and Legislative Affairs
IHSS	In-Home Support Services
ILP	Independent Living Program
ILS	Integrated Library System
IP	Internet Protocol
IRS	Internal Revenue Service
ISF	Internal Service Fund
ITD	Information Technology Department
JBCT	Jail Based Competency Treatment
JSORT	Juvenile Sex Offender Response Team
LAE	Loss Adjustment Expenses
LAFCO	Local Agency Formation Commission
LBAM	Light Brown Apple Moth
LEA	CalRecycle's Local Enforcement Agency

LEAP	Local Early Action Planning Grant
LMS	Learning Management System
LOD	Learning and Organizational Development
MEM	Microsoft Endpoint Manager
MCAP	Municipal Climate Action Plan
MCBC	Monterey County Business Council
MCCVB	Monterey County Convention and Visitors Bureau
MCFC	Monterey County Film Commission
MCFL	Monterey County Free Libraries
MCLE	Mandatory Continuing Legal Education
MCOE	Monterey County Office of Education
MDM	Mobile Device Management
MEM	Microsoft Endpoint Manager
MFA	Multi-Factor Authentication
MFF	Mobile Field Force
MOE	Maintenance of Effort
MOU	Memorandum of Understanding
MPI	Master Patient Index
MVA	Market Value of Assets
MVAO	Military and Veterans' Affairs Offices
NACO	National Association of Counties
NCRIC	Northern California Regional Intelligence Center
NCQA	National Committee for Quality Assurance
NFP	Nurse Family Partnership
NGEN	Next Generation Public Safety Radio System Project
NMC	Natividad Medical Center
NPDES	National Pollutant Discharge Elimination System
OCESA	Office of Community Engagement and Strategic Advocacy
OES	Office of Emergency Services
OET	Office of Employment and Training
OMB	Office of Management and Budget
OPEB	Other Post-Employment Benefits
PC	Penal Code

PCSD	Pajaro County Sanitation District
PD	Public Defender
PDO	Public Defender's Office
PEPRA	Public Employee's Pension Reform Act
PIC	Public Improvement Corporation
PMO	Project Management Office
PRIME	Public Hospital Redesign and Incentives
PSAP	Public Safety Answering Point
PTO	Paid Time Off
PWPF	Public Works, Facilities, and Parks
REAP	Regional Early Access Planning Grant
RFP	Request for Proposal
RLF	Revolving Loan Fund
RMA	Resource Management Agency
ROPS	Recognized Obligation Payment Schedule
RRRS	Recycling and Resource Recovery Services
SAFE	Sexual Assault Felony Enforcement
SAR	Search and Rescue Team
SART	Sexual Assault Response Team
SB	Senate Bill
SCRAMP	Sports Car Racing Association of the Monterey Peninsula
SIR	Self-Insured Retention
SOD	Sudden Oak Death
SRPS	Scenic Road Protective Structure
SSI	Supplemental Security Income
SSI/SSP	Supplemental Security Income/ State Supplementary Program
SSRC	Silver Star Resource Center
SUD	Substance Use Disorder
SWAT	Special Weapons and Tactical Team
SWMS	Solid Waste Management Services
TAMC	Transportation Agency for Monterey County
TANF	Temporary Assistance for Needy Families
TBD	To be determined

THPP	Transitional Housing Placement Program
TMDL	Total Maximum Daily Loads
TOT	Transient Occupancy Tax
TPA	Third Party Administrator
TTC	Treasurer-Tax Collector
UC	University of California
UCSF	University of California, San Francisco
ULAE	Unallocated Loss Adjustment Expense
UPS	Uninterruptable Power Supply
USDA	United States Department of Agriculture
VA	Veterans' Affairs
VAMP	Vehicle Asset Management Program
VHF	Very High Frequency
VLF	Vehicle License Fees
VRP	Vehicle Replacement Program
WAM	Weighted Average Maturity
WAN/LAN	Wide Area/Local Area Networks
WAP	Work Alternative Program
WDB	Workforce Development Board
WC	Workers' Compensation
WIA	Workforce Investment Act
WIOA	Workforce Innovation and Opportunity Act
WIB	Workforce Investment Board
WIC	Women, Infants and Children
WPC	Whole Person Care
YC	Youth Center

Glossary of Funds

001 - GENERAL: The general fund supports basic governmental functions including public safety, criminal justice, land use and environment, education, recreation, health and sanitation, public assistance, and finance and administration.

002 - ROAD FUND: A special fund for Road Services as required by State law. The Road Fund provides funding for road and bridge maintenance and construction activities. Major activities are traffic engineering, transportation planning, design and construction engineering of road improvements, development review, and maintenance and operation of County roads, bridges and utility infrastructure.

003 - LIBRARY FUND: Monterey County Free Libraries (MCFL) is a special taxing authority under the County Library Law of 1911 and, as such, its operations are funded primarily through its own share of property tax.

005 - IN-HOME SUPPORT SERVICES (IHSS): This fund provides for the cost of home care services to support the independence of aged, blind, and disabled persons, assisting them to live safely in their own home and community.

006 - FISH & GAME PROPAGATION FUND: This fund provides for the administration of the County's Fish and Game Commission. The Commission oversees the allocation of Fish and Game fine monies for grants to organizations and agencies undertaking fish and game wildlife propagation or educational projects.

008 - COMMUNITY ACTION PARTNERSHIP (CAP): This fund administers the Federal Community Services Block Grant. CAP contracts with community organizations to provide programs to advance and advocate for low-income and vulnerable populations.

009 - INCLUSIONARY HOUSING: This fund facilitates development of housing for lower and moderate-income residents. The Fund is capitalized through payment of in-lieu fees by developers of subdivision projects and repayment of project loans made from inclusionary funds.

011 - ECONOMIC DEVELOPMENT PROGRAM: This fund was established for the County's Small Business Revolving Loan Fund (RLF). The RLF supports the expansion, retention, and attraction of industry, commerce, and agriculture. Programs are

intended to help diversify and strengthen the economic base of the local area by assisting businesses that are unable to secure suitable private financing for start-up and expansion costs.

013 - COMMUNITY DEVELOPMENT FUND: This fund provides support for public infrastructure, community facilities and housing projects for very low, low, and moderate income households.

016 - EMERGENCY MEDICAL SERVICE FUND: This fund supports financing to plan, coordinate, and evaluate the countywide Emergency Medical Services (EMS) System. This includes maintaining countywide advance-life support services, contracting for ambulance and pre-hospital care services, monitoring and administering EMS training programs, planning for disaster medical response, and coordinating public information and education.

021 - WORKFORCE DEVELOPMENT BOARD: Facilitates the coordination between the public and private sector in focusing resources to effectively educate, train, and place individuals with the necessary resources and skill-set to meet employer demands.

022 - LOCAL REVENUE FUND: Pursuant to AB 109, this fund was created to receive sales tax revenue and vehicle license fee revenue in support of public safety realignment funds.

023 - BEHAVIORAL HEALTH: This fund is designated to recognize the use of funds mandated for mental health purposes.

024 - HOMELAND SECURITY GRANT: This fund provides for grant programs to support homeland security-related activities.

025 - HEALTH AND SOCIAL SERVICES: This fund is used to recognize Sales Tax Revenue, Vehicle License Fees, and Maintenance of Effort used for health and social services realignment.

026 - NGEN OPERATIONS & MAINTENANCE: This fund provides for the operations and maintenance cost of NGEN equipment.

027 - CLERK / RECORDER: This fund serves as the repository for the County Clerk/Recorder's restricted revenue solely for the use of modernization, micrographics, vital record, and electronic recording delivery system expenses.

028 – EMERGENCY COMMUNICATIONS: This fund contains the operations of emergency and non-emergency call answering services to law enforcement and fire agencies in the County.

029 – HABITAT MANAGEMENT PROGRAM: Per the Joint Community Facilities Agreement between Fort Ord Reuse Authority (FORA) and the County, this fund segregates Habitat Management allocated funds to provide habitat related services within or in FORA’s Basewide Community Facilities District (CFD) in perpetuity.

030 – PENSION TRUST: This fund was established for the collection of unfunded accrued liability (UAL) supplemental pension payments to address the County’s unfunded pension liability. Contributions from the supplemental payments are held in a Section 115 Trust with an external trust administrator.

051 - CSA 1 CARMEL POINT: This fund provides support for the streetlight system.

052 - CSA 9 OAK PARK: This fund provides support for the storm drainage & streetlight systems.

053 - CSA 10 LAGUNA SECA RANCH: This fund provides support for wastewater reclamation.

056 - CSA 15 SERRA VILLAGE, TORO PARK: This fund provides support for the storm drainage, Min-Parks, Open Space, & streetlight systems.

057 - CSA 17 RANCHO TIERRA GRANDE: This fund provides support for the Open Space Fire Maintenance system.

058 - CSA 19 CARMEL MEADOWS: This fund provides support for the streetlight system.

059 - CSA 20 ROYAL ESTATES: This fund provides support for the storm drainage & streetlight systems.

060 - CSA 23 CARMEL RANCHO: This fund provides support for the storm drainage, streetlight, parkway maintenance, & sidewalk maintenance systems.

061 - CSA 24 PEDRAZZI SUBDIVISION /INDIAN SPRINGS: This fund provides support for the storm drainage system.

062 - CSA 25 CARMEL VALLEY GOLF & COUNTRY CLUB: This fund provides support for the storm drainage & streetlight systems.

063 - CSA 26 NEW MOSS LANDING HEIGHTS: This fund provides support for the streetlight system.

064 - CSA 30 RANCHO MAR MONTE: This fund provides support for the storm drainage system.

065 - CSA 31 AROMAS HILLS SUBDIVISION: This fund provides support for the storm drainage system.

066 - CSA 32 GREEN VALLEY ACRES/MOON SUBDIVISION: This fund provides support for the storm drainage & streetlight systems.

067 - CSA 33 COAST RIDGE/CARMEL SUR: This fund provides support for the storm drainage system.

068 - CSA 34 RANCHO RIO VISTA/CARMEL KNOLLS: This fund provides support for the storm drainage system.

069 - CSA 35 PARADISE PARK/RANCHO BORROMEO: This fund provides support for the storm drainage & streetlight systems.

070 - CSA 37 COLONIAL OAK ESTATES: This fund provides support for the storm drainage system.

071 - CSA 38 PARADISE LAKE ESTATES: This fund provides support for the storm drainage system.

072 - CSA 41 GABILAN ACRES/BORONDA: This fund provides support for the streetlight system.

073 - CSA 44 CORRAL DE TIERRA OAKS: This fund provides support for the storm drainage & streetlight systems.

074 - CSA 45 OAK HILLS: This fund provides support for the storm drainage & streetlight systems.

075 - CSA 46 OAK HILLS - OPEN SPACE: This fund provides support for the Open Space systems.

076 - CSA 47 CARMEL VIEWS/MAR VISTA: This fund provides support for the storm drainage & streetlight systems.

077 - CSA 50 RIOWAY TRACK NO.2: This fund provides support for the storm drainage & flood control systems.

078 - CSA 51 HIGH MEADOWS: This fund provides support for the storm drainage & streetlight systems.

079 - CSA 52 CARMEL VALLEY VILLAGE: This fund provides support for the storm drainage system.

080 - CSA 53 ARROYO SECO: This fund provides support for the storm drainage system.

081 - CSA 54 MANZANITA/SARSI SUBDIVISIONS: This fund provides support for the storm drainage system.

082 - CSA 55 ROBLES DEL RIO: This fund provides support for the storm drainage system.

083 - CSA 56 DEL MESA CARMEL: This fund provides support for the storm drainage & fire roads systems.

084 - CSA 57 LOS TULARES SUBDIVISION: This fund provides support for the storm drainage & Open Space systems.

085 - CSA 58 VISTA DORADO: This fund provides support for the storm drainage & streetlight systems.

086 - CSA 62 RANCHO DEL MONTE 14: This fund provides support for the storm drainage system.

087 - CSA 66 OAK TREE VIEWS: This fund provides support for the storm drainage, Open Space, playground, street maintenance & streetlight systems.

088 - CSA 67 CORRAL DE TIERRA OAKS 4: This fund provides support for the storm drainage & streetlight systems.

089 - CSA 68 VIERRA CANYON KNOLLS: This fund provides support for the storm drainage system.

090 - CSA 69 RALPH LANE: This fund was established to provide sanitation services; however, most the parcels were detached, and services are being provided by Cal Water. There are no services currently being provided.

091 - CSA 72 LAS PALMAS RANCH: This fund provides support for the storm drainage system.

092 - CSA 74 AMBULANCE: This fund provides support for County ambulance service.

093 - CSA 75 CHUALAR CONSOLIDATED: This fund provides support for the wastewater collection & treatment, streetlights, and storm drainage systems.

151 - PAJARO COUNTY SANITATION DISTRICT: This fund provides support for the wastewater collection system.

154 - CARMEL VALLEY COUNTY SANITATION DISTRICT: This fund provides support for the Carmel Valley Sanitation Zone #2 District.

156 - BORONDA COUNTY SANITATION DISTRICT: This fund provides support for the wastewater collection system.

157 - SAN JERARDO: This fund provides support for the water system, part of the Boronda County Sanitation District.

175 - CASTROVILLE-PAJARO HOUSING SET-ASIDE: The Castroville-Pajaro Housing Set-Aside fund contains tax increment revenues that provide support for very low, low and moderate income housing in the Castroville-Pajaro Project Area in accordance with California Redevelopment Law. Assigned to Successor Agency.

176 - BORONDA HOUSING SET-ASIDE: The Boronda Housing Set-Aside fund contains tax increment revenues that provide support for very low, low and moderate income housing in the Boronda Project Area in accordance with California Redevelopment Law. Assigned to Successor Agency.

177 - FORT ORD HOUSING SET-ASIDE: The Fort Ord Housing Set-Aside fund contains tax increment revenues that provide support for very low, low and moderate income housing in the Fort Ord Project Area in accordance with California Redevelopment Law. Assigned to Successor Agency.

178 - EAST GARRISON HOUSING SET-ASIDE: The East Garrison Housing Set-Aside fund contains tax increment revenues that provide support for very low, low and moderate income housing in the East Garrison portion of the Fort Ord Project Area in accordance with California Redevelopment Law. Assigned to Successor Agency.

180 – EAST GARRISON PUBLIC FINANCING

AUTHORITY: This fund includes funding for activities undertaken by the East Garrison Public Financing Authority, including the formation and operation of a Community Facilities District to finance the acquisition, construction and operation of public capital facilities in East Garrison.

181 – EAST GARRISON COMMUNITY FACILITY

DISTRICT: This fund includes funding for activities to own, operate, and maintain designated municipal infrastructure within the East Garrison Development Project.

182 – EAST GARRISON DEVELOPER

REIMBURSEMENTS: This fund is used to track the expenditures and reimbursement receipts of the East Garrison Developer when performing project administration or land use activities associated with the development.

251 - PUBLIC IMPROVEMENT CORPORATION

DEBT SERVICE: This fund funds debt payments and related expenses for Certificates of Participation issued by the Public Improvement Corporation.

305 - BORONDA COUNTY SANITATION SEWER

REVENUE: This Bond Revenue Fund is used for sanitation for Boronda County Sanitation District - Fund Balance transferred to BCSD in October 2010.

306 - BORONDA COUNTY SANITATION

REVENUE BOND: This Bond Revenue Fund is used for sanitation for Boronda County Sanitation District.

310 - PAJARO COUNTY SANITATION SEWER

REVENUE: This Bond Revenue Fund is used for sanitation for Pajaro County Sanitation District.

312 - CHUALAR COUNTY WATER SERVICE

AREA: This Bond Revenue Fund is used for streets in Chualar County Service Area.

404 – CAPITAL PROJECTS:

The Capital Projects Fund tracks the construction costs of new County facilities and major renovations.

405 – NGEN RADIO PROJECT:

This fund supports the County’s activities as the lead agency for the Next Generation (NGEN) Radio Project.

406 – REDEVELOPMENT OBLIGATION

RETIREMENT FUND: This fund facilitates the payment of enforceable Redevelopment Agency obligations after the passage of ABx1 26 dissolved the Agency.

451 – NATIVIDAD MEDICAL CENTER:

This Enterprise fund is for Natividad Medical Center operations.

452 - LAKE AND RESORT OPERATIONS:

This Enterprise fund is for Lake Nacimiento and Lake San Antonio Resorts operations.

453 – LAGUNA SECA RECREATIONAL AREA:

This Enterprise Fund is for the Laguna Seca Recreational Area operations.

475 - GENERAL LIABILITY:

The General Liability Internal Service Fund (ISF) contains expenses related to General Liability Insurance claims, settlements, judgments, administration, legal defense costs, and excess insurance premiums.

476 – WORKERS’ COMP FUND:

The Workers' Compensation Internal Service Fund contains expenses related to Workers’ Compensation claims, settlements, judgments, administration, legal defense costs, and excess insurance premiums.

477 – BENEFIT PROGRAMS FUND:

The Benefits Internal Service Fund contains revenue and expenditures related to the County's self-insured programs such as dental and vision insurance, disability insurance, as well as miscellaneous benefits.

478 – RESOURCE PLANNING:

This fund provides funds for capital projects that require replacement, maintenance, or upgrades during the life of the asset. The fund serves to establish a capital funding process, generating funds over the life of an asset, and thereby minimizing fiscal impacts to operations.

541 – COLLECTIONS AND CLEARING FUND:

This fund is used to house monies that the County receives prior to being disbursed to external entities.